

Sectiunea 1 - Km 0+000
Ax-Traseul 1

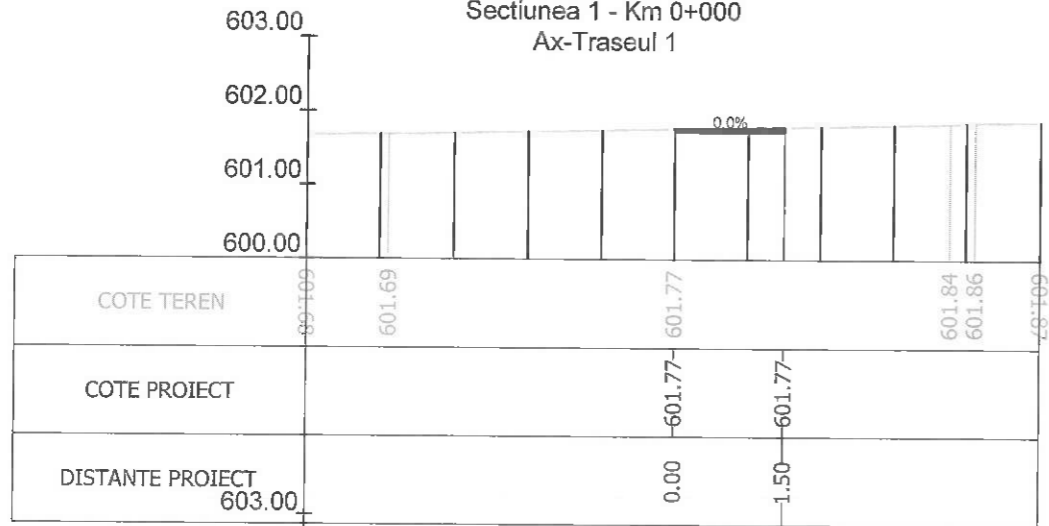

Sectiunea 2 - Km 0+000.595
Ax-Traseul 1

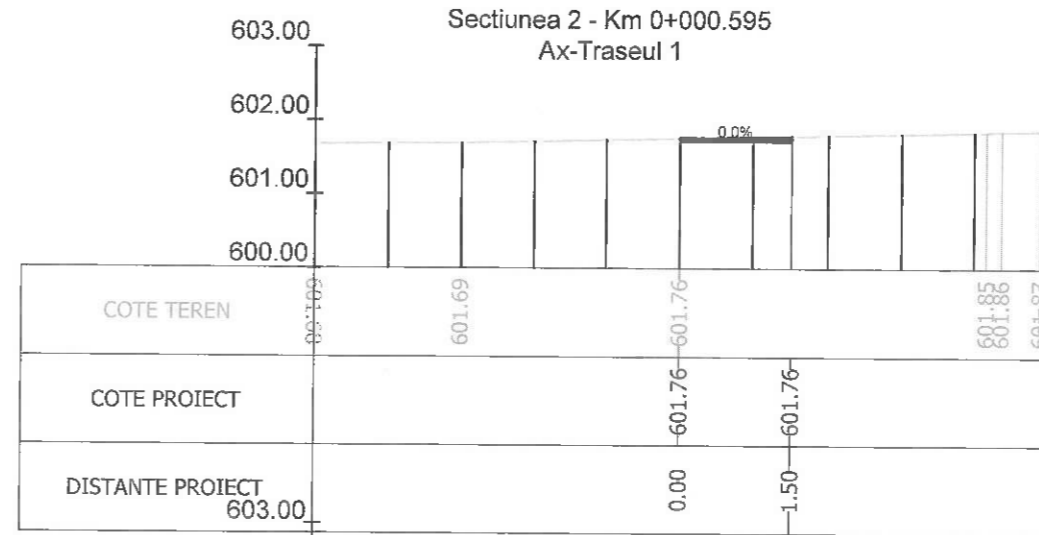

Sectiunea 3 - Km 0+001.469
Ax-Traseul 1

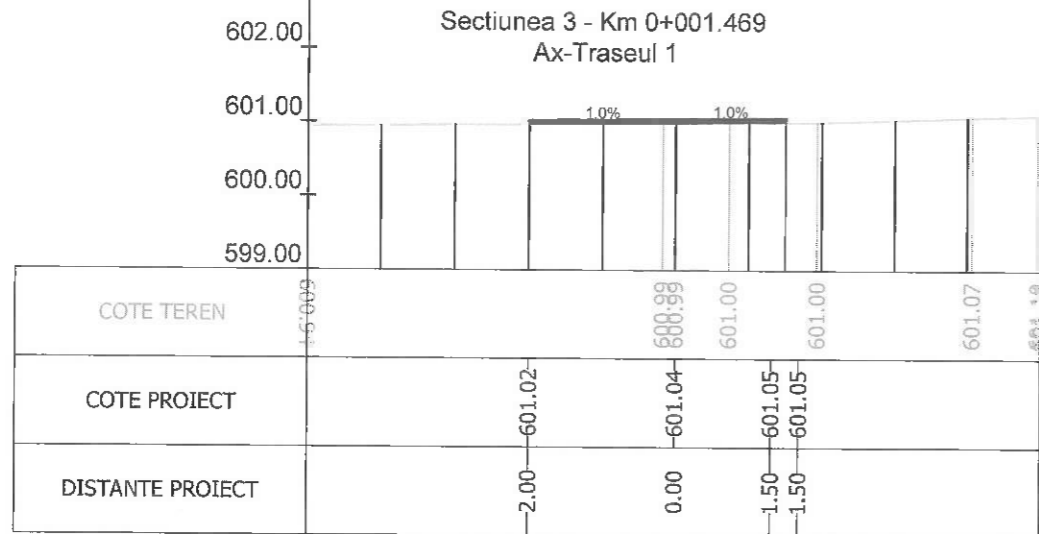

Sectiunea 4 - Km 0+002.343
Ax-Traseul 1

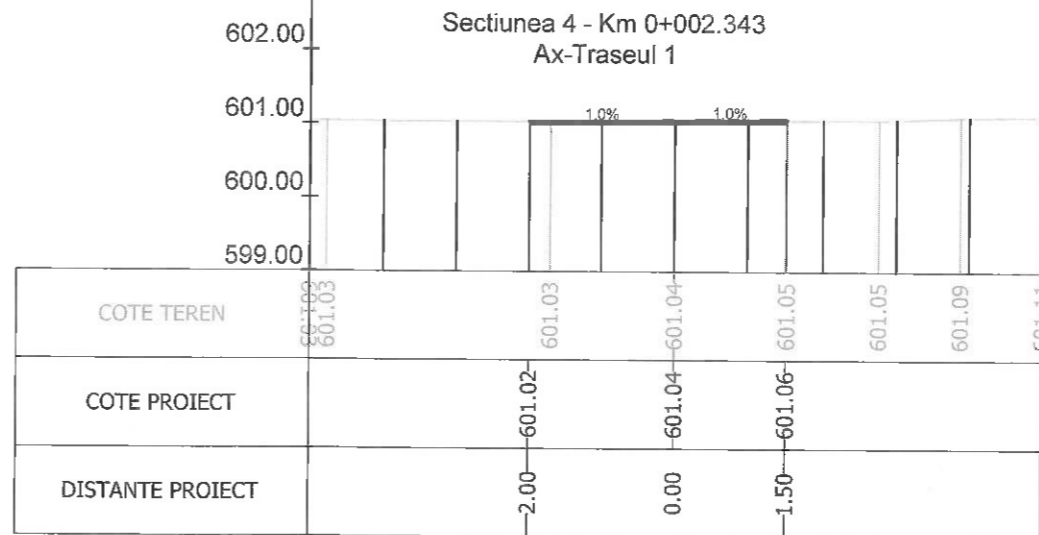

Sectiunea 23 - Km 0+137.064
Ax-Traseul 1

Sectiunea 24 - Km 0+145.480
Ax-Traseul 1

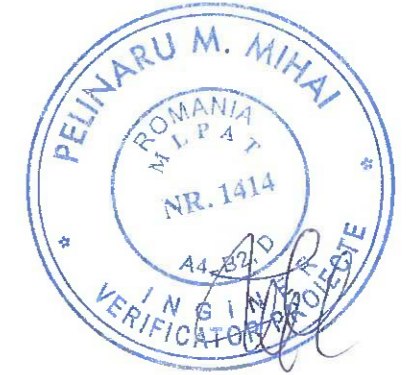

Index	Data	Observatii	Rev. 5
A			
		Beneficiar:	MUNICIPIUL BRASOV Bulevardul Eroilor 8, Brasov 500007
		Nr. proiect	73 / 2020
		Titlu proiect:	INFRASTRUCTURA INTEGRATA PENTRU CICLISM SI TRAFIC PIETONAL CU FACILITATI COMPLEMENTARE - TRASEUL 1
		Faza	P.T.
		Titlu plansa:	PROFILURI TRANSVERSALE TIP
		Nr. plansa	PTC 01
Sef Proiect	Ing. A. Buta	Scara	1:100
Proiectat	Ing. A. Buta	Data	07/2023
Desenat	Ing. S. Patroi		
Verificat			

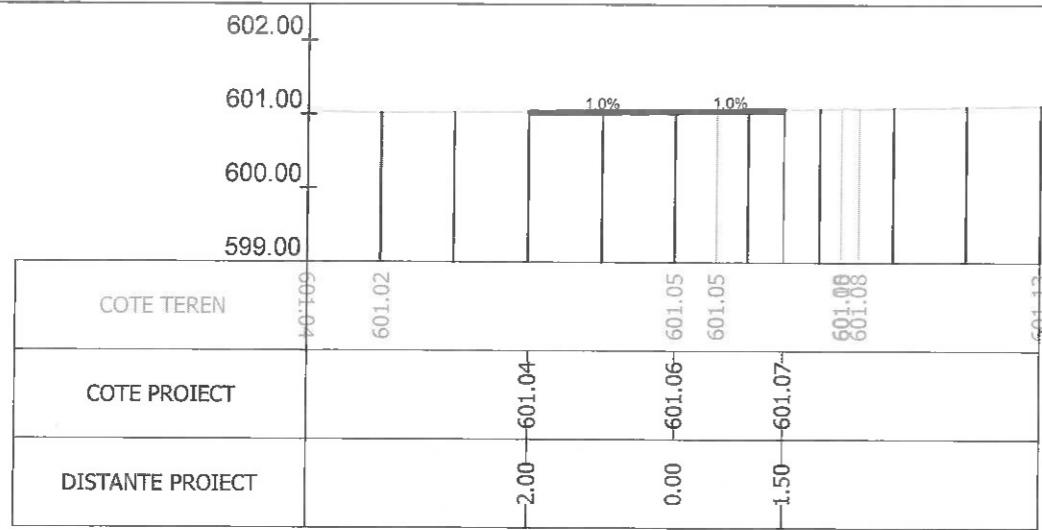

Sectiunea 25 - Km 0+150
Ax-Traseul 1

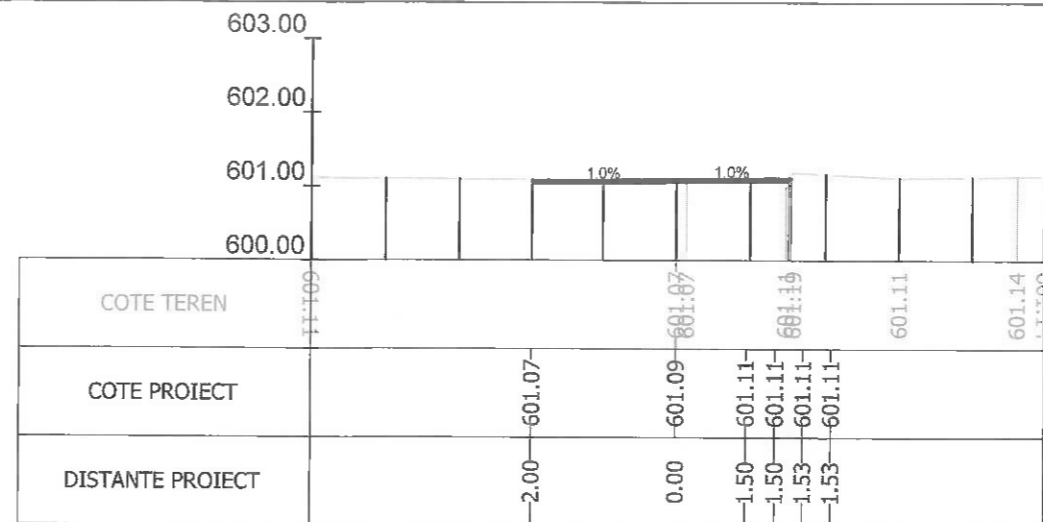

Sectiunea 26 - Km 0+153.895
Ax-Traseul 1

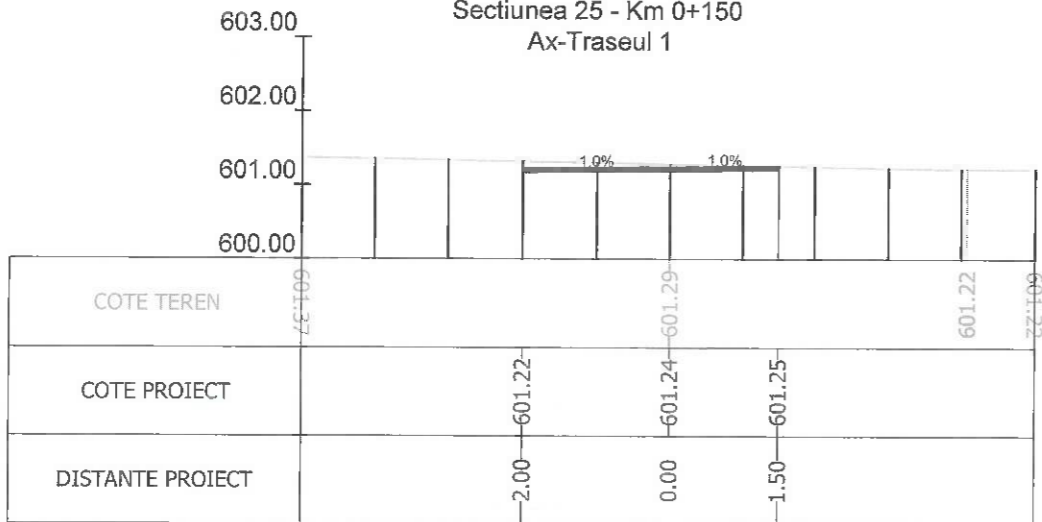
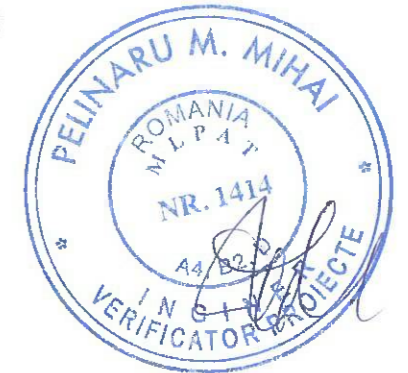

Sectiunea 27 - Km 0+167.278
Ax-Traseul 1

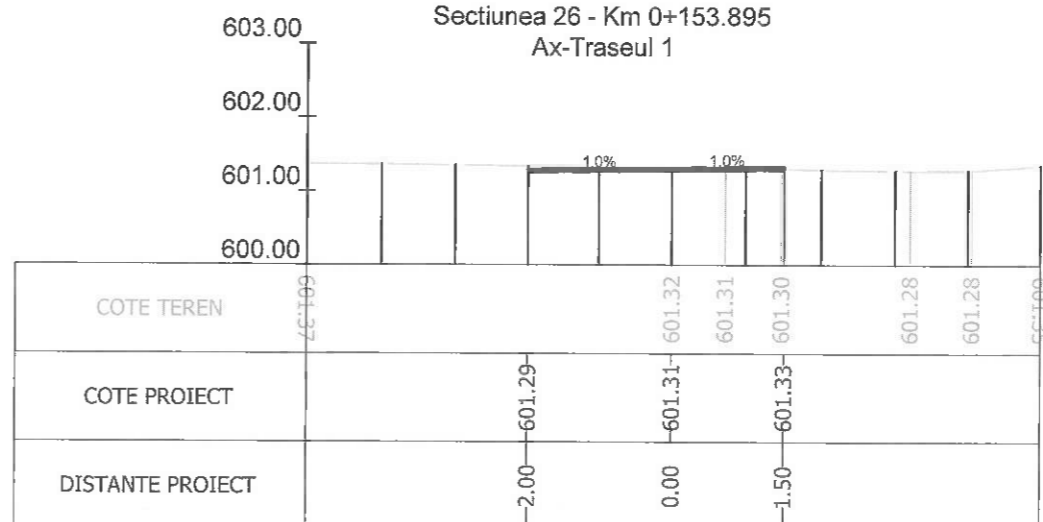

Sectiunea 28 - Km 0+175
Ax-Traseul 1

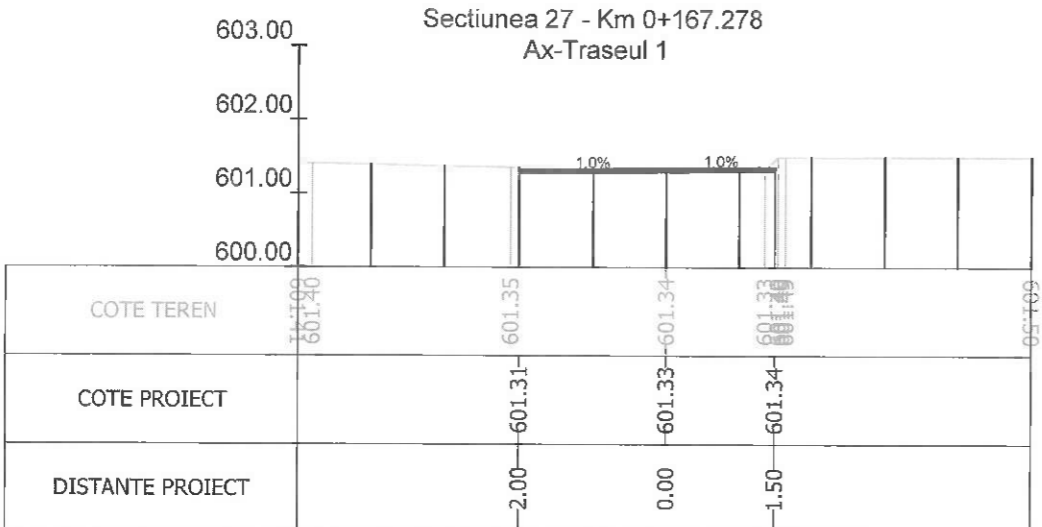

Sectiunea 29 - Km 0+180.661
Ax-Traseul 1

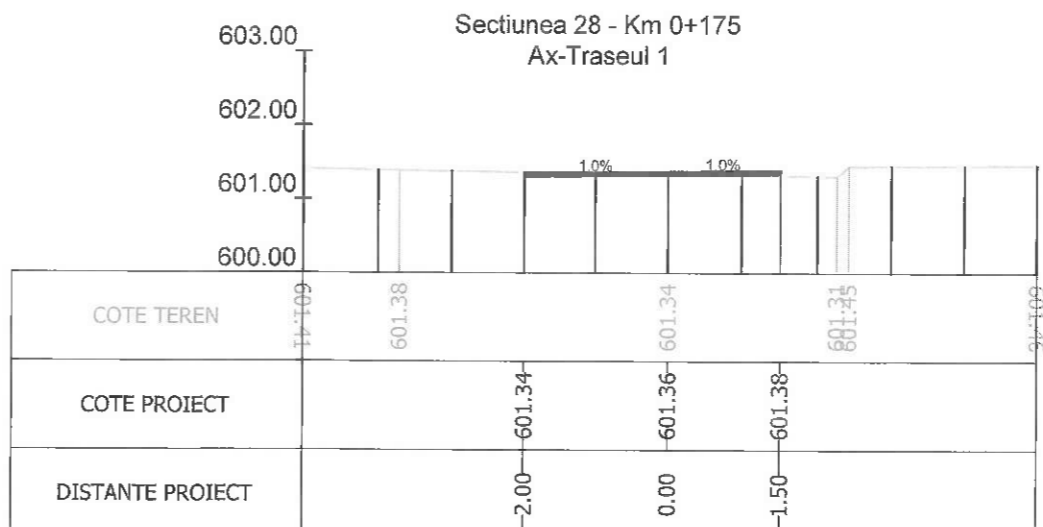

Sectiunea 30 - Km 0+200
Ax-Traseul 1

Index	Data	Observatii	Rev. 5
A			
		Beneficiar:	MUNICIPIUL BRASOV Bulevardul Eroilor 8, Brasov 500007
		Nr. proiect	73 / 2020
Sef Proiect	Ing. A. Buta	Titlu proiect:	INFRASTRUCTURA INTEGRATA PENTRU CICLISM SI TRAFIC PIETONAL CU FACILITATI COMPLEMENTARE - TRASEUL 1
Proiectat	Ing. A. Buta	Faza	P.T.
Desenat	Ing. S. Patroi	Titlu plansa:	PROFILURI TRANSVERSALE TIP
Verificat		Nr. plansa	PTC 02
		Scara	1:100
		Data	07/2023

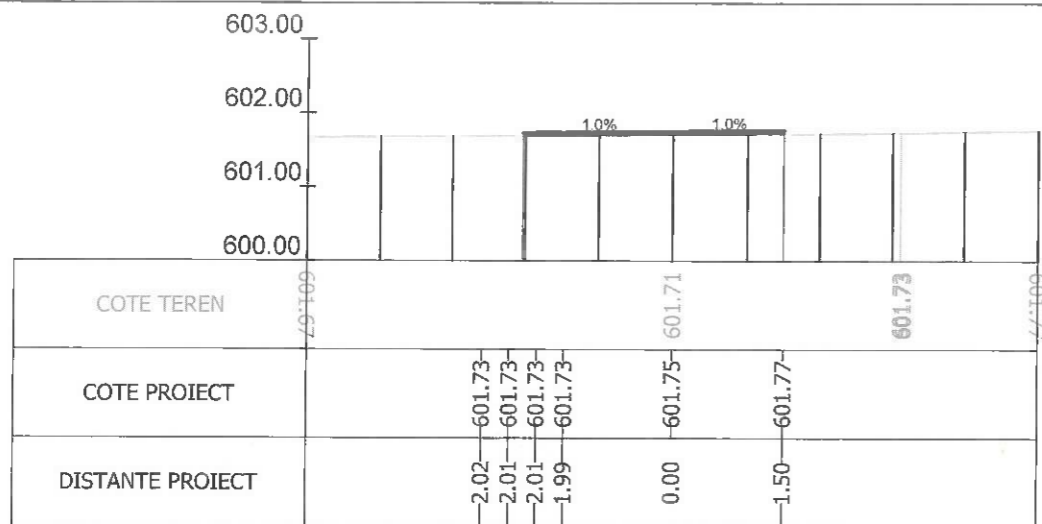

Sectiunea 39 - Km 0+266.560
Ax-Traseul 1

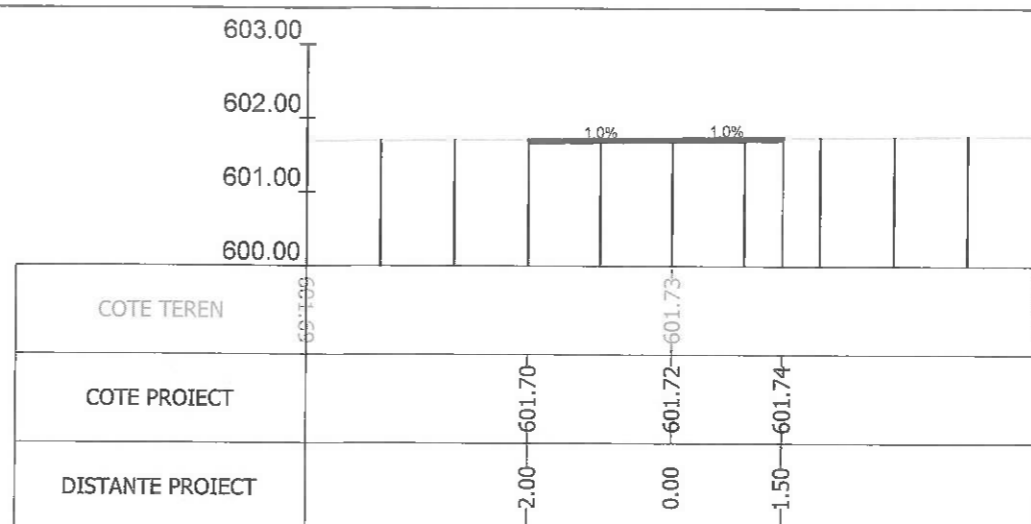

Sectiunea 40 - Km 0+275
Ax-Traseul 1

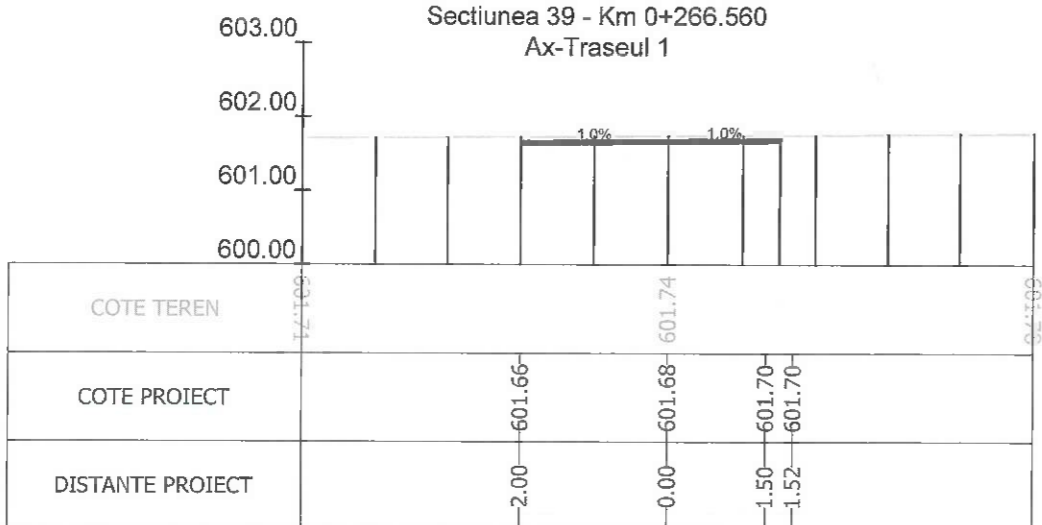

Sectiunea 41 - Km 0+279.409
Ax-Traseul 1

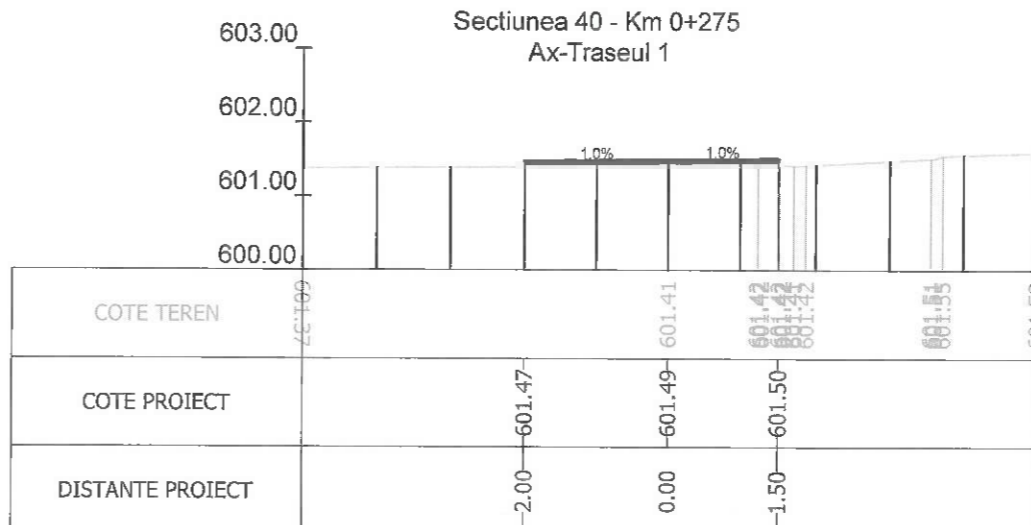

Sectiunea 42 - Km 0+292.259
Ax-Traseul 1

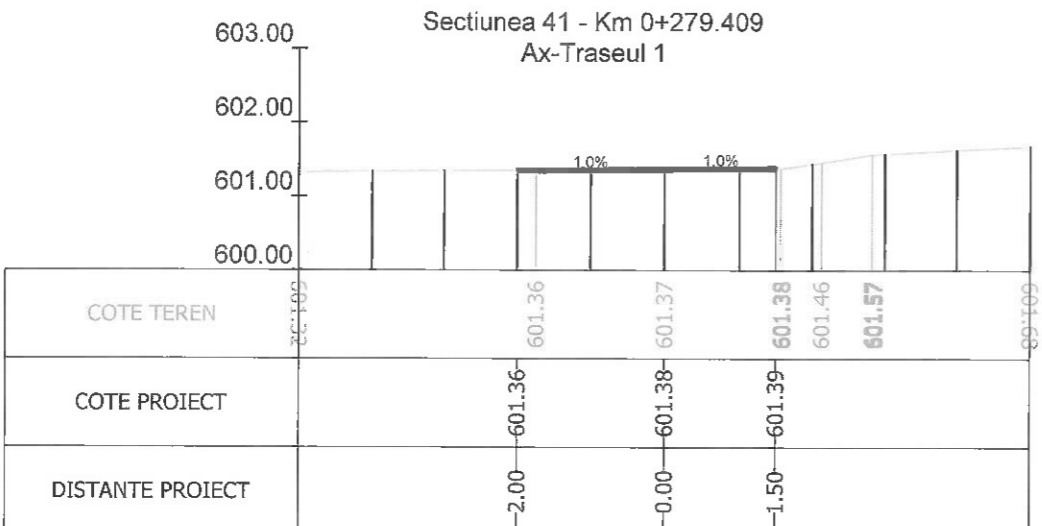

Sectiunea 43 - Km 0+300
Ax-Traseul 1

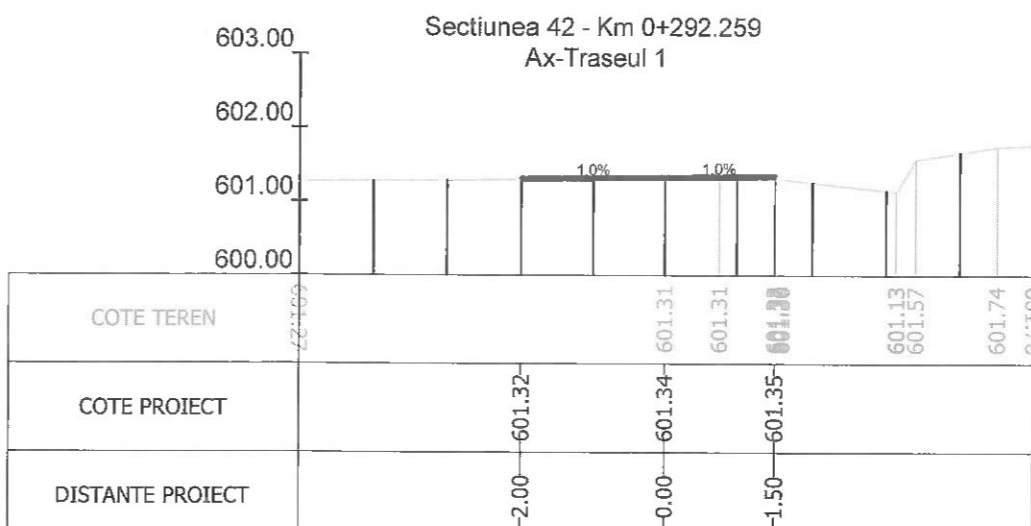

Sectiunea 44 - Km 0+309.462
Ax-Traseul 1



Index	Data	Observatii	Rev. 5
A			
		Beneficiar:	MUNICIPIUL BRASOV Bulevardul Eroilor 8, Brasov 500007
		Nr. proiect	73 / 2020
		Titlu proiect:	INFRASTRUCTURA INTEGRATA PENTRU CICLISM SI TRAFIC PIETONAL CU FACILITATI COMPLEMENTARE - TRASEUL 1
		Faza	P.T.
		Titlu plansa:	PROFILURI TRANSVERSALE TIP
		Nr. plansa	PTC 03
Sef Proiect	Ing. A. Buta	Scara	1:100
Proiectat	Ing. A. Buta	Data	07/2023
Desenat	Ing. S. Patroi		
Verificat			

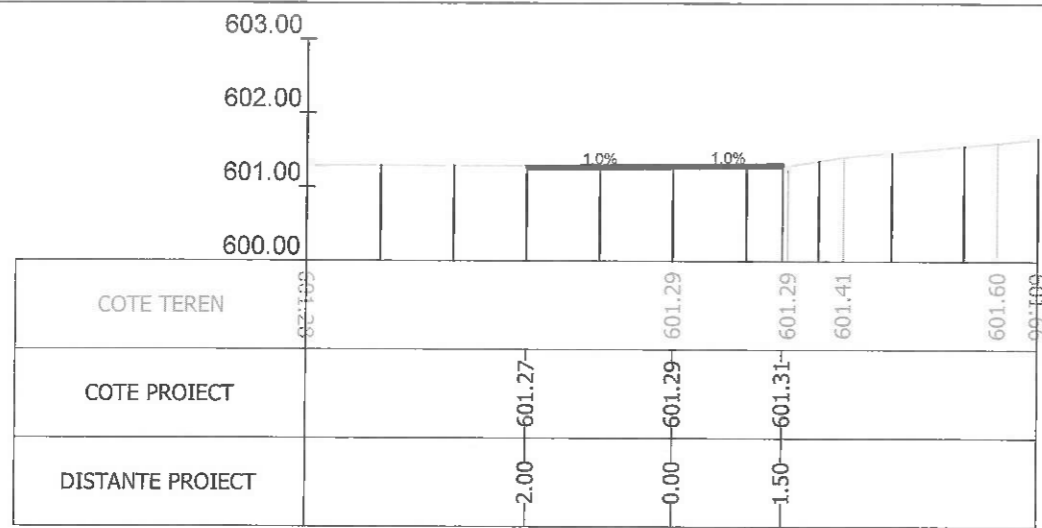

Sectiunea 45 - Km 0+325
Ax-Traseul 1

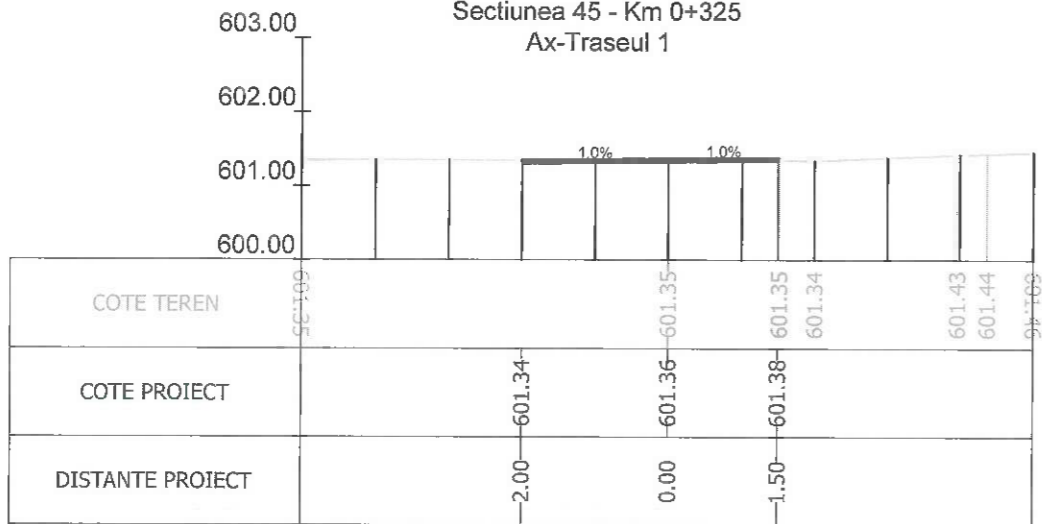

Sectiunea 46 - Km 0+326.666
Ax-Traseul 1

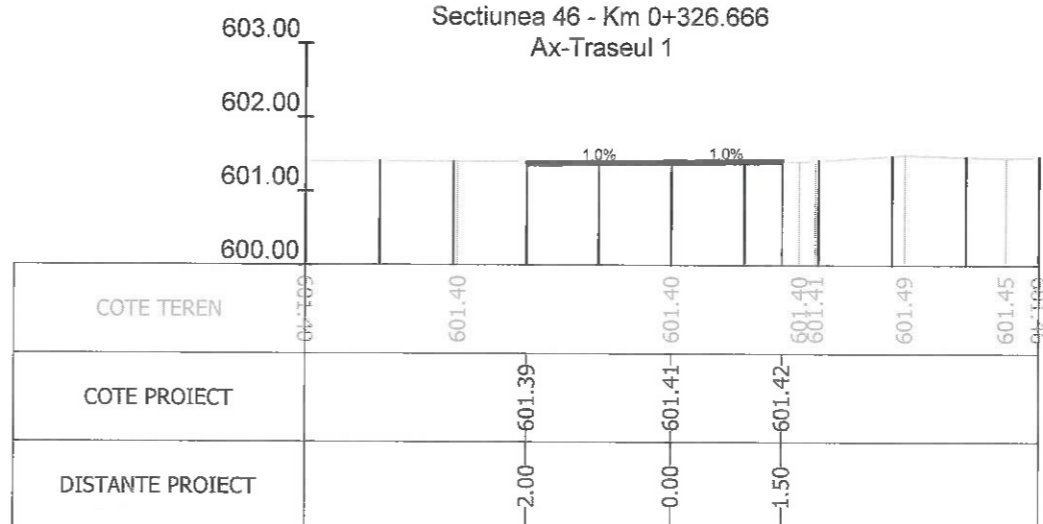

Sectiunea 47 - Km 0+340.703
Ax-Traseul 1

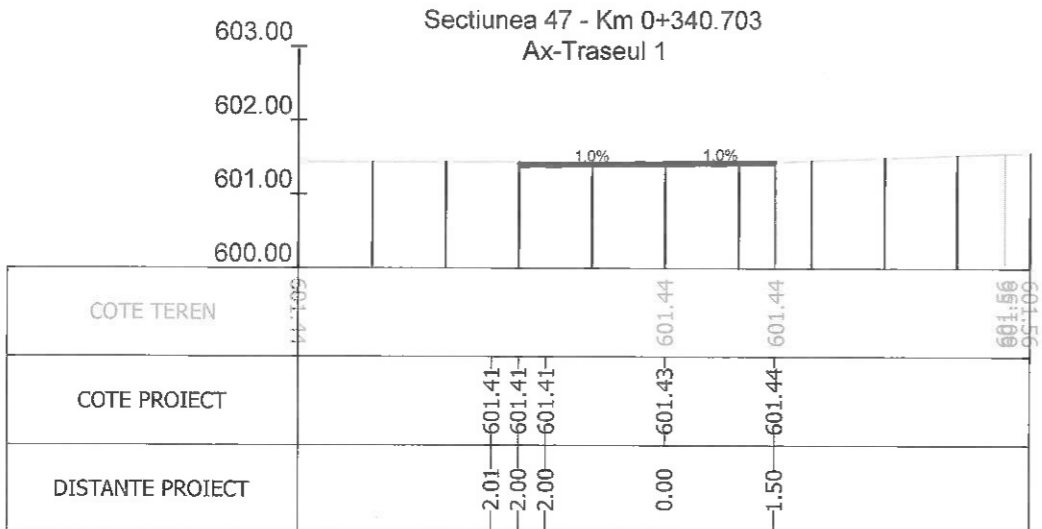

Sectiunea 48 - Km 0+350
Ax-Traseul 1

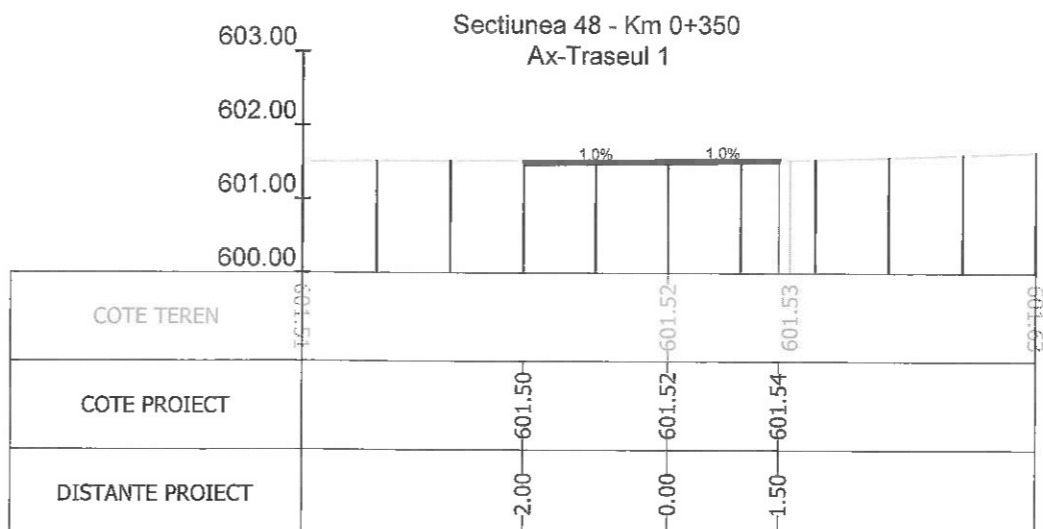

Sectiunea 49 - Km 0+354.741
Ax-Traseul 1

Sectiunea 50 - Km 0+375
Ax-Traseul 1

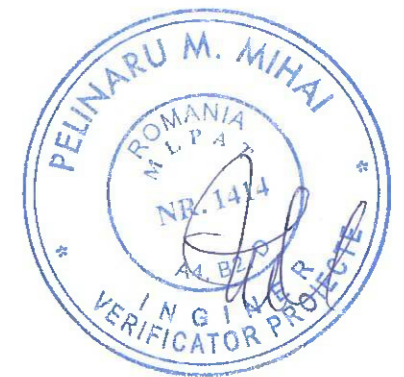

Index	Data	Observatii	Rev. 5
A			
		Beneficiar:	MUNICIPIUL BRASOV Bulevardul Eroilor 8, Brasov 500007
		Beneficiar:	MUNICIPIUL BRASOV Bulevardul Eroilor 8, Brasov 500007
		Titlu proiect:	INFRASTRUCTURA INTEGRATA PENTRU CICLISM SI TRAFIC PIETONAL CU FACILITATI COMPLEMENTARE - TRASEUL 1
		Titlu plansa:	PROFILURI TRANSVERSALE TIP
Sef Proiect	Ing. A. Buta	Scara	1:100
Proiectat	Ing. A. Buta	Data	07/2023
Desenat	Ing. S. Patroi		
Verificat			
			Nr. proiect 73 / 2020
			Faza P.T.
			Nr. plansa PTC 04

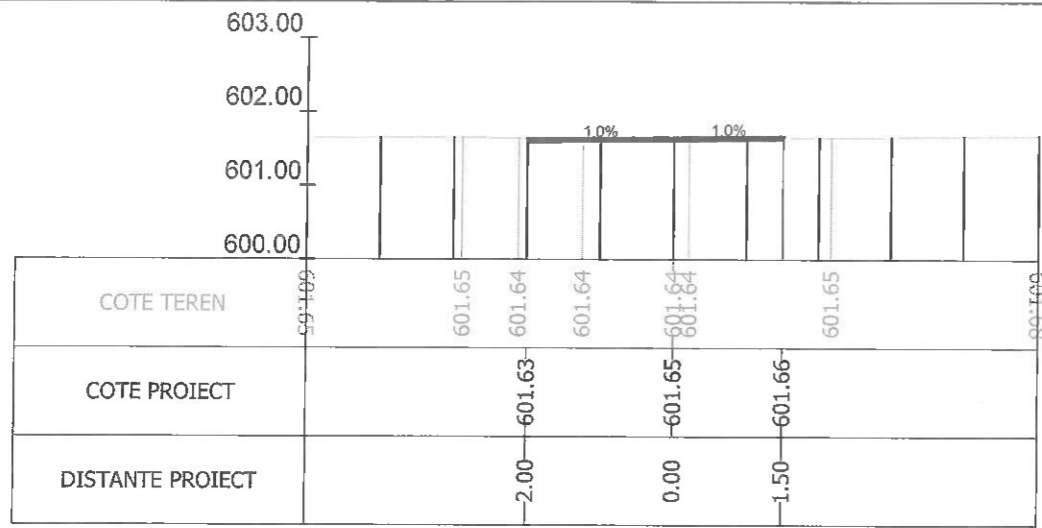

Sectiunea 57 - Km 0+433.231
Ax-Traseul 1

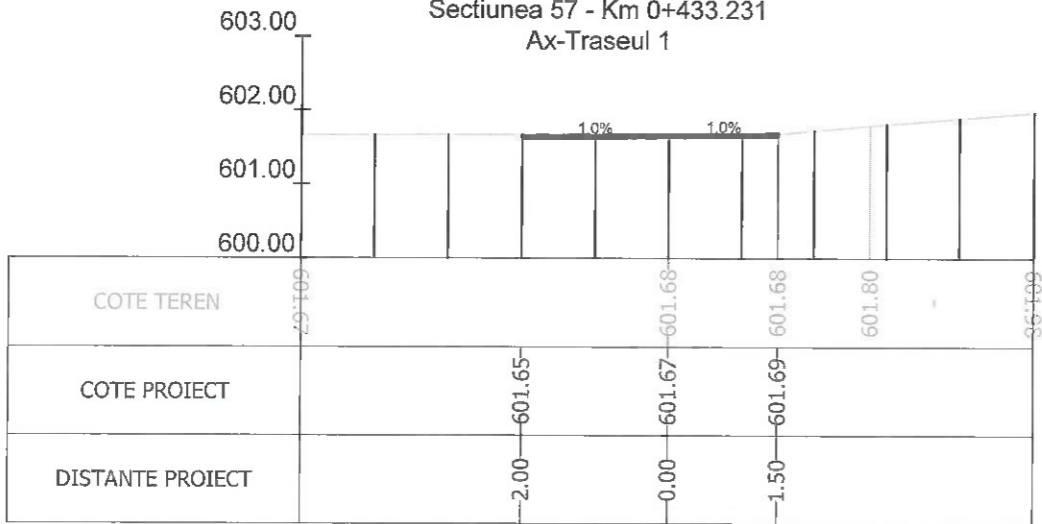

Sectiunea 58 - Km 0+448.871
Ax-Traseul 1

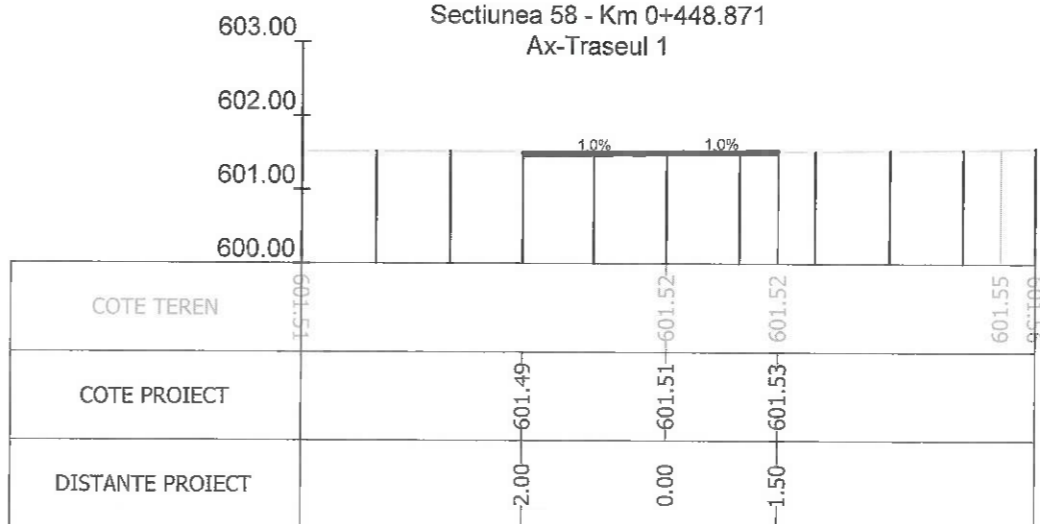

Sectiunea 60 - Km 0+475
Ax-Traseul 1

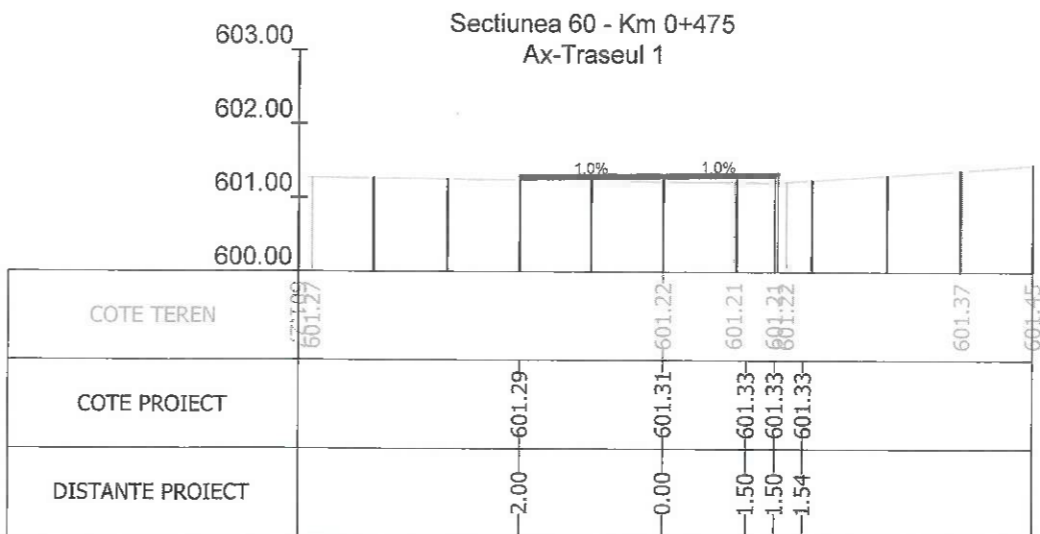

Sectiunea 61 - Km 0+500
Ax-Traseul 1

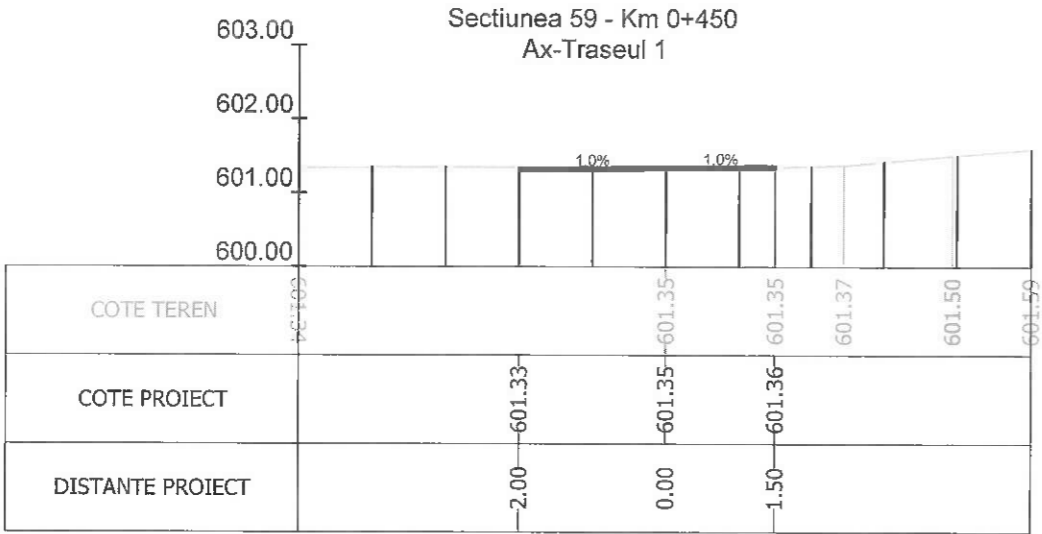

Sectiunea 62 - Km 0+520.865
Ax-Traseul 1



Index	Data	Observatii		Rev. 5
A				
				Beneficiar: MUNICIPIUL BRASOV Bulevardul Eroilor 8, Brasov 500007
Sef Proiect: Ing. A. Buta Proiectat: Ing. A. Buta Desenat: Ing. S. Patroi Verificat:		Scara: 1:100 Data: 07/2023		Nr. proiect: 73 / 2020 Faza: P.T. Nr. plansa: PTC 06
Titlu proiect: INFRASTRUCTURA INTEGRATA PENTRU CICLISM SI TRAFIC PIETONAL CU FACILITATI COMPLEMENTARE - TRASEUL 1 Titlu plansa: PROFILURI TRANSVERSALE TIP				

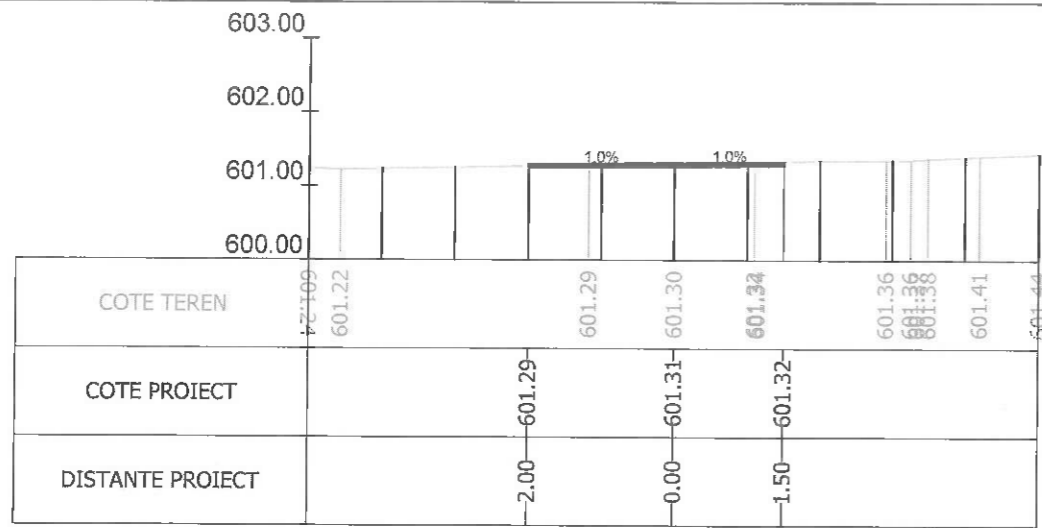

Sectiunea 63 - Km 0+525
Ax-Traseul 1

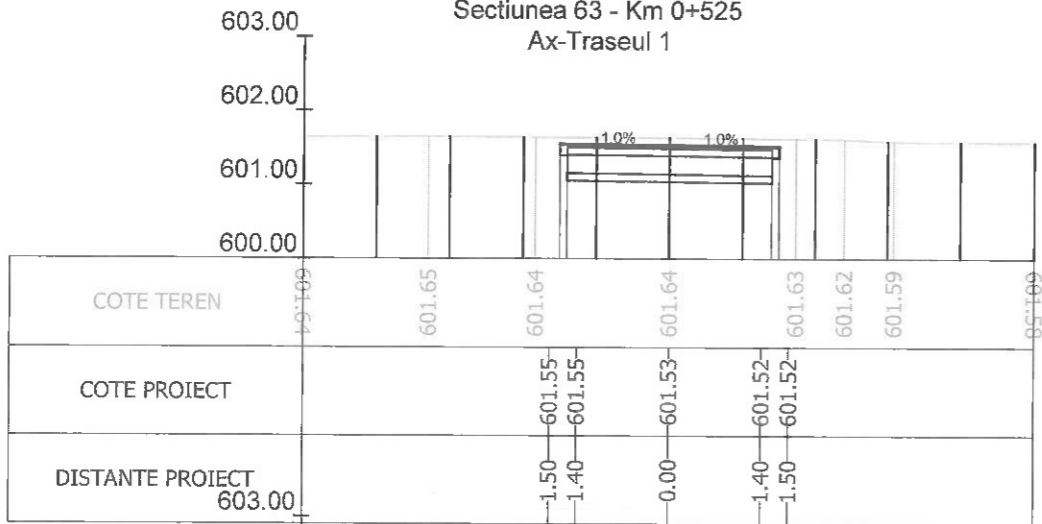

Sectiunea 102 - Km 1+098.964
Ax-Traseul 1

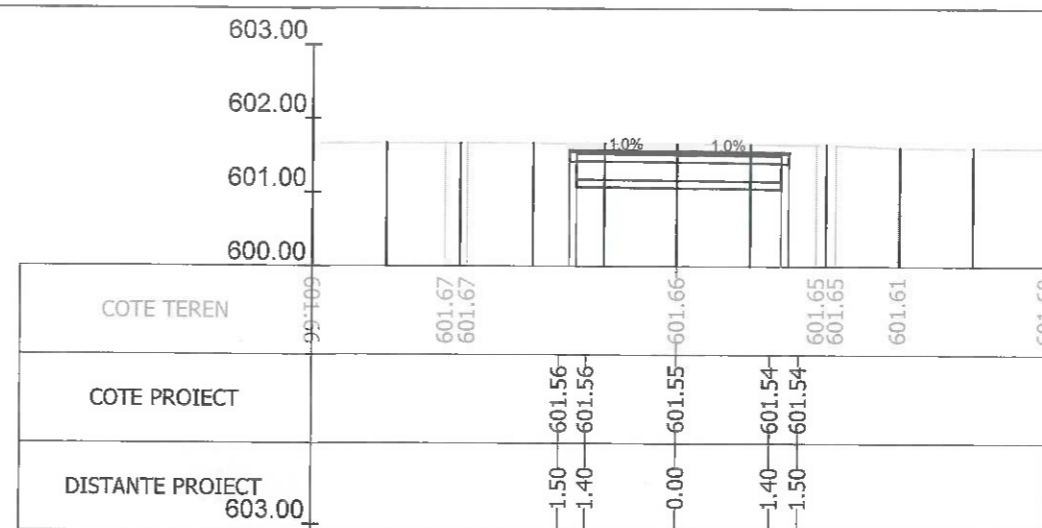

Sectiunea 104 - Km 1+125
Ax-Traseul 1

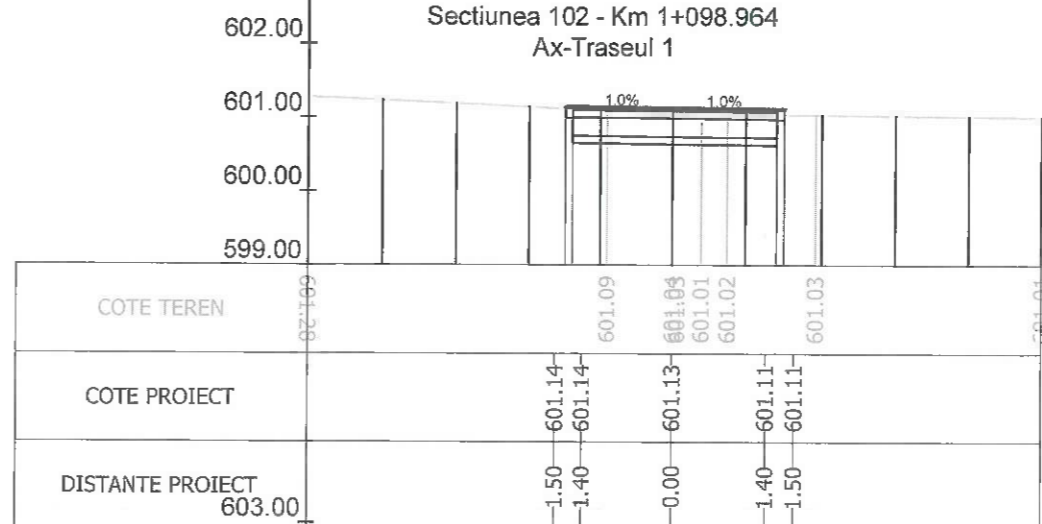

Sectiunea 105 - Km 1+127.060
Ax-Traseul 1

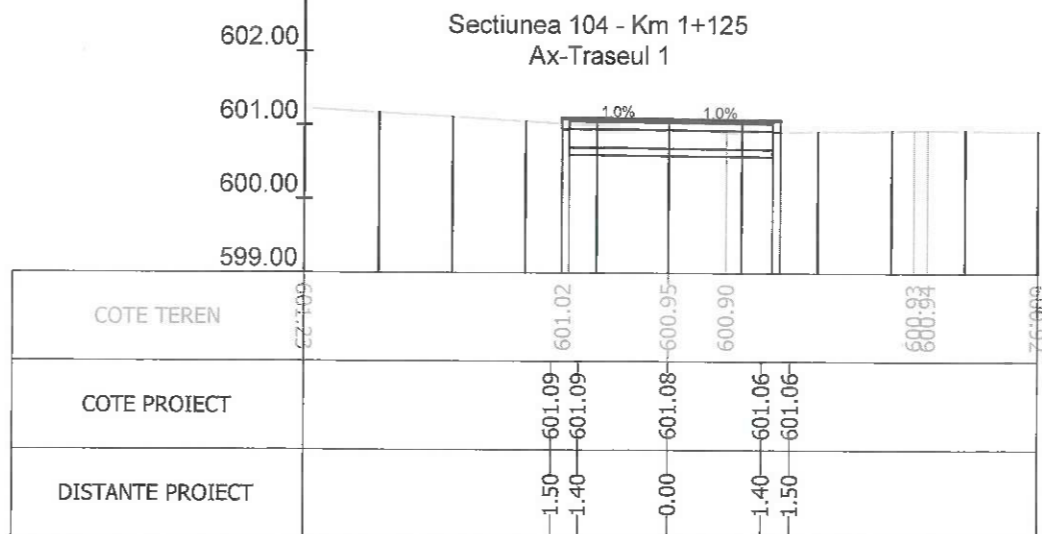

Sectiunea 106 - Km 1+128.024
Ax-Traseul 1

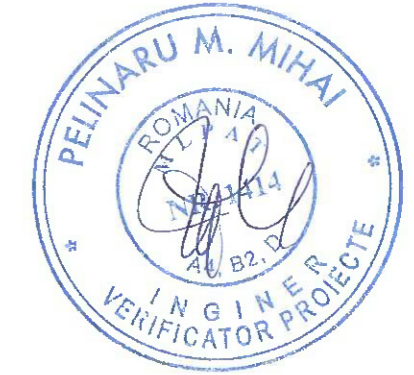

Index	Data	Observatii	Rev. 5
A			
		Beneficiar:	MUNICIPIUL BRASOV Bulevardul Eroilor 8, Brasov 500007
		Nr. proiect	73 / 2020
Sef Proiect: Ing. A. Buta Proiectat: Ing. A. Buta Desenat: Ing. S. Patroi Verificat:		Titlu proiect:	INFRASTRUCTURA INTEGRATA PENTRU CICLISM SI TRAFIC PIETONAL CU FACILITATI COMPLEMENTARE - TRASEUL 1
Scara: 1:100 Data: 07/2023		Faza	P.T.
		Titlu plansa:	PROFILURI TRANSVERSALE TIP
		Nr. plansa	PTC 07

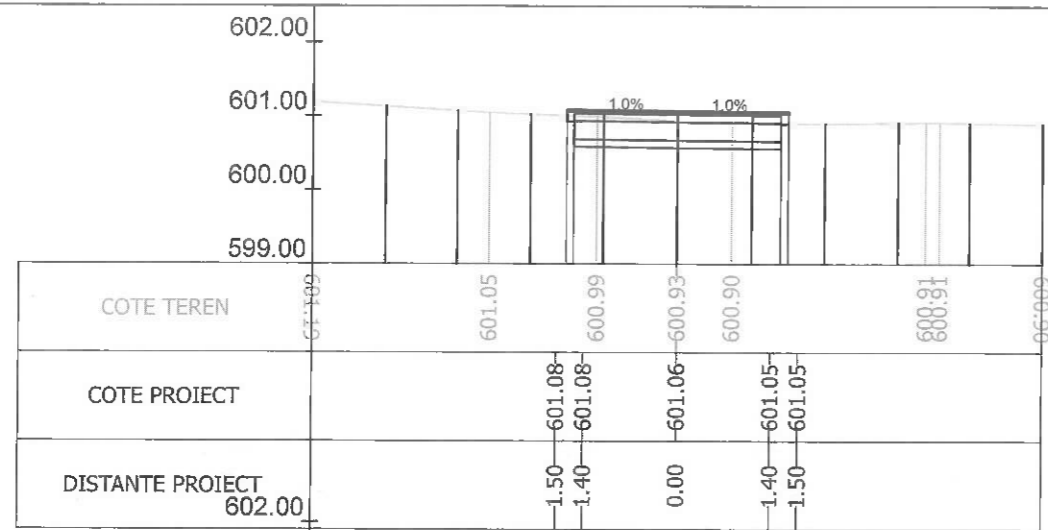

Sectiunea 107 - Km 1+128.989
Ax-Traseul 1

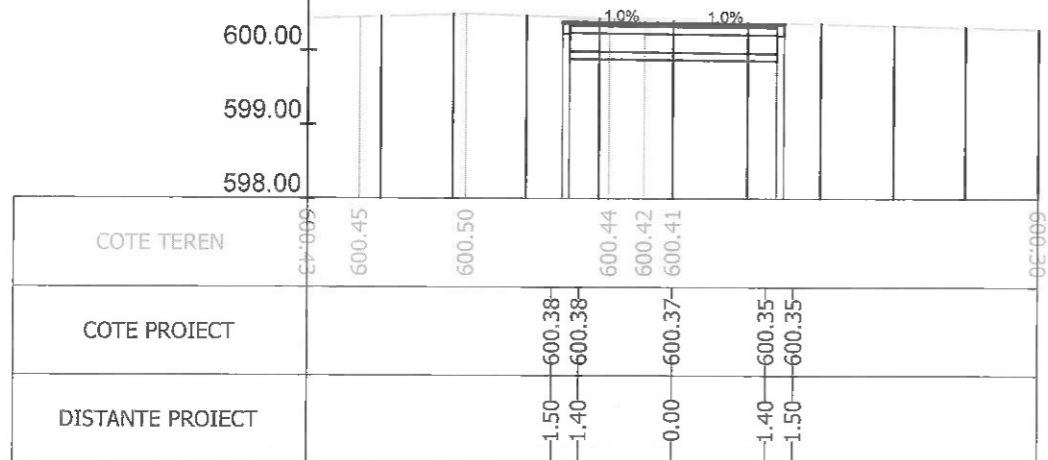

Sectiunea 109 - Km 1+175
Ax-Traseul 1

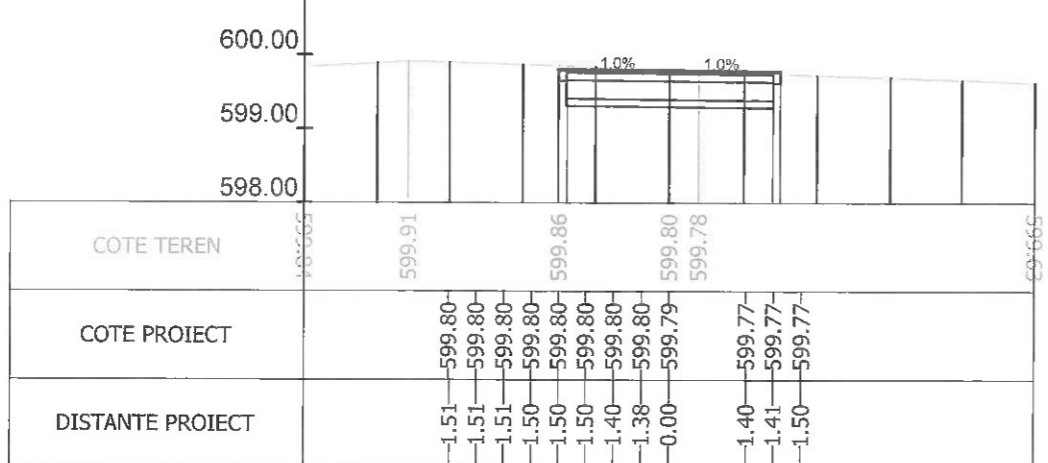

Sectiunea 111 - Km 1+216.073
Ax-Traseul 1

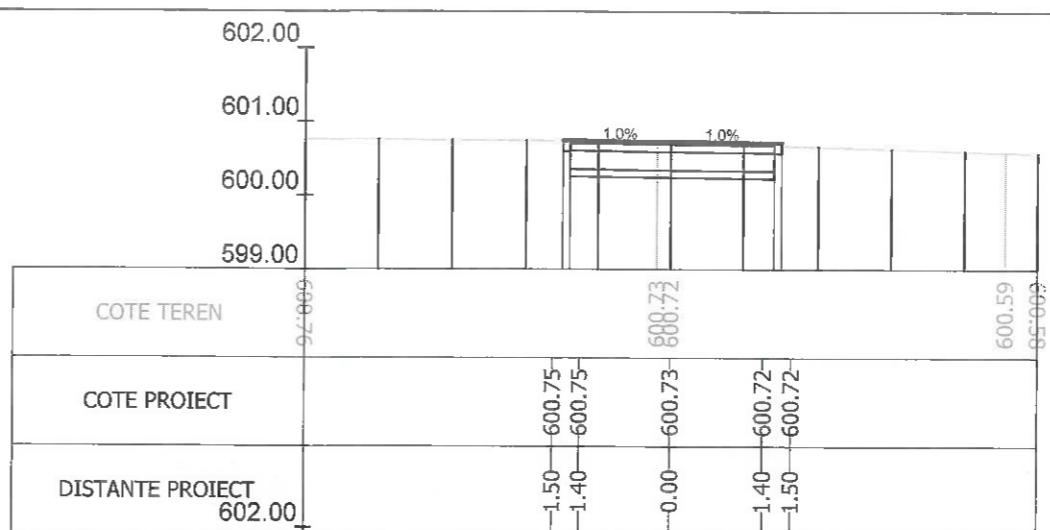

Sectiunea 108 - Km 1+150
Ax-Traseul 1

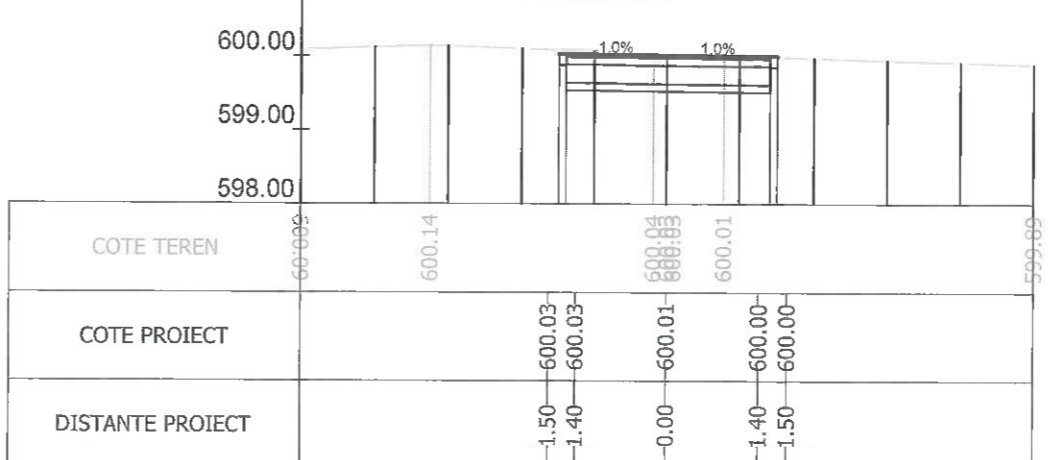

Sectiunea 110 - Km 1+200
Ax-Traseul 1

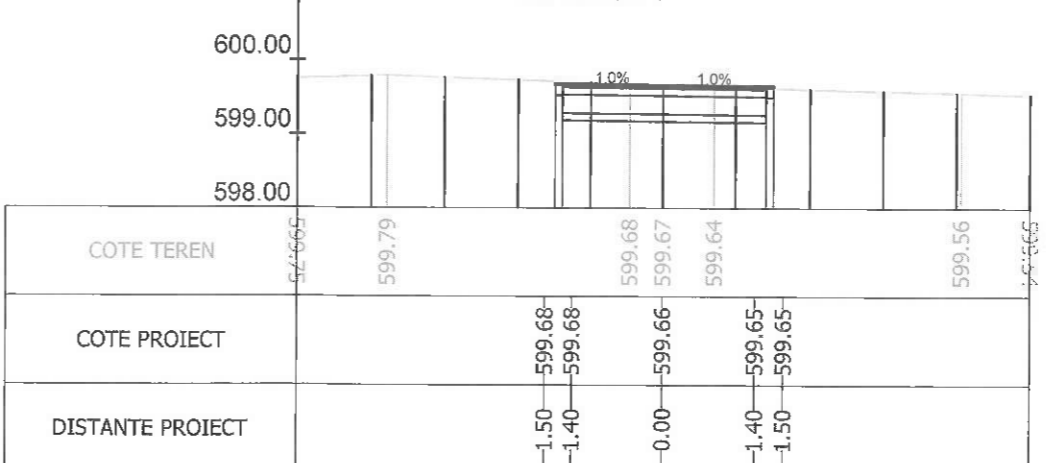

Sectiunea 112 - Km 1+225
Ax-Traseul 1



Index	Data	Observatii	Rev. 5
A			
		Beneficiar:	MUNICIPIUL BRASOV Bulevardul Eroilor 8, Brasov 500007
		Titlu proiect:	INFRASTRUCTURA INTEGRATA PENTRU CICLISM SI TRAFIC PIETONAL CU FACILITATI COMPLEMENTARE - TRASEUL 1
		Titlu plansa:	PROFILURI TRANSVERSALE TIP
Sef Proiect	Ing. A. Buta	Scara	1:100
Proiectat	Ing. A. Buta	Data	07/2023
Desenat	Ing. S. Patroi		
Verificat			
			Nr. proiect 73 / 2020
			Faza P.T.
			Nr. plansa PTC 08

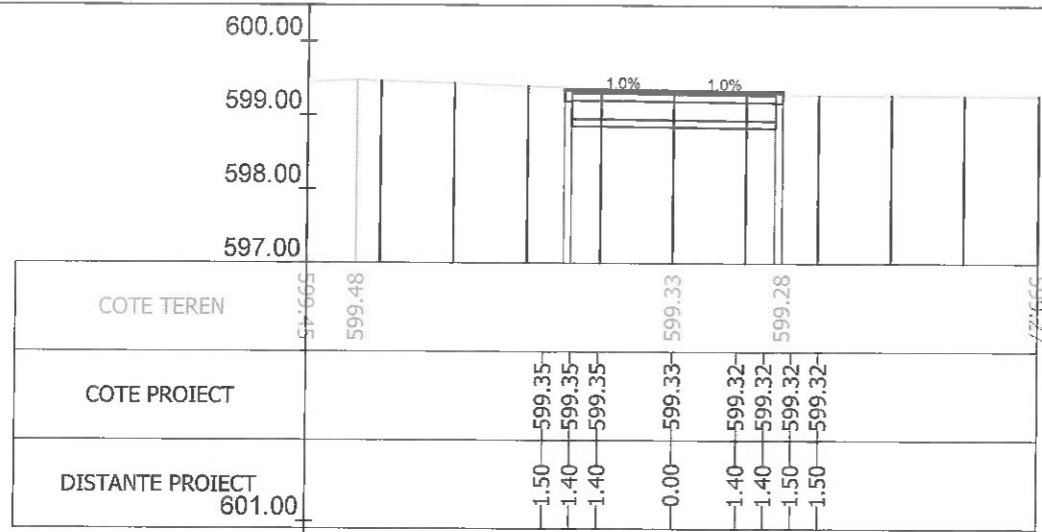

Sectiunea 113 - Km 1+248.364
Ax-Traseul 1

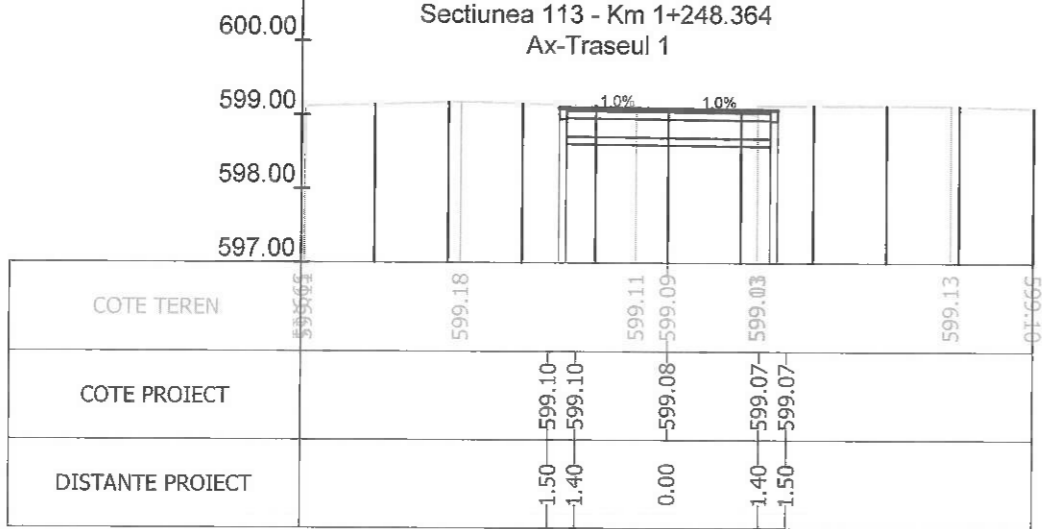

Sectiunea 114 - Km 1+250
Ax-Traseul 1

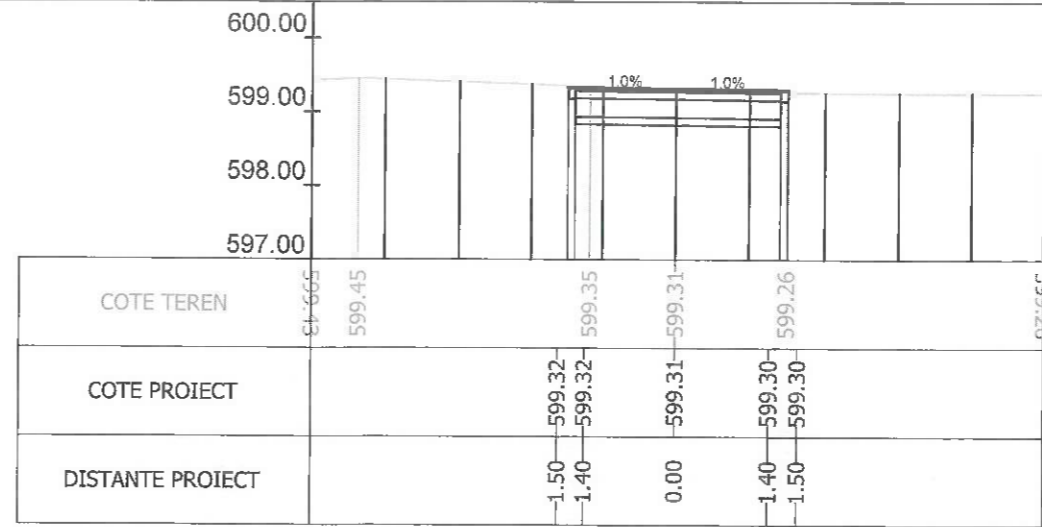

Sectiunea 116 - Km 1+300
Ax-Traseul 1

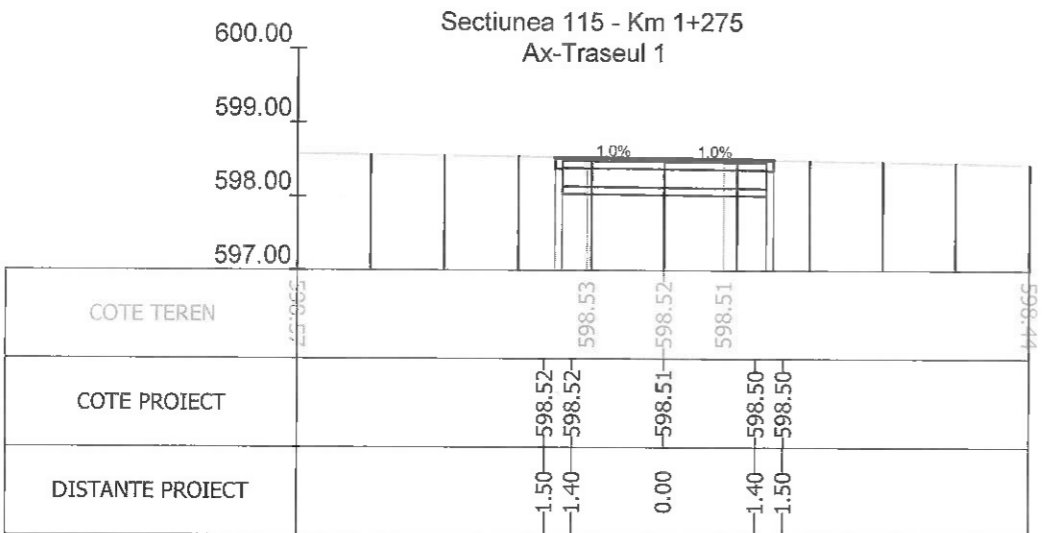

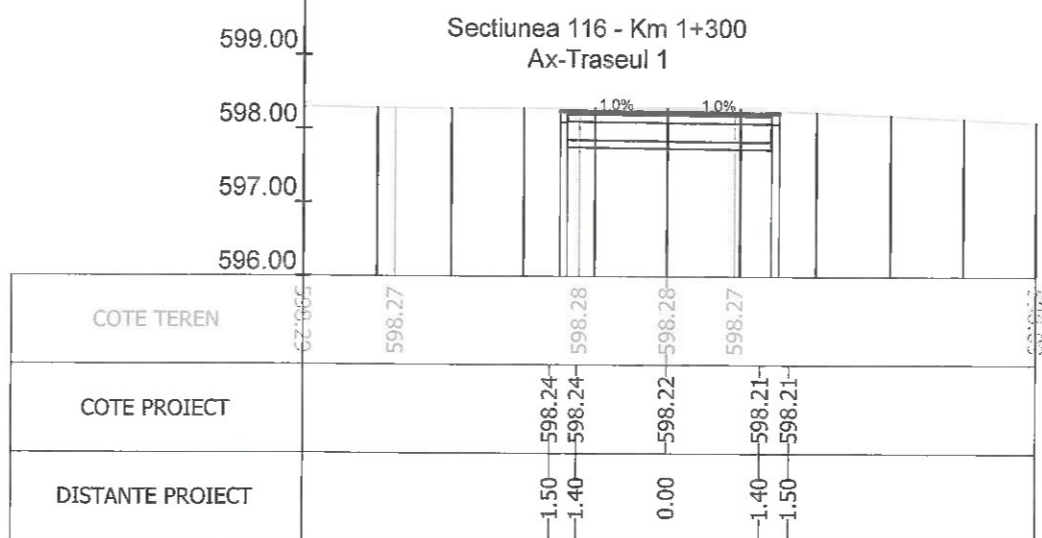

Sectiunea 117 - Km 1+325
Ax-Traseul 1

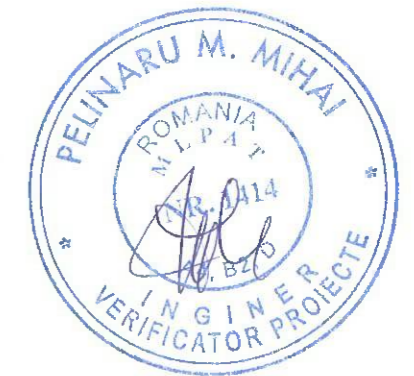

Sectiunea 118 - Km 1+350
Ax-Traseul 1



Index	Data	Observatii	Rev. 5
A			
		Beneficiar:	MUNICIPIUL BRASOV Bulevardul Eroilor 8, Brasov 500007
		Nr. proiect	73 / 2020
Sediul: Pinerodanului nr. 17 BUCURESTI, B. ETIHA 4, VOLUNTARI IUDICI, TEL: 140 37 454 0000, EMAIL: OFFICE@HENTZA.RO Sef Proiect: Ing. A. Buta Proiectat: Ing. A. Buta Desenat: Ing. S. Patroi Verificat:		Titlu proiect:	INFRASTRUCTURA INTEGRATA PENTRU CICLISM SI TRAFIC PIETONAL CU FACILITATI COMPLEMENTARE - TRASEUL 1
		Titlu plansa:	PROFILURI TRANSVERSALE TIP
		Nr. plansa	PTC 09
		Scara	1:100
		Data	07/2023

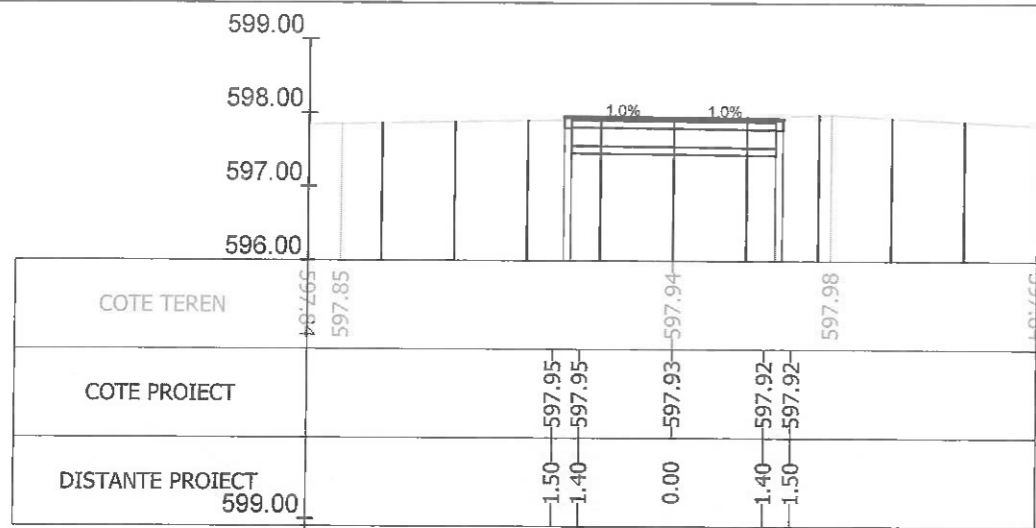

Sectiunea 119 - Km 1+375
Ax-Traseul 1

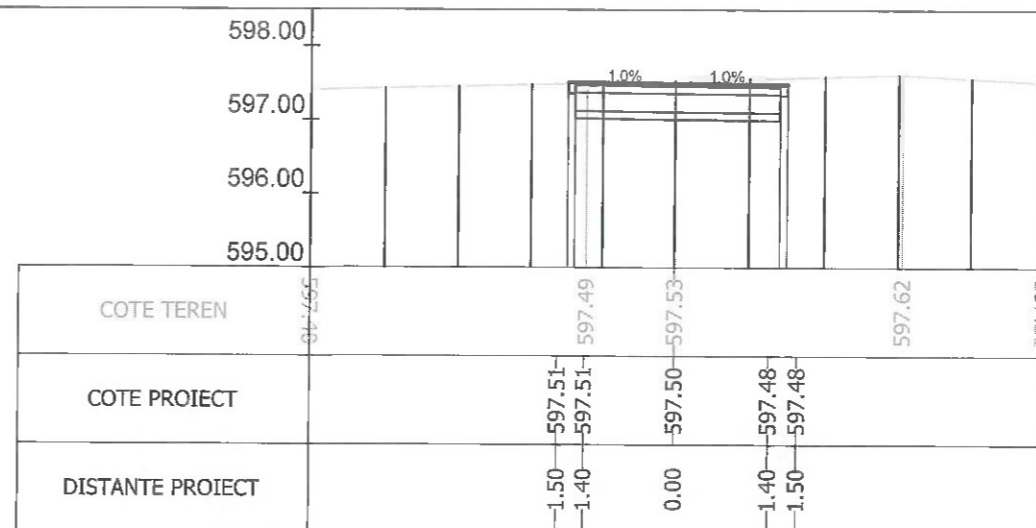

Sectiunea 120 - Km 1+400
Ax-Traseul 1

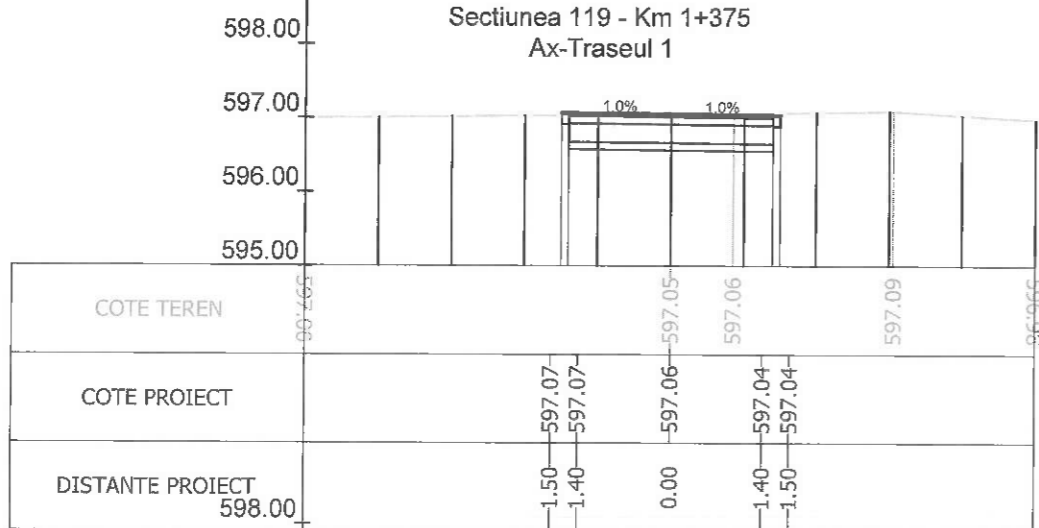

Sectiunea 121 - Km 1+425
Ax-Traseul 1

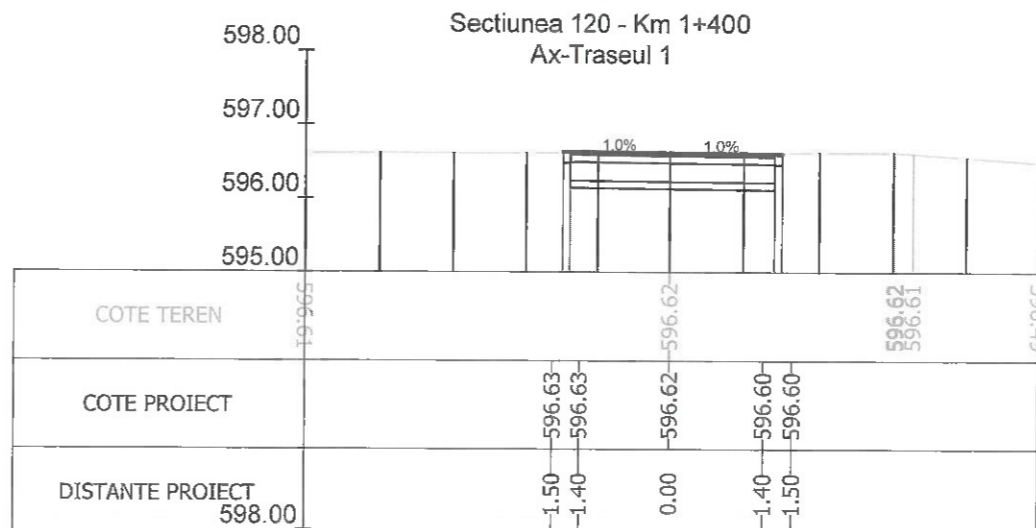

Sectiunea 122 - Km 1+450
Ax-Traseul 1

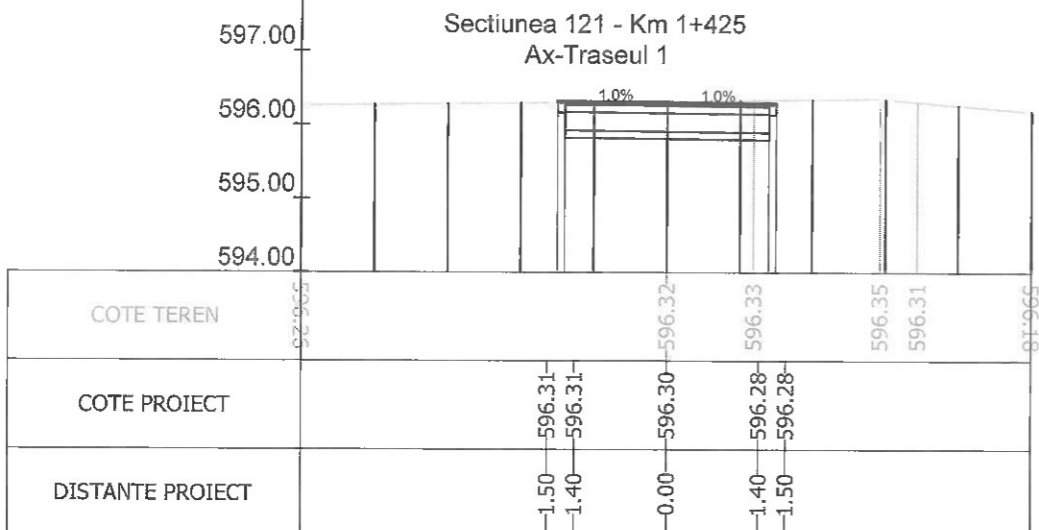

Sectiunea 123 - Km 1+475
Ax-Traseul 1

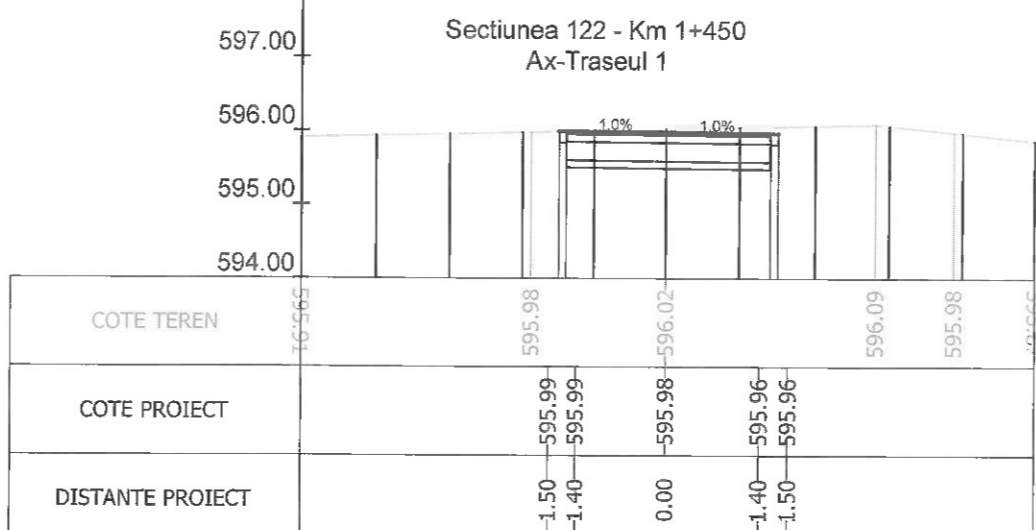

Sectiunea 124 - Km 1+500
Ax-Traseul 1



Index	Data	Observatii	Rev. 5
A			
		Beneficiar:	MUNICIPIUL BRASOV Bulevardul Eroilor 8, Brasov 500007
		Nr. proiect	73 / 2020
Sef Proiect: Ing. A. Buta Proiectat: Ing. A. Buta Desenat: Ing. S. Patroi Verificat:		Titlu proiect:	INFRASTRUCTURA INTEGRATA PENTRU CICLISM SI TRAFIC PIETONAL CU FACILITATI COMPLEMENTARE - TRASEUL 1
Scara: 1:100 Data: 07/2023		Titlu plansa:	PROFILURI TRANSVERSALE TIP
		Nr. plansa	PTC 10

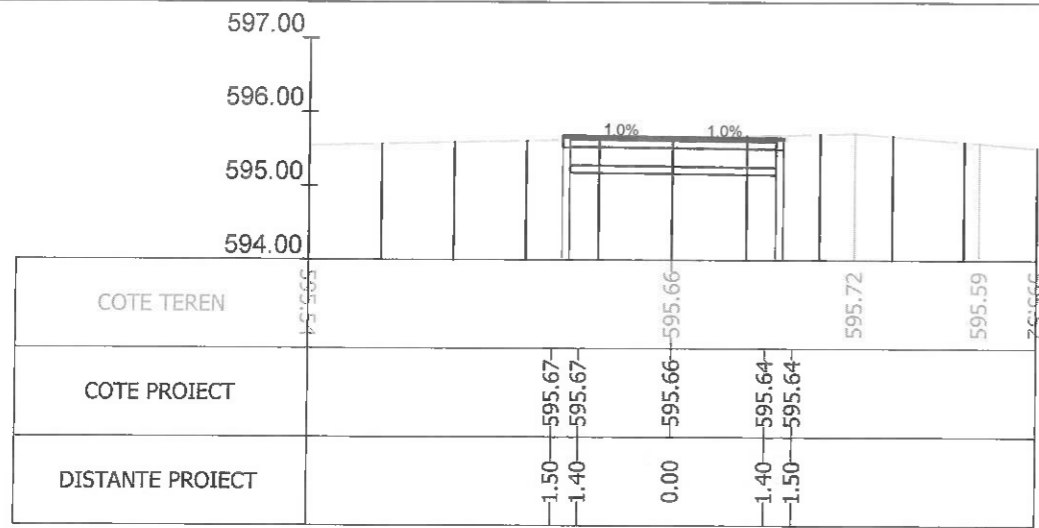

Sectiunea 125 - Km 1+525
Ax-Traseul 1

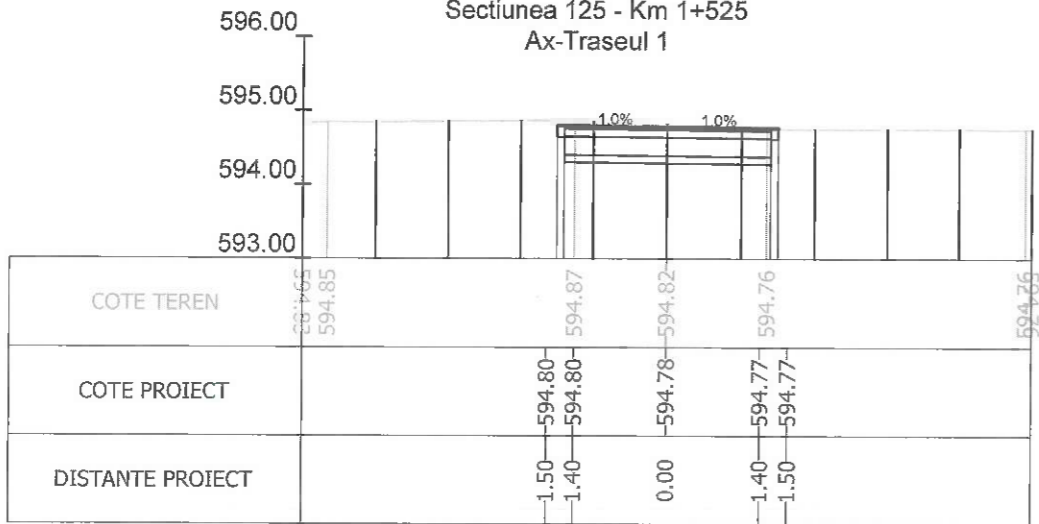

Sectiunea 126 - Km 1+550
Ax-Traseul 1

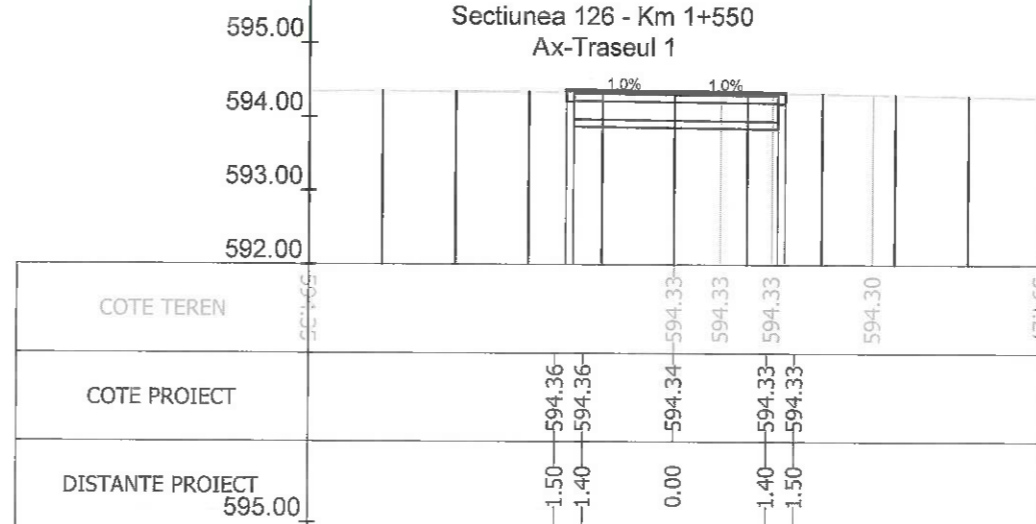

Sectiunea 128 - Km 1+600
Ax-Traseul 1

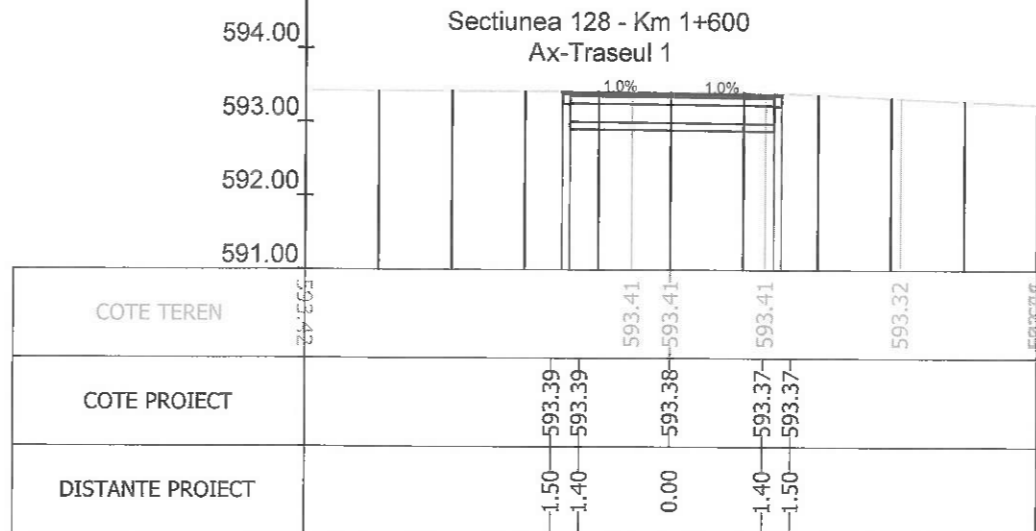

Sectiunea 129 - Km 1+625
Ax-Traseul 1

Sectiunea 130 - Km 1+650
Ax-Traseul 1

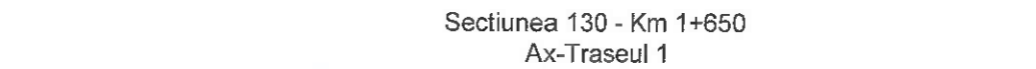

Index	Data	Observatii	Rev. 5
A			
		Beneficiar:	MUNICIPIUL BRASOV Bulevardul Eroilor 8, Brasov 500007
		Titlu proiect:	INFRASTRUCTURA INTEGRATA PENTRU CICLISM SI TRAFIC PIETONAL CU FACILITATI COMPLEMENTARE - TRASEUL 1
		Titlu plansa:	PROFILURI TRANSVERSALE TIP
Sef Proiect	Ing. A. Buta	Scara	1:100
Proiectat	Ing. A. Buta	Data	07/2023
Desenat	Ing. S. Patroi		
Verificat			
			Nr. proiect 73 / 2020
			Faza P.T.
			Nr. plansa PTC 11

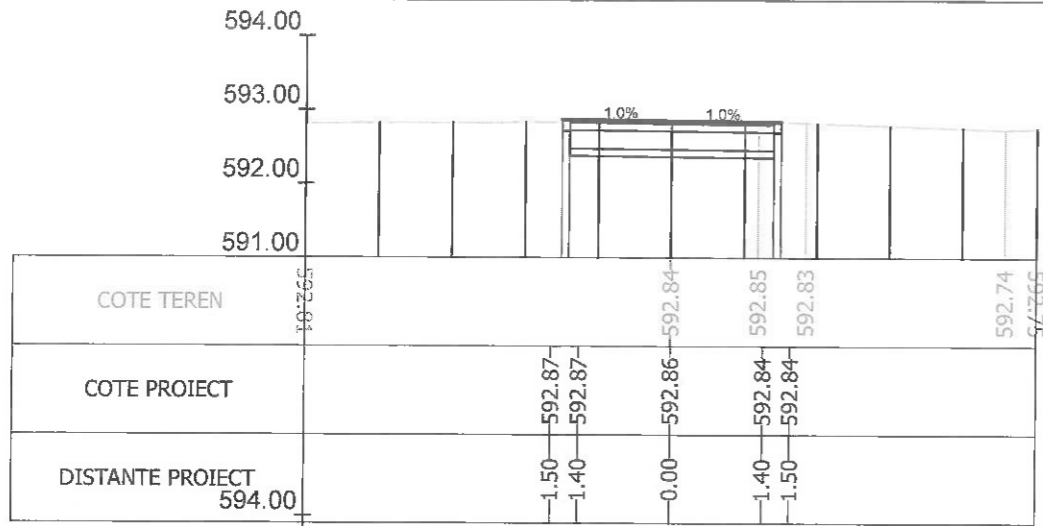

Sectiunea 131 - Km 1+675
Ax-Traseul 1

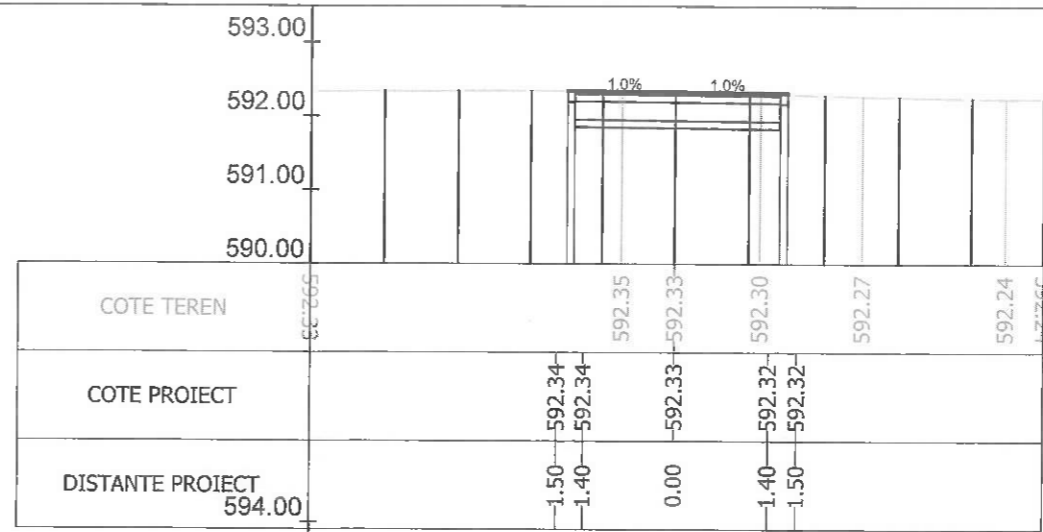

Sectiunea 132 - Km 1+700
Ax-Traseul 1

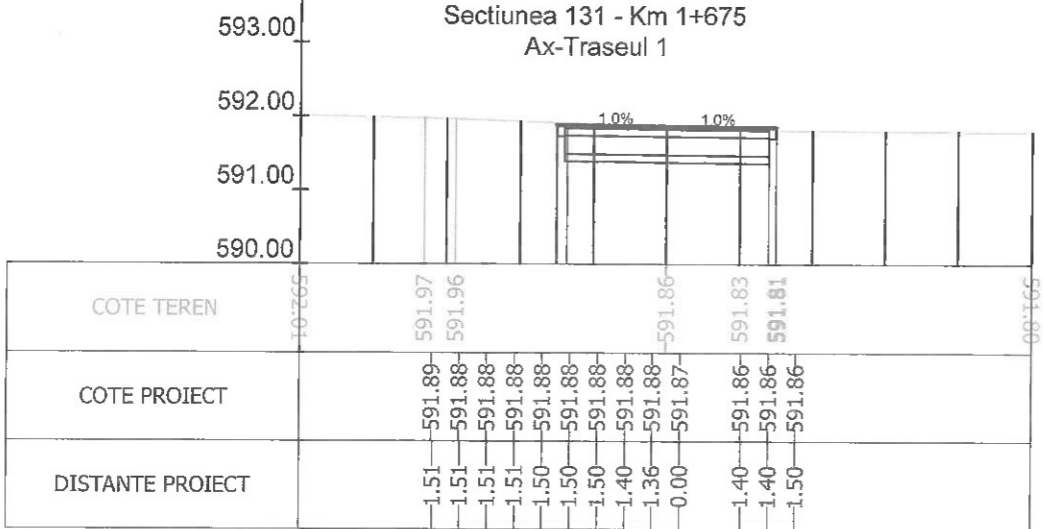

Sectiunea 133 - Km 1+724.695
Ax-Traseul 1

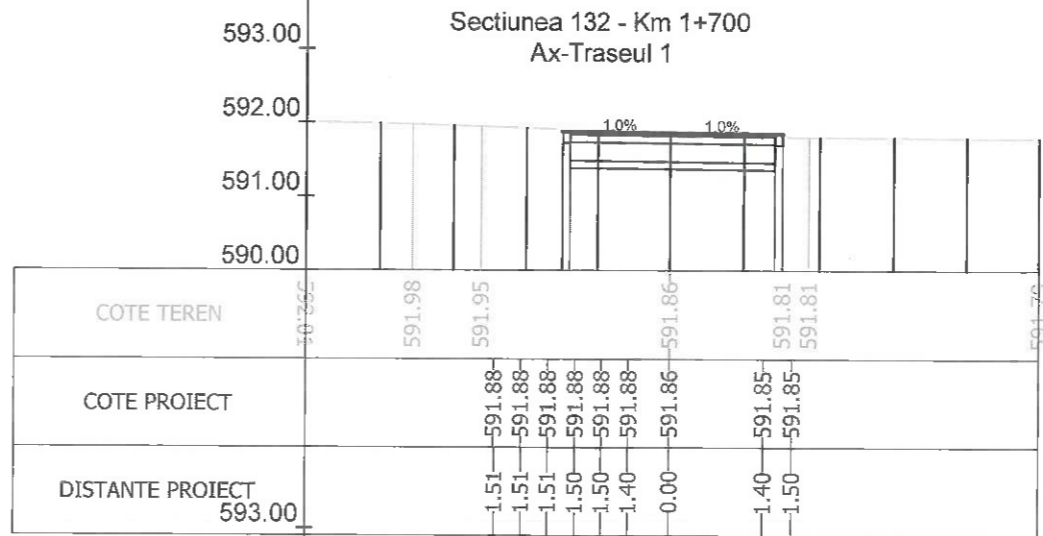

Sectiunea 134 - Km 1+725
Ax-Traseul 1

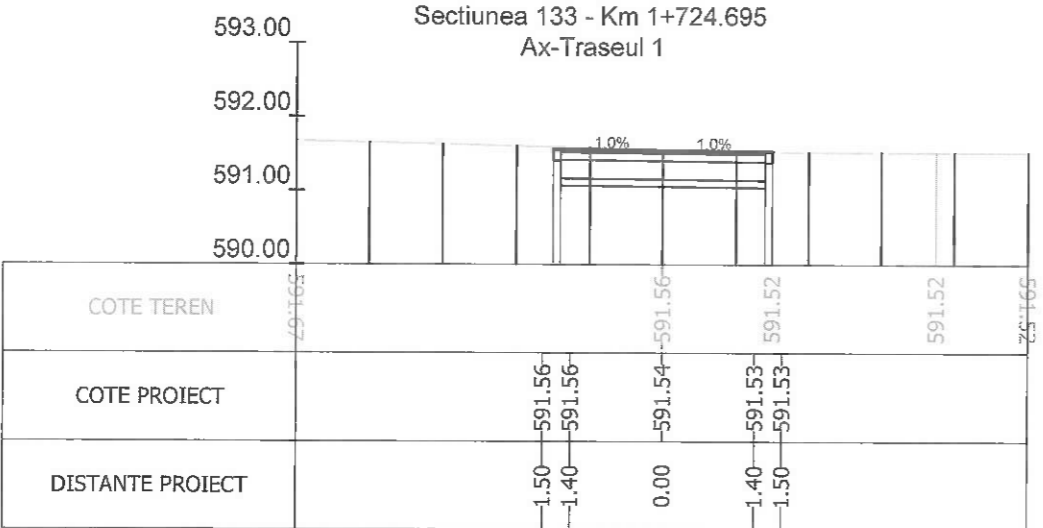

Sectiunea 135 - Km 1+750
Ax-Traseul 1

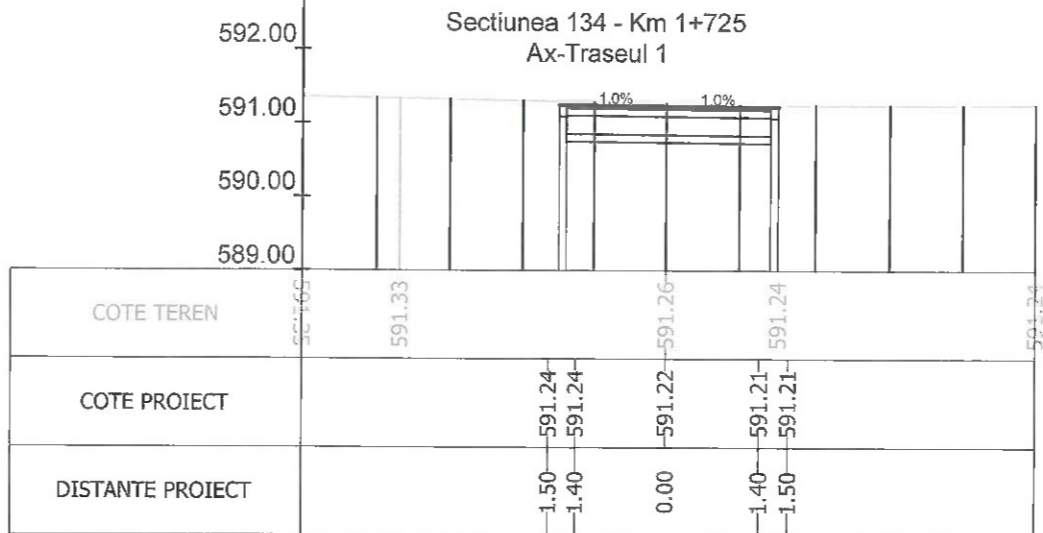

Sectiunea 136 - Km 1+775
Ax-Traseul 1



Index	Data	Observatii	Rev. 5
A			
		Beneficiar: MUNICIPIUL BRASOV Bulevardul Eroilor 8, Brasov 500007	
Sef Proiect: Ing. A. Buta		Nr. proiect: 73 / 2020	
Proiectat: Ing. A. Buta		Faza: P.T.	
Desenat: Ing. S. Patroi		Nr. plansa: PTC 12	
Verificat:		Scara: 1:100	Titlu planșă: PROFILURI TRANSVERSALE TIP
		Data: 07/2023	

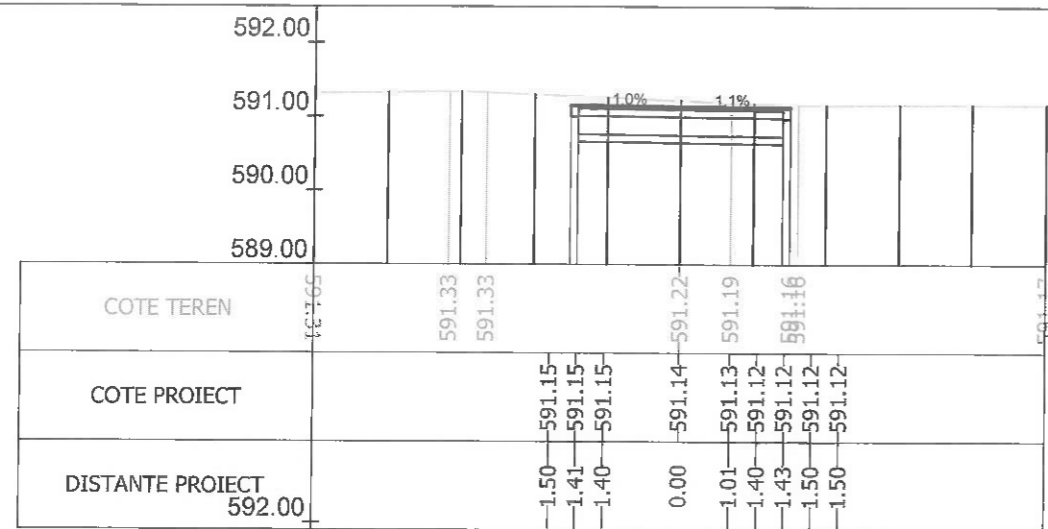

Sectiunea 137 - Km 1+781.862
Ax-Traseul 1

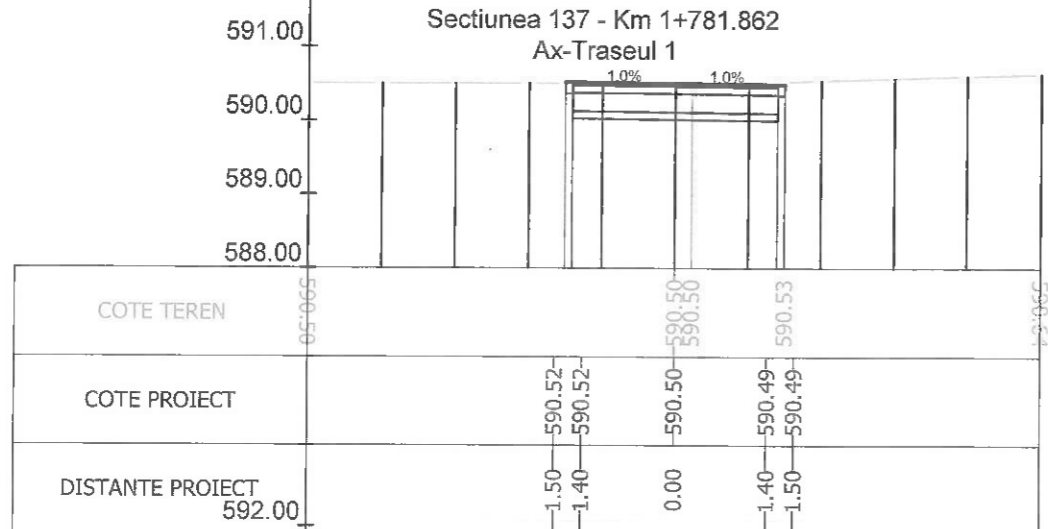

Sectiunea 138 - Km 1+800
Ax-Traseul 1

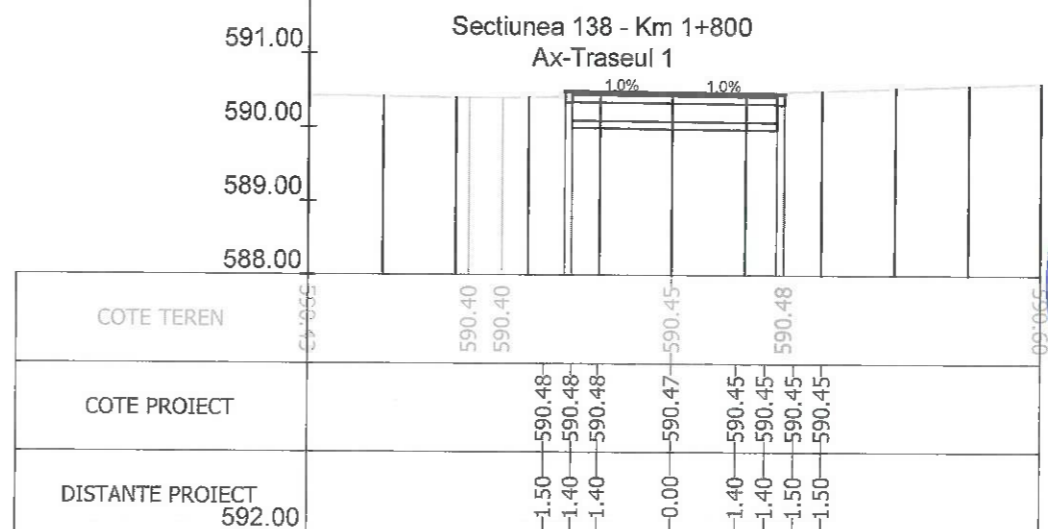

Sectiunea 139 - Km 1+825
Ax-Traseul 1

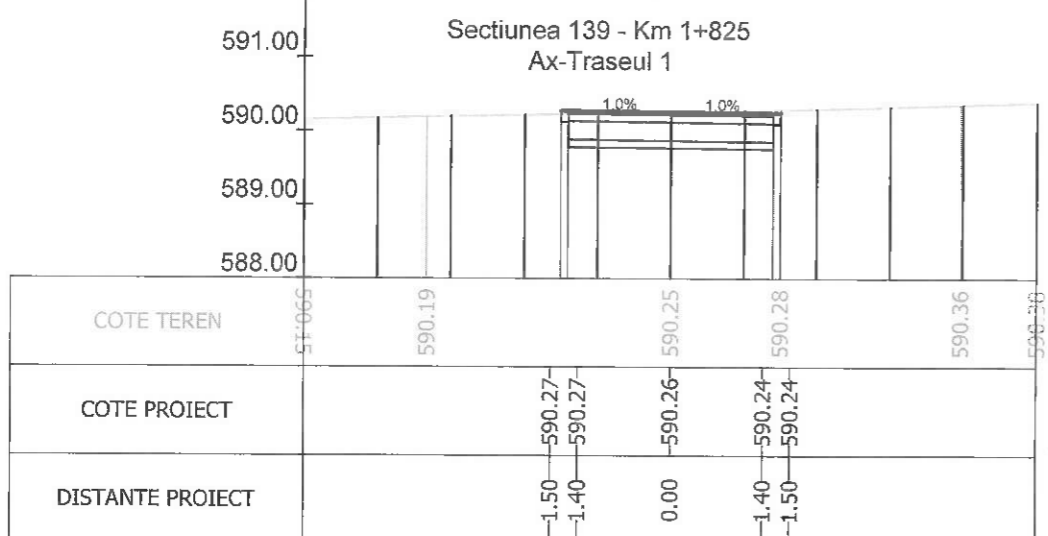

Sectiunea 140 - Km 1+828.097
Ax-Traseul 1

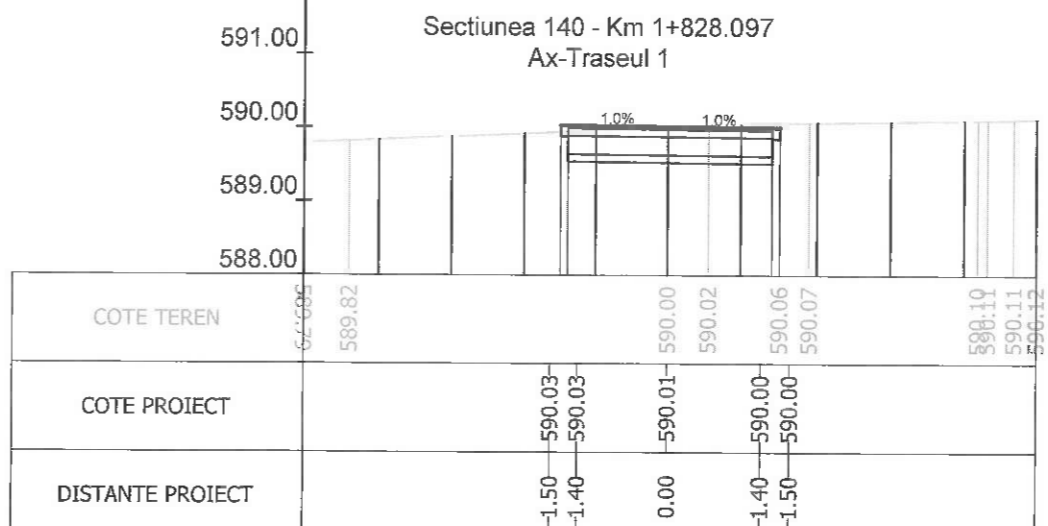

Sectiunea 141 - Km 1+850
Ax-Traseul 1

Sectiunea 142 - Km 1+875
Ax-Traseul 1



Index	Data	Observatii	Rev. 5
A			
		Beneficiar:	MUNICIPIUL BRASOV Bulevardul Eroilor 8, Brasov 500007
		Nr. proiect	73 / 2020
		Titlu proiect:	INFRASTRUCTURA INTEGRATA PENTRU CICLISM SI TRAFIC PIETONAL CU FACILITATI COMPLEMENTARE - TRASEUL 1
		Faza	P.T.
		Titlu plansa:	PROFILURI TRANSVERSALE TIP
		Nr. plansa	PTC 13
Sef Proiect	Ing. A. Buta	Scara	1:100
Proiectat	Ing. A. Buta	Data	07/2023
Desenat	Ing. S. Patroi		
Verificat			

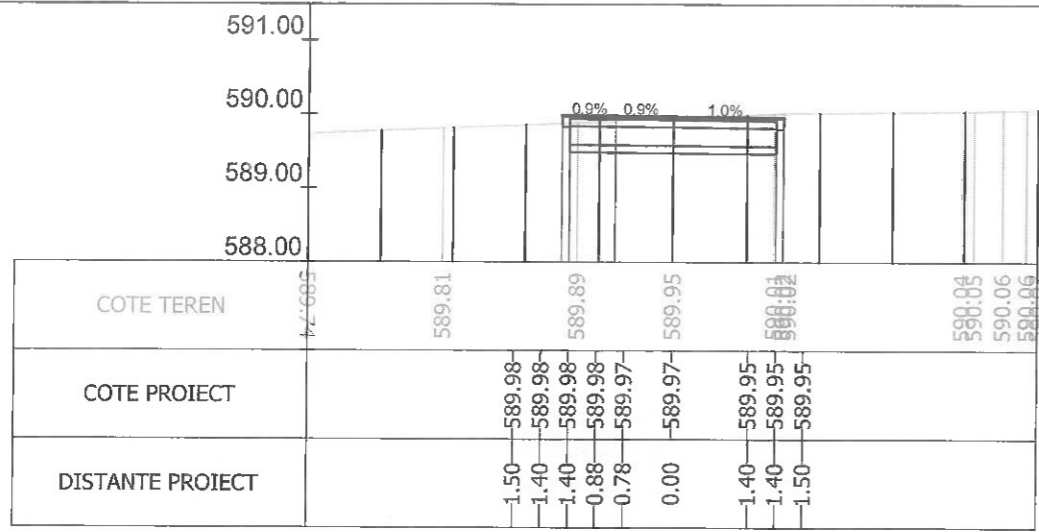

Sectiunea 143 - Km 1+879.943
Ax-Traseul 1

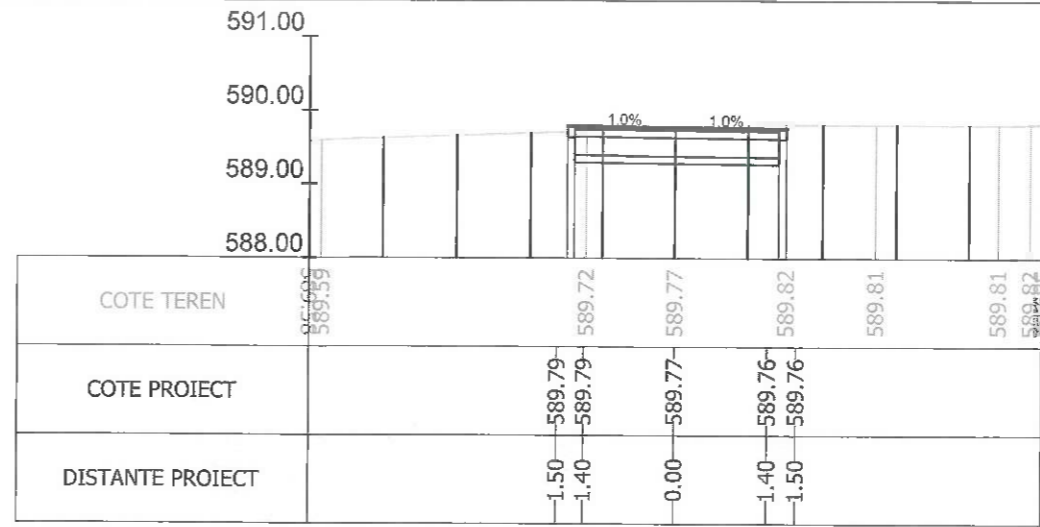

Sectiunea 144 - Km 1+900
Ax-Traseul 1

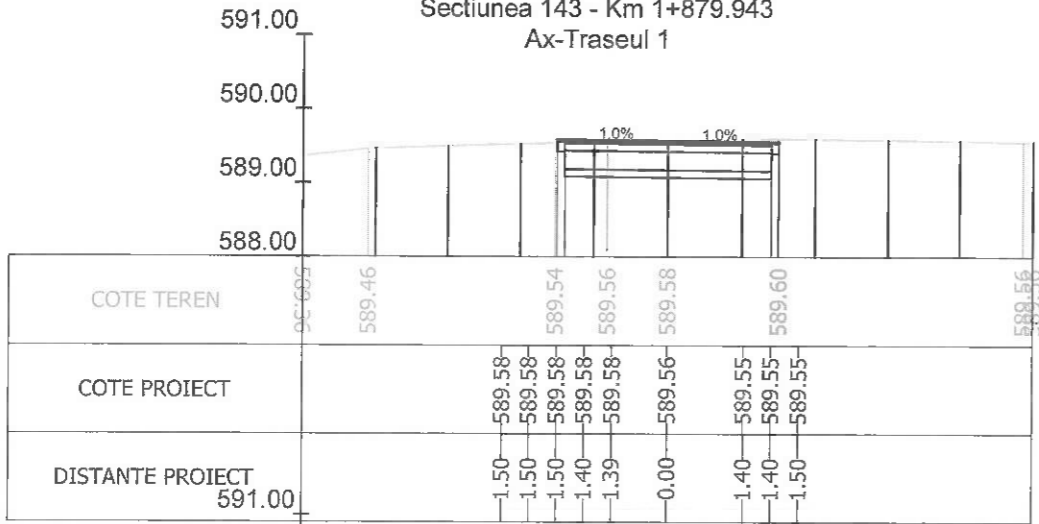

Sectiunea 145 - Km 1+921.550
Ax-Traseul 1

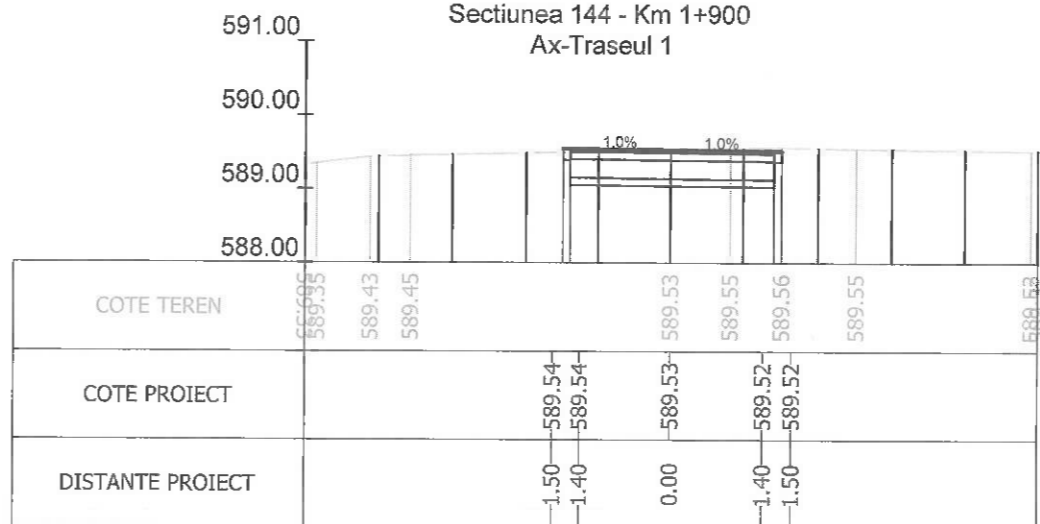

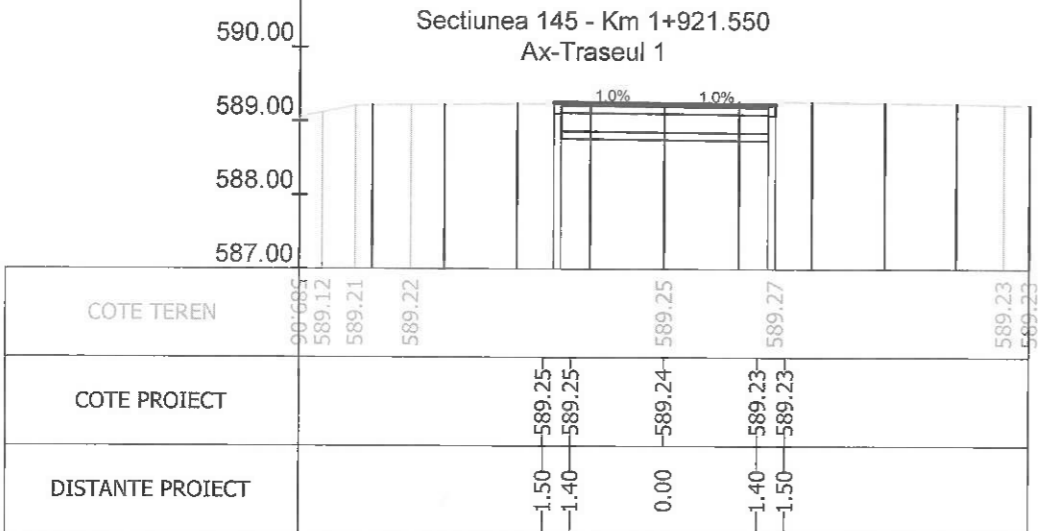

Sectiunea 146 - Km 1+925
Ax-Traseul 1

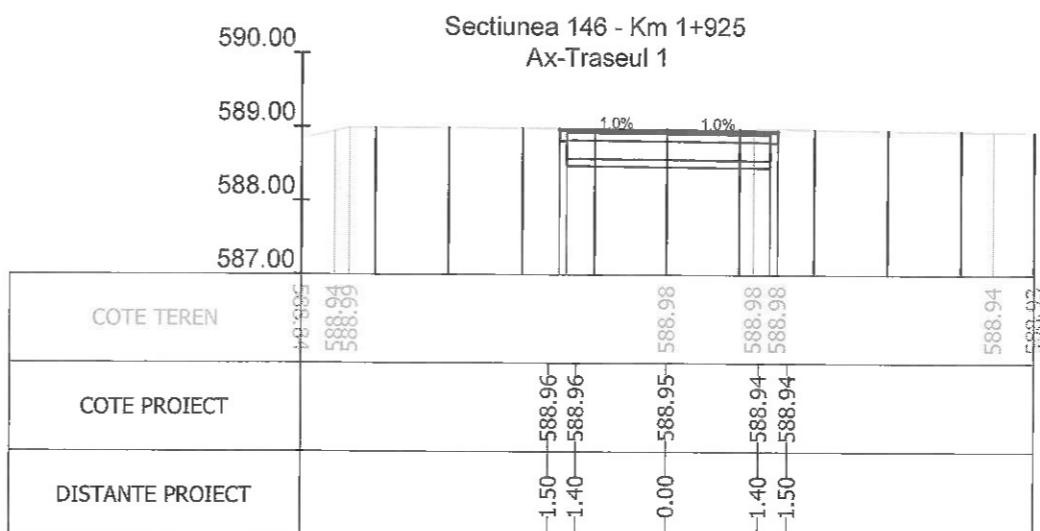

Sectiunea 147 - Km 1+950
Ax-Traseul 1



Sectiunea 148 - Km 1+975
Ax-Traseul 1

Index	Data	Observatii	Rev. 5
A			
		Beneficiar:	MUNICIPIUL BRASOV Bulevardul Eroilor 8, Brasov 500007
		Nr. proiect	73 / 2020
Sef Proiect Proiectat Desenat Verificat		Ing. A. Buta Ing. A. Buta Ing. S. Patroi	Faza P.T. Nr. plansa PTC 14
Scara 1:100		Data 07/2023	Titlu proiect: INFRASTRUCTURA INTEGRATA PENTRU CICLISM SI TRAFIC PIETONAL CU FACILITATI COMPLEMENTARE - TRASEUL 1
Titlu plansa: PROFILURI TRANSVERSALE TIP			

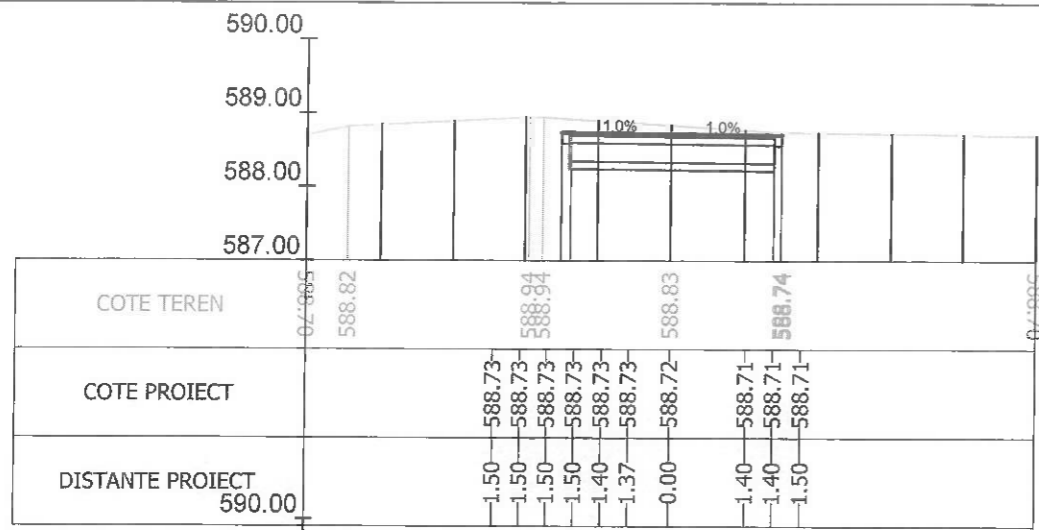

Sectiunea 149 - Km 1+994.793
Ax-Traseul 1

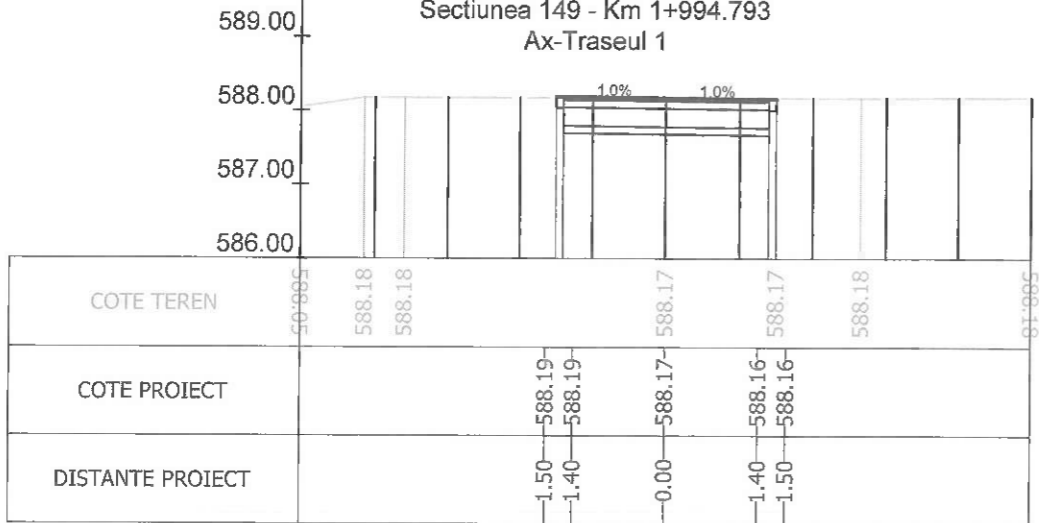

Sectiunea 151 - Km 2+025
Ax-Traseul 1

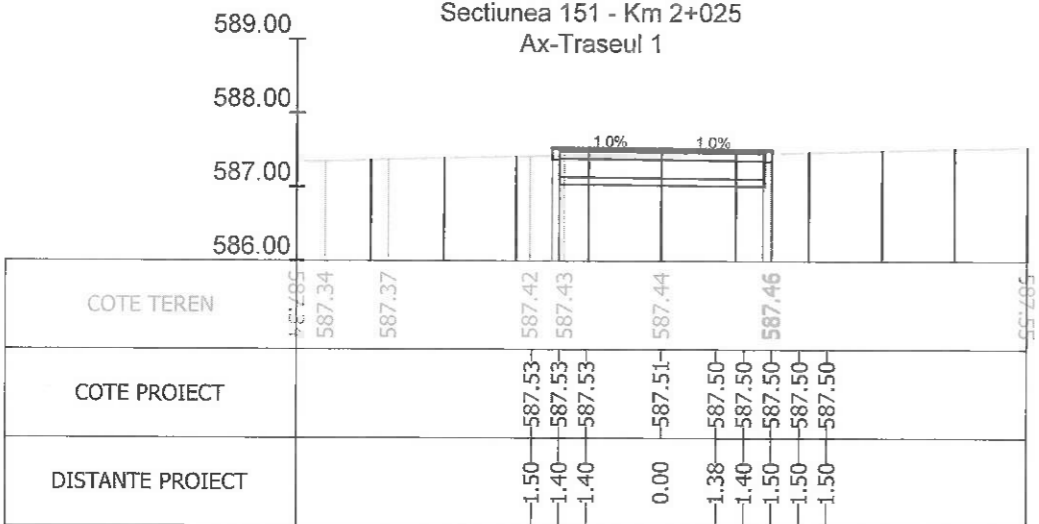

Sectiunea 153 - Km 2+062.825
Ax-Traseul 1

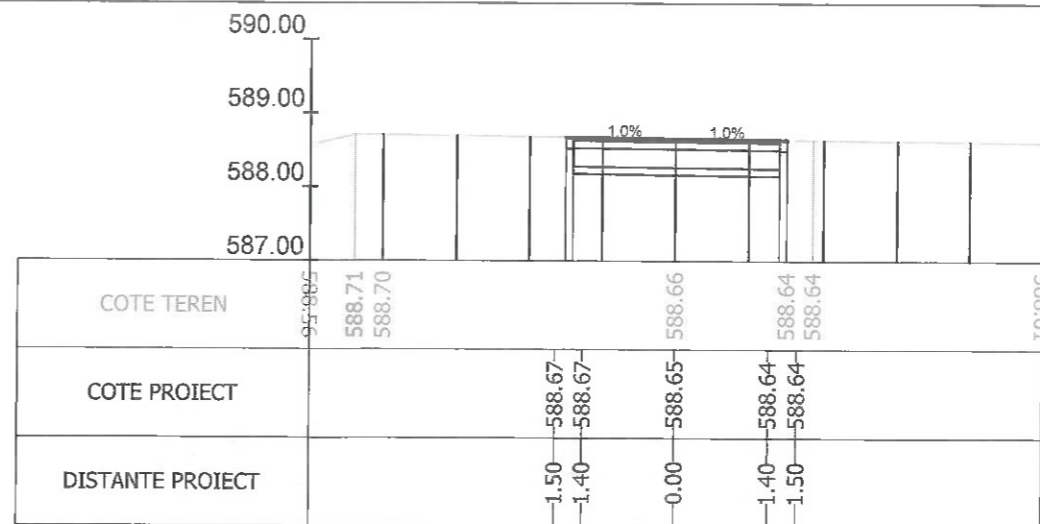

Sectiunea 150 - Km 2+000
Ax-Traseul 1

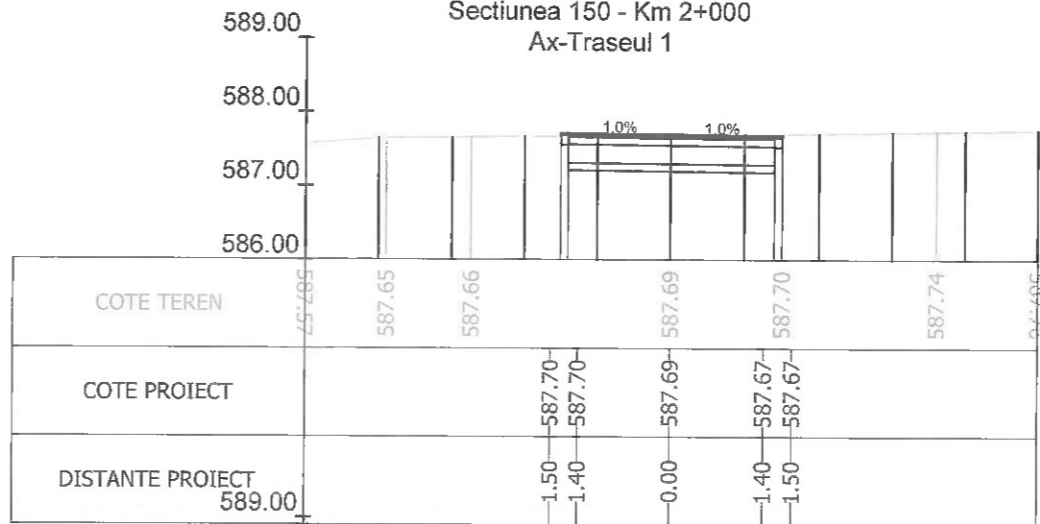

Sectiunea 152 - Km 2+050
Ax-Traseul 1

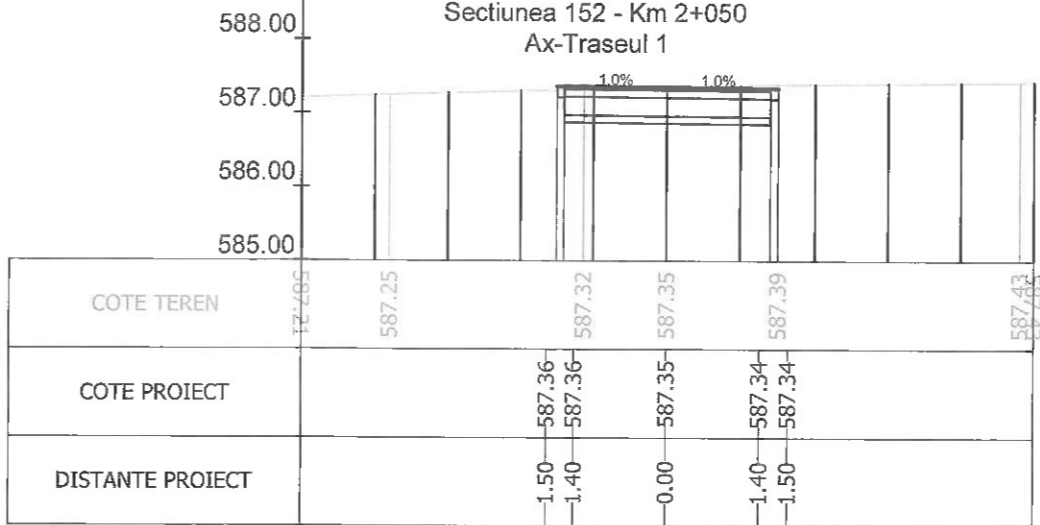

Sectiunea 154 - Km 2+075
Ax-Traseul 1

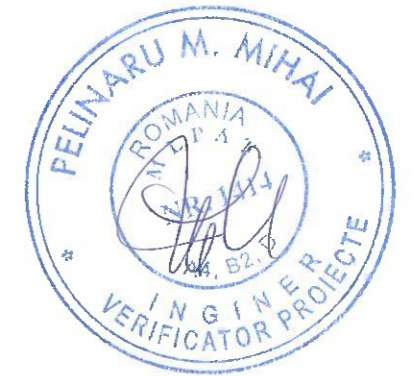

Index	Data	Observatii	Rev. 5
A			
		Beneficiar:	MUNICIPIUL BRASOV Bulevardul Eroilor 8, Brasov 500007
		Nr. proiect	73 / 2020
		Titlu proiect:	INFRASTRUCTURA INTEGRATA PENTRU CICLISM SI TRAFIC PIETONAL CU FACILITATI COMPLEMENTARE - TRASEUL 1
		Faza	P.T.
		Titlu plansa:	PROFILURI TRANSVERSALE TIP
		Nr. plansa	PTC 15
Sef Proiect	Ing. A. Buta	Scara	1:100
Proiectat	Ing. A. Buta	Data	07/2023
Desenat	Ing. S. Patroi		
Verificat			

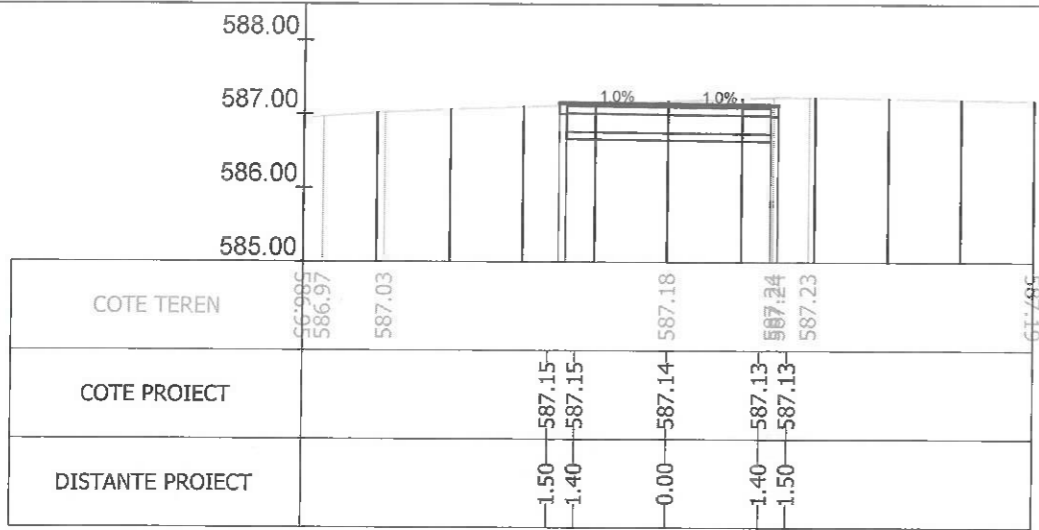

Sectiunea 155 - Km 2+100
Ax-Traseul 1

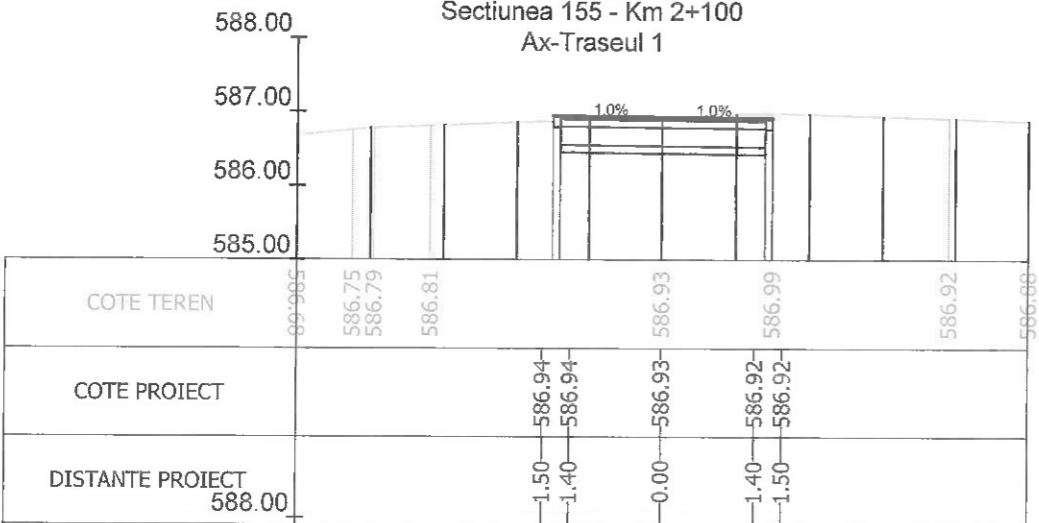

Sectiunea 156 - Km 2+113.996
Ax-Traseul 1

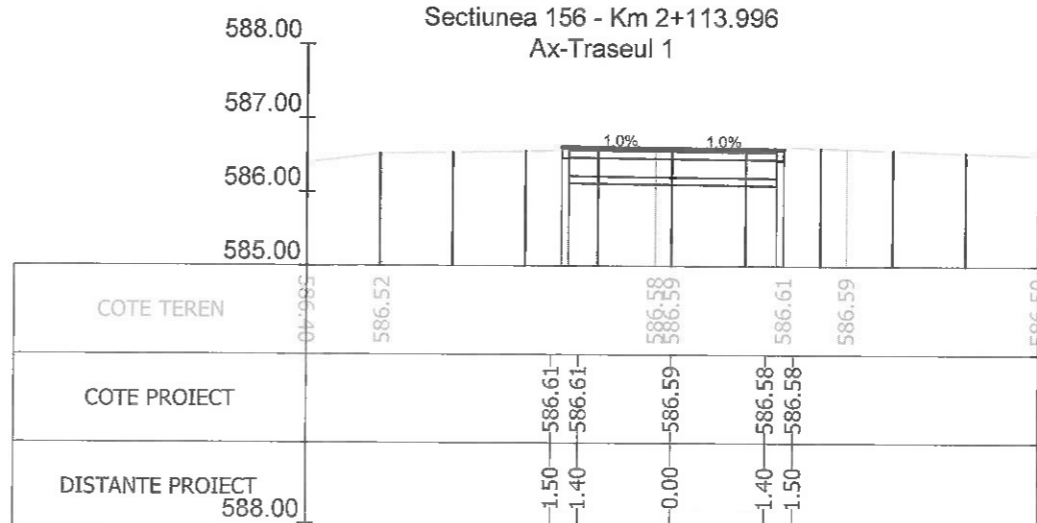

Sectiunea 159 - Km 2+164.829
Ax-Traseul 1

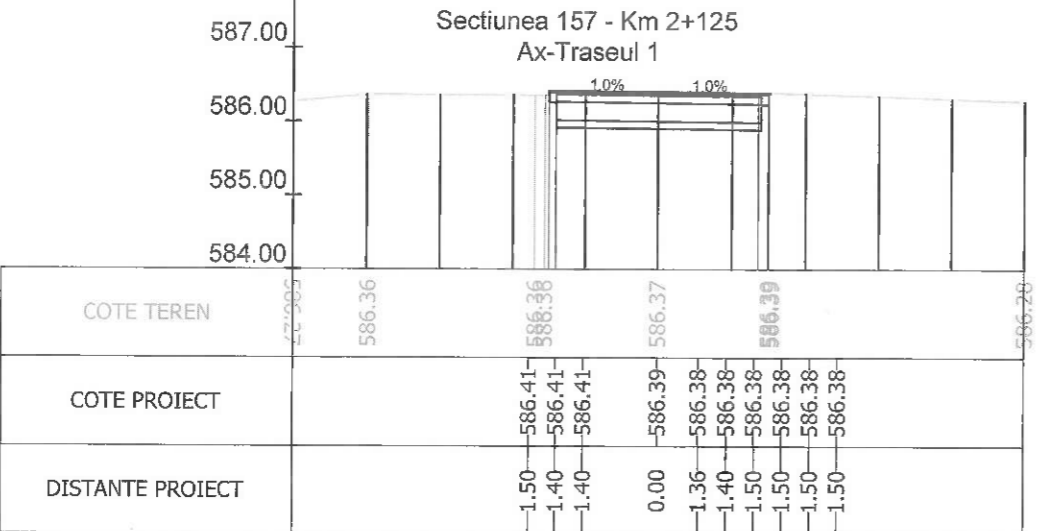

Sectiunea 160 - Km 2+175
Ax-Traseul 1

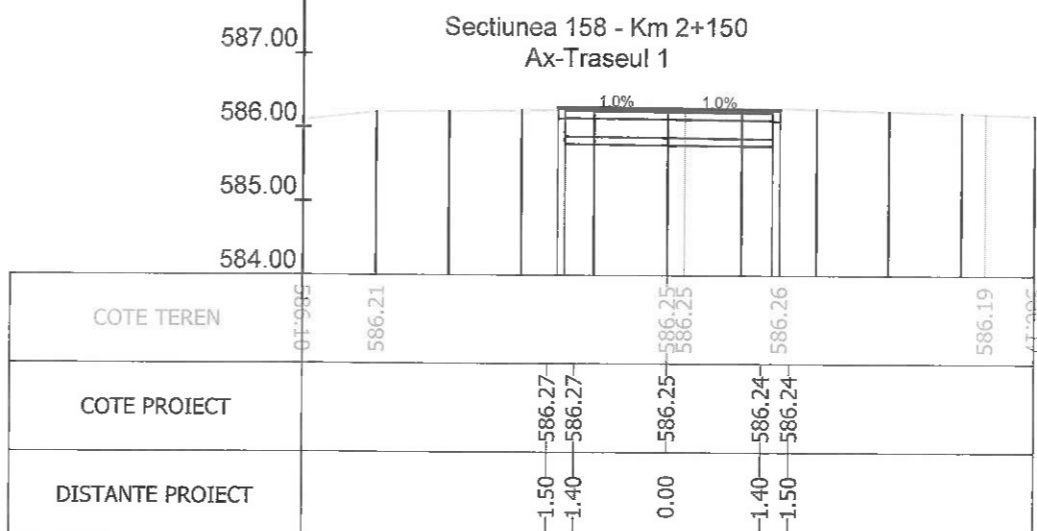

Index	Data	Observatii	Rev. 5
A			
		Beneficiar:	MUNICIPIUL BRASOV Bulevardul Eroilor 8, Brasov 500007
		Nr. proiect	73 / 2020
Sef Proiect Proiectat Desenat Verificat		Titlu proiect: Titlu plansa:	INFRASTRUCTURA INTEGRATA PENTRU CICLISM SI TRAFIC PIETONAL CU FACILITATI COMPLEMENTARE - TRASEUL 1 PROFILURI TRANSVERSALE TIP
Ing. A. Buta Ing. A. Buta Ing. S. Patroi		Scara 1:100 Data 07/2023	Faza P.T. Nr. plansa PTC 16

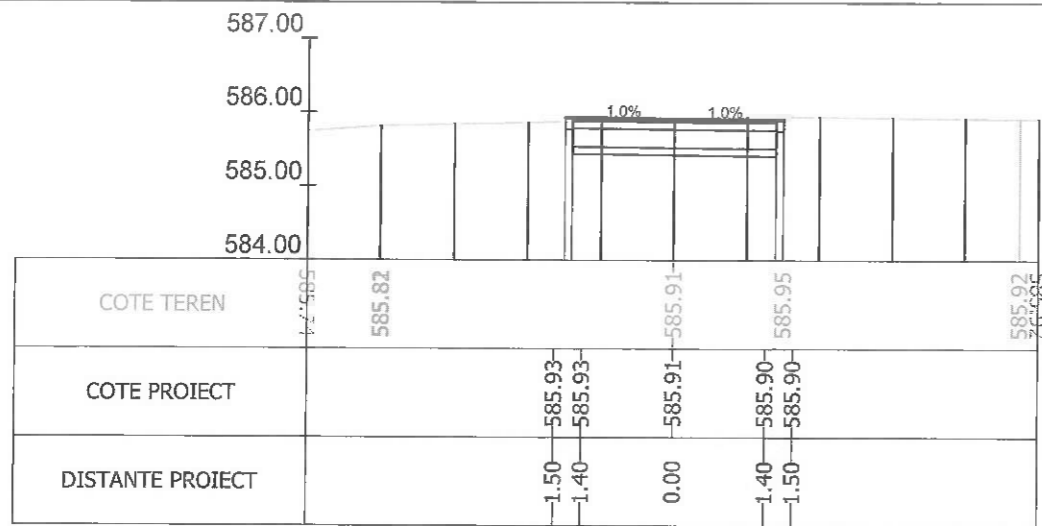

Sectiunea 161 - Km 2+200
Ax-Traseul 1

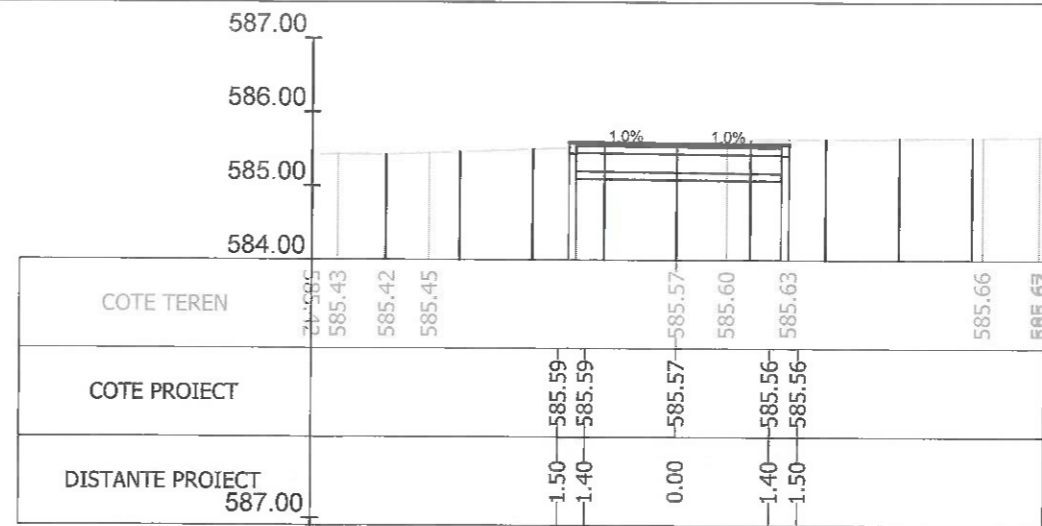

Sectiunea 162 - Km 2+225
Ax-Traseul 1

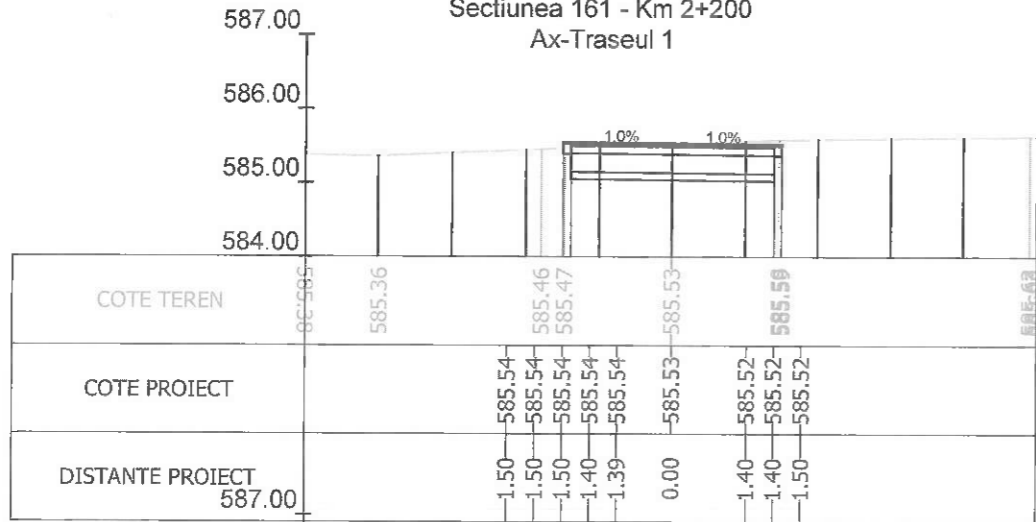

Sectiunea 163 - Km 2+228.720
Ax-Traseul 1

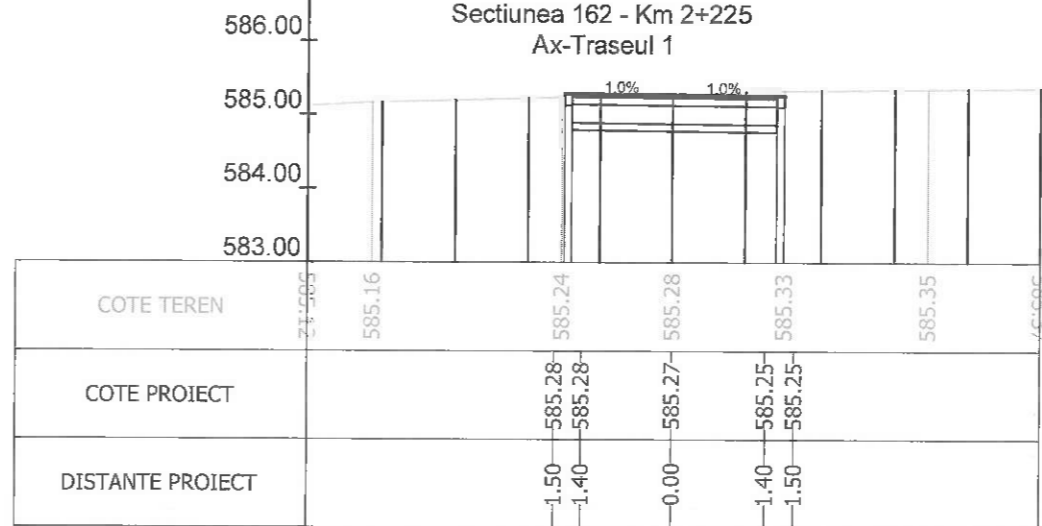

Sectiunea 164 - Km 2+250
Ax-Traseul 1

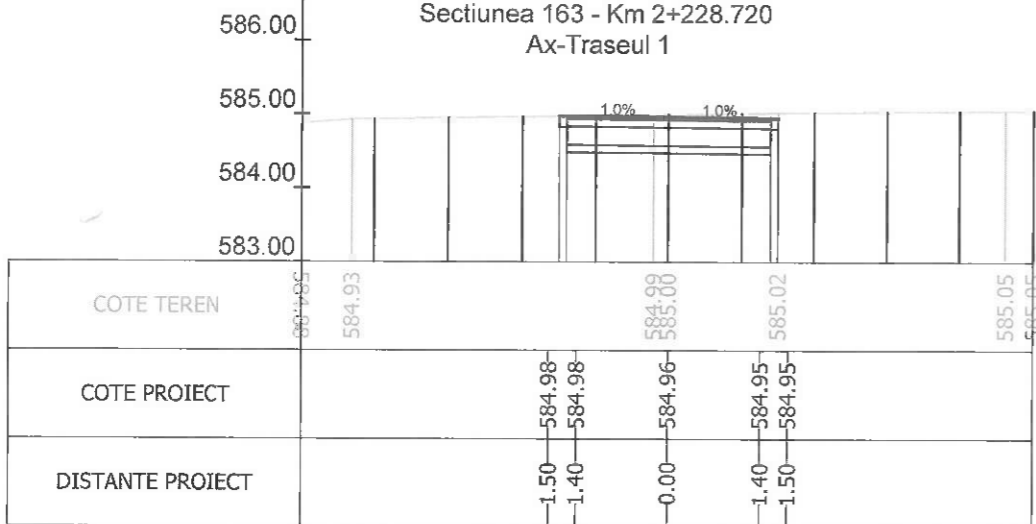

Sectiunea 165 - Km 2+275
Ax-Traseul 1

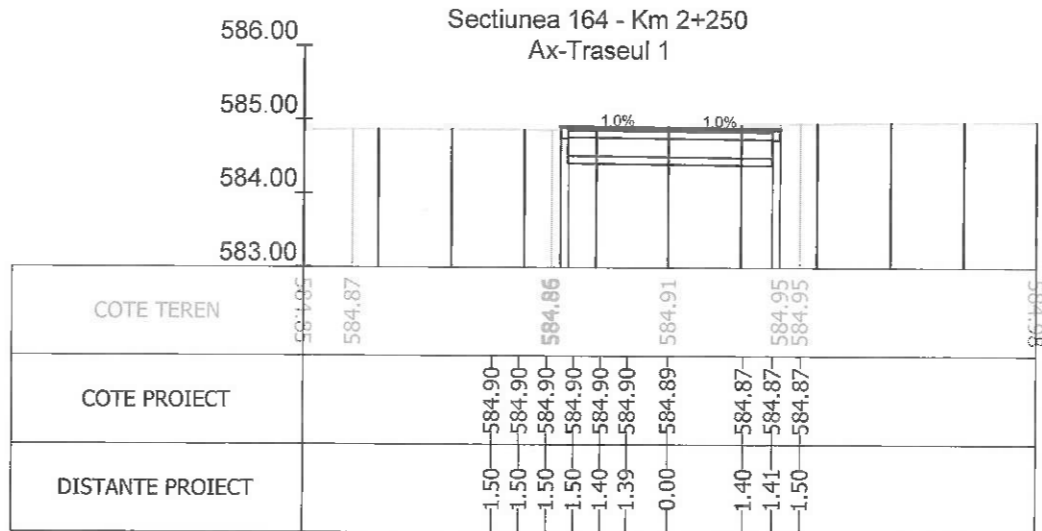

Sectiunea 166 - Km 2+281.066
Ax-Traseul 1

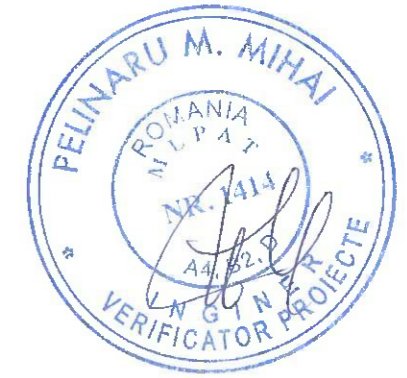

Index	Data	Observatii	Rev. 5
A			
 HENTZA BUSINESS <small>www.hentzabiz.ro</small>		Beneficiar:	MUNICIPIUL BRASOV Bulevardul Eroilor 8, Brasov 500007
Sef Proiect: Ing. A. Buta Proiectat: Ing. A. Buta Desenat: Ing. S. Patroi Verificat:		Titlu proiect:	INFRASTRUCTURA INTEGRATA PENTRU CICLISM SI TRAFIC PIETONAL CU FACILITATI COMPLEMENTARE - TRASEUL 1
Scara: 1:100 Data: 07/2023		Titlu planşa:	PROFILURI TRANSVERSALE TIP
		Nr. proiect:	73 / 2020
		Faza P.T.:	
		Nr. planşa:	PTC 17

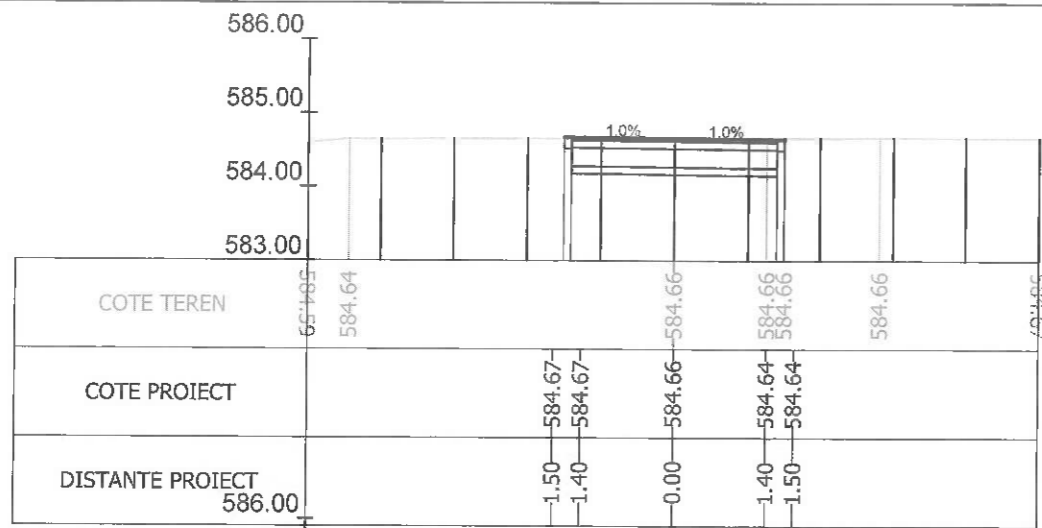

Sectiunea 167 - Km 2+300
Ax-Traseul 1

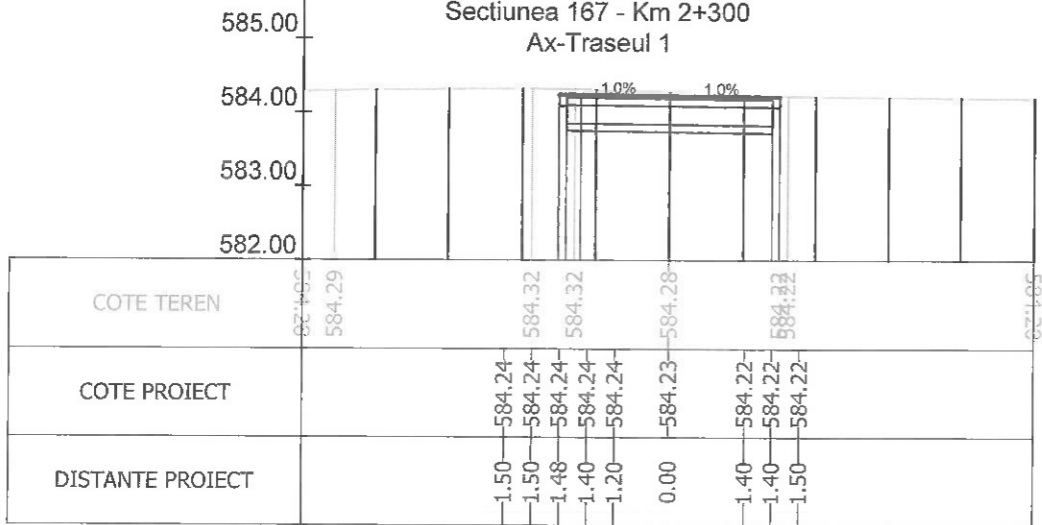

Sectiunea 168 - Km 2+325
Ax-Traseul 1

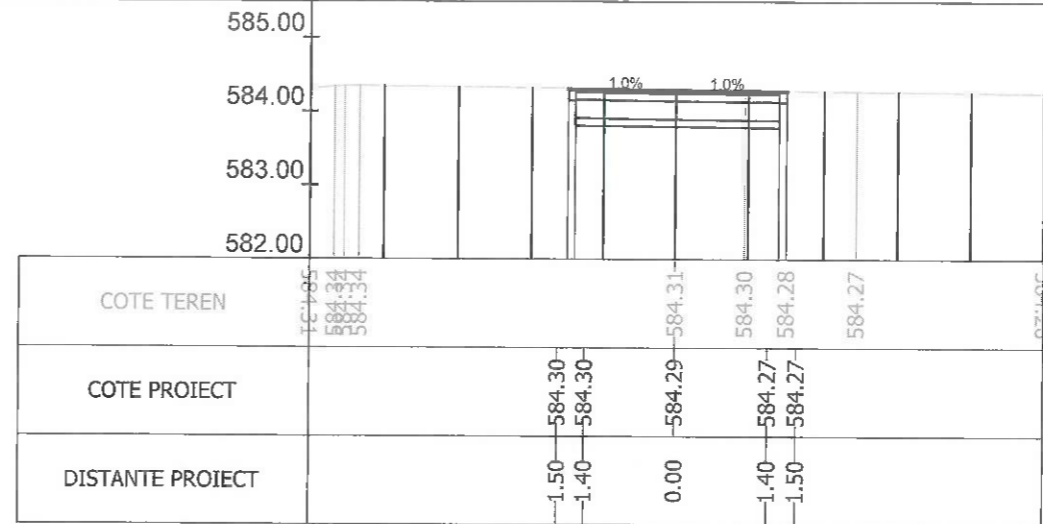

Sectiunea 170 - Km 2+350
Ax-Traseul 1

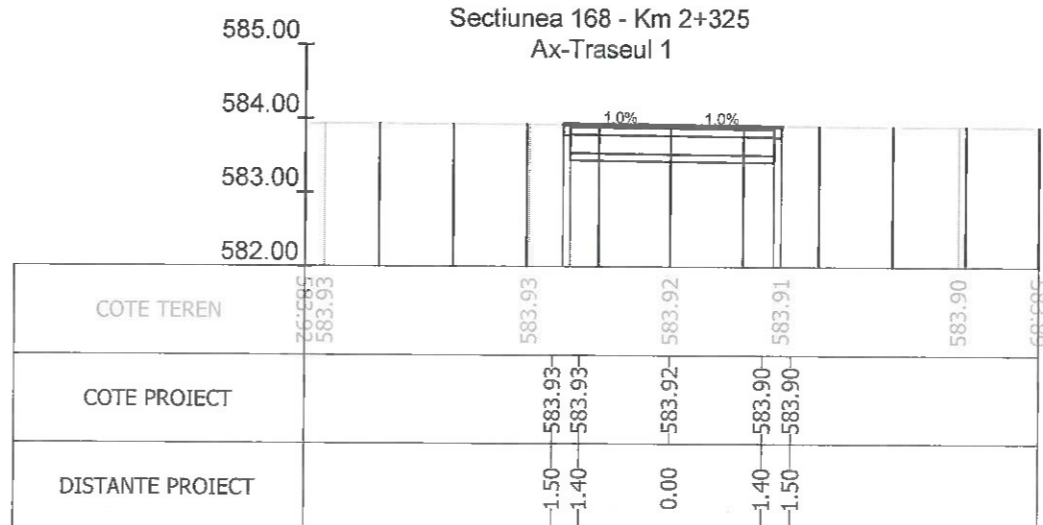

Sectiunea 171 - Km 2+366.736
Ax-Traseul 1

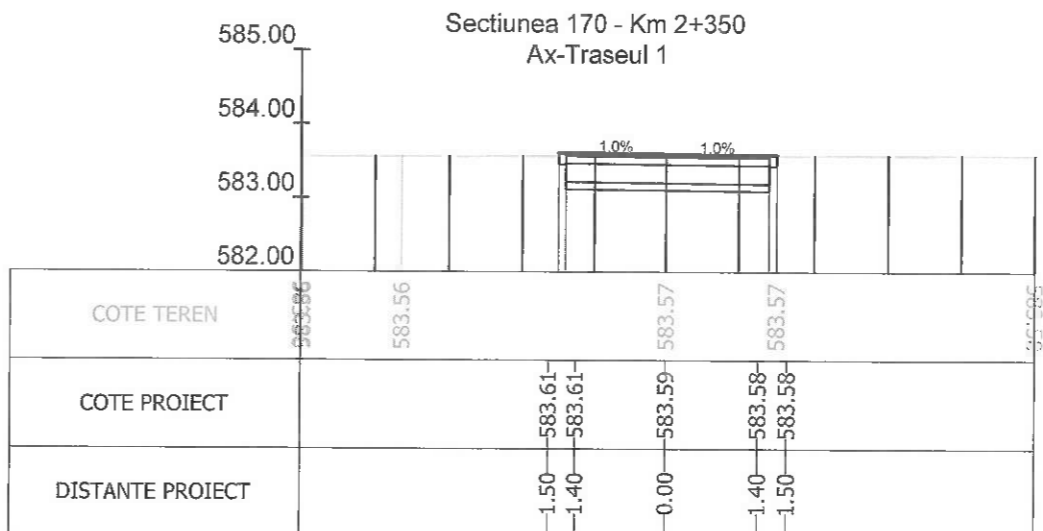

Sectiunea 172 - Km 2+375
Ax-Traseul 1



Index	Data	Observatii	Rev. 5
A			
			Beneficiar: MUNICIPIUL BRASOV Bulevardul Eroilor 8, Brasov 500007
Sef Proiect: Ing. A. Buta Proiectat: Ing. A. Buta Desenat: Ing. S. Patroi Verificat:			Nr. proiect: 73 / 2020 Faza: P.T. Nr. planșa: PTC 18
Scara: 1:100 Data: 07/2023			Titlu proiect: INFRASTRUCTURA INTEGRATA PENTRU CICLISM SI TRAFIC PIETONAL CU FACILITATI COMPLEMENTARE - TRASEUL 1 Titlu planșa: PROFILURI TRANSVERSALE TIP

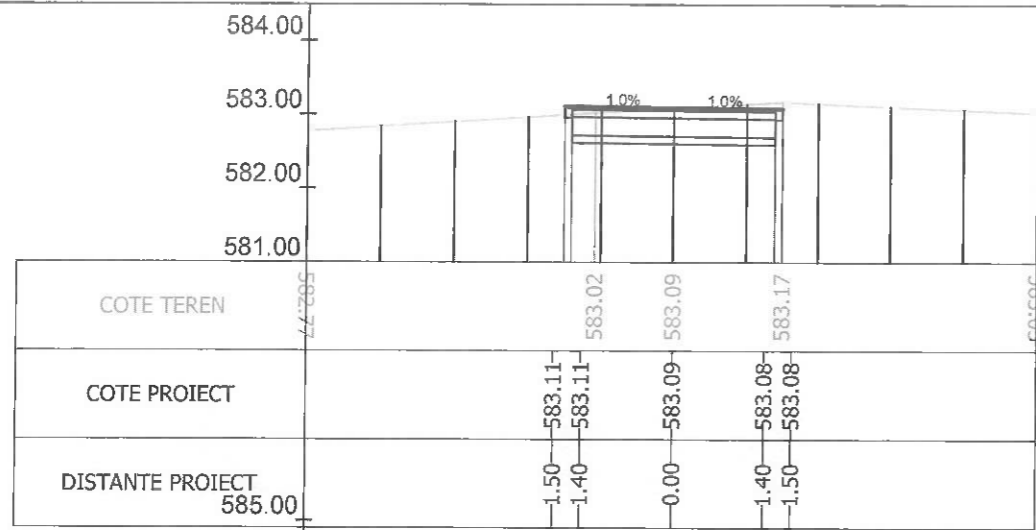

Sectiunea 179 - Km 2+450
Ax-Traseul 1

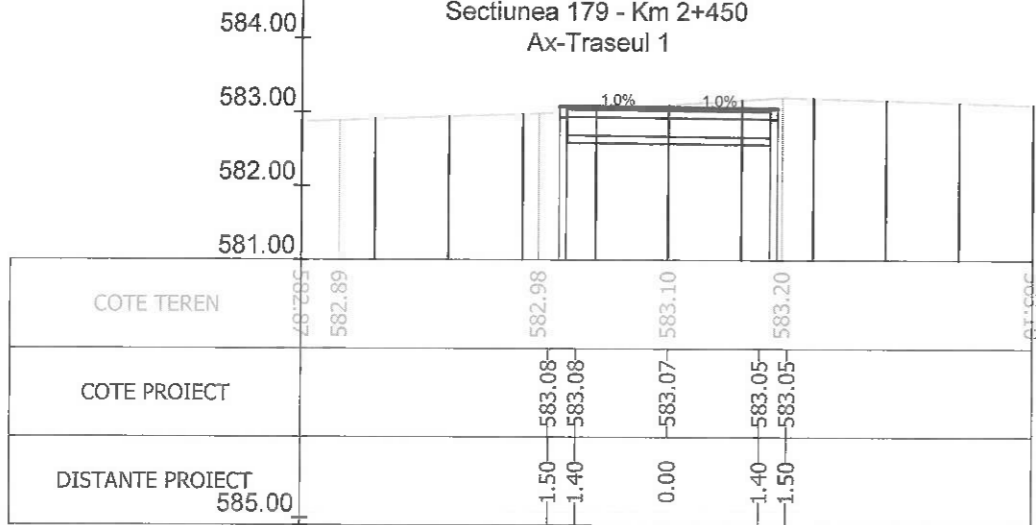

Sectiunea 181 - Km 2+472.091
Ax-Traseul 1

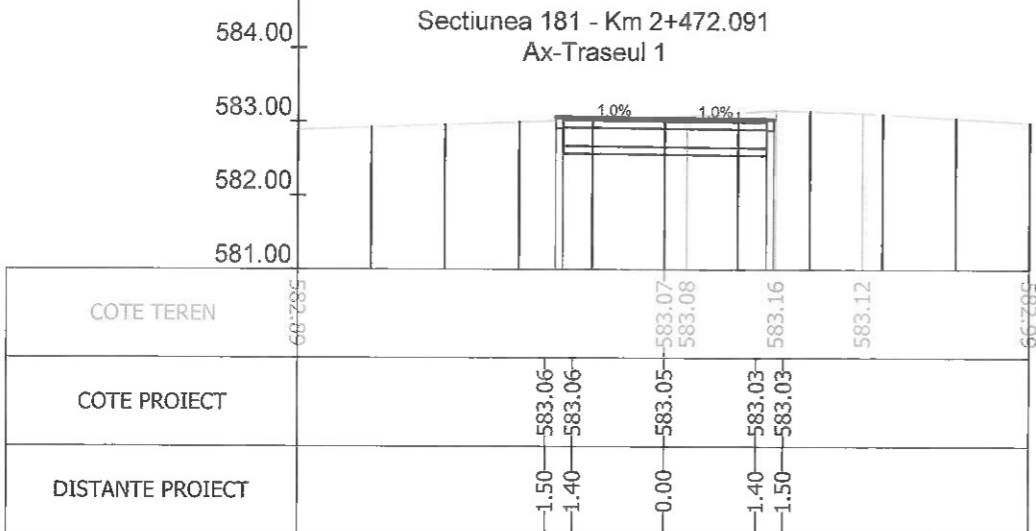

Sectiunea 183 - Km 2+475
Ax-Traseul 1

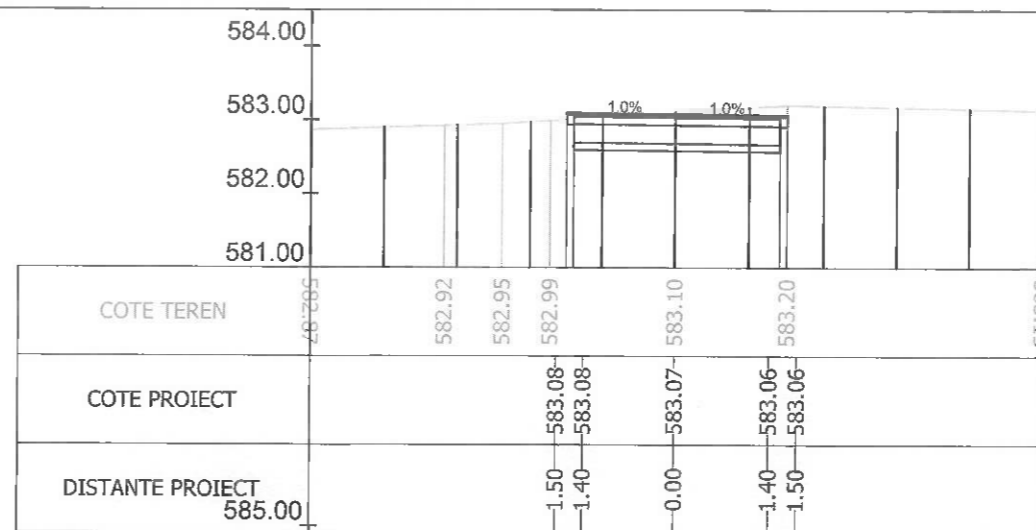

Sectiunea 180 - Km 2+470.754
Ax-Traseul 1

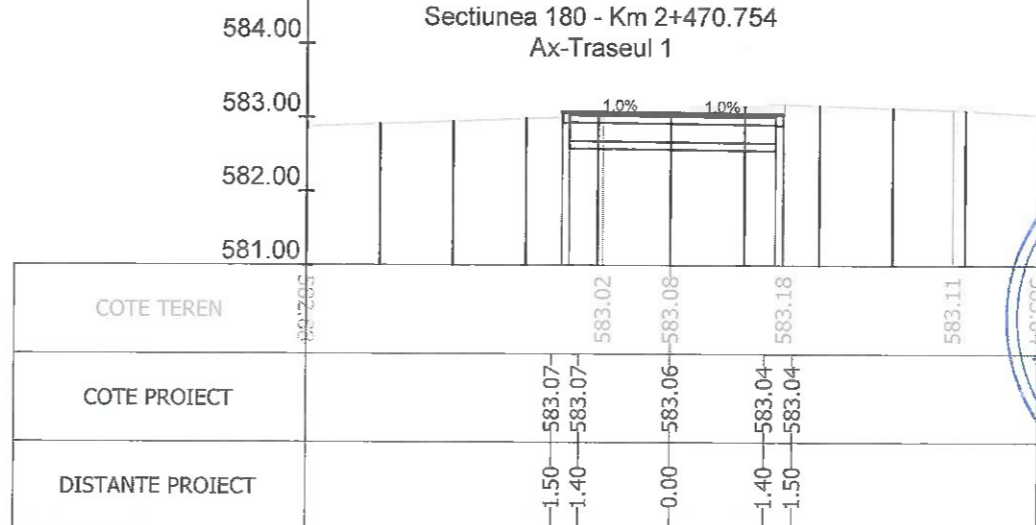

Sectiunea 182 - Km 2+473.428
Ax-Traseul 1

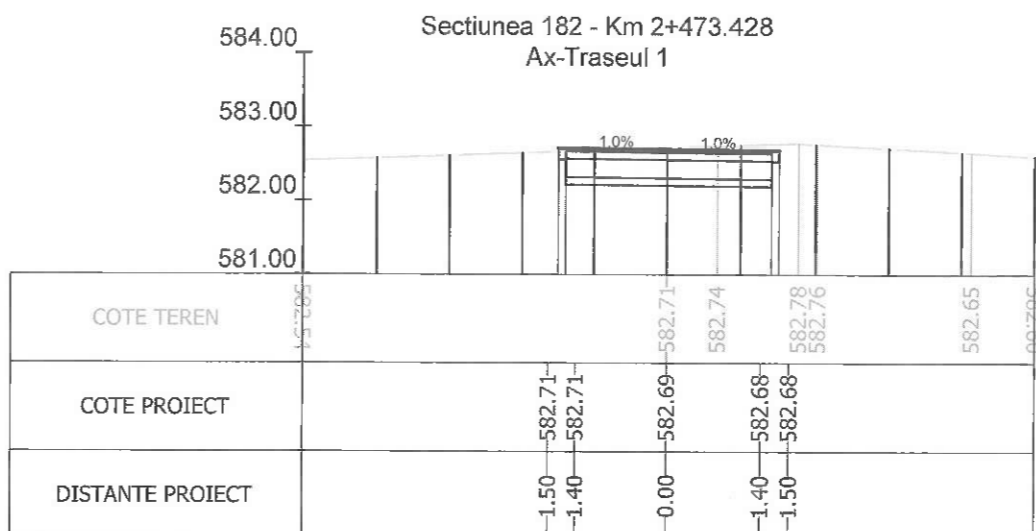

Sectiunea 184 - Km 2+500
Ax-Traseul 1



Index	Data	Observatii	Rev. 5
A			
		Beneficiar:	MUNICIPIUL BRASOV Bulevardul Eroilor 8, Brasov 500007
		Nr. proiect	73 / 2020
		Titlu proiect:	INFRASTRUCTURA INTEGRATA PENTRU CICLISM SI TRAFIC PIETONAL CU FACILITATI COMPLEMENTARE - TRASEUL 1
Scara 1:100 Data 07/2023		Titlu plansa:	PROFILURI TRANSVERSALE TIP
Faza P.T. Nr. plansa PTC 20			

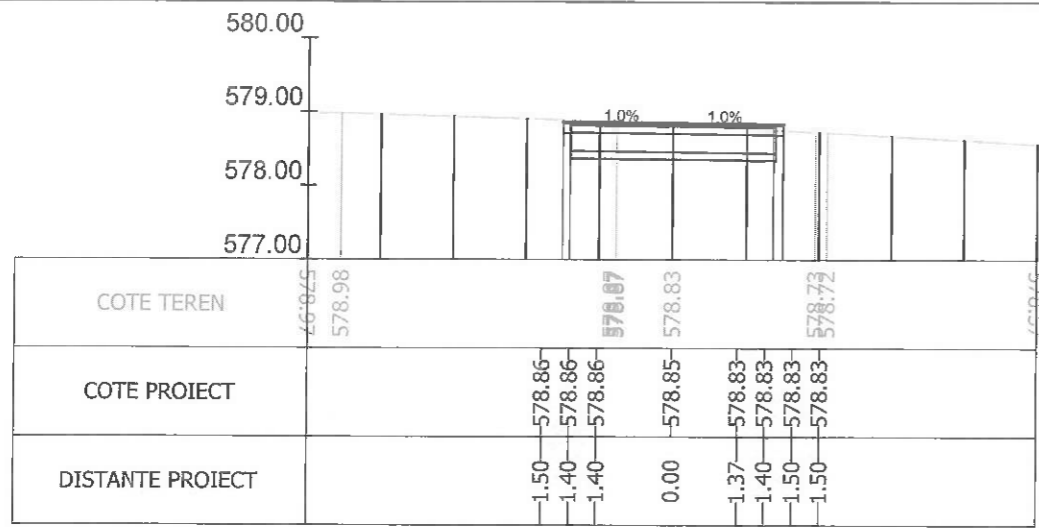

Sectiunea 197 - Km 2+721.608
Ax-Traseul 1

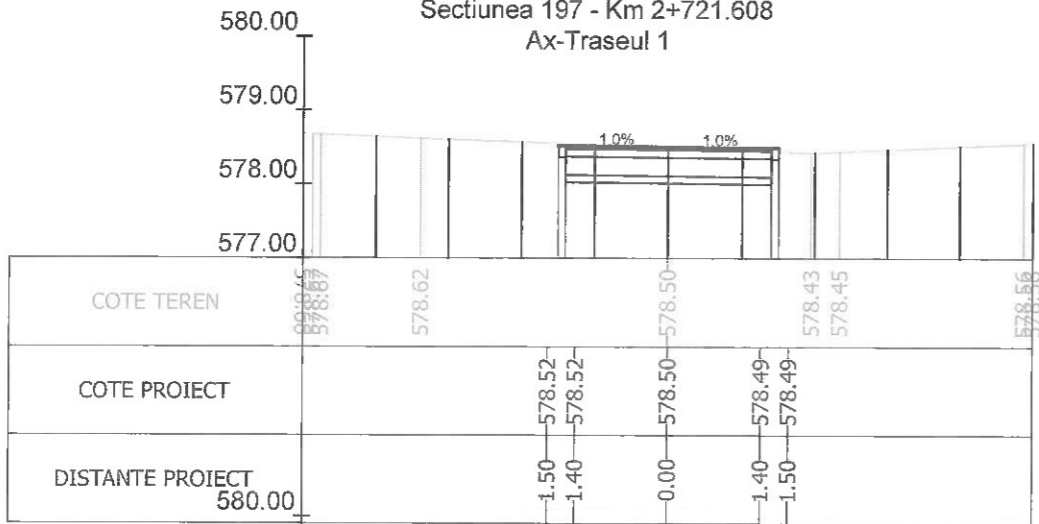

Sectiunea 199 - Km 2+750
Ax-Traseul 1

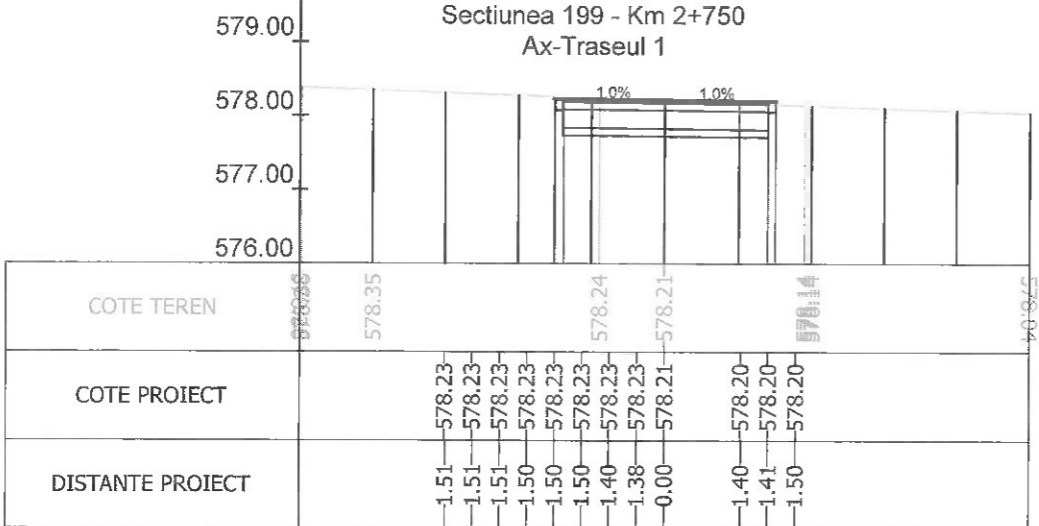

Sectiunea 201 - Km 2+777.192
Ax-Traseul 1

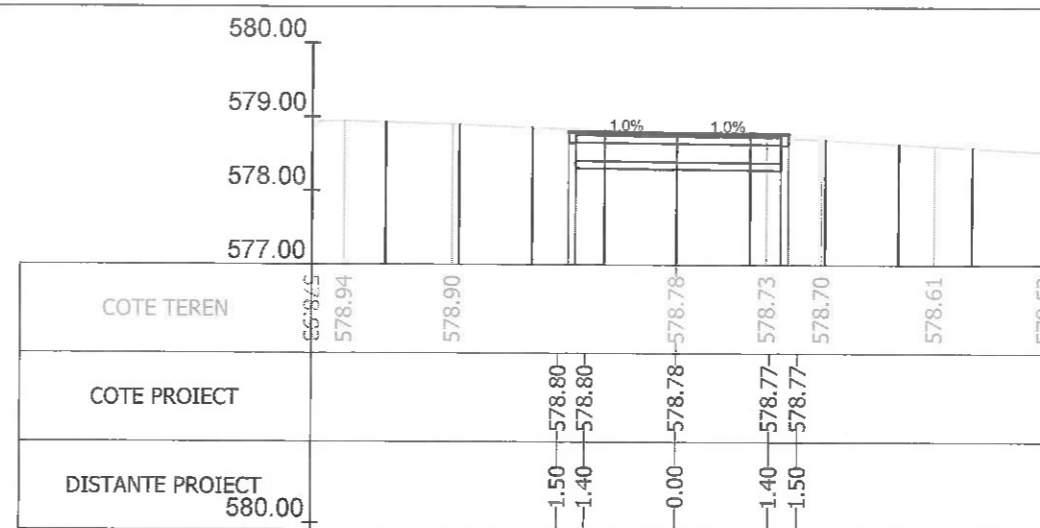

Sectiunea 198 - Km 2+725
Ax-Traseul 1

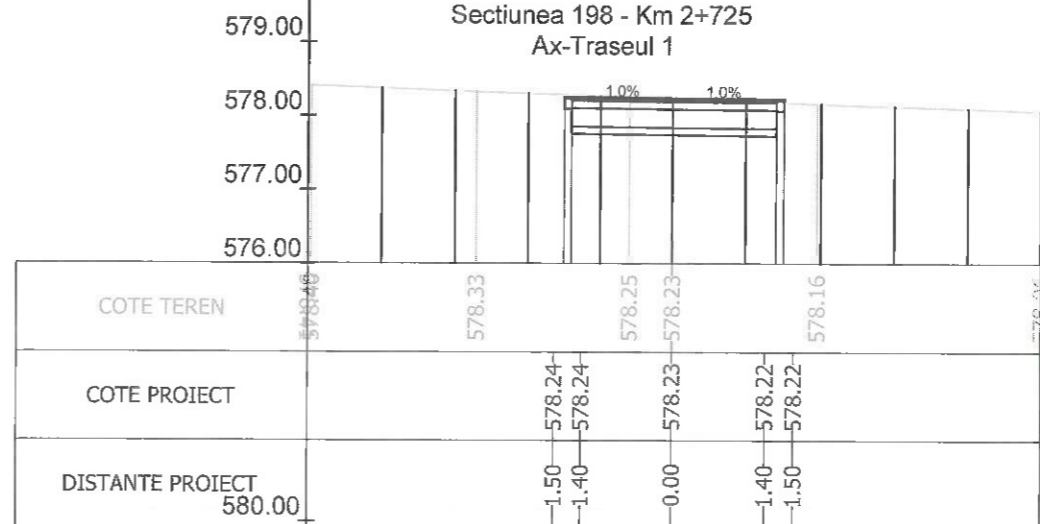

Sectiunea 200 - Km 2+775
Ax-Traseul 1

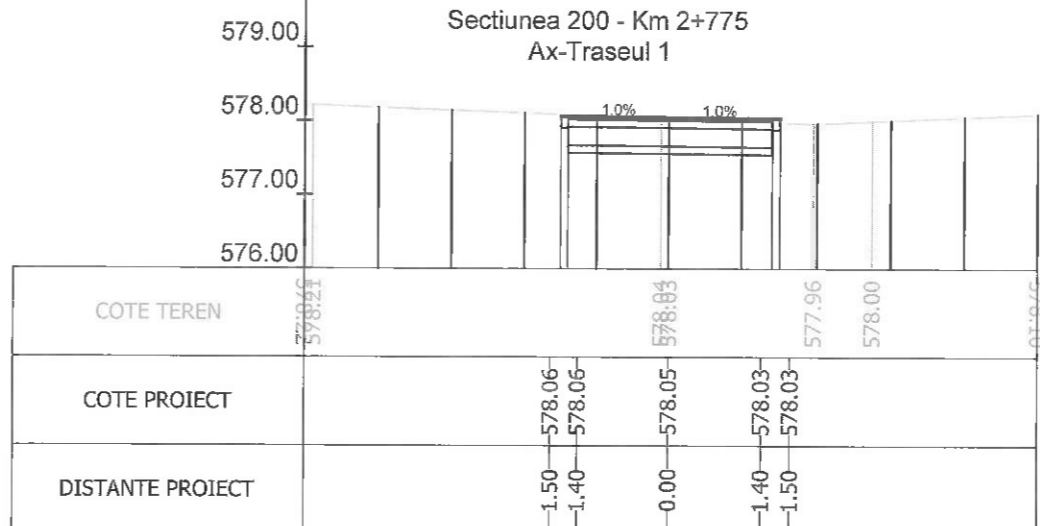

Sectiunea 202 - Km 2+800
Ax-Traseul 1



Index	Data	Observatii	Rev. 5
A			
		Beneficiar:	MUNICIPIUL BRASOV Bulevardul Eroilor 8, Brasov 500007
		Titlu proiect:	INFRASTRUCTURA INTEGRATA PENTRU CICLISM SI TRAFIC PIETONAL CU FACILITATI COMPLEMENTARE - TRASEUL 1
		Titlu plansa:	PROFILURI TRANSVERSALE TIP
Sef Proiect	Ing. A. Buta	Scara	Nr. proiect 73 / 2020
Proiectat	Ing. A. Buta	1:100	Faza P.T.
Desenat	Ing. S. Patroi	Data	Nr. plansa PTC 23
Verificat		07/2023	

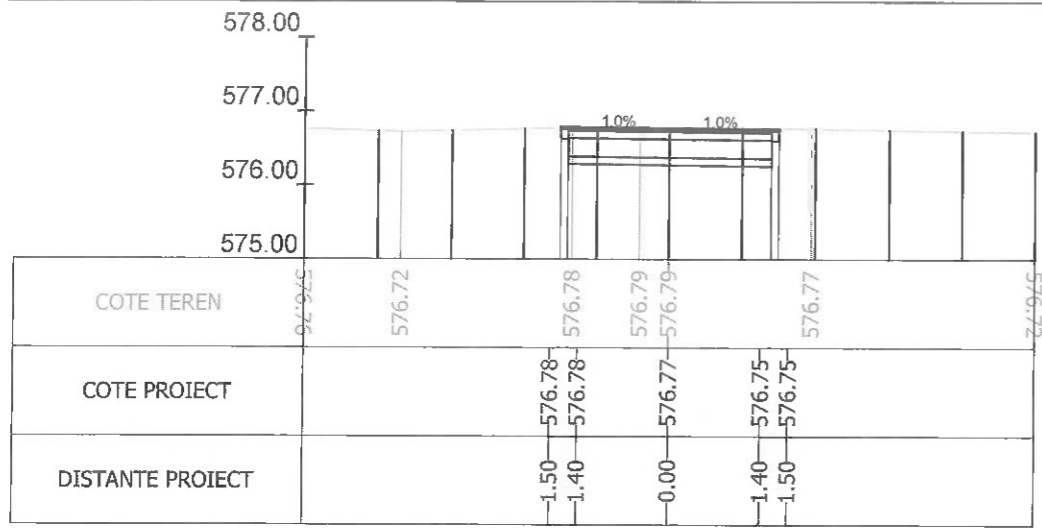

Sectiunea 209 - Km 2+912.940
Ax-Traseul 1

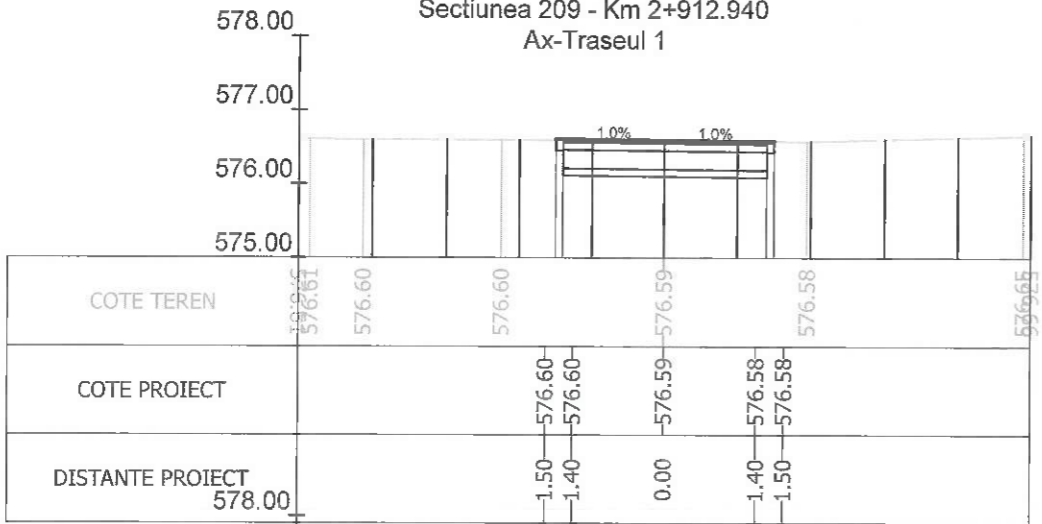

Sectiunea 211 - Km 2+925
Ax-Traseul 1

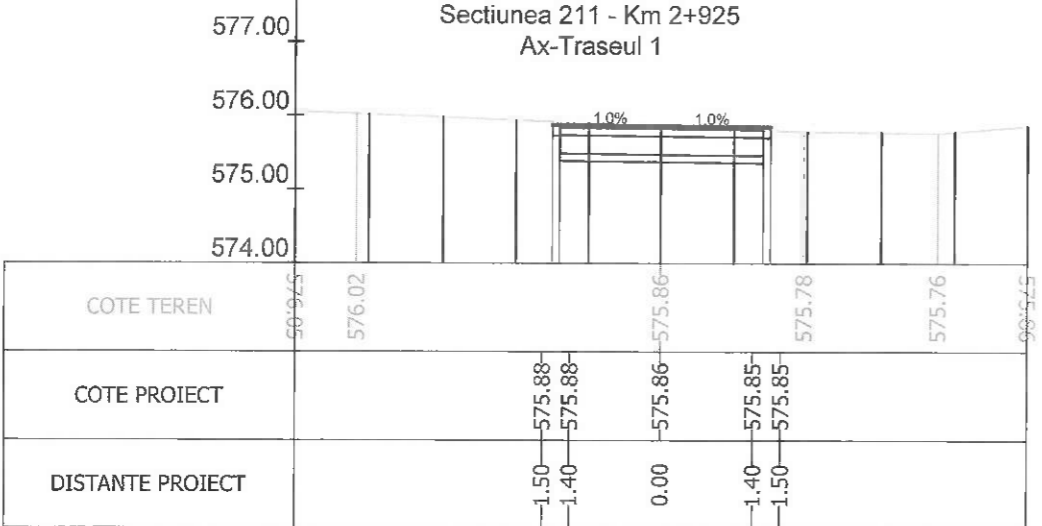

Sectiunea 213 - Km 2+975
Ax-Traseul 1

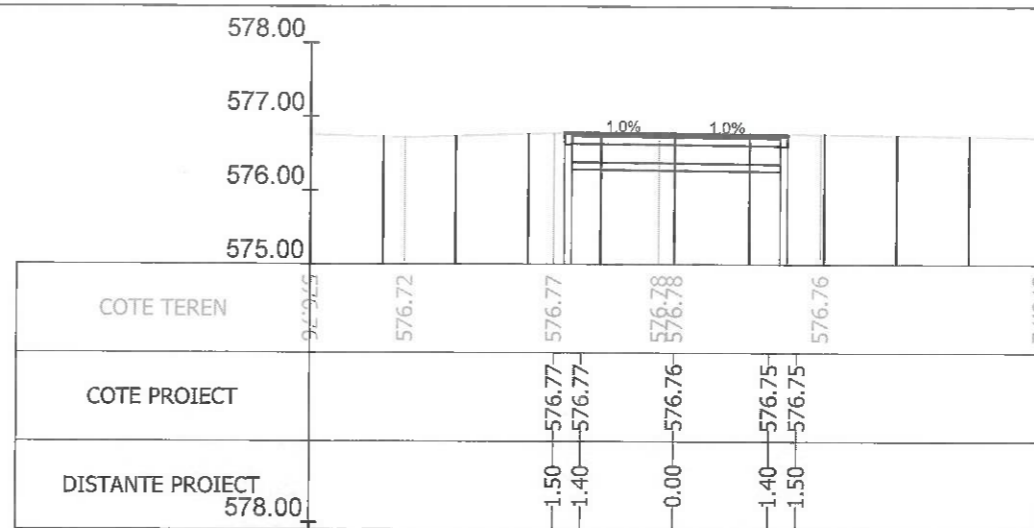

Sectiunea 210 - Km 2+913.314
Ax-Traseul 1

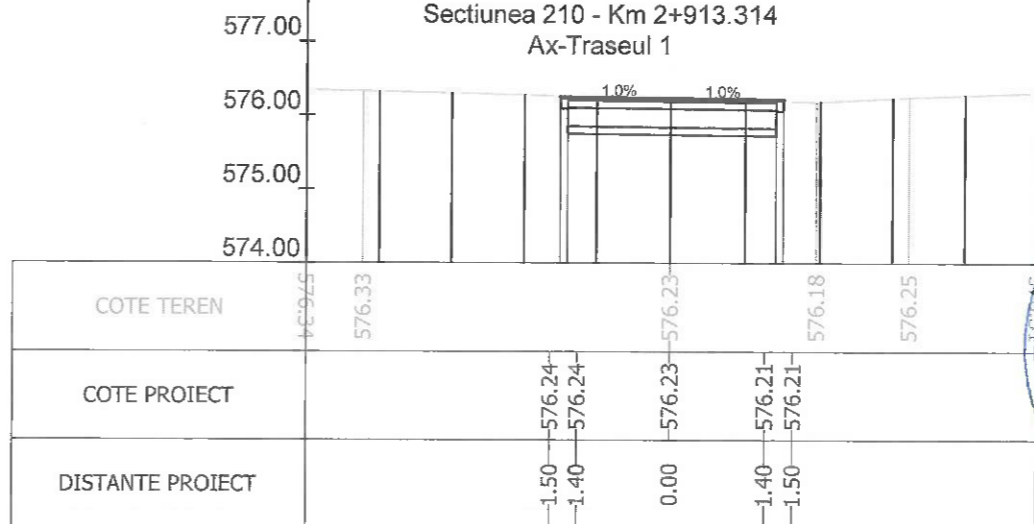

Sectiunea 212 - Km 2+950
Ax-Traseul 1

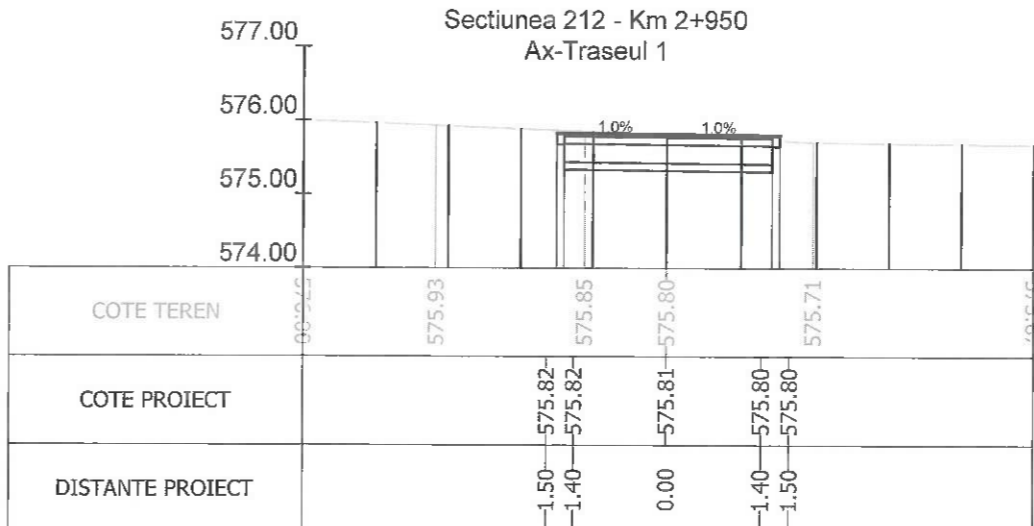

Sectiunea 214 - Km 2+979.961
Ax-Traseul 1

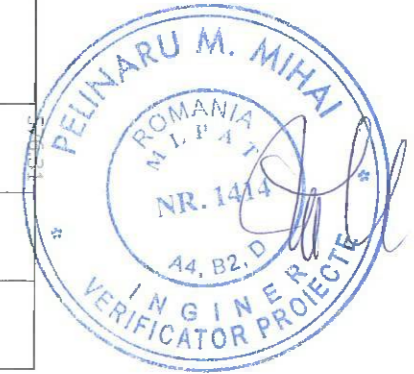

Index	Data	Observatii	Rev. 5
A			
			Beneficiar: MUNICIPIUL BRASOV Bulevardul Eroilor 8, Brasov 500007
Sef Proiect: Ing. A. Buta Proiectat: Ing. A. Buta Desenat: Ing. S. Patroi Verificat:			Nr. proiect: 73 / 2020 Faza P.T.
Scara: 1:100 Data: 07/2023			Nr. plansa: PTC 25
Titlu proiect: INFRASTRUCTURA INTEGRATA PENTRU CICLISM SI TRAFIC PIETONAL CU FACILITATI COMPLEMENTARE - TRASEUL 1			Titlu plansa: PROFILURI TRANSVERSALE TIP

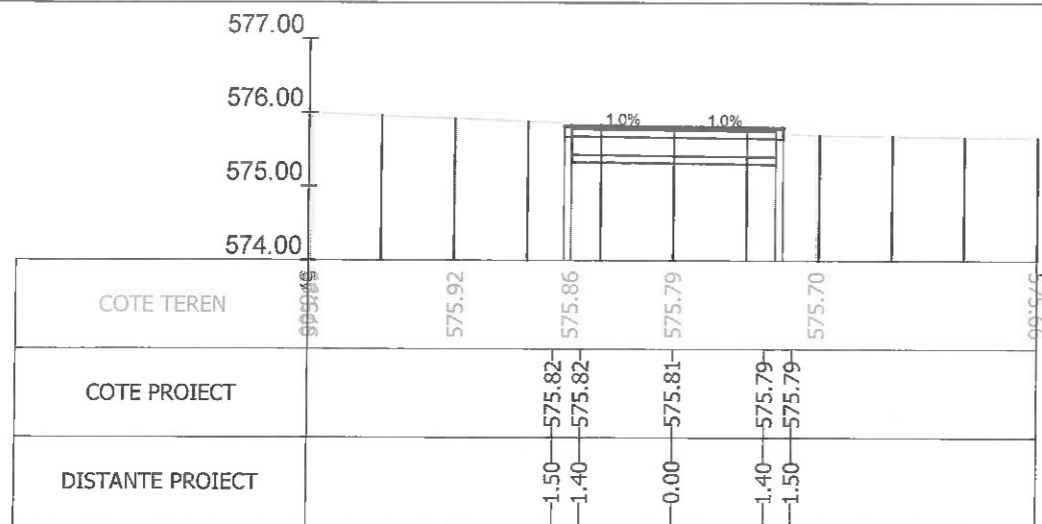

Sectiunea 215 - Km 2+980.434
Ax-Traseul 1

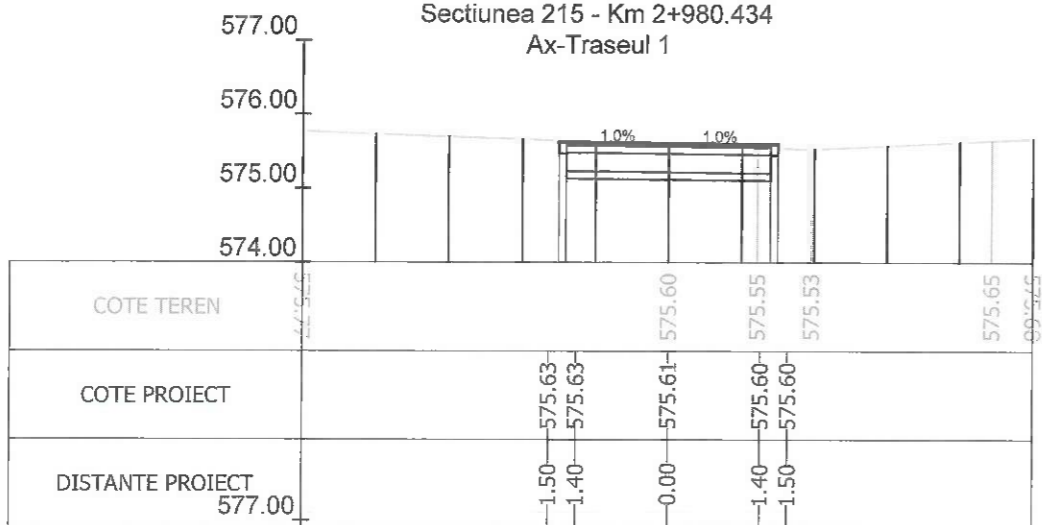

Sectiunea 216 - Km 2+980.907
Ax-Traseul 1

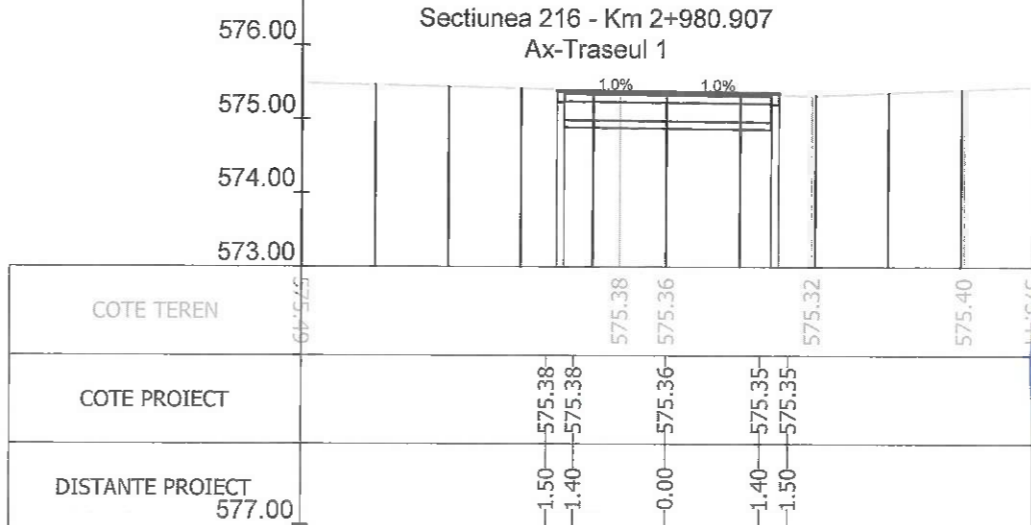
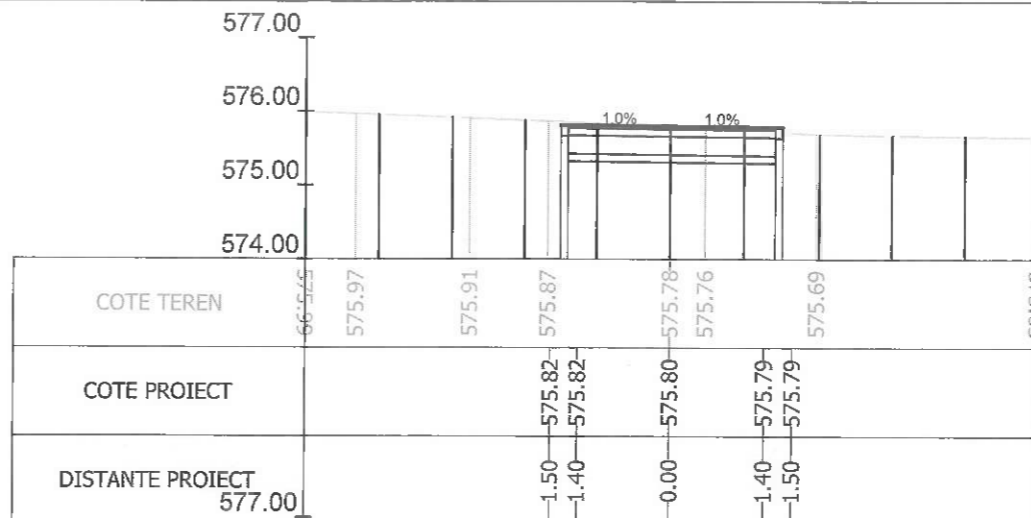

Sectiunea 218 - Km 3+025
Ax-Traseul 1

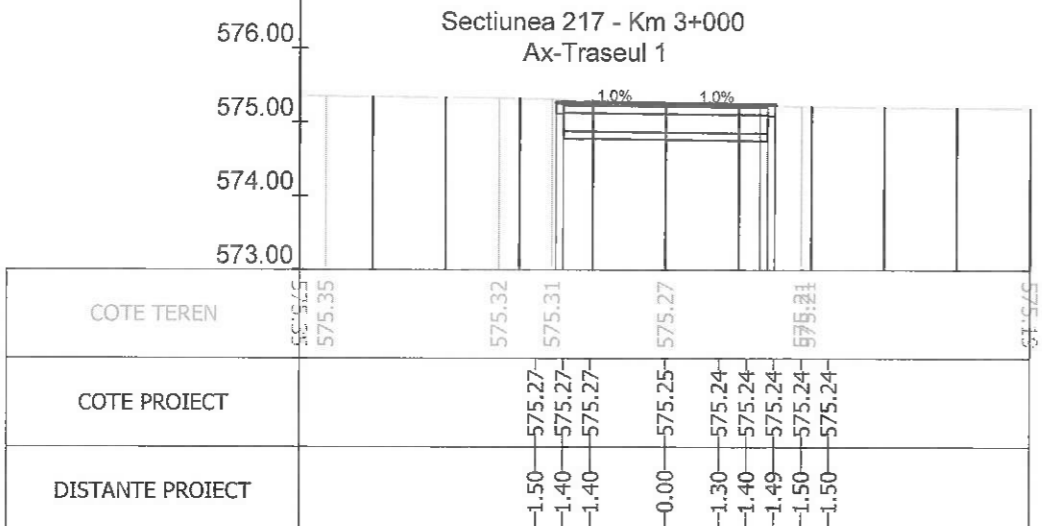

Sectiunea 219 - Km 3+037.896
Ax-Traseul 1

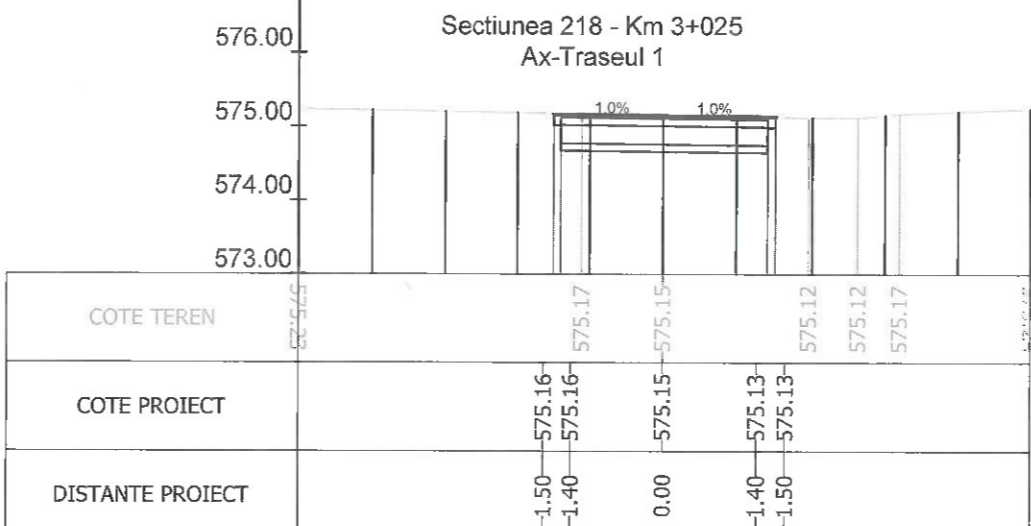

Sectiunea 220 - Km 3+050
Ax-Traseul 1



Index	Data	Observatii	Rev. 5
A			
		Beneficiar:	MUNICIPIUL BRASOV Bulevardul Eroilor 8, Brasov 500007
		Titlu proiect:	INFRASTRUCTURA INTEGRATA PENTRU CICLISM SI TRAFIC PIETONAL CU FACILITATI COMPLEMENTARE - TRASEUL 1
		Titlu plansa:	PROFILURI TRANSVERSALE TIP
Sef Proiect	Ing. A. Buta	Scara	1:100
Proiectat	Ing. A. Buta	Data	07/2023
Desenat	Ing. S. Patroi		
Verificat			
			Nr. proiect 73 / 2020
			Faza P.T.
			Nr. plansa PTC 26

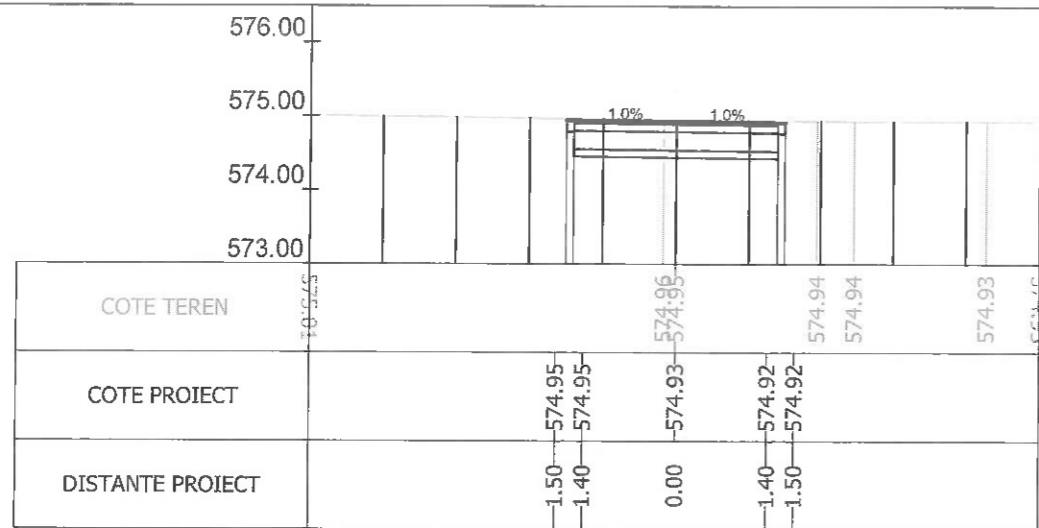

Sectiunea 221 - Km 3+075
Ax-Traseul 1

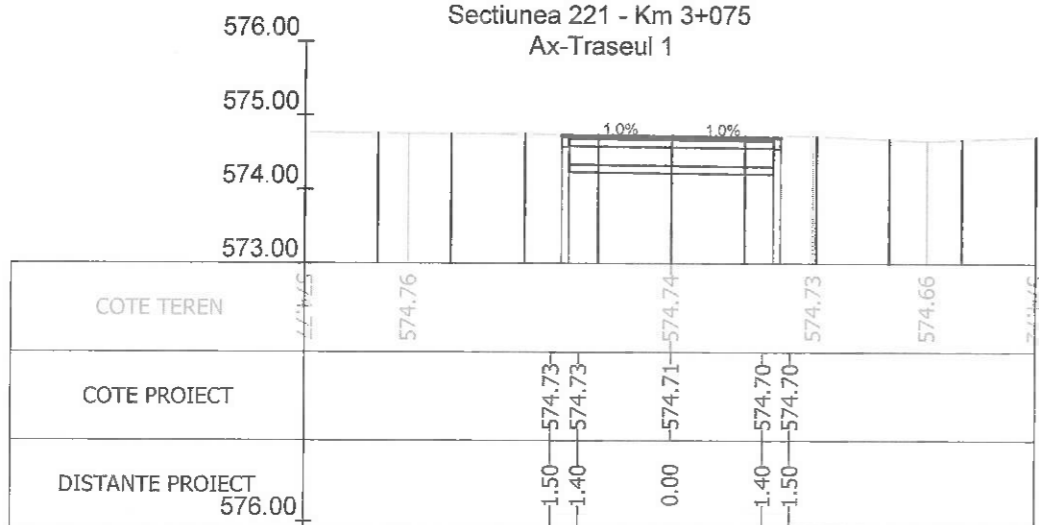

Sectiunea 222 - Km 3+083.337
Ax-Traseul 1

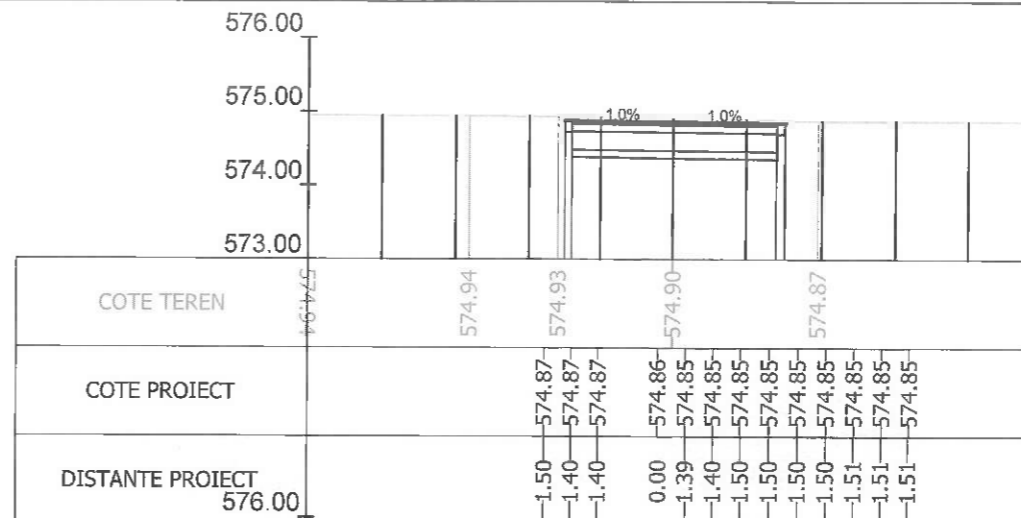

Sectiunea 224 - Km 3+125
Ax-Traseul 1

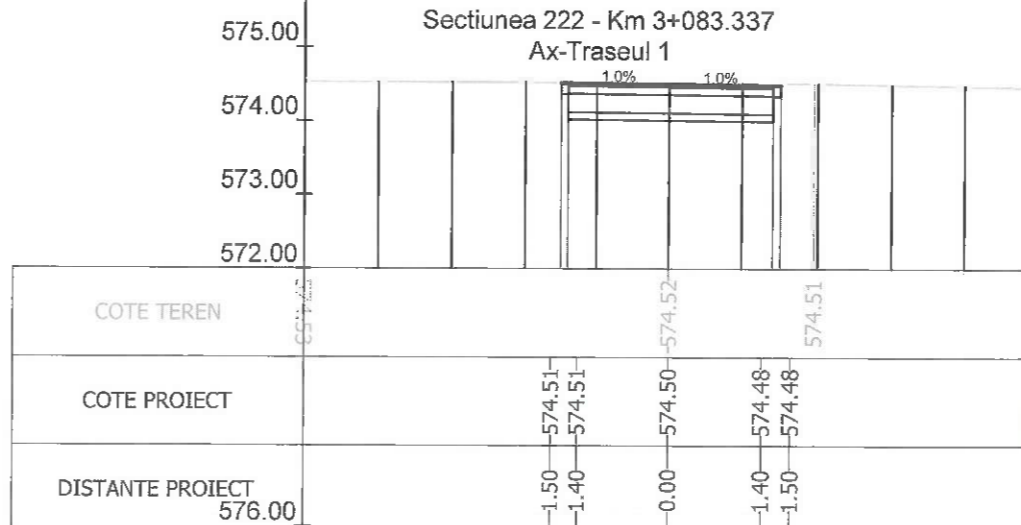

Sectiunea 225 - Km 3+130.581
Ax-Traseul 1

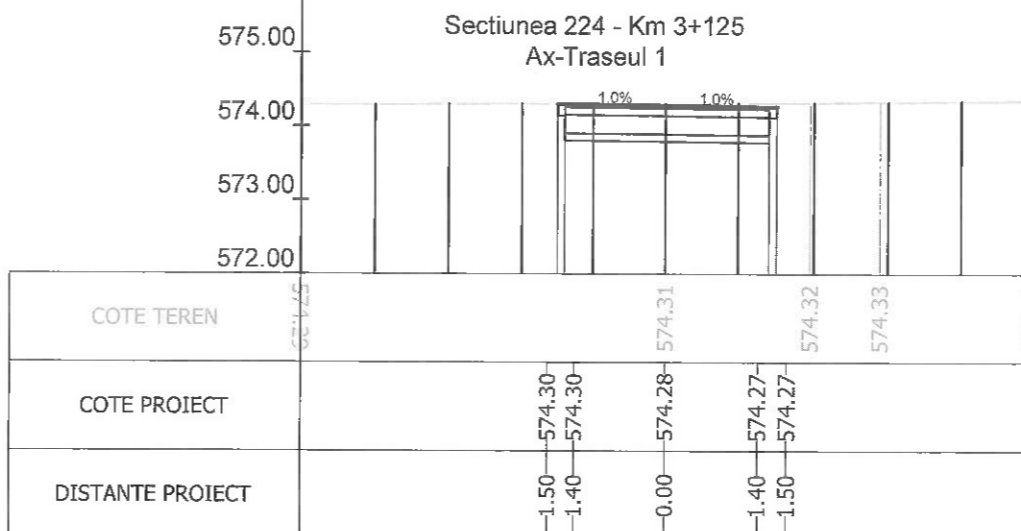

Sectiunea 226 - Km 3+150
Ax-Traseul 1



Index	Data	Observatii	Rev. 5
A			
		Beneficiar:	MUNICIPIUL BRASOV Bulevardul Eroilor 8, Brasov 500007
		Nr. proiect	73 / 2020
Sef Proiect: Ing. A. Buta Proiectat: Ing. A. Buta Desenal: Ing. S. Patroi Verificat:		Titlu proiect:	INFRASTRUCTURA INTEGRATA PENTRU CICLISM SI TRAFIC PIETONAL CU FACILITATI COMPLEMENTARE - TRASEUL 1
Scara: 1:100 Data: 07/2023		Faza	P.T.
		Titlu plansa:	PROFILURI TRANSVERSALE TIP
		Nr. plansa	PTC 27

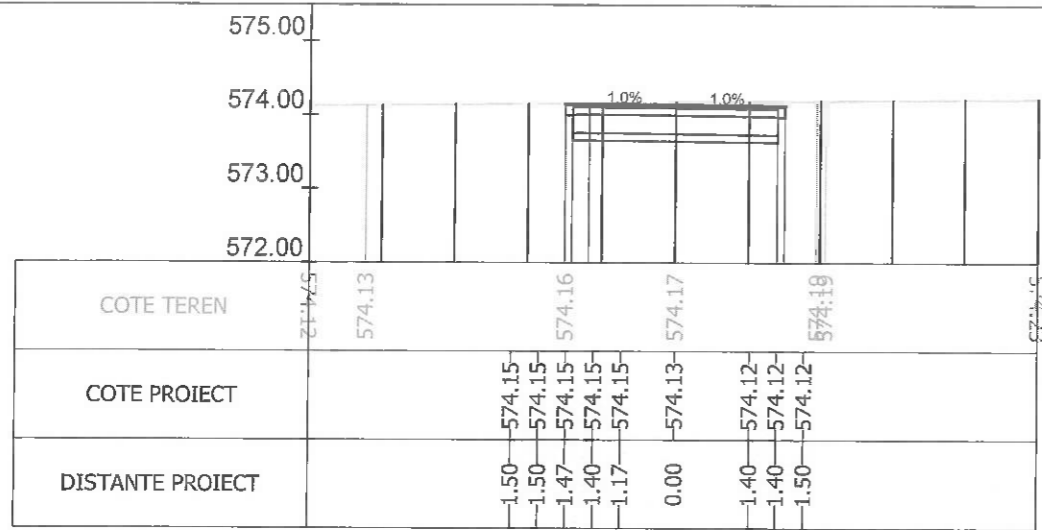

Sectiunea 227 - Km 3+166.983
Ax-Traseul 1

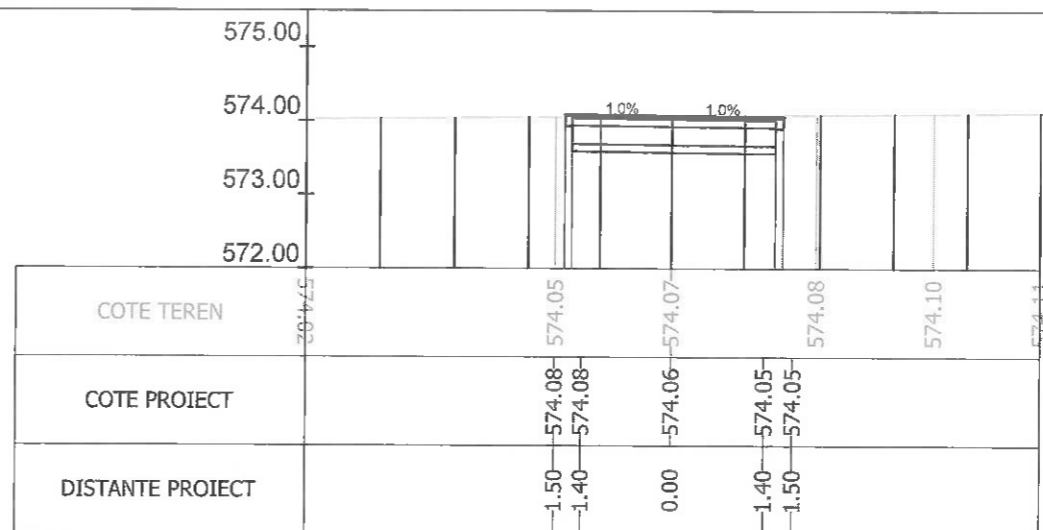

Sectiunea 228 - Km 3+175
Ax-Traseul 1

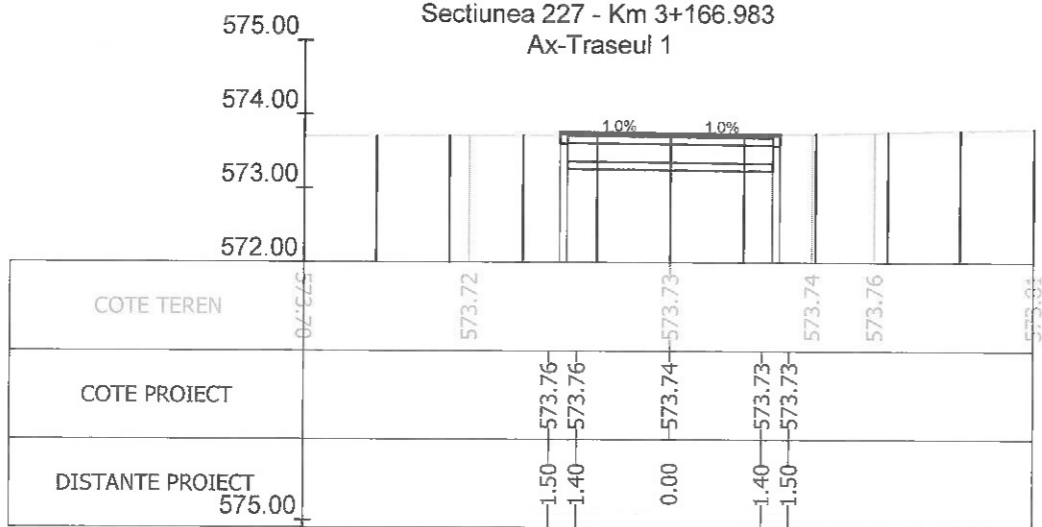

Sectiunea 229 - Km 3+200
Ax-Traseul 1

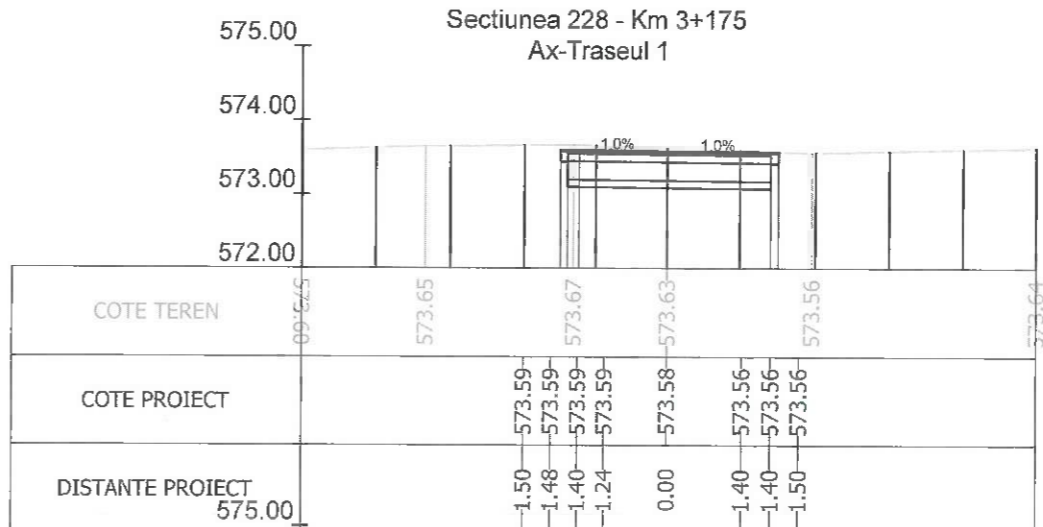

Sectiunea 230 - Km 3+212.759
Ax-Traseul 1

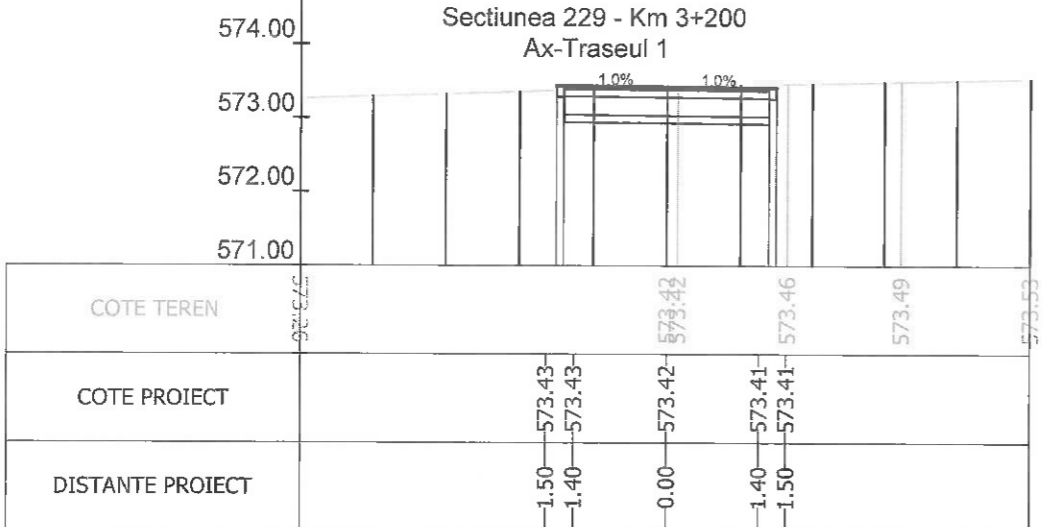

Sectiunea 231 - Km 3+225
Ax-Traseul 1

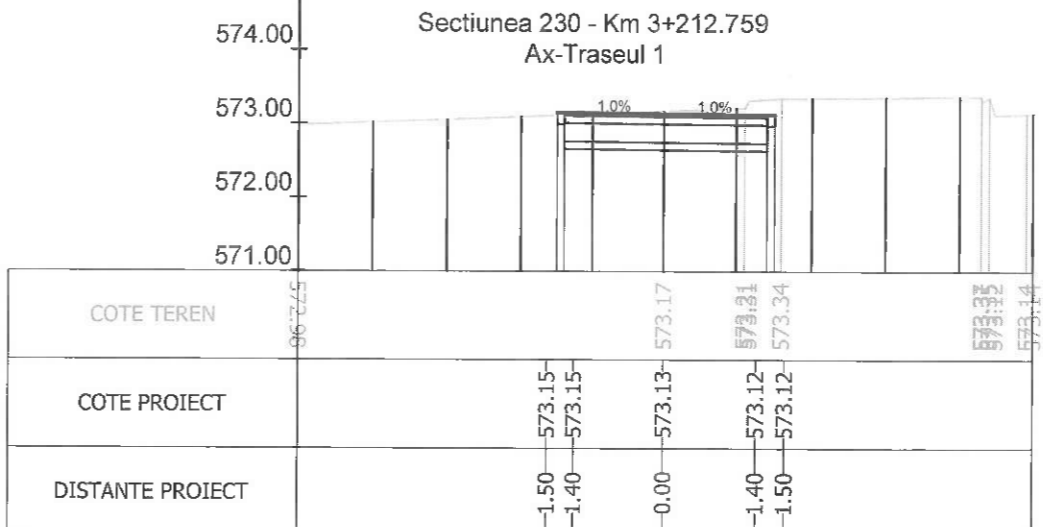

Sectiunea 232 - Km 3+250
Ax-Traseul 1

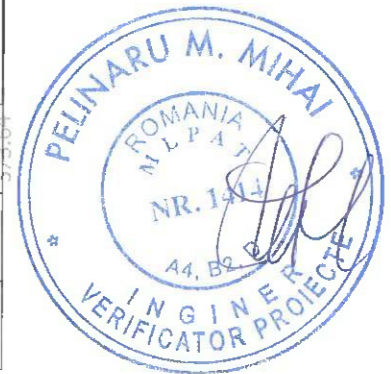

Index	Data	Observatii	Rev. 5
A			
		Beneficiar:	MUNICIPIUL BRASOV Bulevardul Eroilor 8, Brasov 500007
		Nr. proiect	73 / 2020
		Titlu proiect:	INFRASTRUCTURA INTEGRATA PENTRU CICLISM SI TRAFIC PIETONAL CU FACILITATI COMPLEMENTARE - TRASEUL 1
		Faza	P.T.
		Titlu plansa:	PROFILURI TRANSVERSALE TIP
		Nr. plansa	PTC 28
Sef Proiect	Ing. A. Buta	Scara	1:100
Proiectat	Ing. A. Buta	Data	07/2023
Desenat	Ing. S. Patroi		
Verificat			

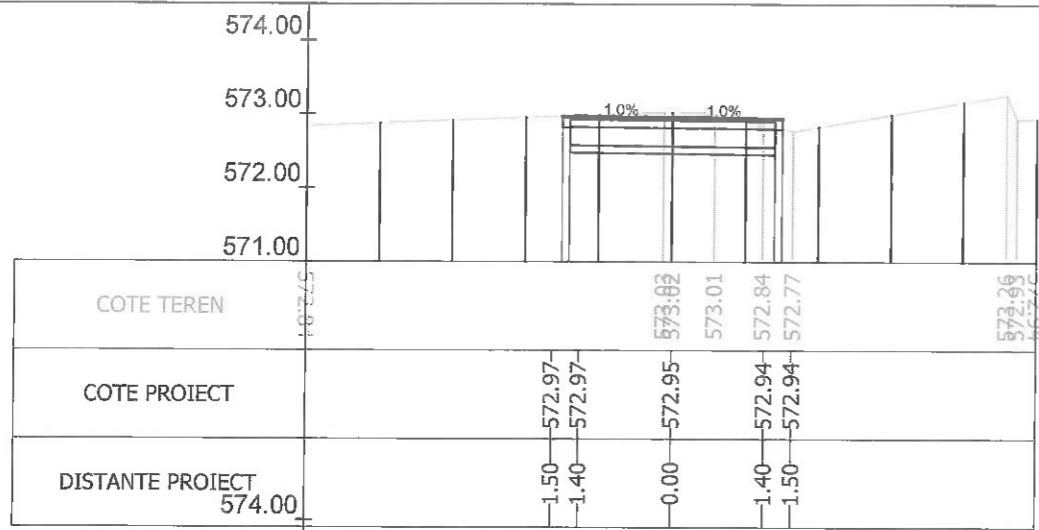

Sectiunea 233 - Km 3+257.500
Ax-Traseul 1

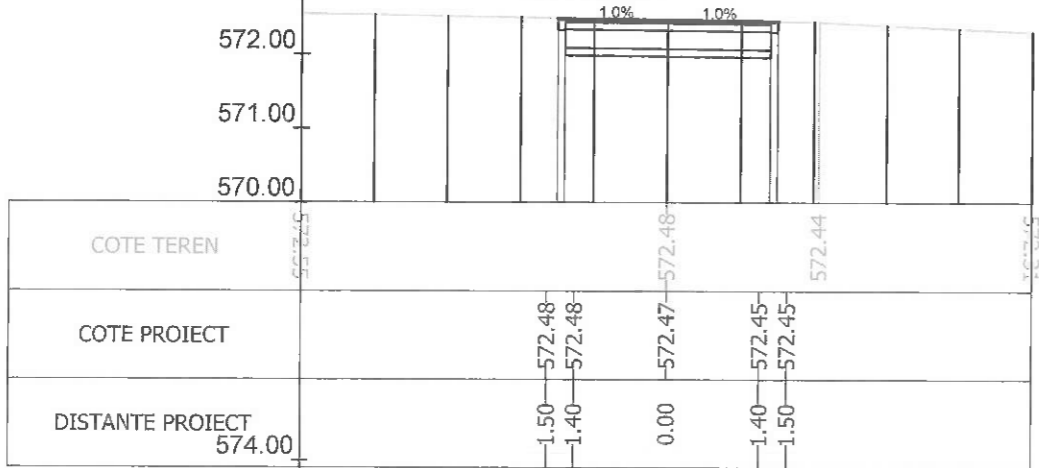

Sectiunea 235 - Km 3+274.525
Ax-Traseul 1

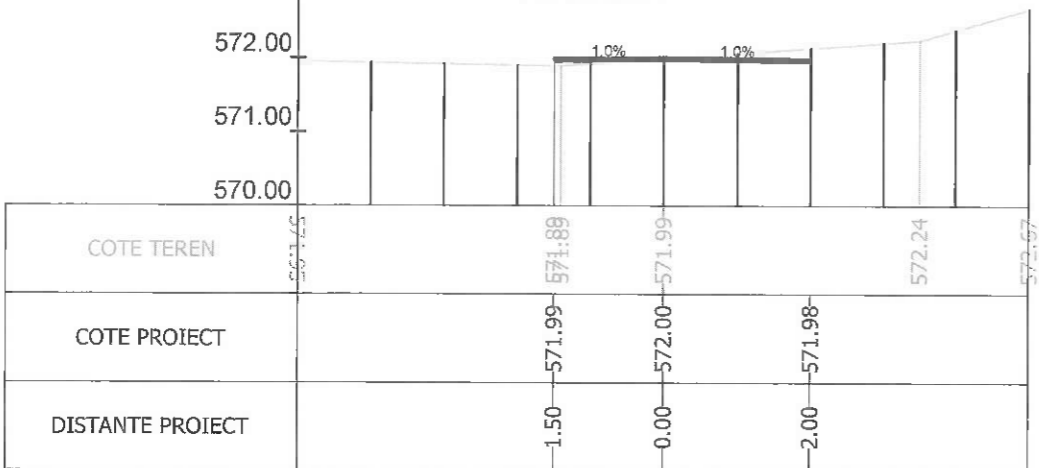

Sectiunea 237 - Km 3+300
Ax-Traseul 1

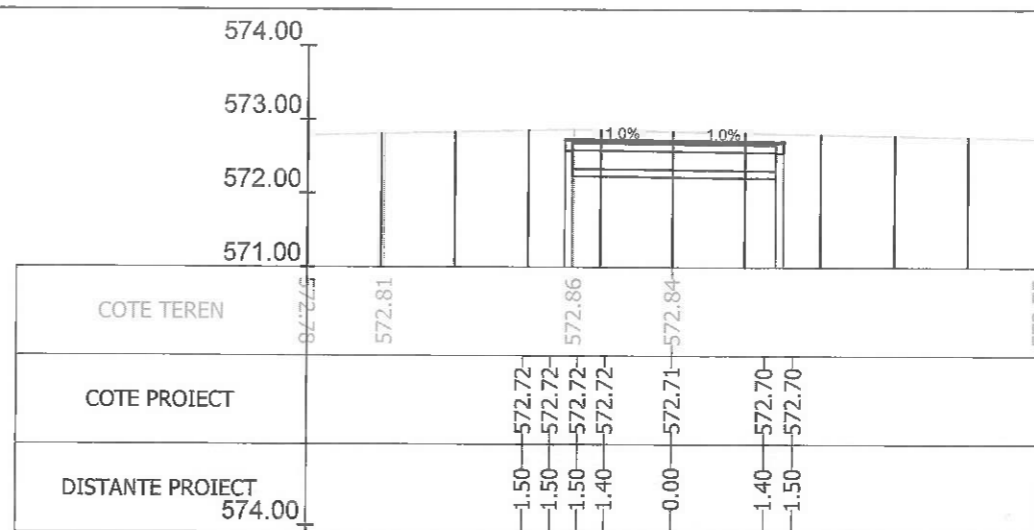

Sectiunea 234 - Km 3+266.013
Ax-Traseul 1

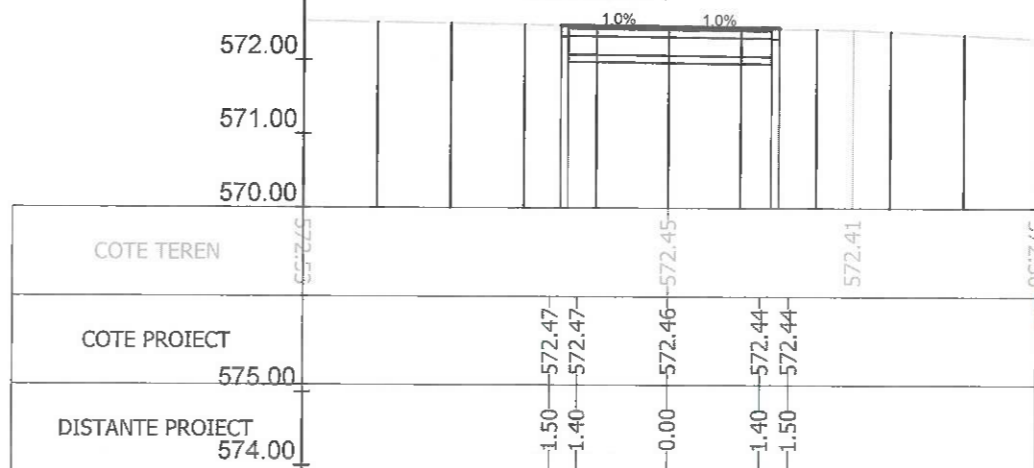

Sectiunea 236 - Km 3+275
Ax-Traseul 1

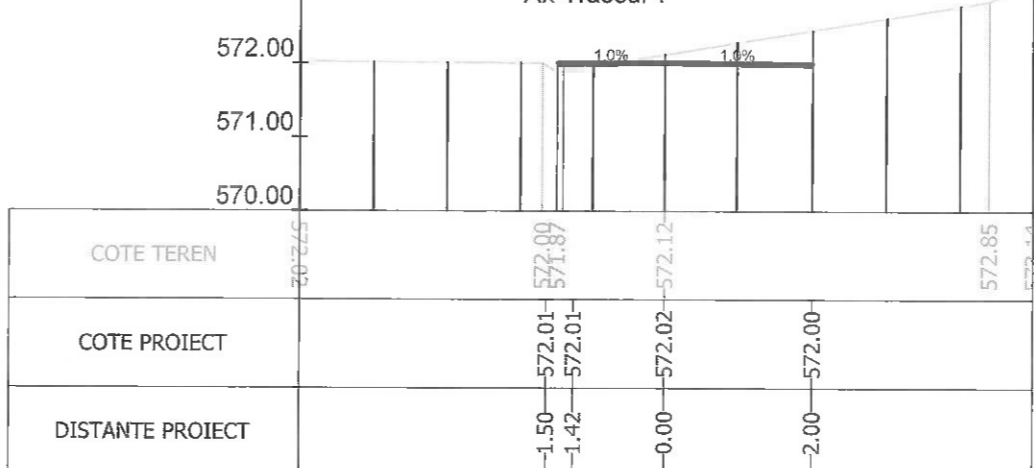

Sectiunea 238 - Km 3+307.955
Ax-Traseul 1

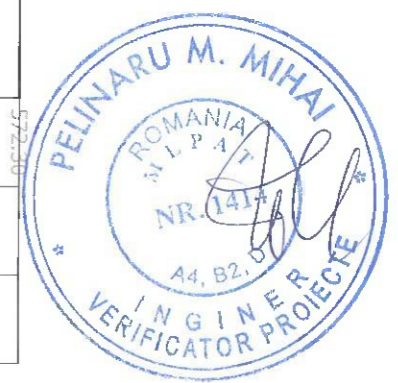

Index	Data	Observatii	Rev. 5
A			
		Beneficiar:	MUNICIPIUL BRASOV Bulevardul Eroilor 8, Brasov 500007
		Beneficiar:	MUNICIPIUL BRASOV Bulevardul Eroilor 8, Brasov 500007
		Titlu proiect:	INFRASTRUCTURA INTEGRATA PENTRU CICLISM SI TRAFIC PIETONAL CU FACILITATI COMPLEMENTARE - TRASEUL 1
		Titlu plansa:	PROFILURI TRANSVERSALE TIP
Sef Proiect	Ing. A. Buta	Scara	1:100
Proiectat	Ing. A. Buta	Data	07/2023
Desenat	Ing. S. Patroi		
Verificat			
			Nr. proiect 73 / 2020
			Faza P.T.
			Nr. plansa PTC 29

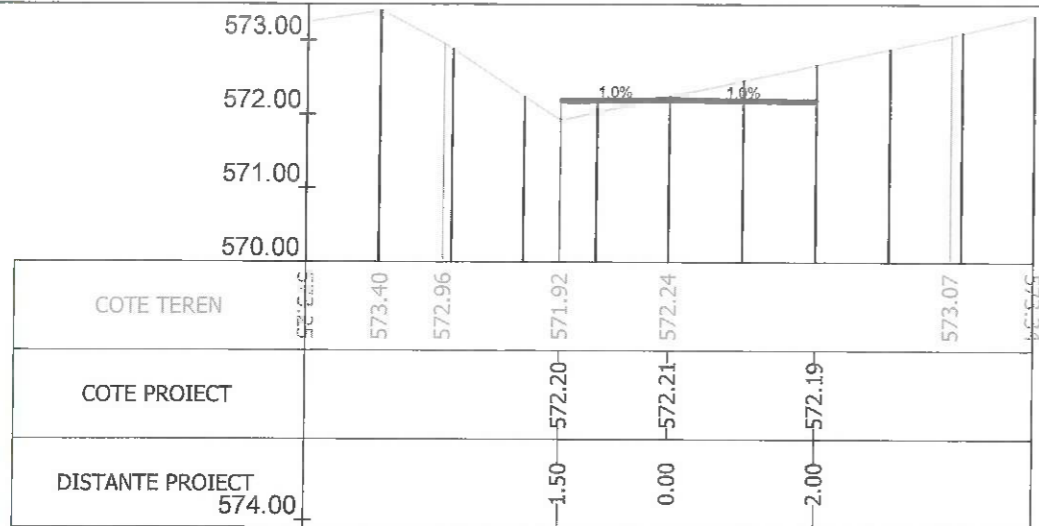

Sectiunea 239 - Km 3+325
Ax-Traseul 1

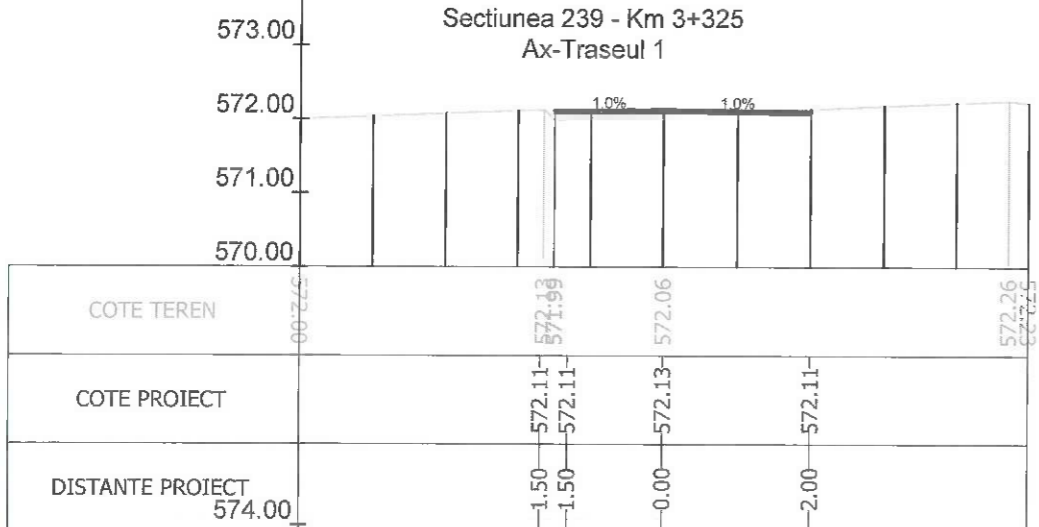

Sectiunea 241 - Km 3+352.192
Ax-Traseul 1

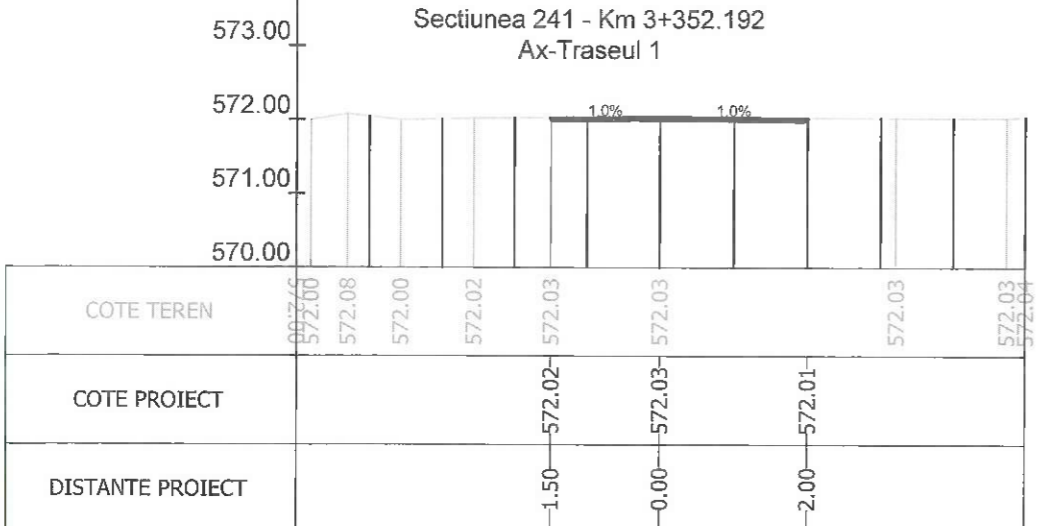

Sectiunea 243 - Km 3+375
Ax-Traseul 1

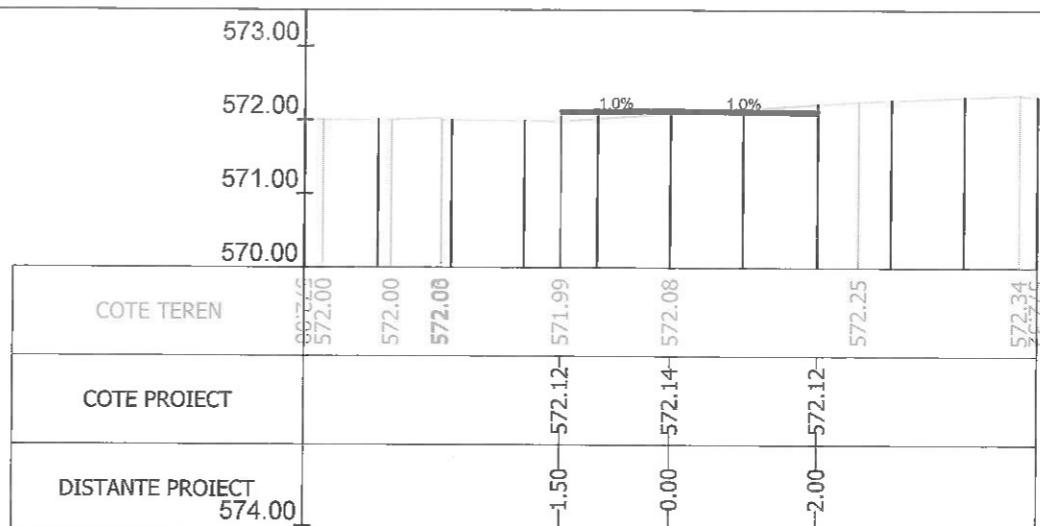

Sectiunea 240 - Km 3+350
Ax-Traseul 1

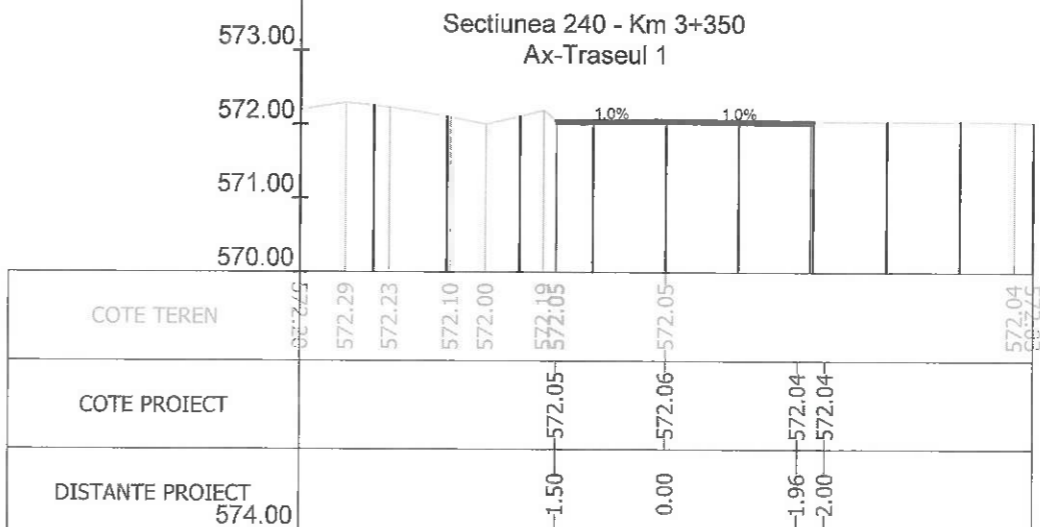

Sectiunea 242 - Km 3+368.860
Ax-Traseul 1

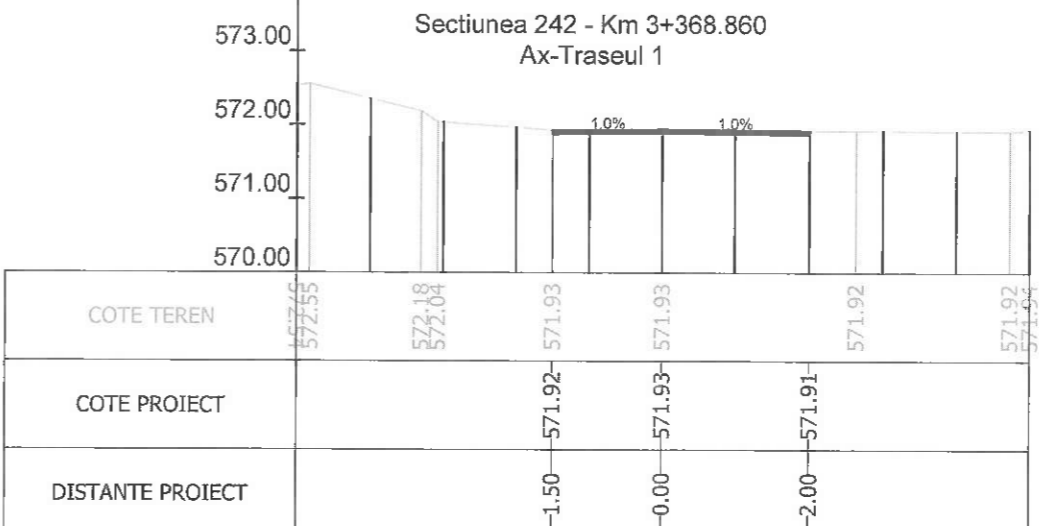

Sectiunea 244 - Km 3+400
Ax-Traseul 1



Index	Data	Observatii	Rev. 5
A			
			Beneficiar:
			MUNICIPIUL BRASOV Bulevardul Eroilor 8, Brasov 500007
			Nr. proiect 73 / 2020
			Titlu proiect:
			INFRASTRUCTURA INTEGRATA PENTRU CICLISM SI TRAFIC PIETONAL CU FACILITATI COMPLEMENTARE - TRASEUL 1
			Faza P.T.
			Titlu plansa:
			PROFILURI TRANSVERSALE TIP
			Nr. plansa PTC 30
Sef Proiect	Ing. A. Buta	Scara 1:100	
Proiectat	Ing. A. Buta	Data 07/2023	
Desenat	Ing. S. Patroi		
Verificat			

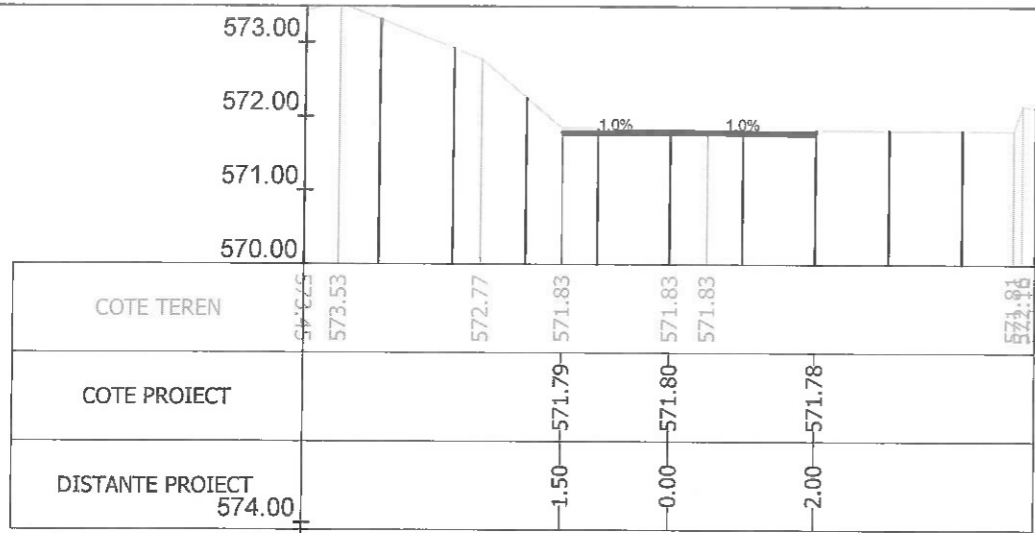

Sectiunea 245 - Km 3+425
Ax-Traseul 1

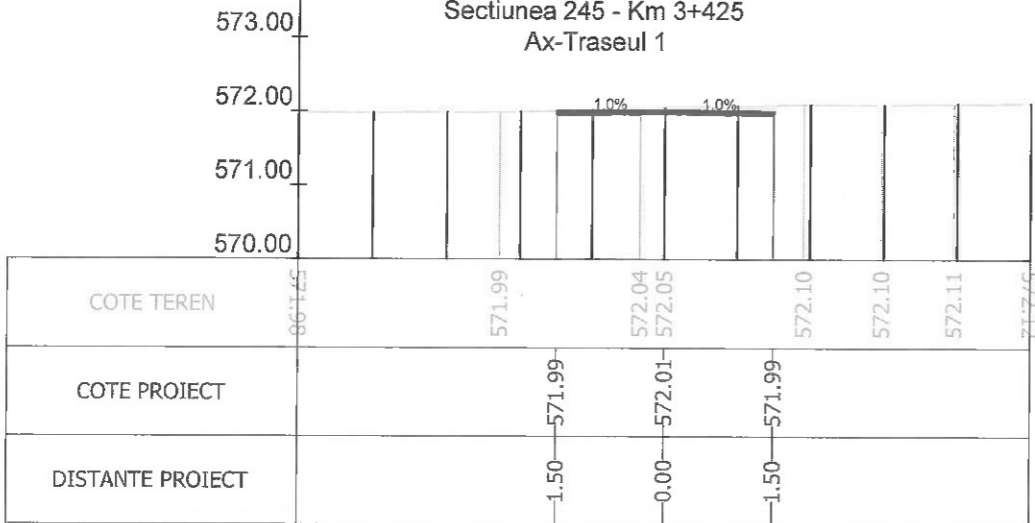

Sectiunea 273 - Km 3+875
Ax-Traseul 1

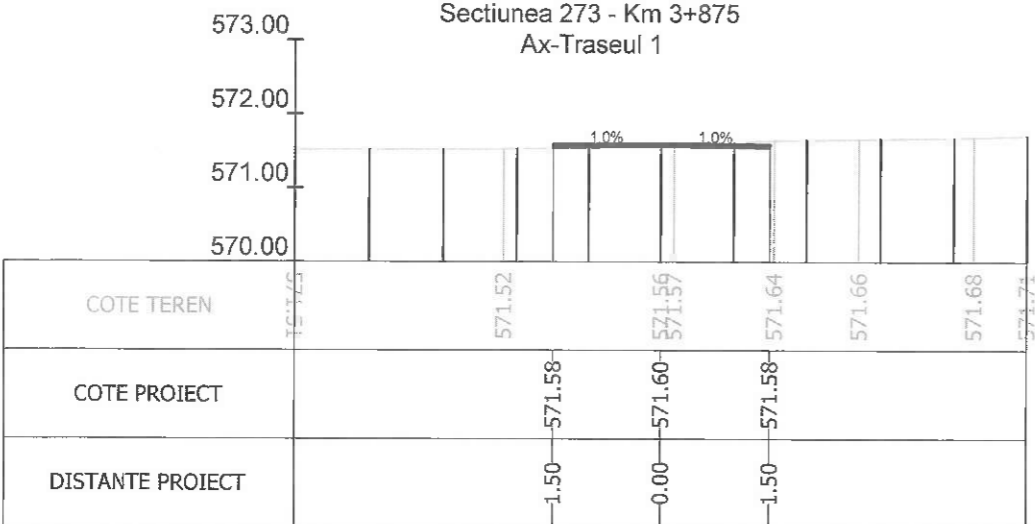

Sectiunea 275 - Km 3+925
Ax-Traseul 1

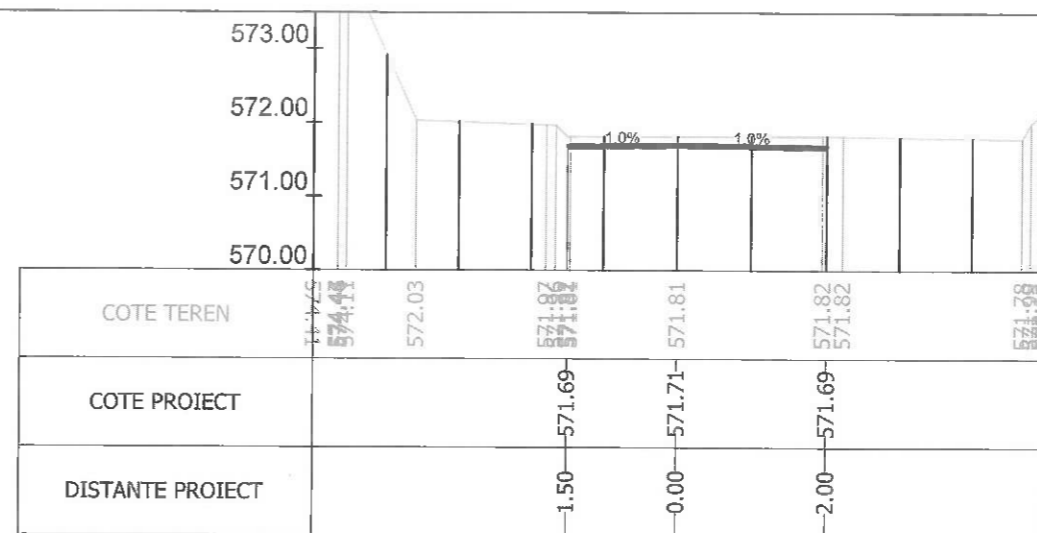

Sectiunea 246 - Km 3+431.193
Ax-Traseul 1

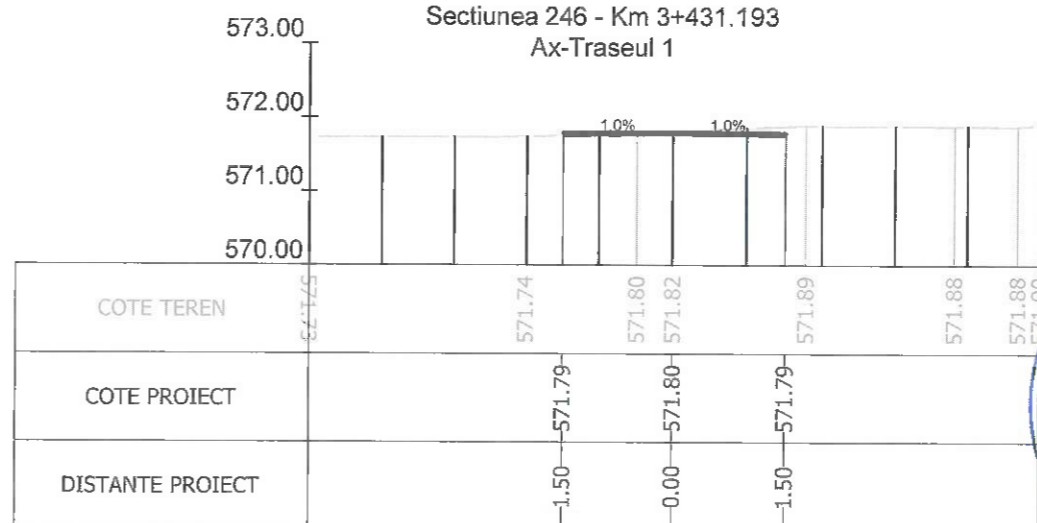

Sectiunea 274 - Km 3+900
Ax-Traseul 1

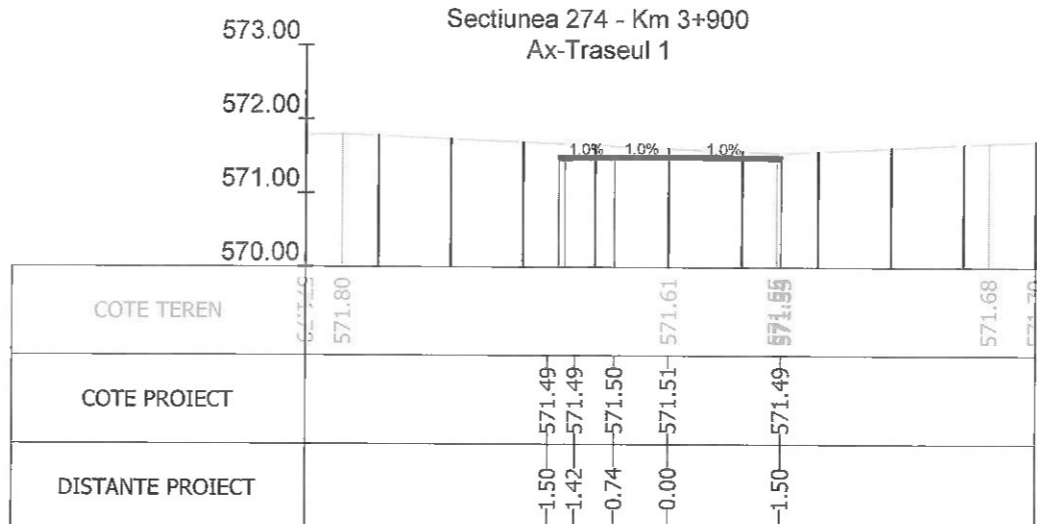

Sectiunea 276 - Km 3+935.939
Ax-Traseul 1



Index	Data	Observatii	Rev. 5
A			
		Beneficiar:	MUNICIPIUL BRASOV Bulevardul Eroilor 8, Brasov 500007
		Nr. proiect:	73 / 2020
		Titlu proiect:	INFRASTRUCTURA INTEGRATA PENTRU CICLISM SI TRAFIC PIETONAL CU FACILITATI COMPLEMENTARE - TRASEUL 1
		Faza:	P.T.
		Titlu plansa:	Nr. plansa PTC 31
		Scara:	1:100
		Data:	07/2023
		Sef Proiect:	Ing. A. Buta
		Proiectat:	Ing. A. Buta
		Desenat:	Ing. S. Patroi
		Verificat:	

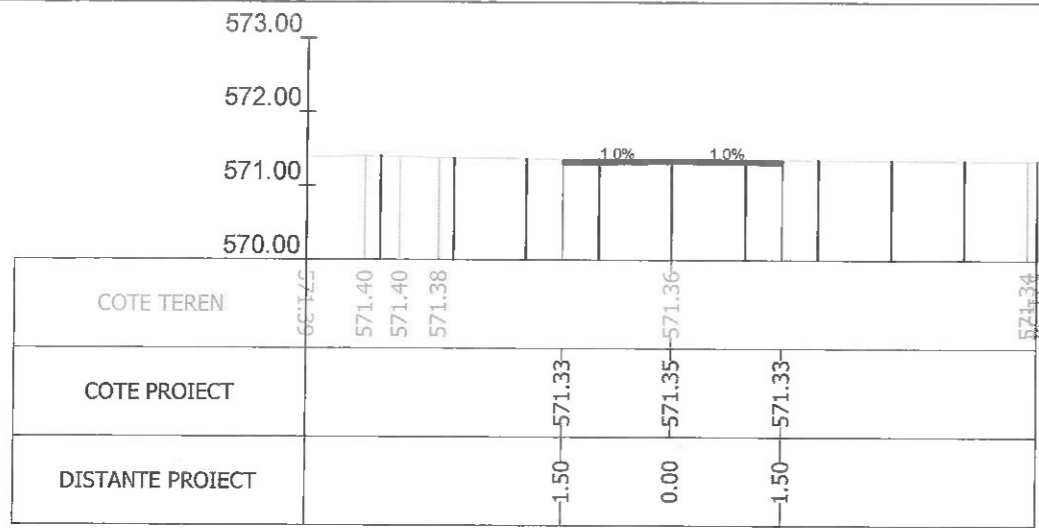

Sectiunea 277 - Km 3+950
Ax-Traseul 1

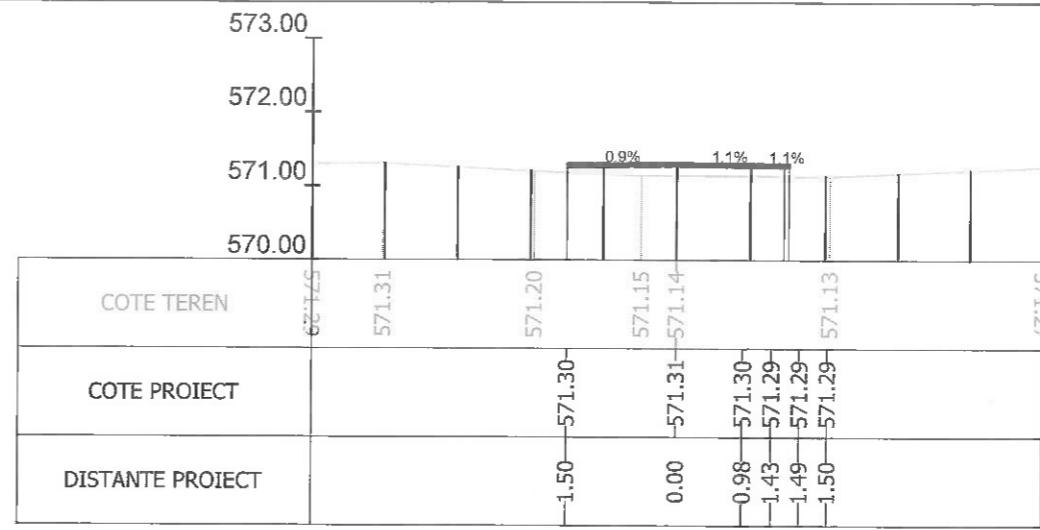

Sectiunea 278 - Km 3+952.863
Ax-Traseul 1

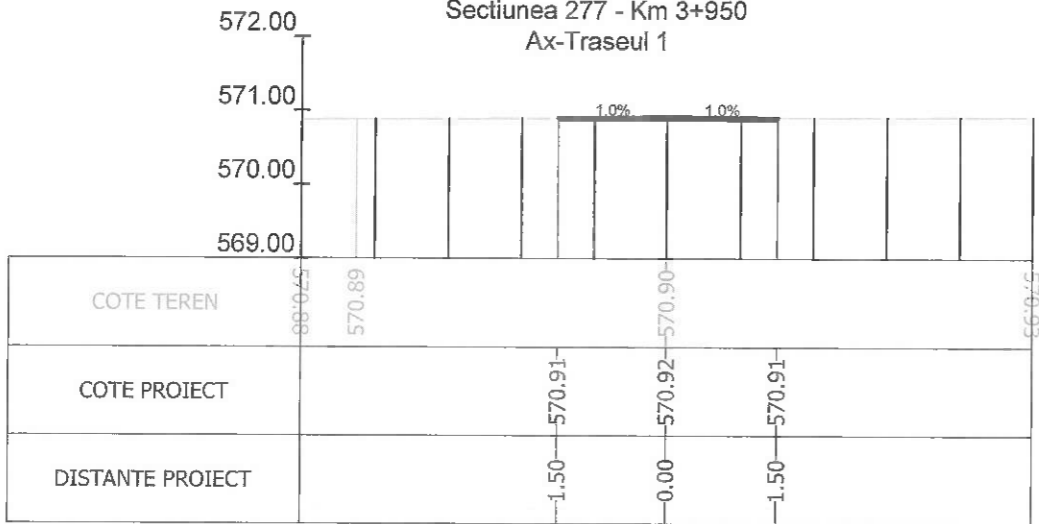

Sectiunea 279 - Km 3+975
Ax-Traseul 1

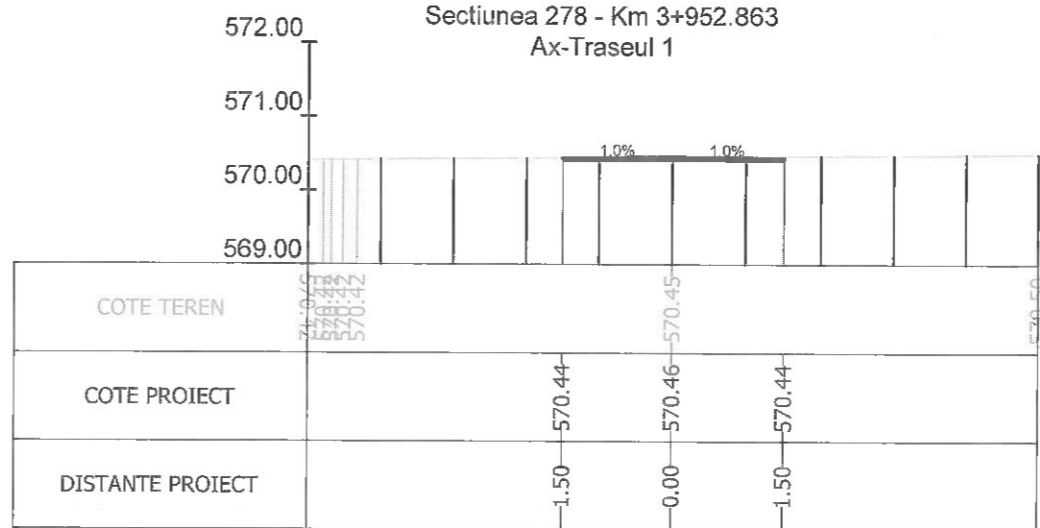

Sectiunea 280 - Km 4+000
Ax-Traseul 1

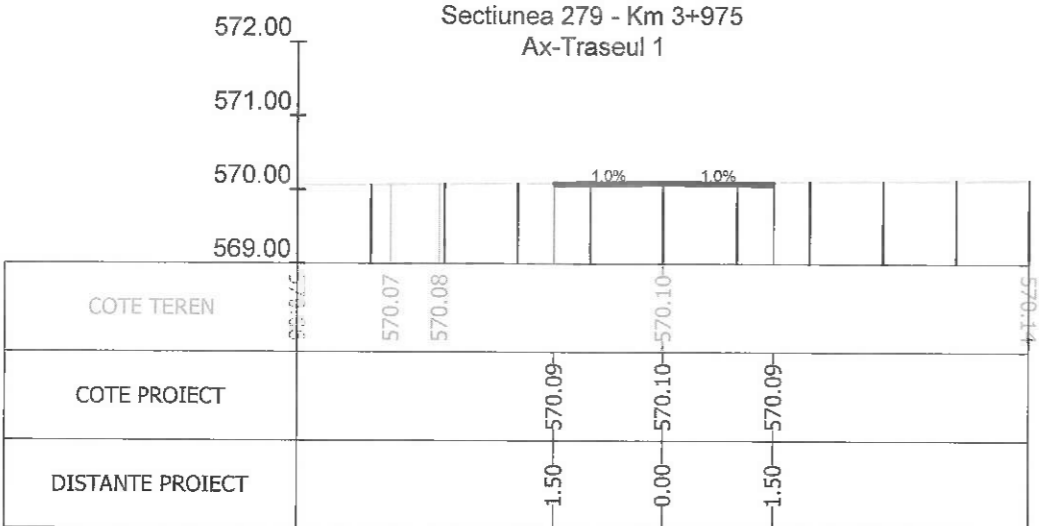

Sectiunea 281 - Km 4+025
Ax-Traseul 1

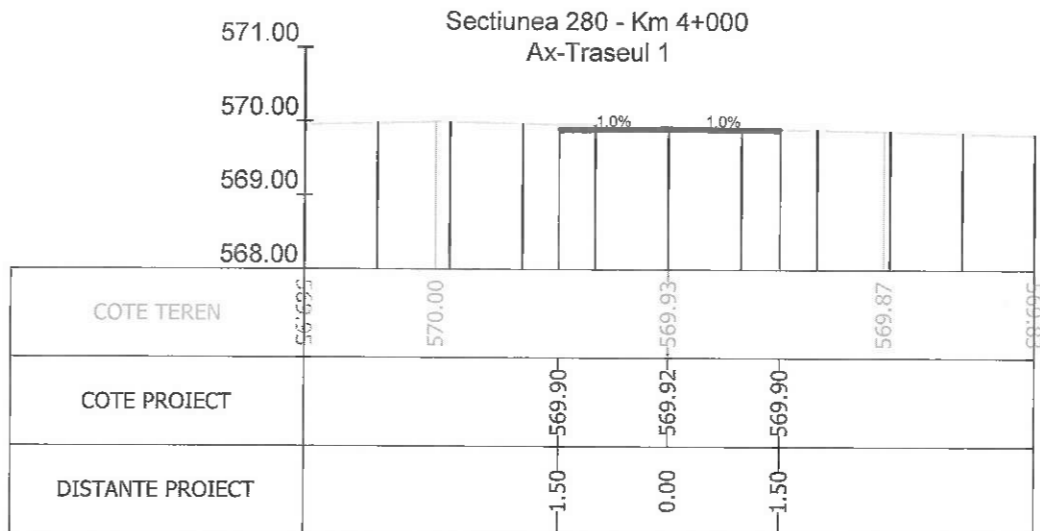

Sectiunea 282 - Km 4+050
Ax-Traseul 1

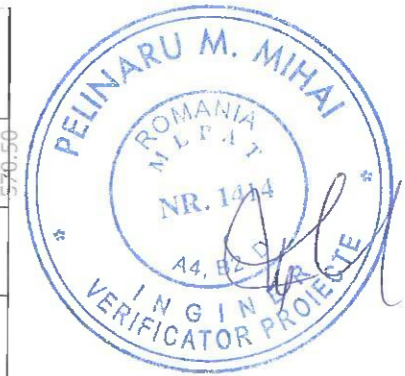

Index	Data	Observatii	Rev. 5
A			
		Beneficiar:	MUNICIPIUL BRASOV Bulevardul Eroilor 8, Brasov 500007
		Nr. proiect	73 / 2020
		Titlu proiect:	INFRASTRUCTURA INTEGRATA PENTRU CICLISM SI TRAFIC PIETONAL CU FACILITATI COMPLEMENTARE - TRASEUL 1
		Faza	P.T.
		Titlu plansa:	PROFILURI TRANSVERSALE TIP
		Nr. plansa	PTC 32
Sef Proiect	Ing. A. Buta	Scara	1:100
Proiectat	Ing. A. Buta	Data	07/2023
Desenat	Ing. S. Patroi		
Verificat			

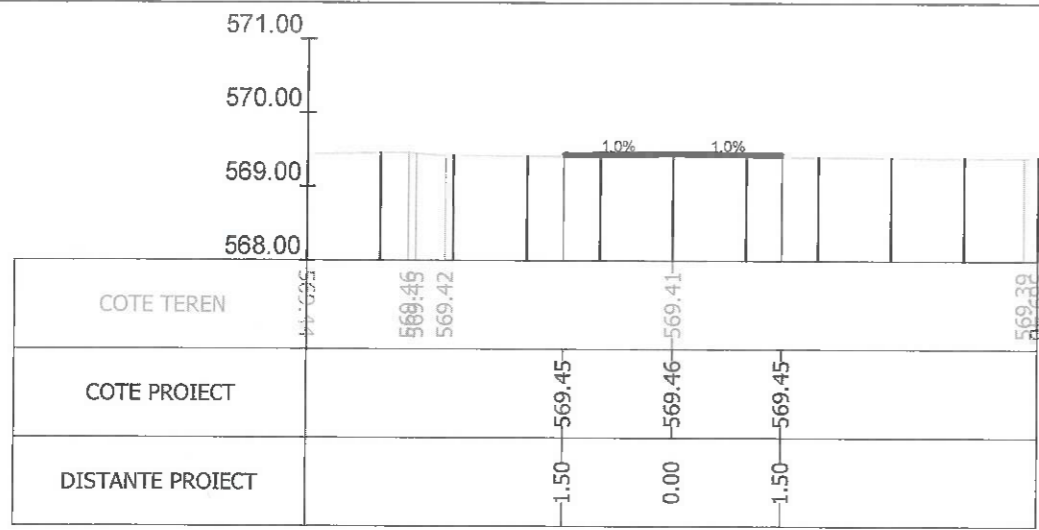

Sectiunea 283 - Km 4+075
Ax-Traseul 1

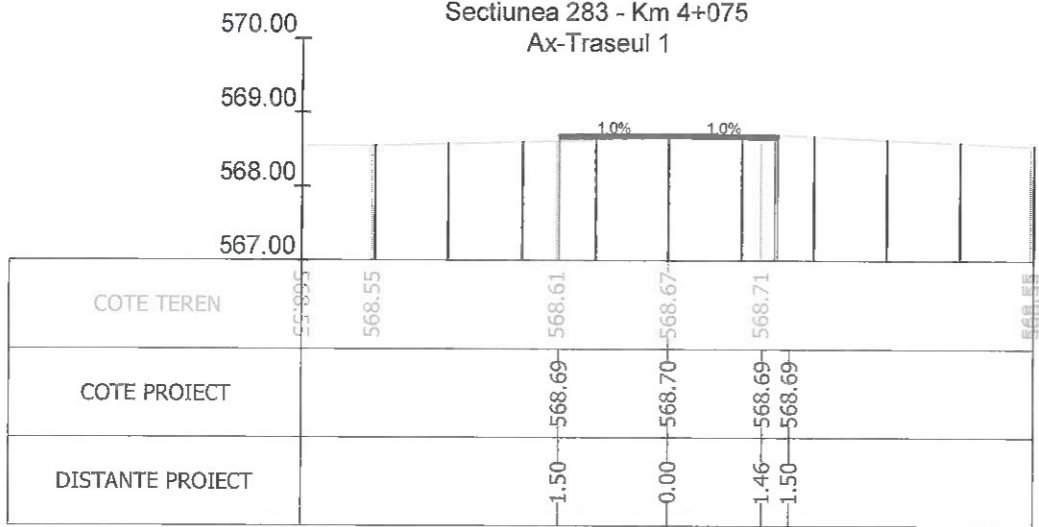

Sectiunea 285 - Km 4+120.026
Ax-Traseul 1

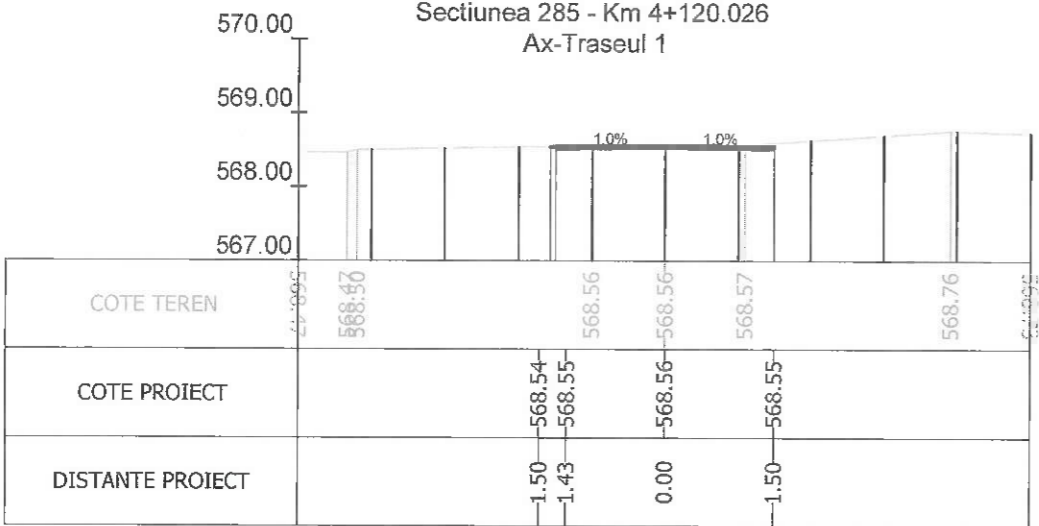

Sectiunea 287 - Km 4+129.883
Ax-Traseul 1

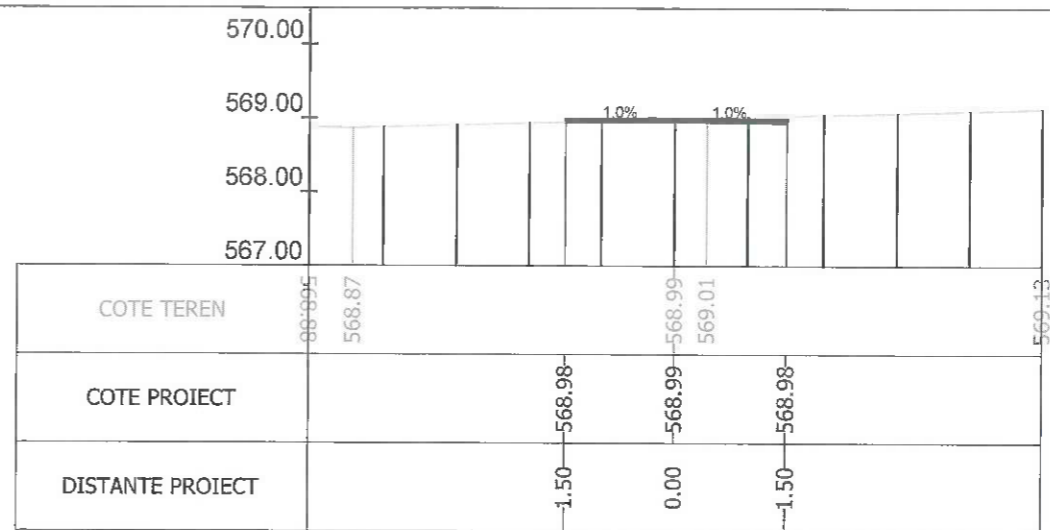

Sectiunea 284 - Km 4+100
Ax-Traseul 1

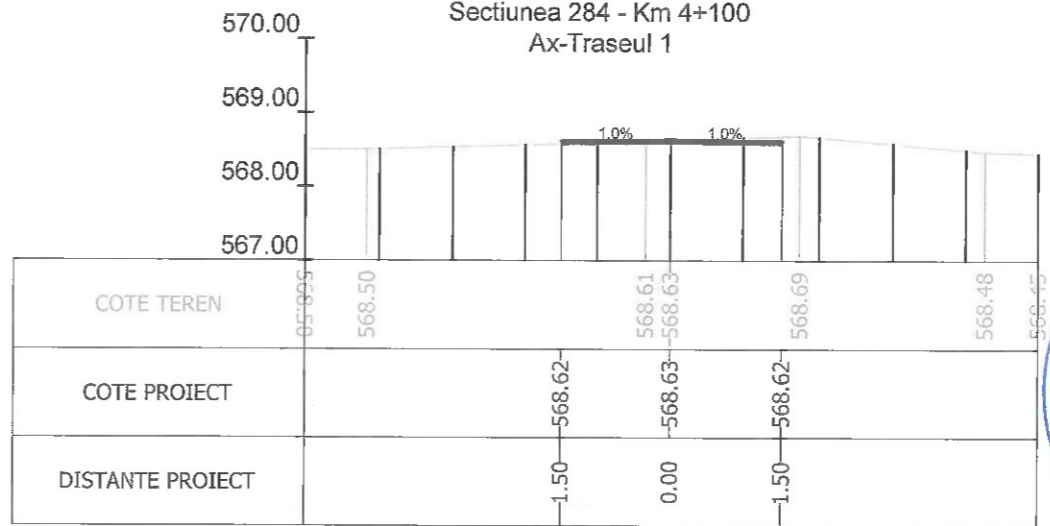

Sectiunea 286 - Km 4+125
Ax-Traseul 1

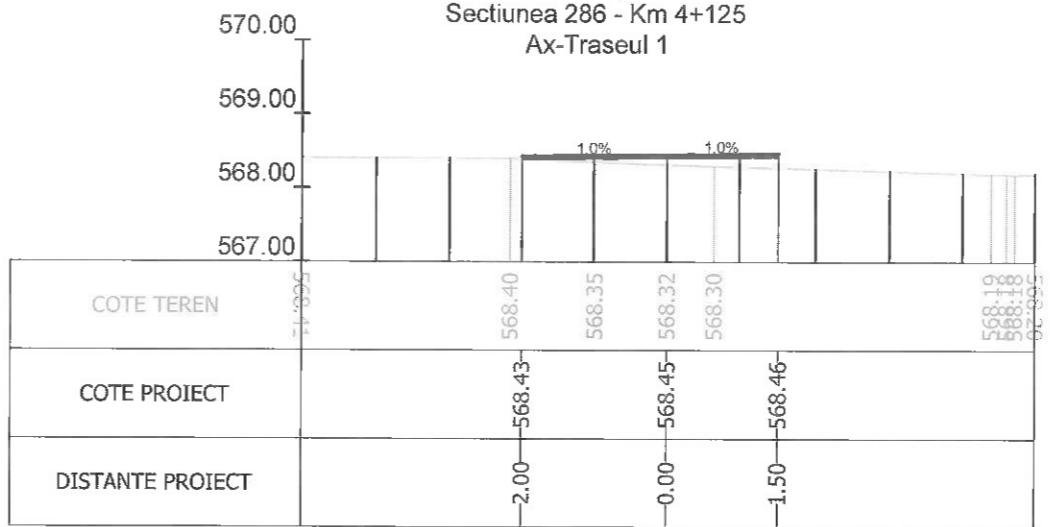

Sectiunea 288 - Km 4+137.725
Ax-Traseul 1



Index	Data	Observatii	Rev. 5
A			
		Beneficiar:	MUNICIPIUL BRASOV Bulevardul Eroilor 8, Brasov 500007
		Nr. proiect	73 / 2020
		Titlu proiect:	INFRASTRUCTURA INTEGRATA PENTRU CICLISM SI TRAFIC PIETONAL CU FACILITATI COMPLEMENTARE - TRASEUL 1
		Faza	P.T.
		Titlu plansa:	PROFILURI TRANSVERSALE TIP
		Nr. plansa	PTC 33
Sef Proiect	Ing. A. Buta	Scara	1:100
Proiectat	Ing. A. Buta	Data	07/2023
Desenat	Ing. S. Patroi		
Verificat			

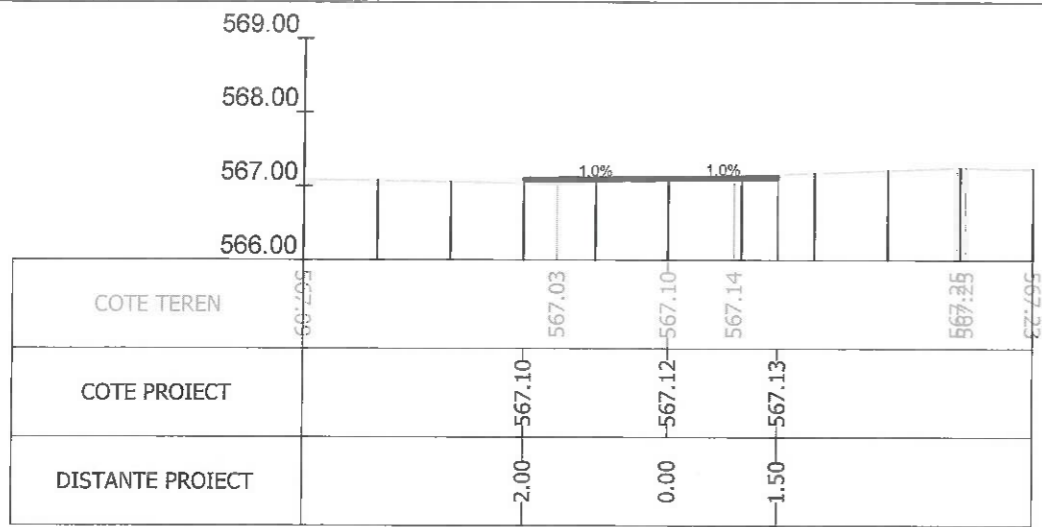

Sectiunea 301 - Km 4+275
Ax-Traseul 1

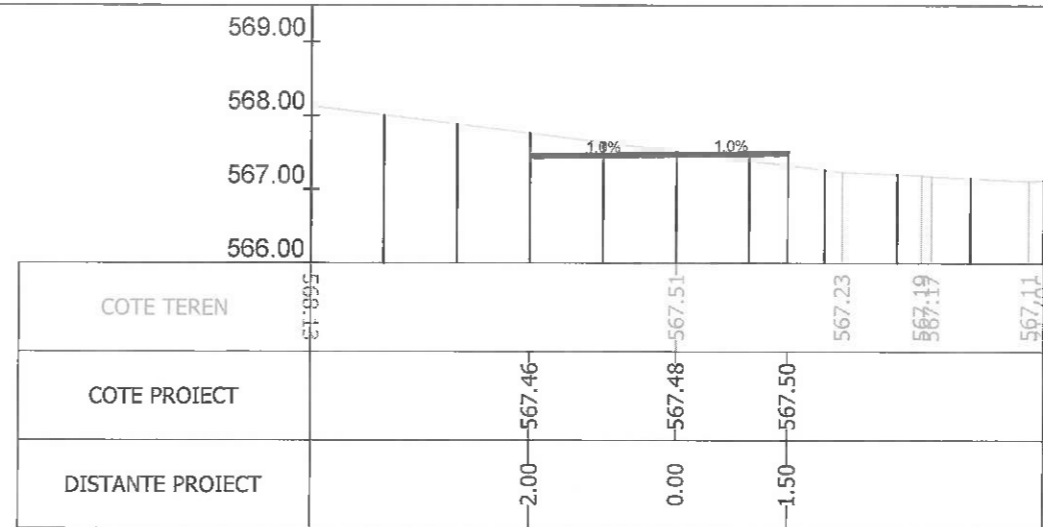

Sectiunea 302 - Km 4+300
Ax-Traseul 1

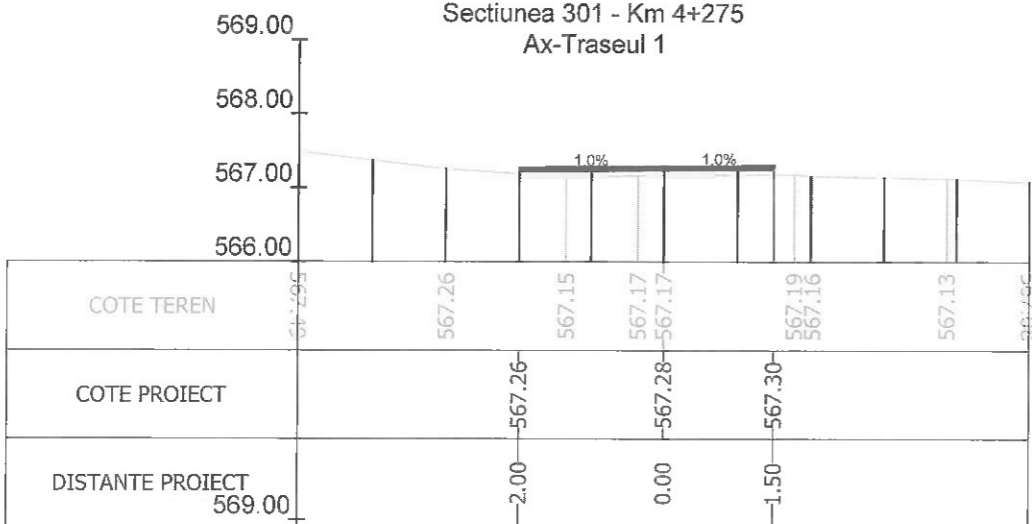

Sectiunea 303 - Km 4+312.532
Ax-Traseul 1

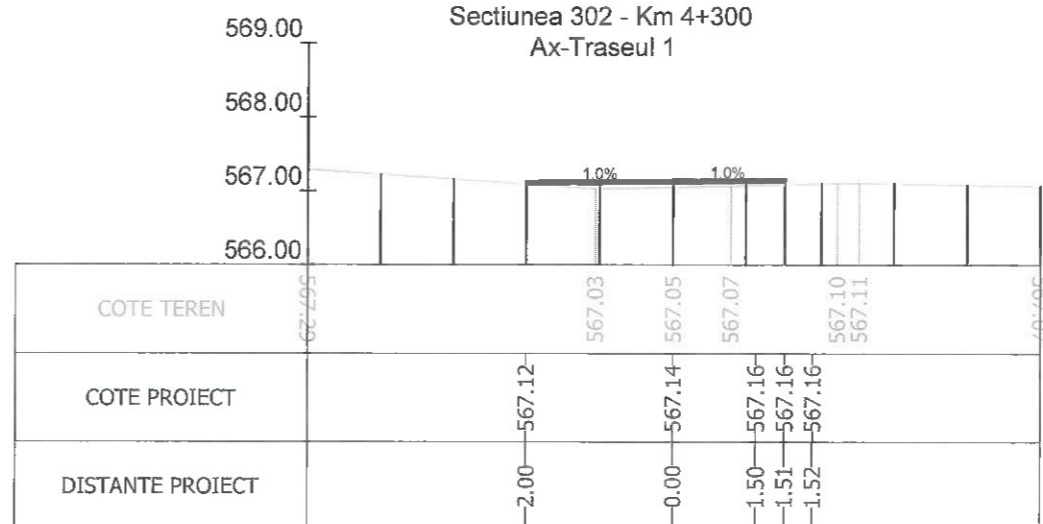

Sectiunea 304 - Km 4+316.717
Ax-Traseul 1

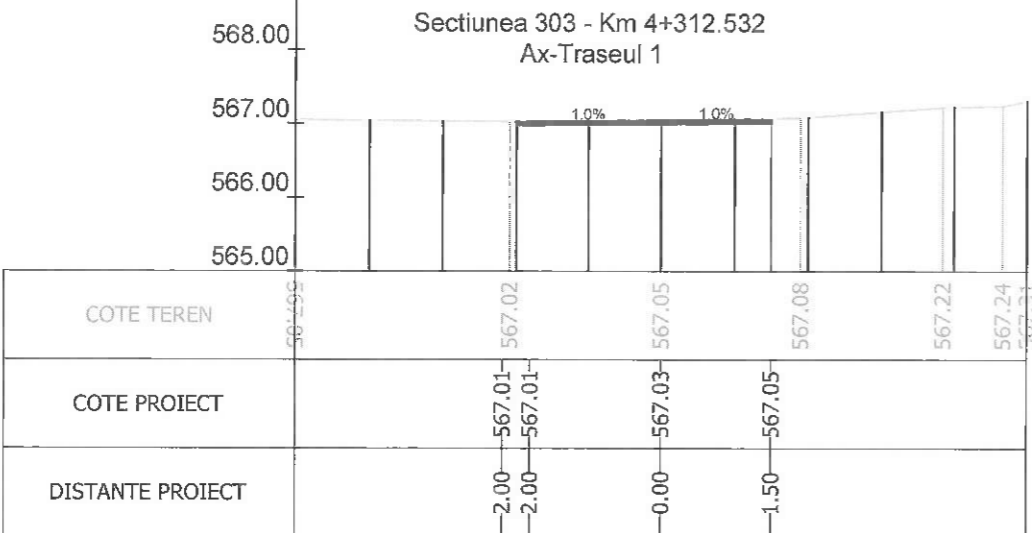

Sectiunea 320 - Km 4+395.879
Ax-Traseul 1

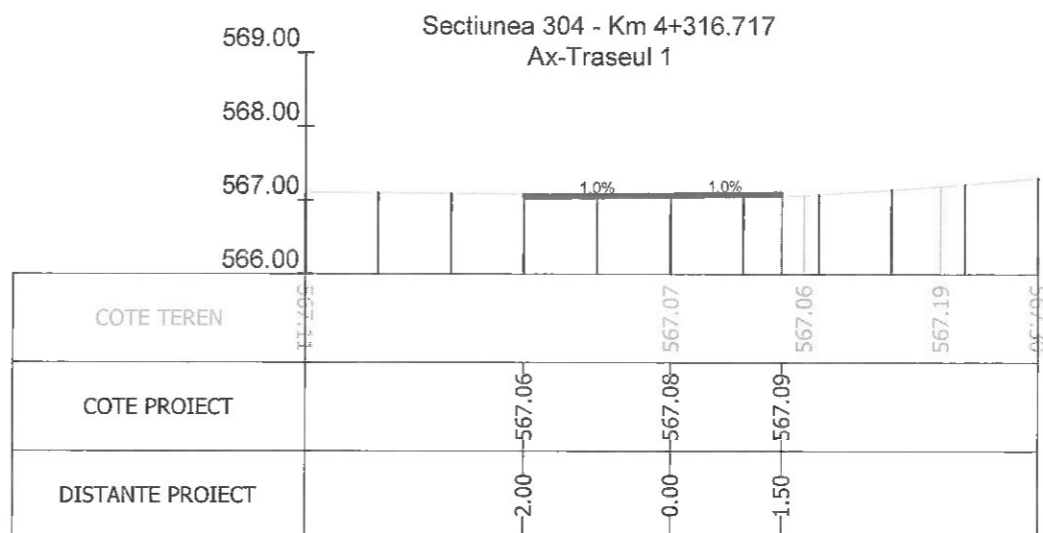

Sectiunea 321 - Km 4+400
Ax-Traseul 1



Index	Data	Observatii	Rev. 5
A			
		Beneficiar:	MUNICIPIUL BRASOV Bulevardul Eroilor 8, Brasov 500007
		Titlu proiect:	INFRASTRUCTURA INTEGRATA PENTRU CICLISM SI TRAFIC PIETONAL CU FACILITATI COMPLEMENTARE - TRASEUL 1
		Titlu planşa:	PROFILURI TRANSVERSALE TIP
Sef Proiect	Ing. A. Buta	Scara	Nr. proiect 73 / 2020
Proiectat	Ing. A. Buta	1:100	Faza P.T.
Desenat	Ing. S. Patroi	Data	Nr. planşa PTC 36
Verificat		07/2023	

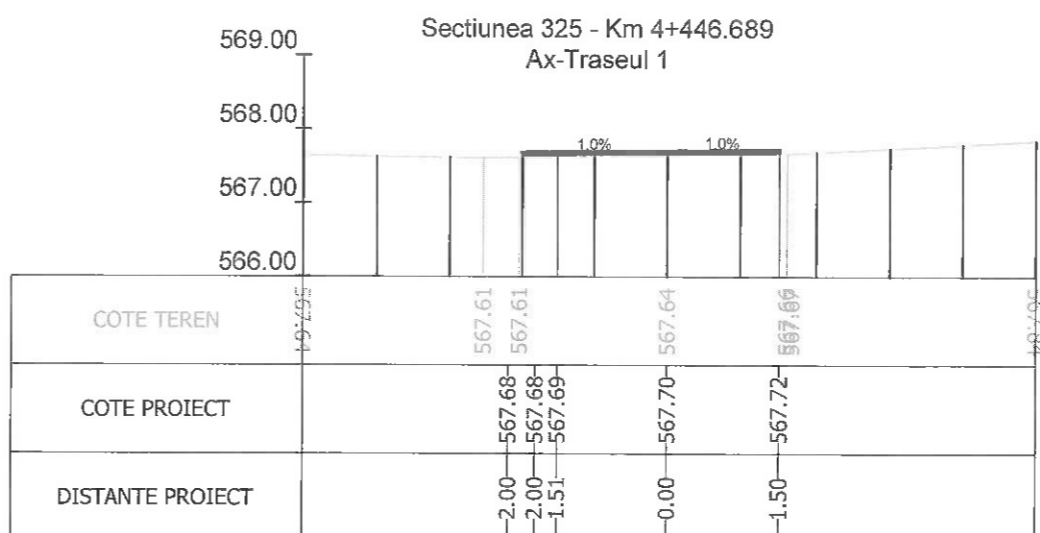
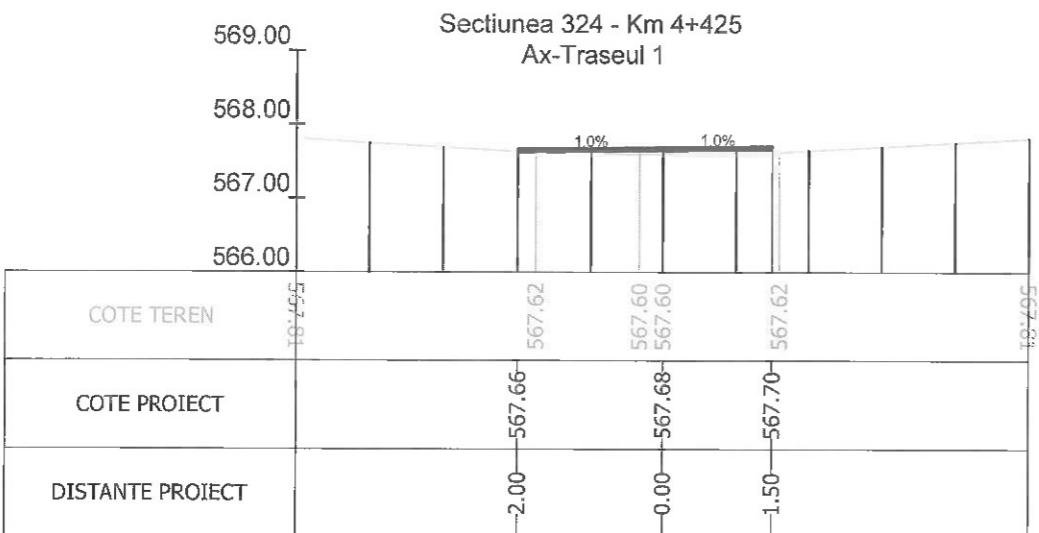
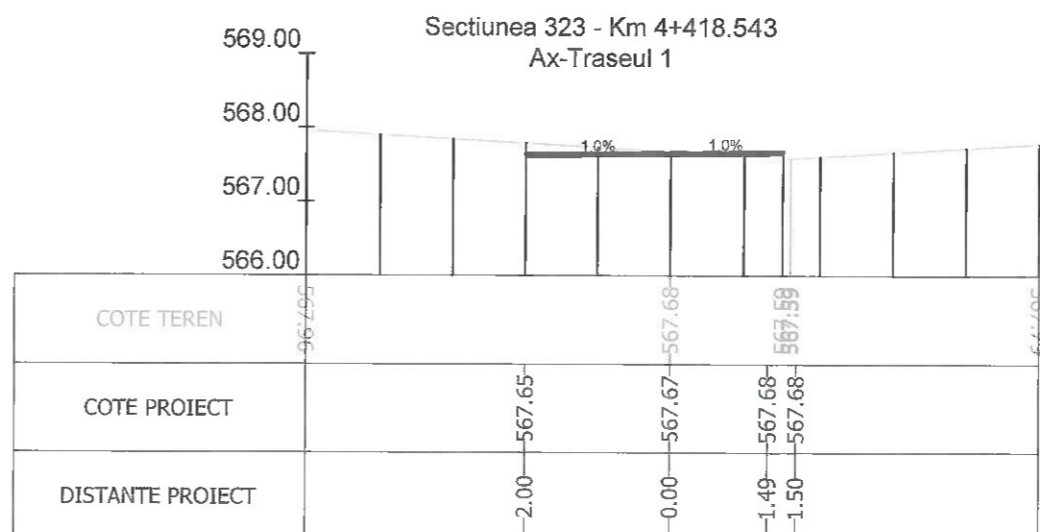
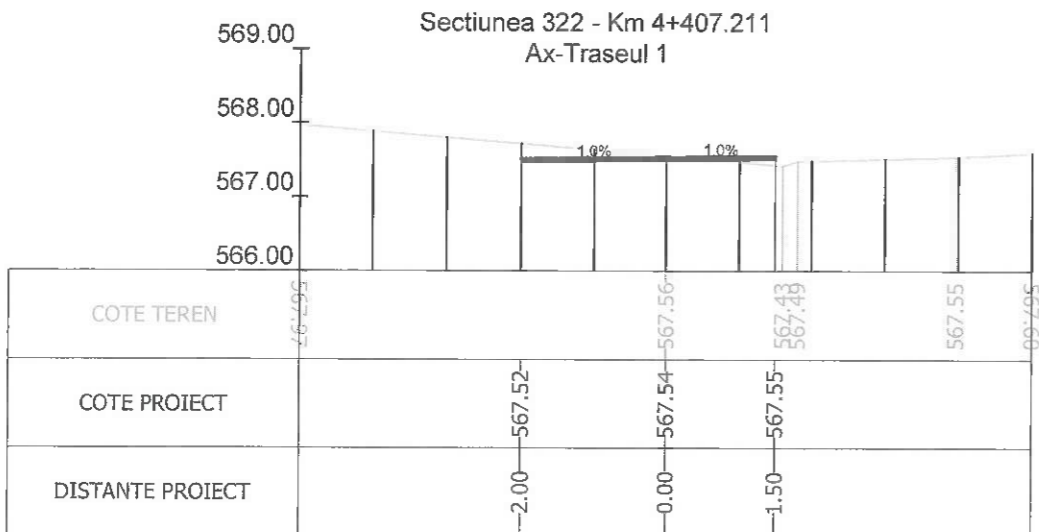
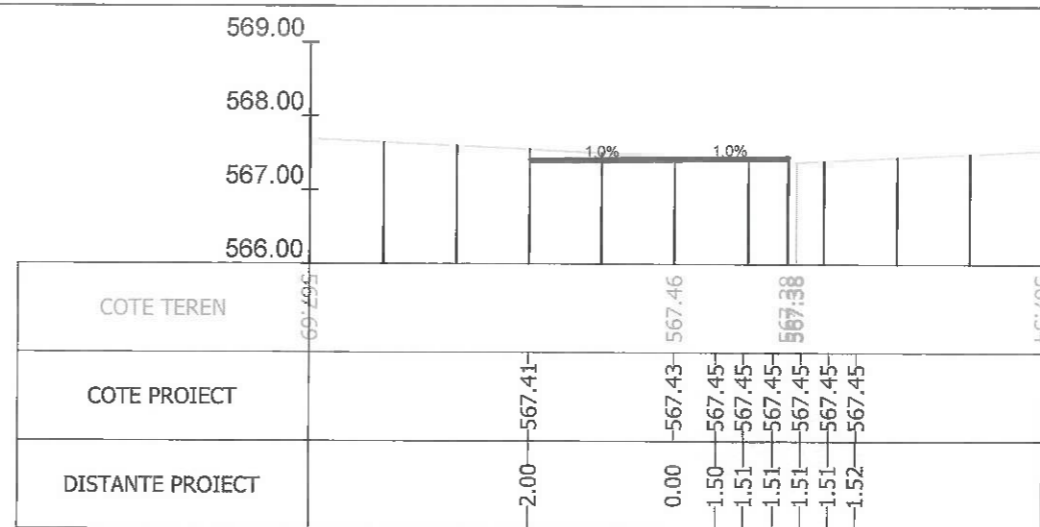
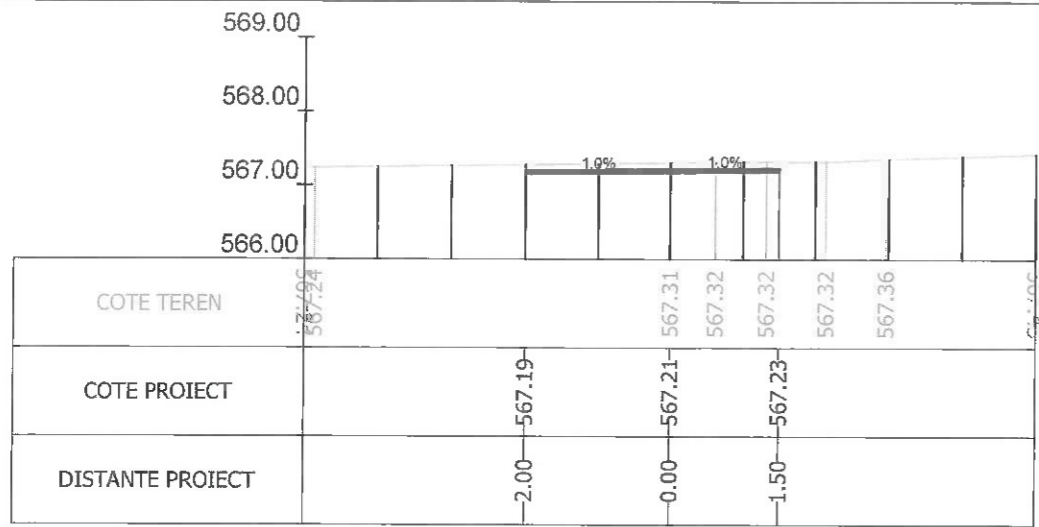

Sectiunea 326 - Km 4+450
Ax-Traseul 1

Sectiunea 327 - Km 4+453.785
Ax-Traseul 1

Index	Data	Observatii		Rev. 5
A				
		Beneficiar: MUNICIPIUL BRASOV Bulevardul Eroilor 8, Brasov 500007		Nr. proiect 73 / 2020
Sef Proiect Ing. A. Buta Proiectat Ing. A. Buta Desenat Ing. S. Patroi Verificat		Titlu proiect: INFRASTRUCTURA INTEGRATA PENTRU CICLISM SI TRAFIC PIETONAL CU FACILITATI COMPLEMENTARE - TRASEUL 1 Titlu planse: PROFILURI TRANSVERSALE TIP		Faza P.T. Nr. planse PTC 37
		Scara 1:100 Data 07/2023		

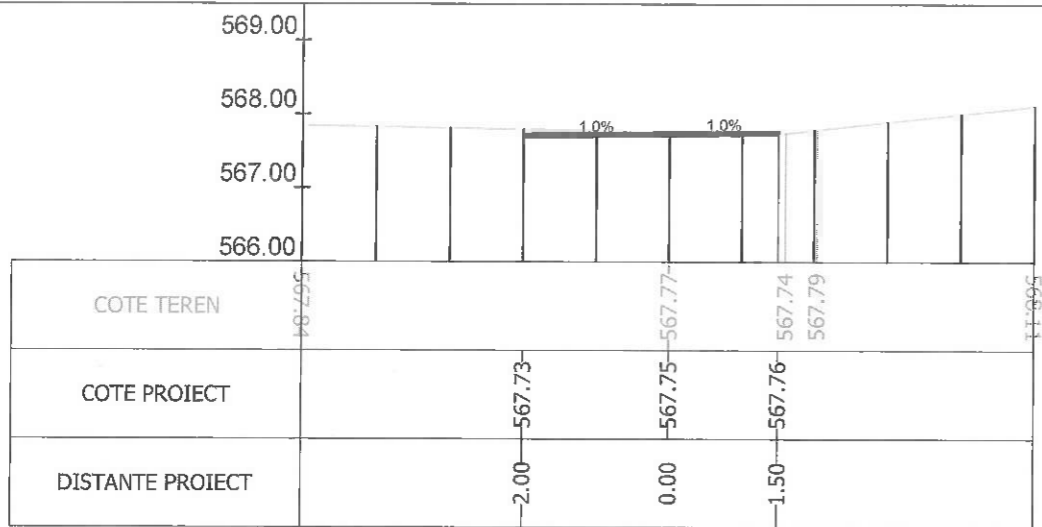

Sectiunea 334 - Km 4+500
Ax-Traseul 1

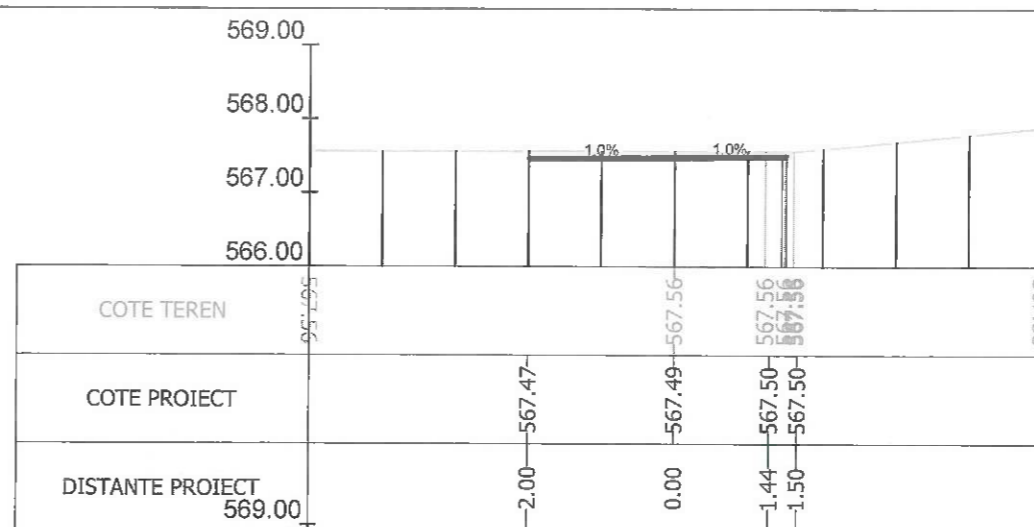

Sectiunea 335 - Km 4+517.333
Ax-Traseul 1

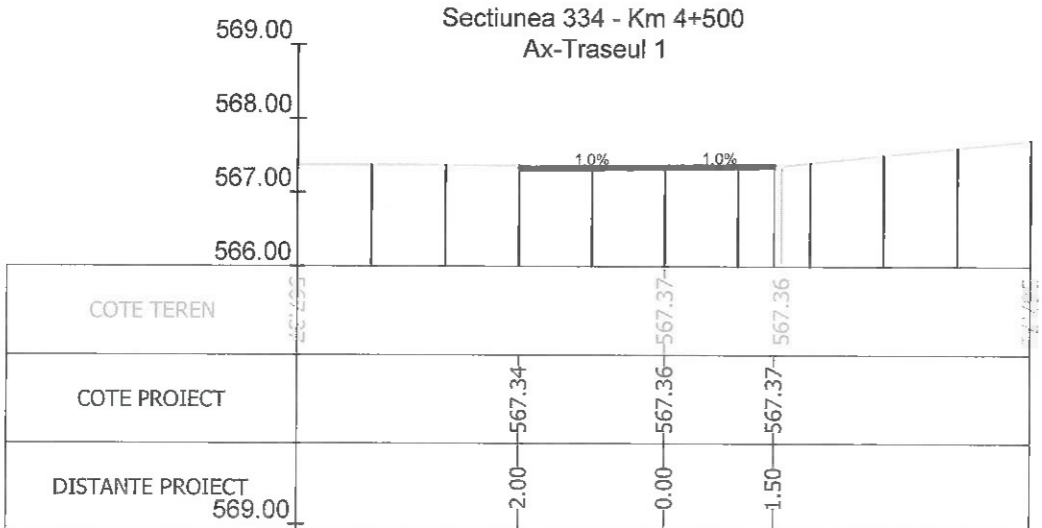

Sectiunea 336 - Km 4+525
Ax-Traseul 1

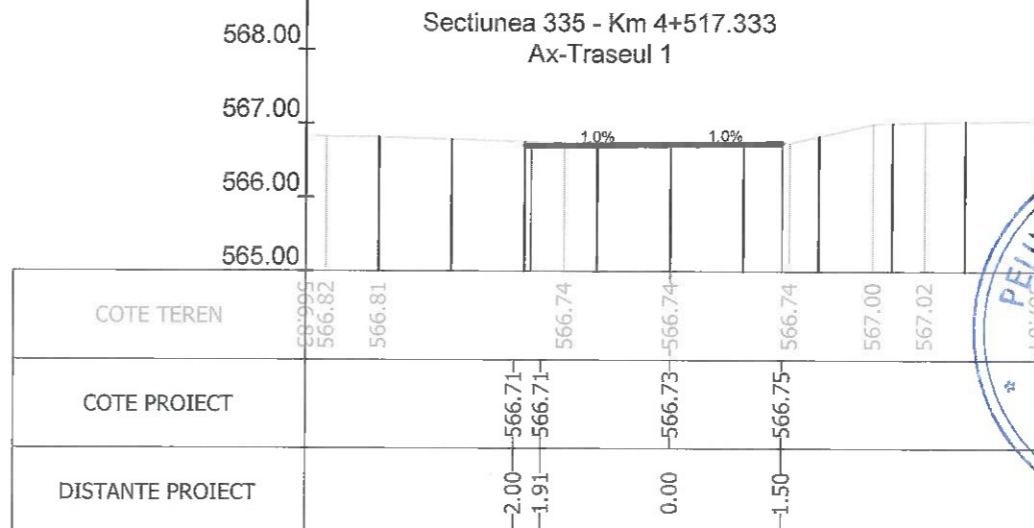

Sectiunea 337 - Km 4+549.370
Ax-Traseul 1

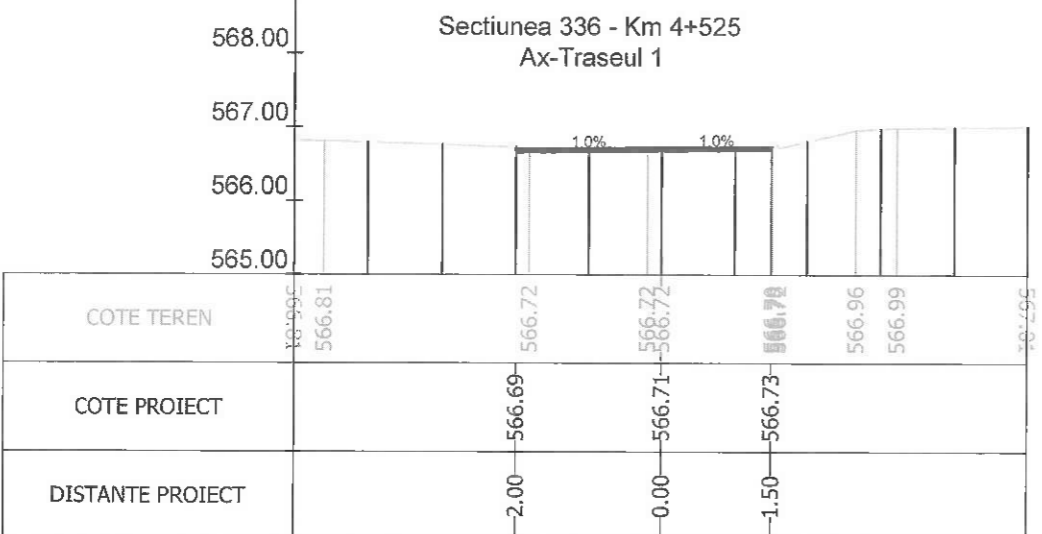

Sectiunea 338 - Km 4+550
Ax-Traseul 1

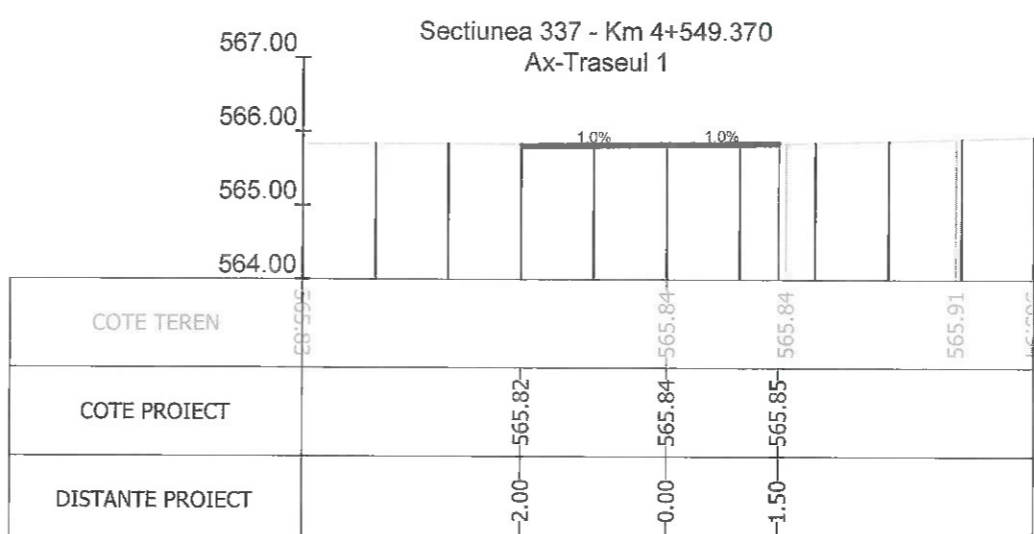

Sectiunea 339 - Km 4+575
Ax-Traseul 1



Index	Data	Observatii	Rev. 5
A			
		Beneficiar:	MUNICIPIUL BRASOV Bulevardul Eroilor 8, Brasov 500007
		Titlu proiect:	INFRASTRUCTURA INTEGRATA PENTRU CICLISM SI TRAFIC PIETONAL CU FACILITATI COMPLEMENTARE - TRASEUL 1
		Titlu plansa:	PROFILURI TRANSVERSALE TIP
		Nr. proiect	73 / 2020
		Nr. plansa	PTC 39
Sef Proiect	Ing. A. Buta	Scara	1:100
Proiectat	Ing. A. Buta	Data	07/2023
Desenat	Ing. S. Patroi		
Verificat			

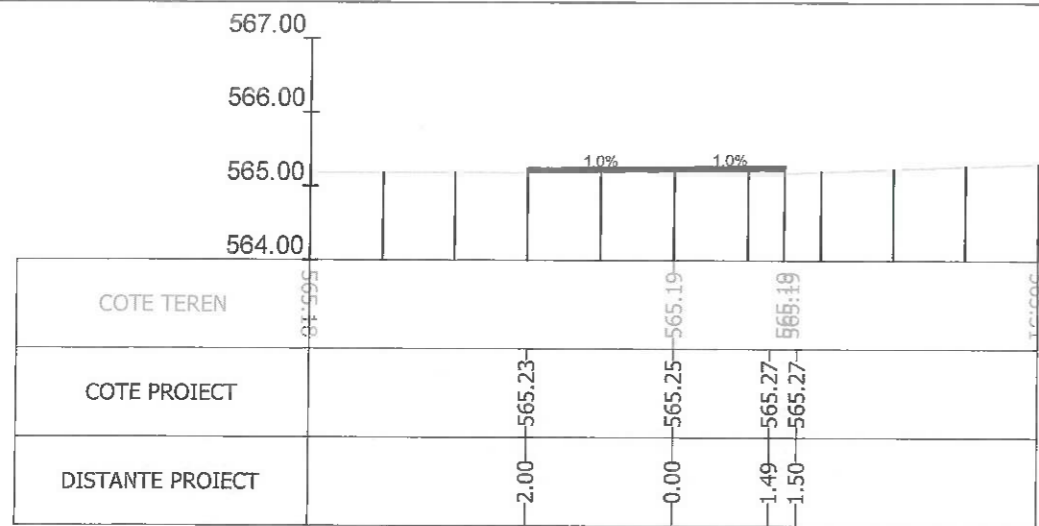

Sectiunea 340 - Km 4+593.592
Ax-Traseul 1

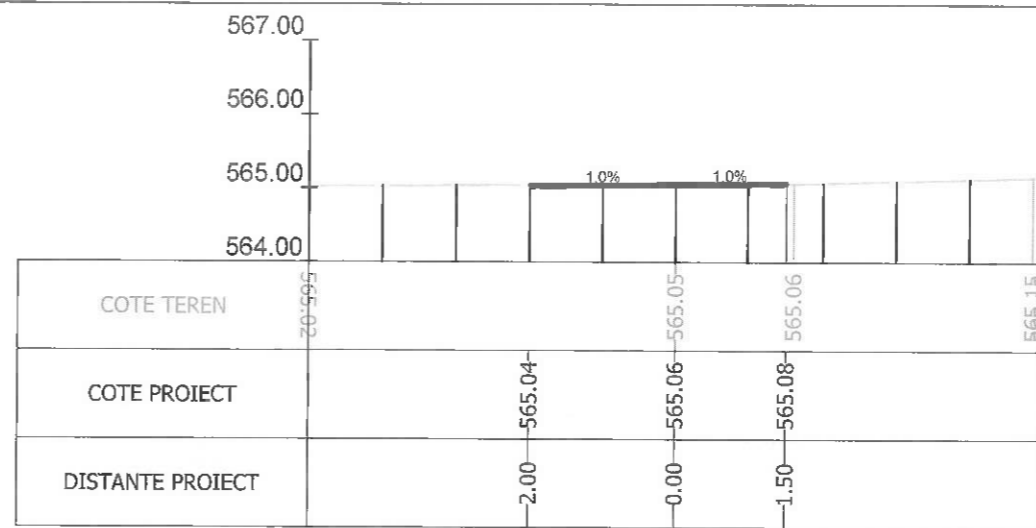

Sectiunea 341 - Km 4+600
Ax-Traseul 1

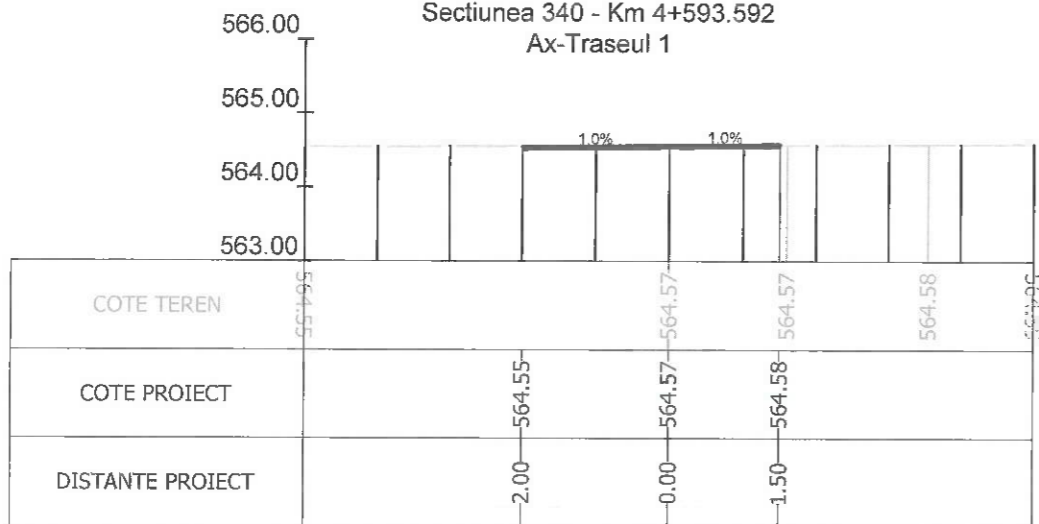

Sectiunea 342 - Km 4+625
Ax-Traseul 1

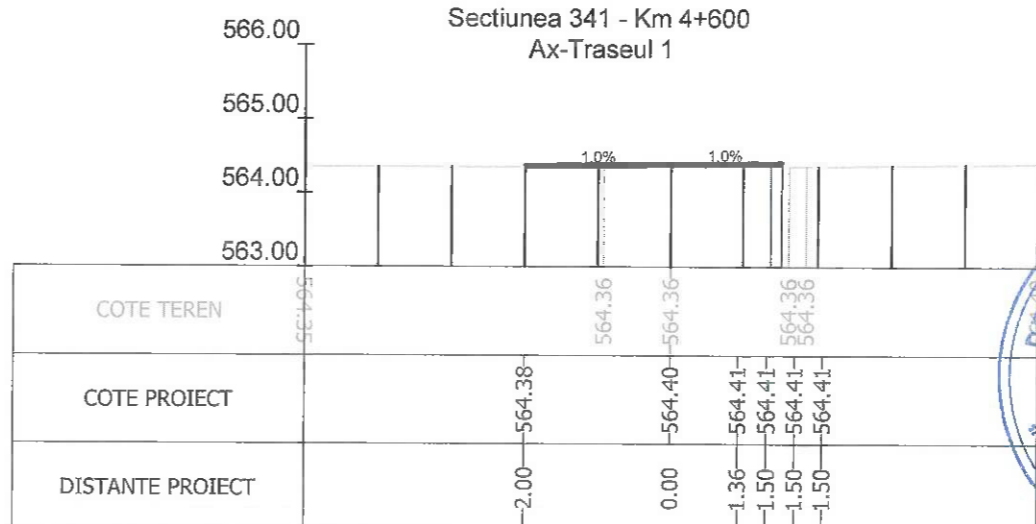

Sectiunea 343 - Km 4+635.938
Ax-Traseul 1

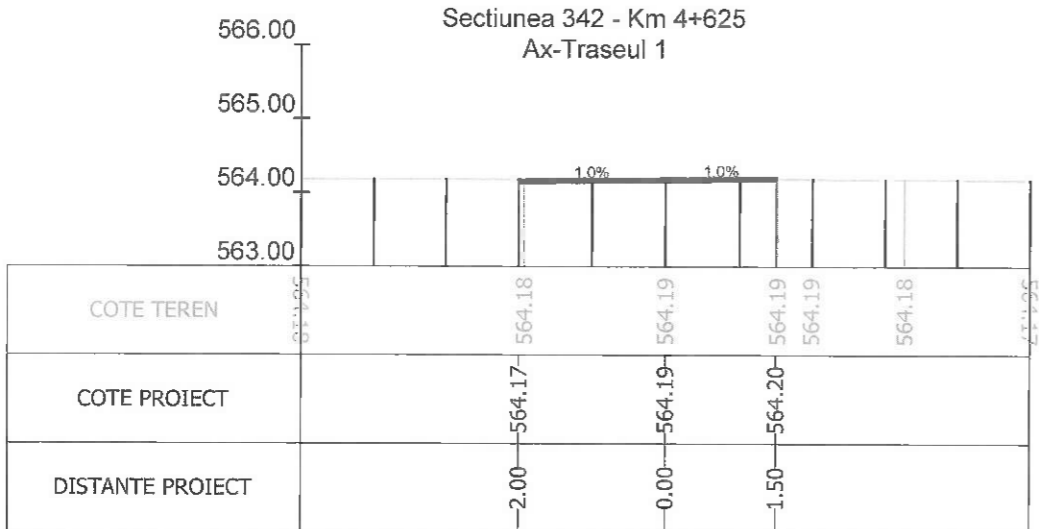

Sectiunea 344 - Km 4+650
Ax-Traseul 1

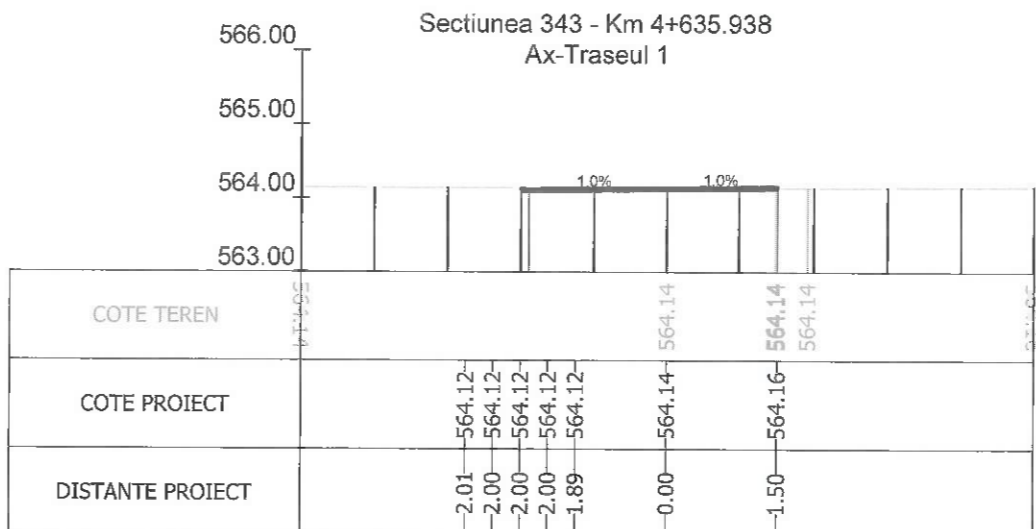

Sectiunea 345 - Km 4+653.858
Ax-Traseul 1



Index	Data	Observatii	Rev. 5
A			
		Beneficiar:	MUNICIPIUL BRASOV Bulevardul Eroilor 8, Brasov 500007
		Titlu proiect:	INFRASTRUCTURA INTEGRATA PENTRU CICLISM SI TRAFIC PIETONAL CU FACILITATI COMPLEMENTARE - TRASEUL 1
Sef Proiect	Ing. A. Buta	Scara	Nr. proiect 73 / 2020
Proiectat	Ing. A. Buta	1:100	Faza P.T.
Desenat	Ing. S. Patroi	Data	Nr. plansa PTC 40
Verificat		07/2023	
		Titlu plansa: PROFILURI TRANSVERSALE TIP	

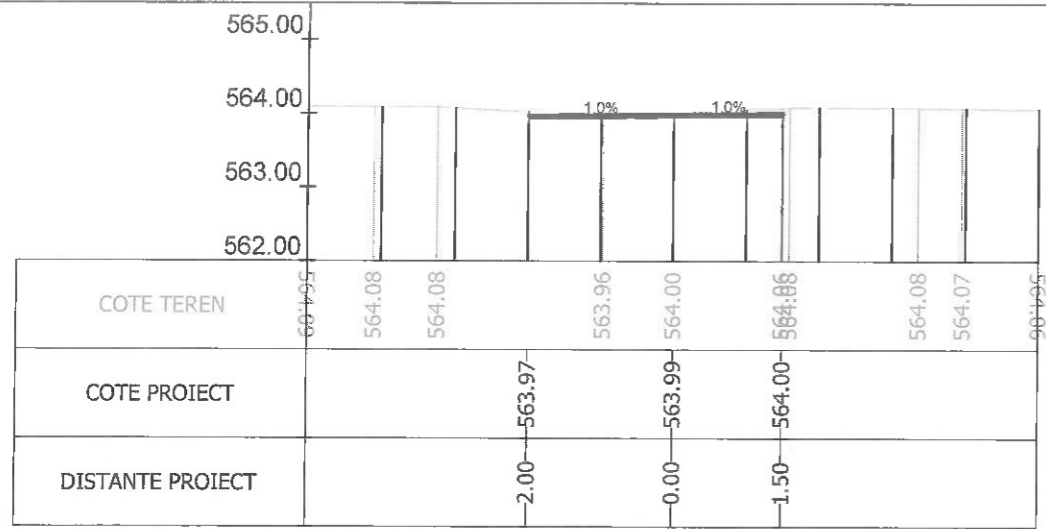

Sectiunea 346 - Km 4+666.984
Ax-Traseul 1

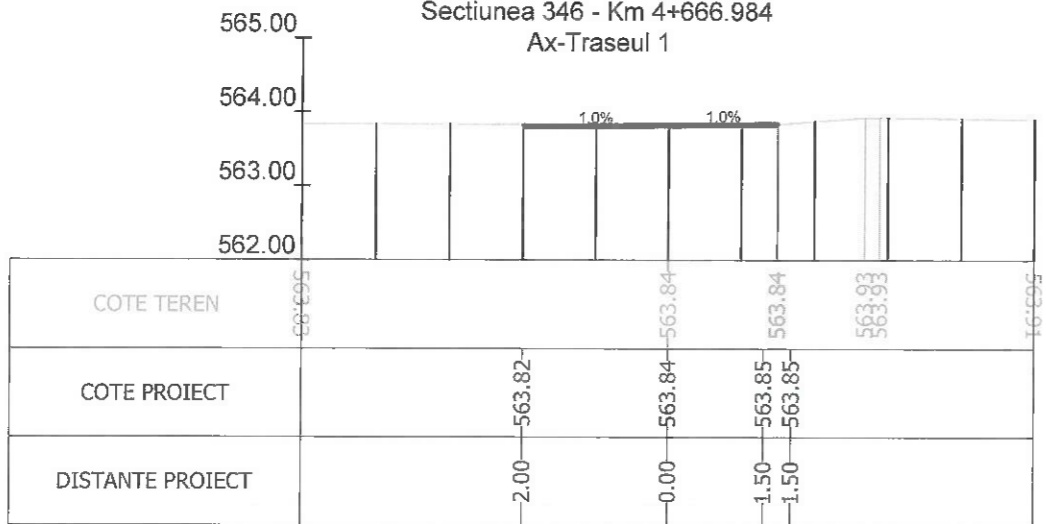

Sectiunea 347 - Km 4+675
Ax-Traseul 1

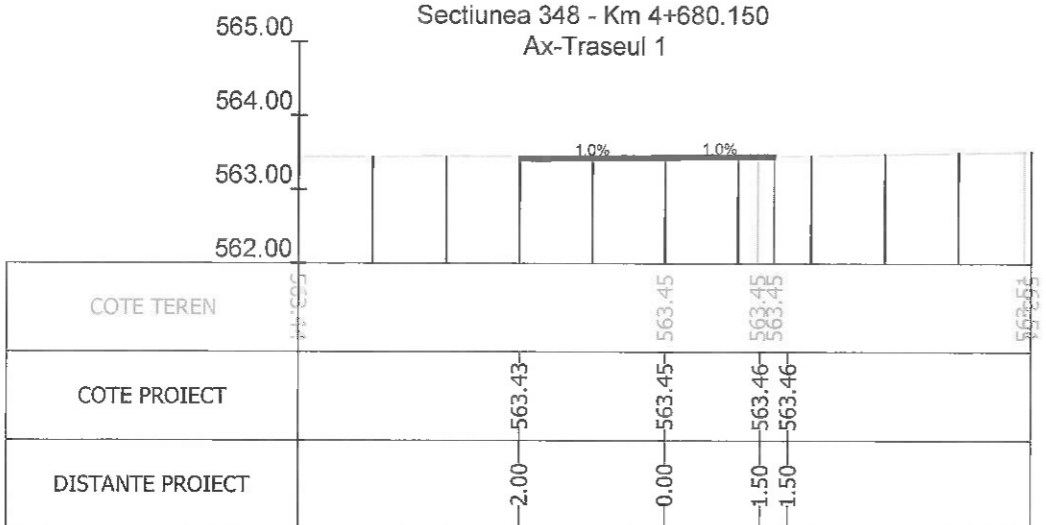

Sectiunea 348 - Km 4+680.150
Ax-Traseul 1

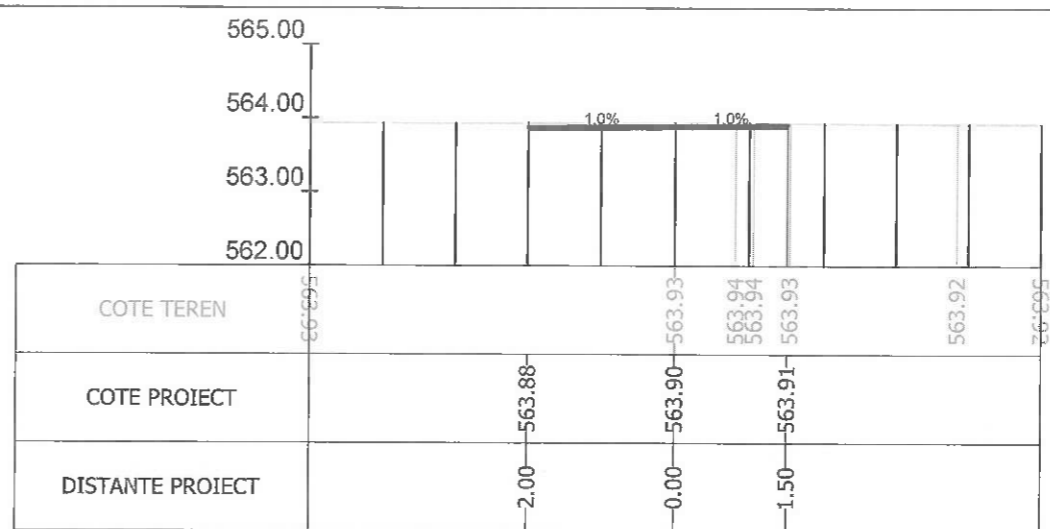

Sectiunea 349 - Km 4+700
Ax-Traseul 1

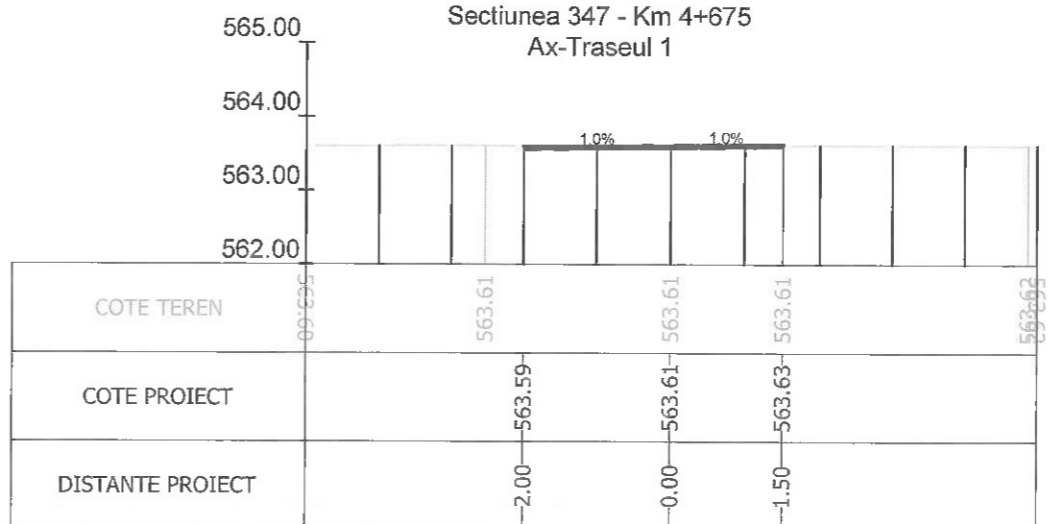

Sectiunea 351 - Km 4+725
Ax-Traseul 1

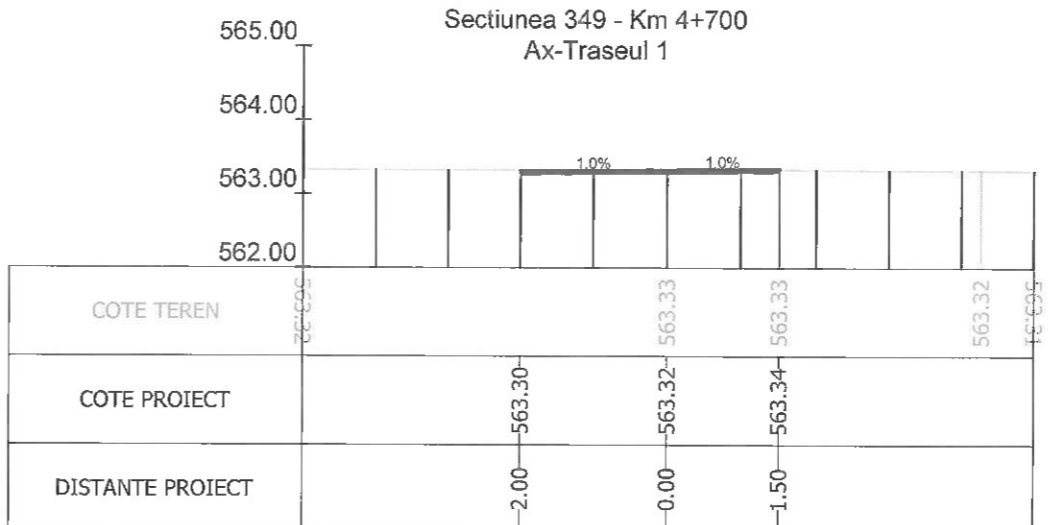

Index	Data	Observatii	Rev. 5
A			
		Beneficiar:	MUNICIPIUL BRASOV Bulevardul Eroilor 8, Brasov 500007
		Titlu proiect:	INFRASTRUCTURA INTEGRATA PENTRU CICLISM SI TRAFIC PIETONAL CU FACILITATI COMPLEMENTARE - TRASEUL 1
		Titlu planse:	PROFILURI TRANSVERSALE TIP
Sef Proiect	Ing. A. Buta	Scara	Nr. proiect 73 / 2020
Proiectat	Ing. A. Buta	1:100	Faza P.T.
Desenat	Ing. S. Patroi	Data	Nr. planse PTC 41
Verificat		07/2023	

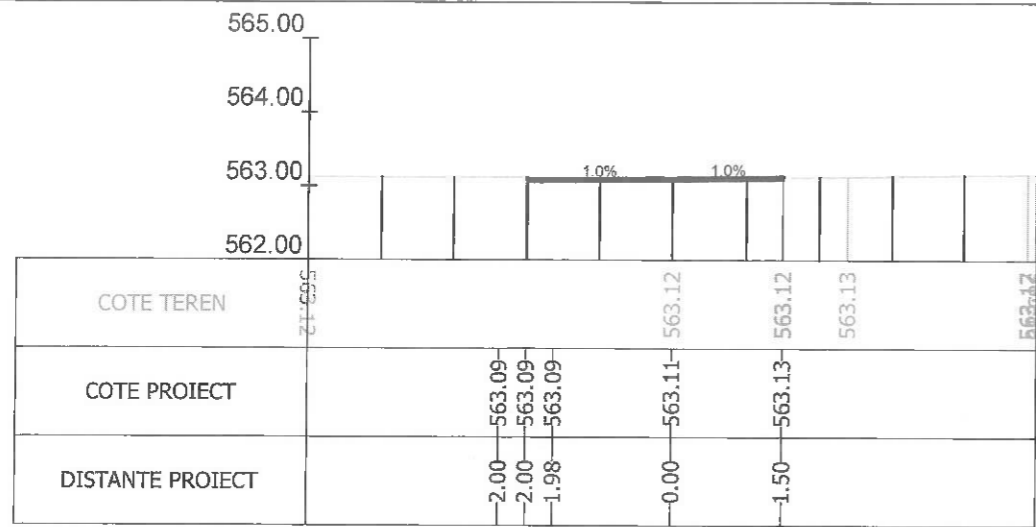

Sectiunea 352 - Km 4+743.422
Ax-Traseul 1

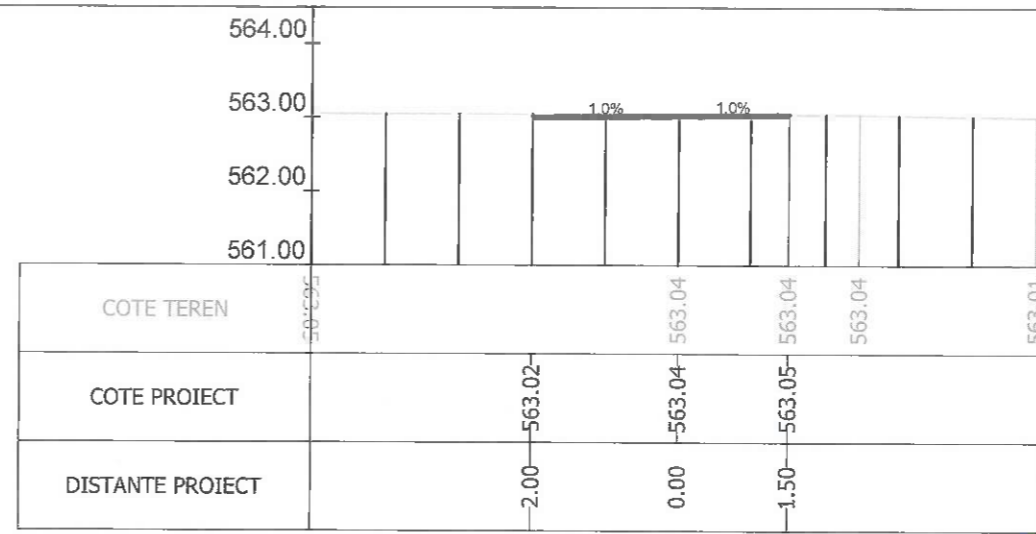

Sectiunea 353 - Km 4+750
Ax-Traseul 1

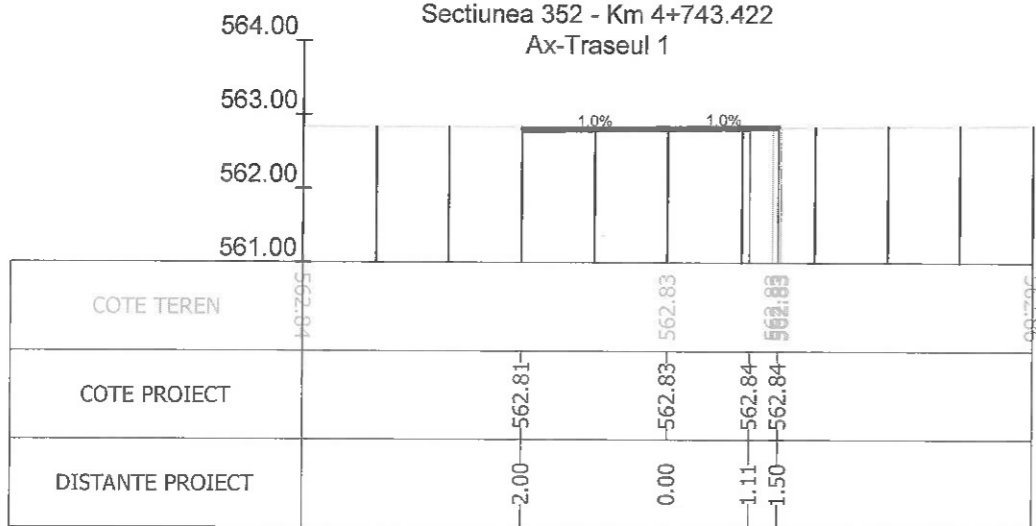

Sectiunea 354 - Km 4+767.994
Ax-Traseul 1

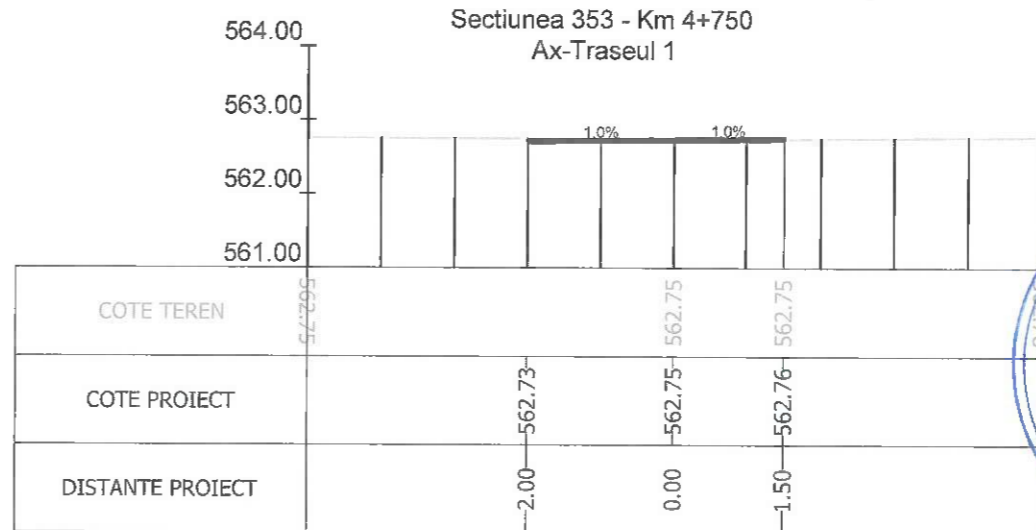

Sectiunea 355 - Km 4+775
Ax-Traseul 1

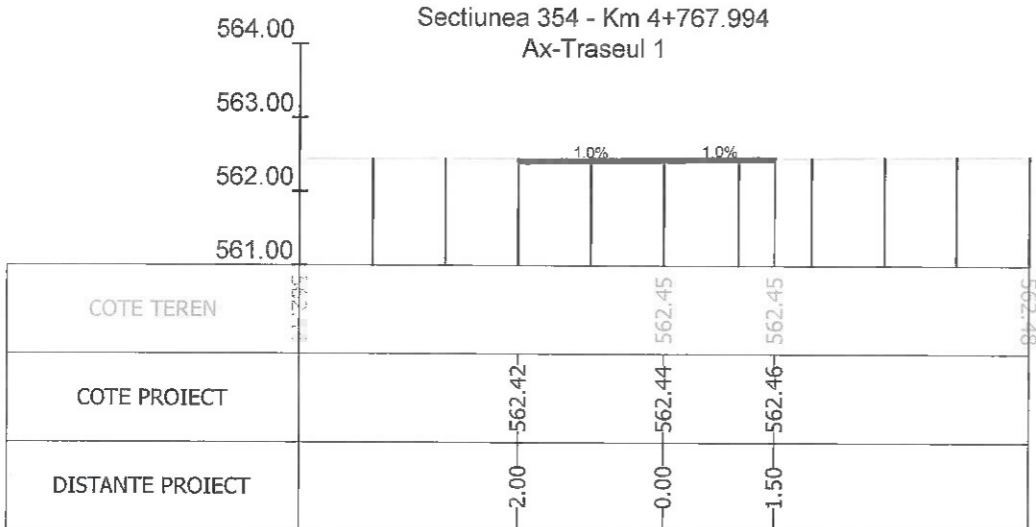

Sectiunea 356 - Km 4+800
Ax-Traseul 1

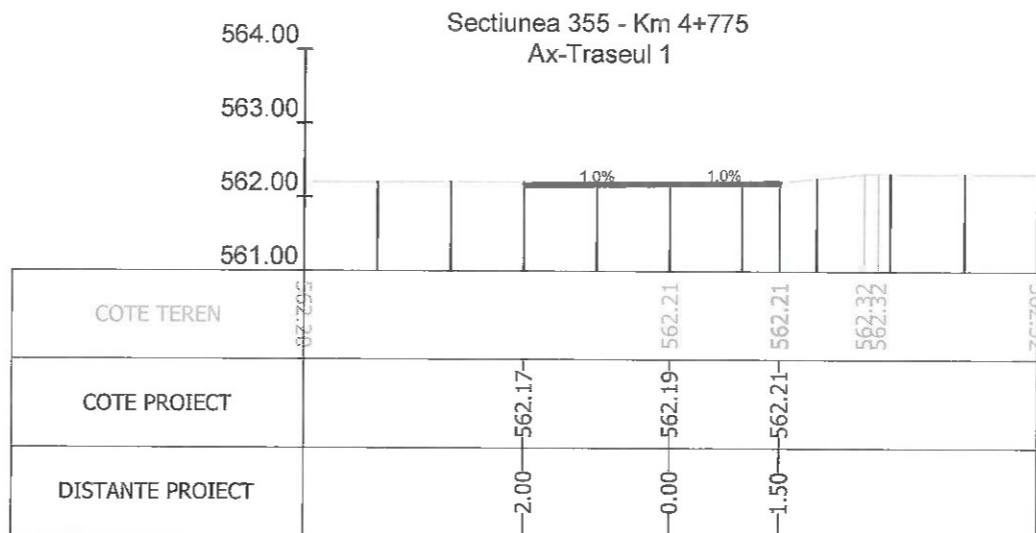

Sectiunea 357 - Km 4+820.304
Ax-Traseul 1

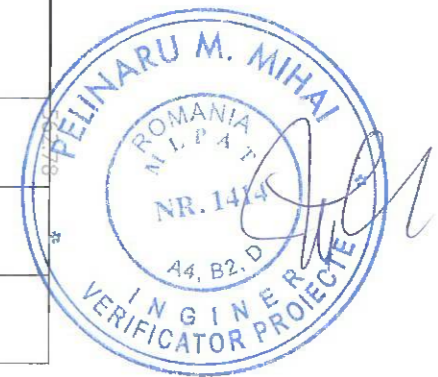

Index	Data	Observatii	Rev. 5
A			
			Beneficiar: MUNICIPIUL BRASOV Bulevardul Eroilor 8, Brasov 500007
			Nr. proiect: 73 / 2020
Sef Proiect: Ing. A. Buta Proiectat: Ing. A. Buta Desenat: Ing. S. Patroi Verificat:			Titlu proiect: INFRASTRUCTURA INTEGRATA PENTRU CICLISM SI TRAFIC PIETONAL CU FACILITATI COMPLEMENTARE - TRASEUL 1 Faza P.T. Titlu plansa: PROFILURI TRANSVERSALE TIP Nr. plansa PTC 42
Scara: 1:100			
Data: 07/2023			

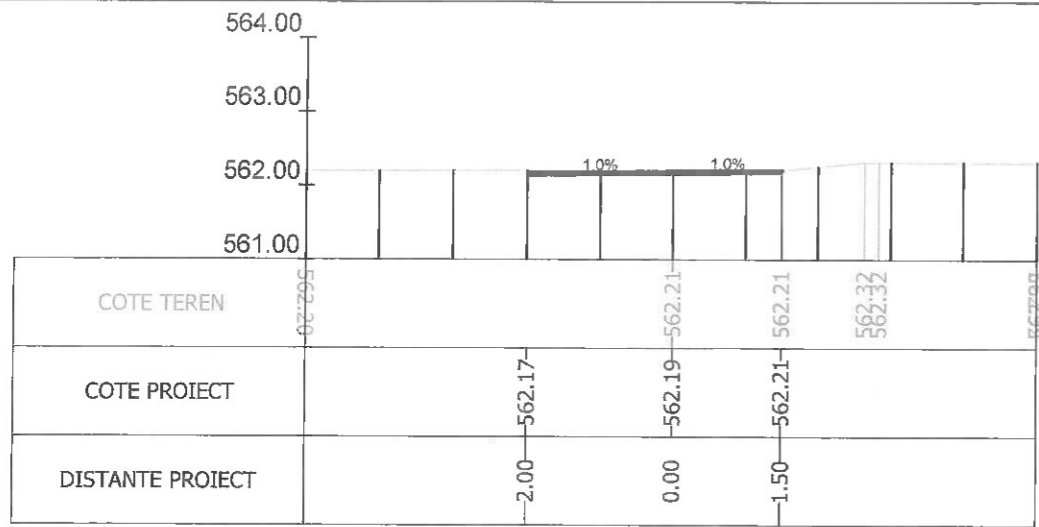

Sectiunea 358 - Km 4+820.304
Ax-Traseul 1

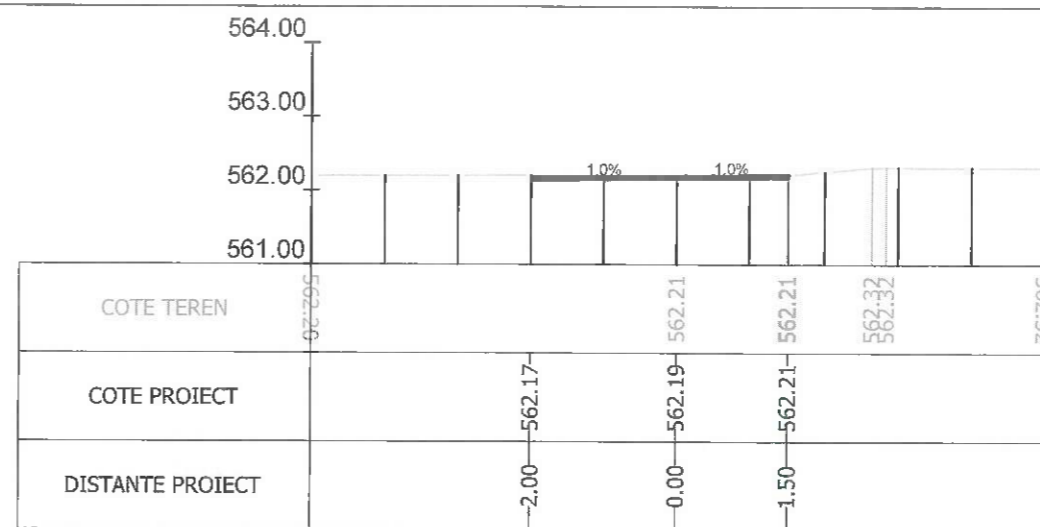

Sectiunea 359 - Km 4+820.305
Ax-Traseul 1

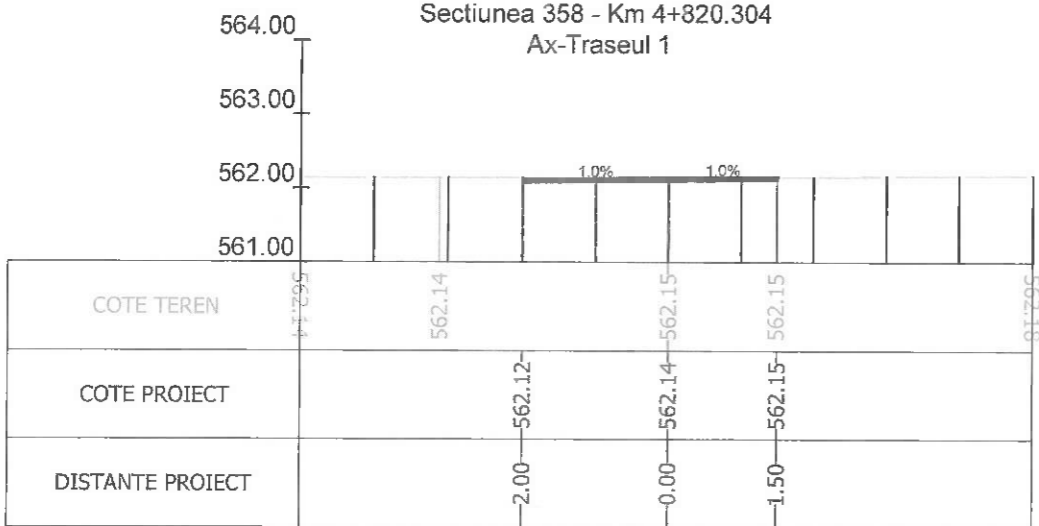

Sectiunea 360 - Km 4+825
Ax-Traseul 1

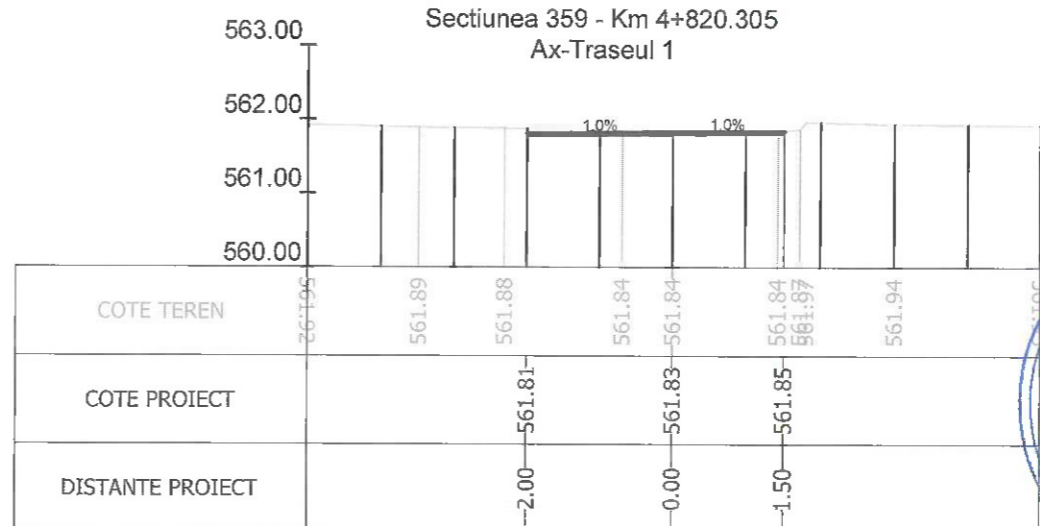

Sectiunea 361 - Km 4+850
Ax-Traseul 1

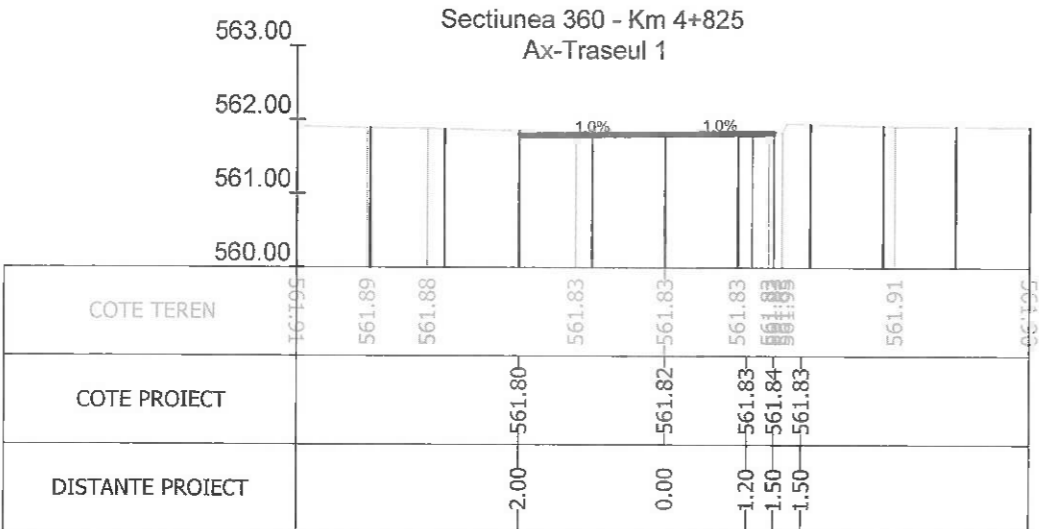

Sectiunea 362 - Km 4+850.899
Ax-Traseul 1

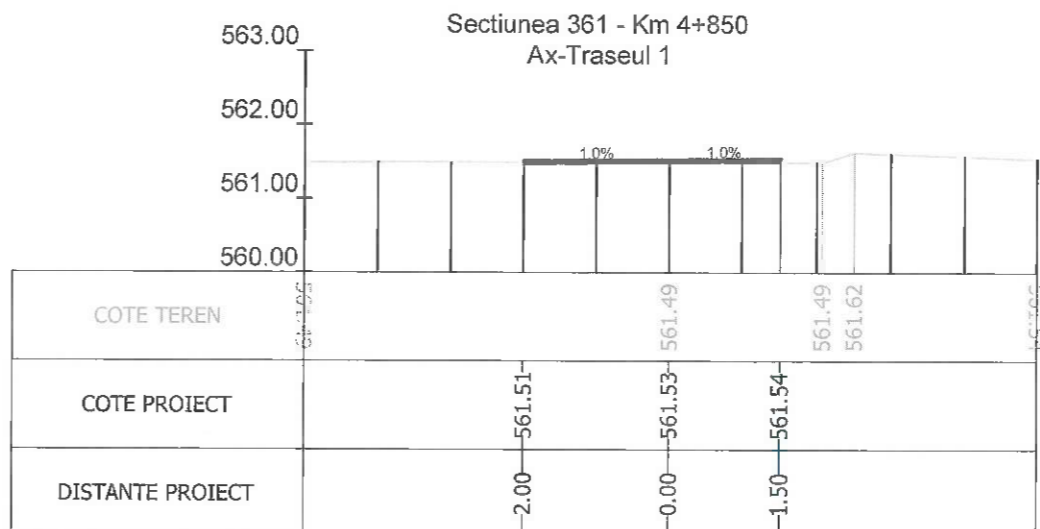

Sectiunea 363 - Km 4+875
Ax-Traseul 1



Index	Data	Observatii	Rev. 5
A			
			Beneficiar: MUNICIPIUL BRASOV Bulevardul Eroilor 8, Brasov 500007
			Nr. proiect: 73 / 2020
Sef Proiect: Ing. A. Buta Proiectat: Ing. A. Buta Desenat: Ing. S. Patroi Verificat:			Titlu proiect: INFRASTRUCTURA INTEGRATA PENTRU CICLISM SI TRAFIC PIETONAL CU FACILITATI COMPLEMENTARE - TRASEUL 1
Scara: 1:100 Data: 07/2023			Faza P.T.
			Nr. plansa PTC 43
			Titlu plansa: PROFILURI TRANSVERSALE TIP

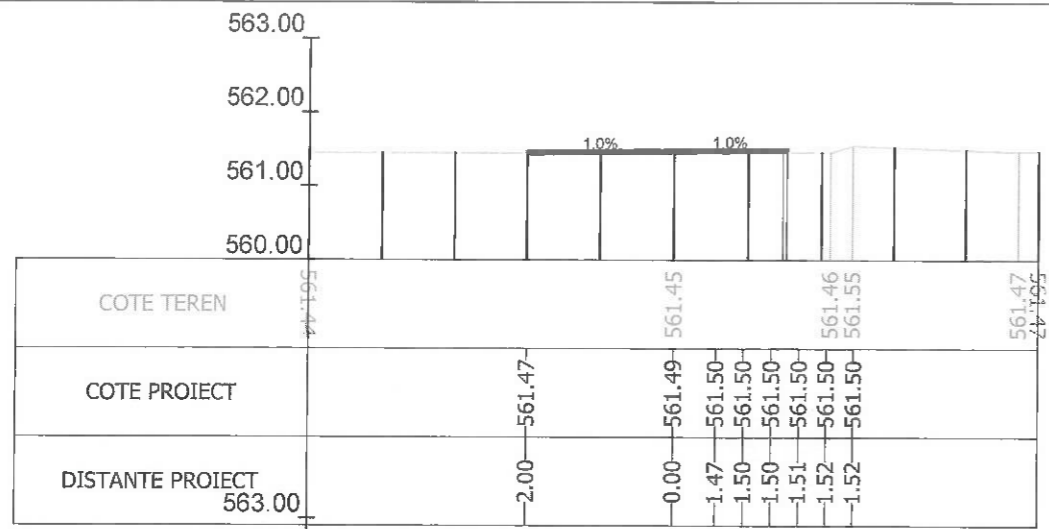

Sectiunea 364 - Km 4+878.214
Ax-Traseul 1

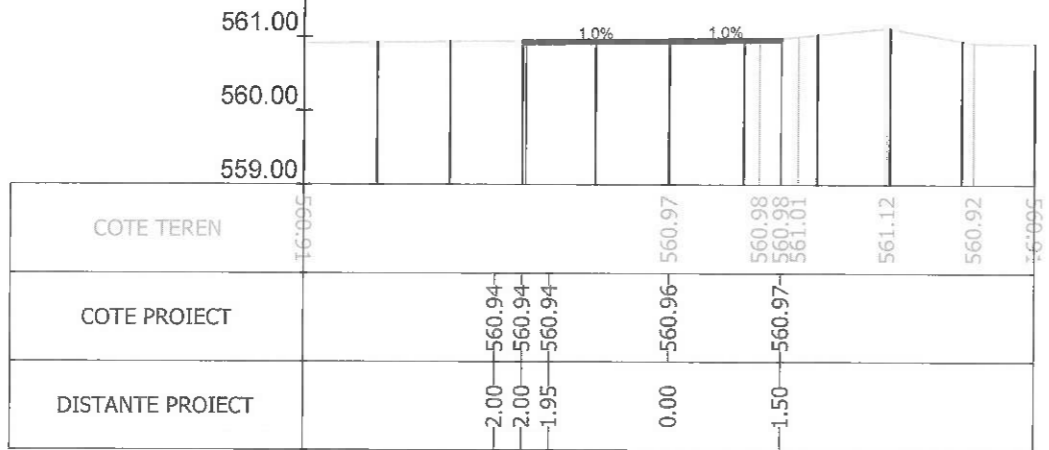

Sectiunea 366 - Km 4+924.303
Ax-Traseul 1

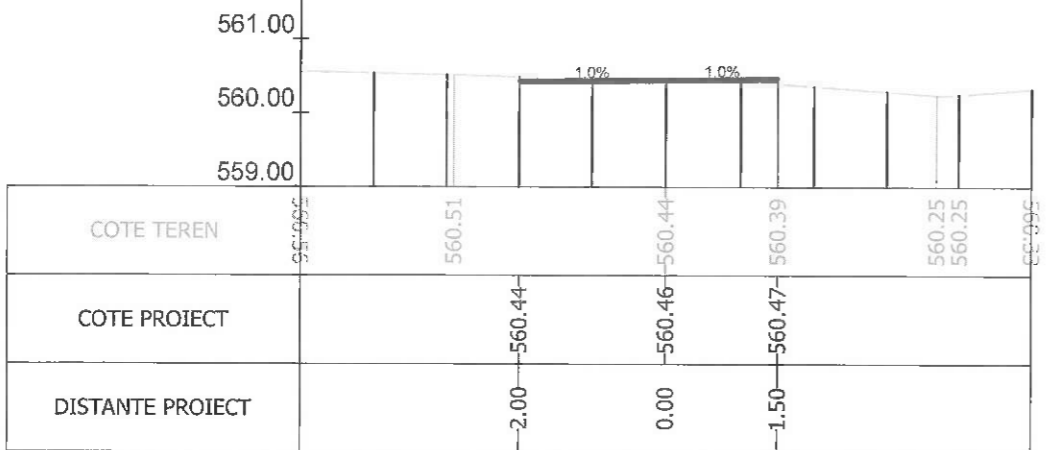

Sectiunea 368 - Km 4+950
Ax-Traseul 1

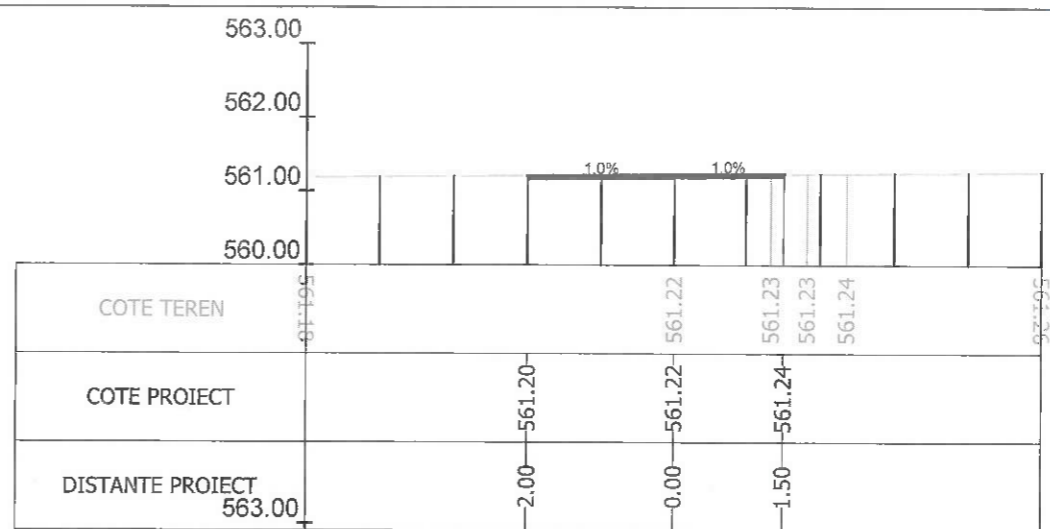

Sectiunea 365 - Km 4+900
Ax-Traseul 1

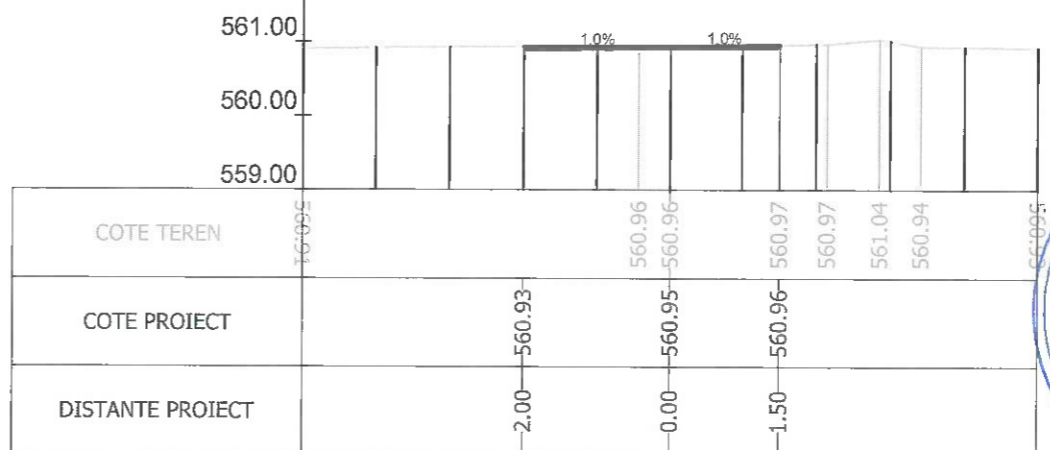

Sectiunea 367 - Km 4+925
Ax-Traseul 1

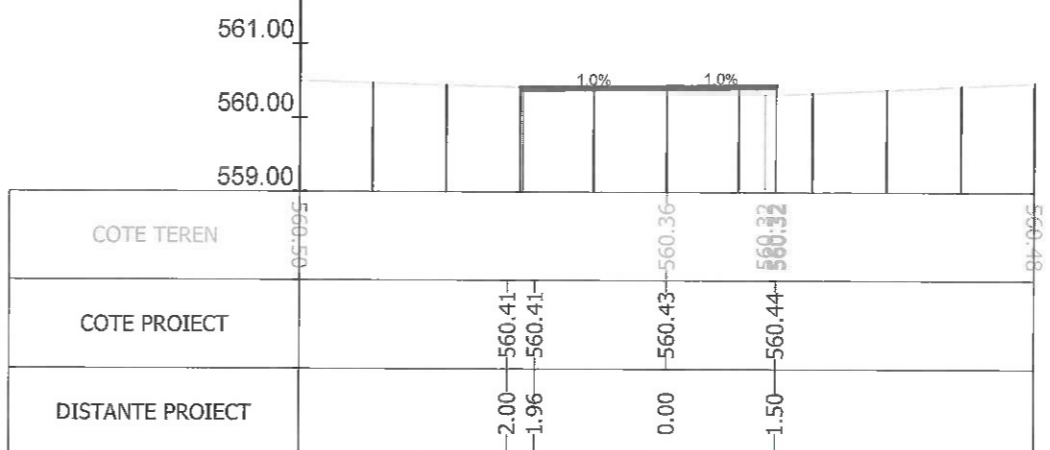

Sectiunea 369 - Km 4+953.376
Ax-Traseul 1



Index	Data	Observatii	Rev. 5
A			
		Beneficiar:	MUNICIPIUL BRASOV Bulevardul Eroilor 8, Brasov 500007
		Tytu proiect:	INFRASTRUCTURA INTEGRATA PENTRU CICLISM SI TRAFIC PIETONAL CU FACILITATI COMPLEMENTARE - TRASEUL 1
		Tytu plansa:	PROFILURI TRANSVERSALE TIP
Sef Proiect	Ing. A. Buta	Scara	Nr. proiect 73 / 2020
Proiectat	Ing. A. Buta	1:100	Faza P.T.
Desenat	Ing. S. Patroi	Data	Nr. plansa PTC 44
Verificat		07/2023	

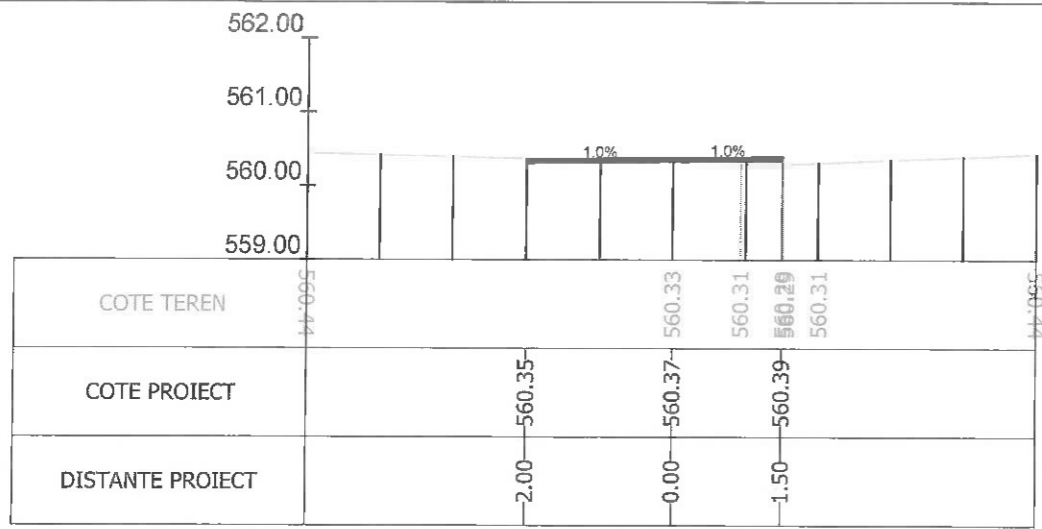

Sectiunea 370 - Km 4+972.363
Ax-Traseul 1

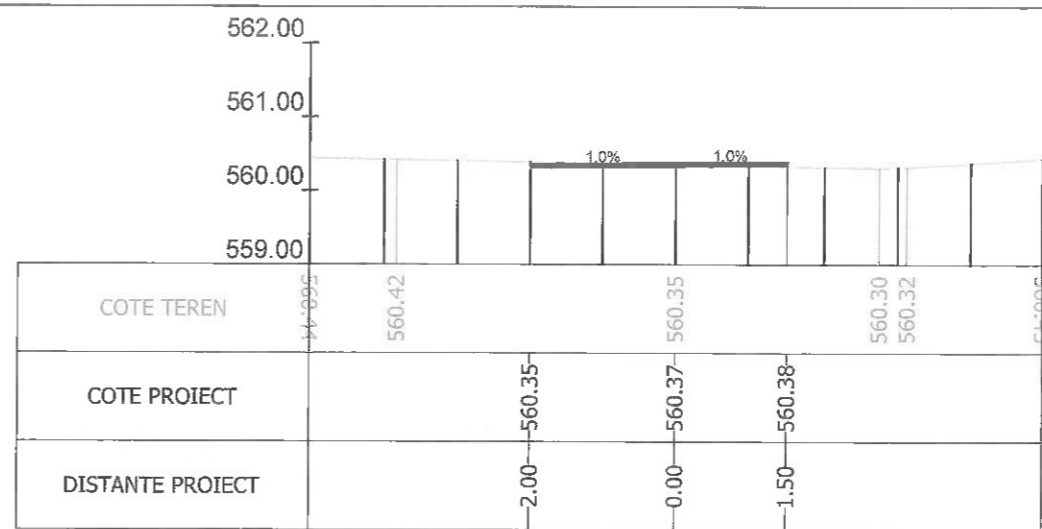

Sectiunea 371 - Km 4+975
Ax-Traseul 1

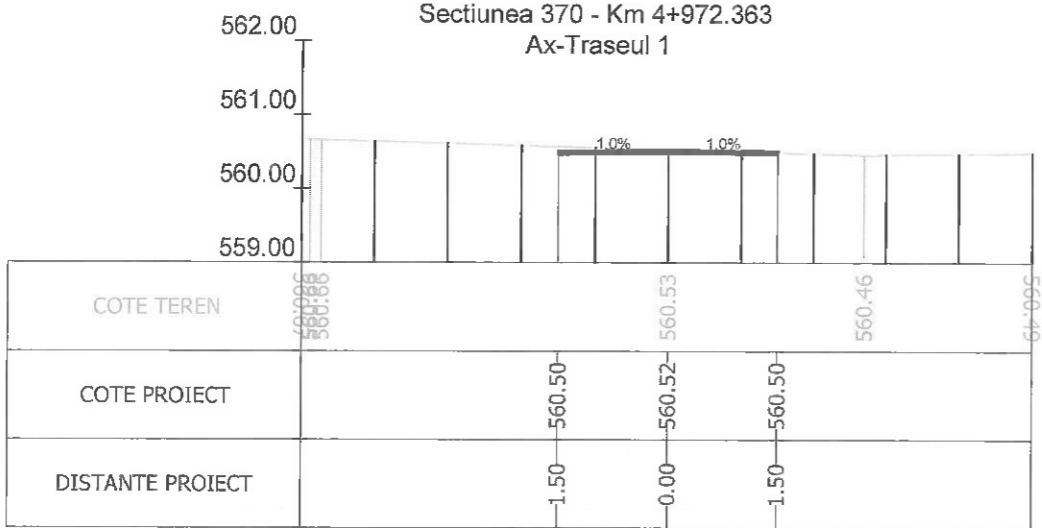

Sectiunea 377 - Km 5+008.491
Ax-Traseul 1

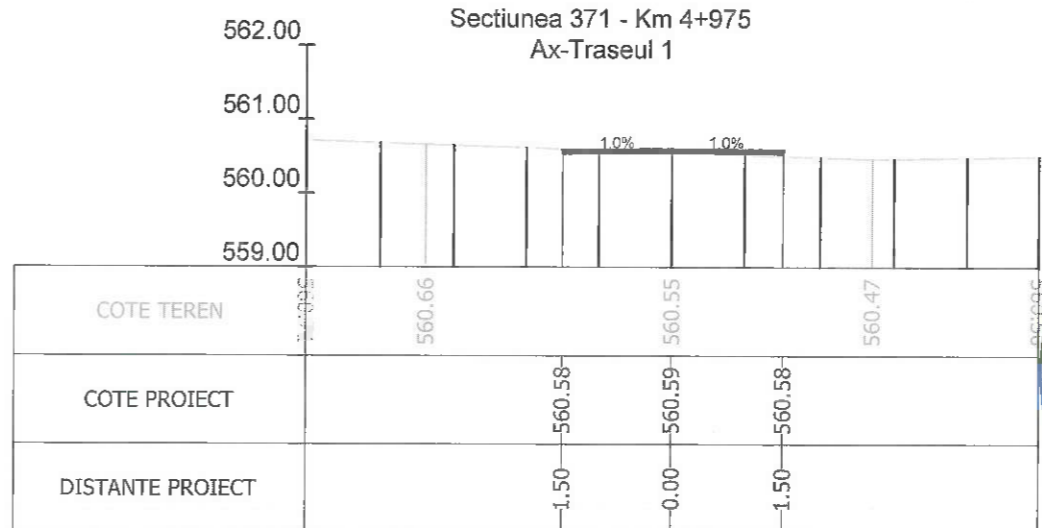

Sectiunea 378 - Km 5+025
Ax-Traseul 1

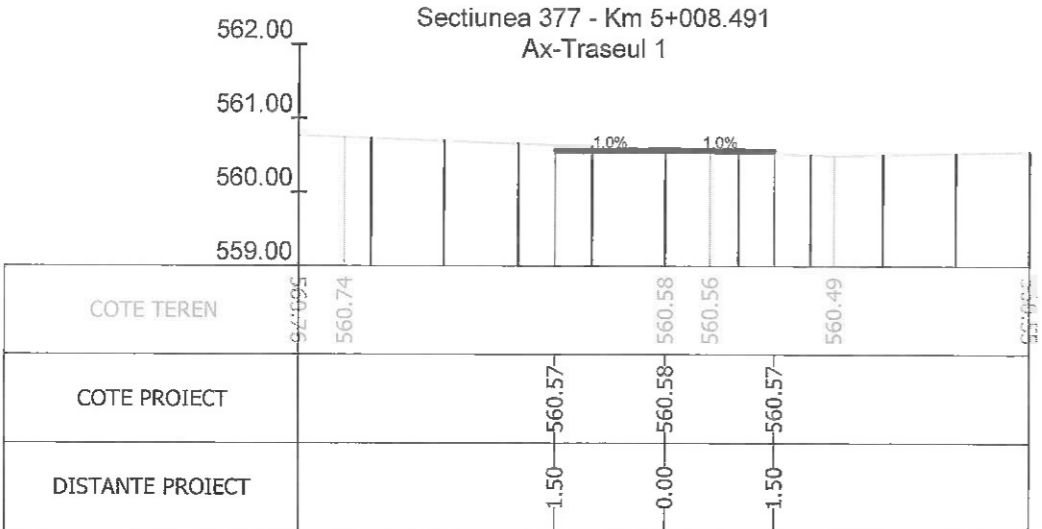

Sectiunea 379 - Km 5+043.449
Ax-Traseul 1

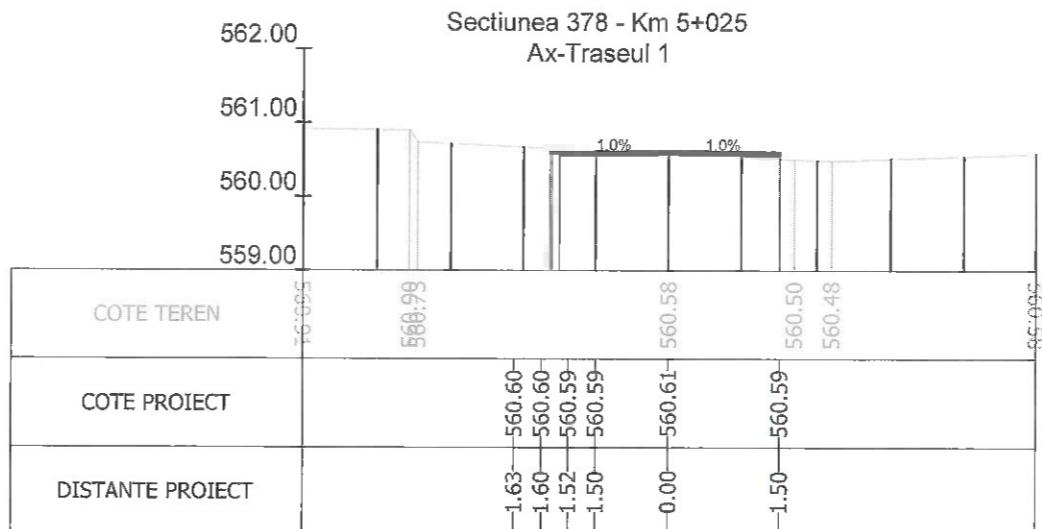

Sectiunea 380 - Km 5+050
Ax-Traseul 1

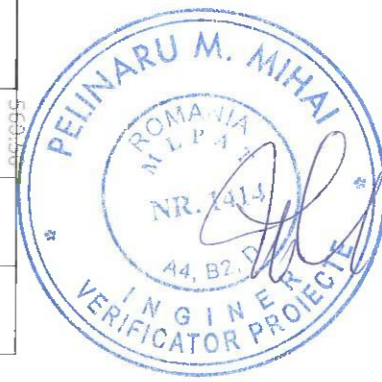

Index	Data	Observatii	Rev. 5
A			
		Beneficiar:	MUNICIPIUL BRASOV Bulevardul Eroilor 8, Brasov 500007
		Titlu proiect:	INFRASTRUCTURA INTEGRATA PENTRU CICLISM SI TRAFIC PIETONAL CU FACILITATI COMPLEMENTARE - TRASEUL 1
		Titlu plansa:	PROFILURI TRANSVERSALE TIP
Sef Proiect	Ing. A. Buta	Scara	Nr. proiect
Proiectat	Ing. A. Buta	1:100	73 / 2020
Desenat	Ing. S. Patroi	Data	Faza
Verificat		07/2023	P.T.
			Nr. plansa
			PTC 45

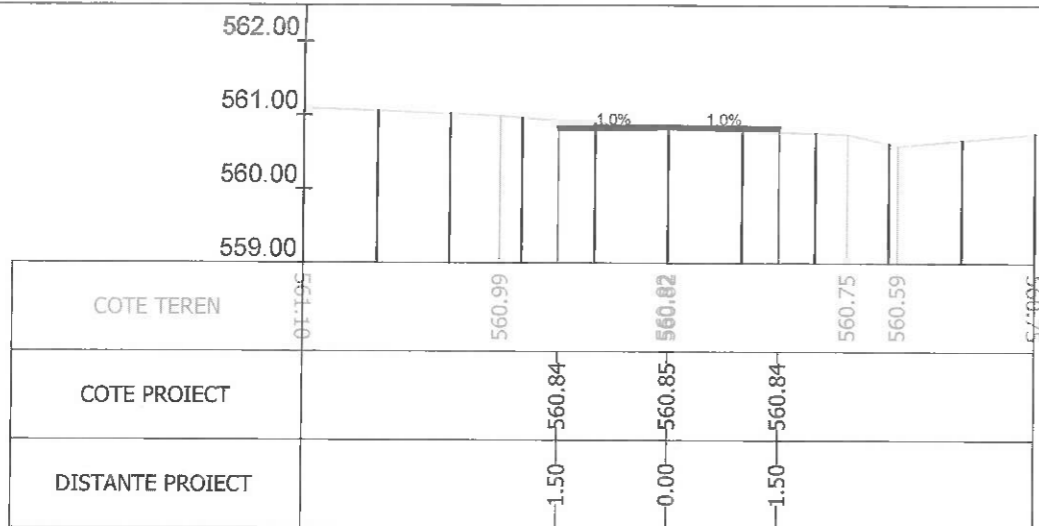

Sectiunea 381 - Km 5+064.292
Ax-Traseul 1

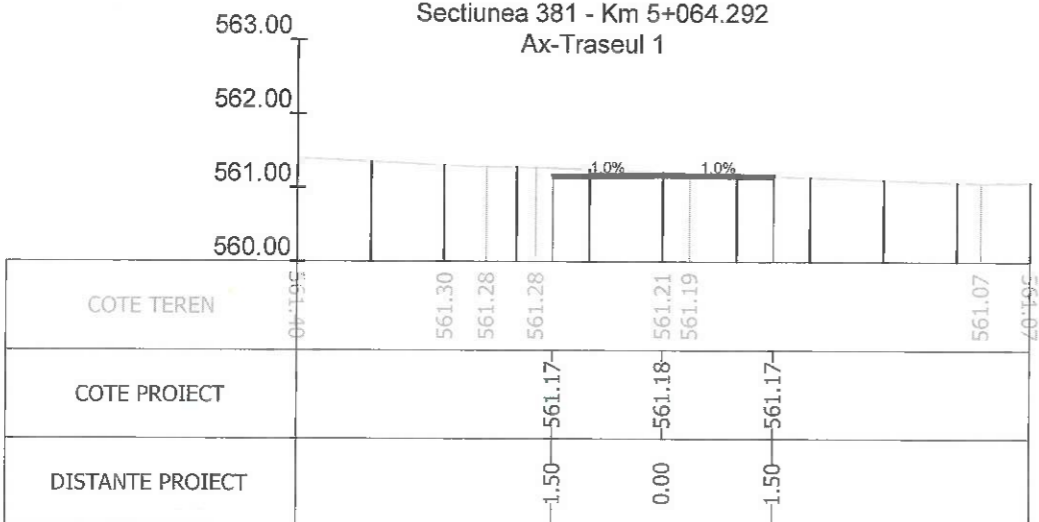

Sectiunea 382 - Km 5+075
Ax-Traseul 1

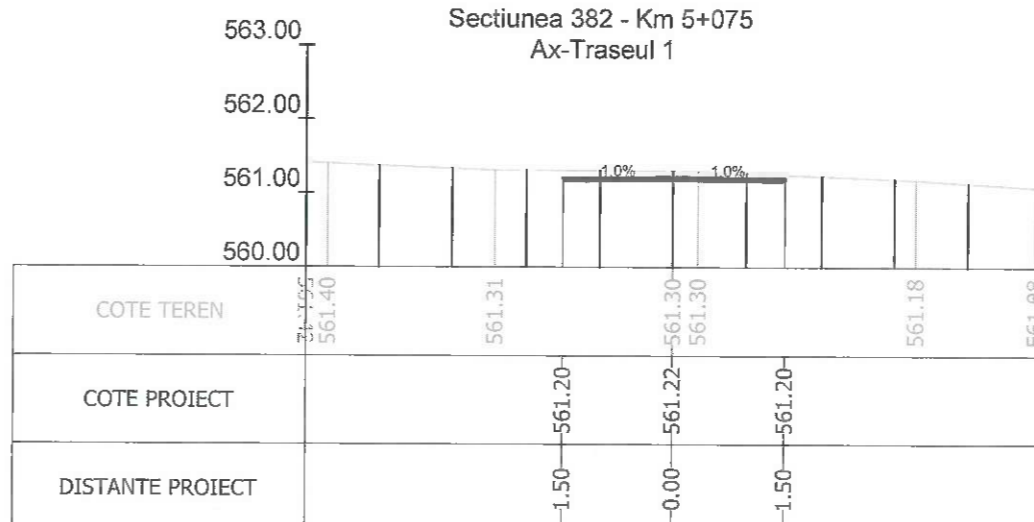

Sectiunea 384 - Km 5+087.786
Ax-Traseul 1

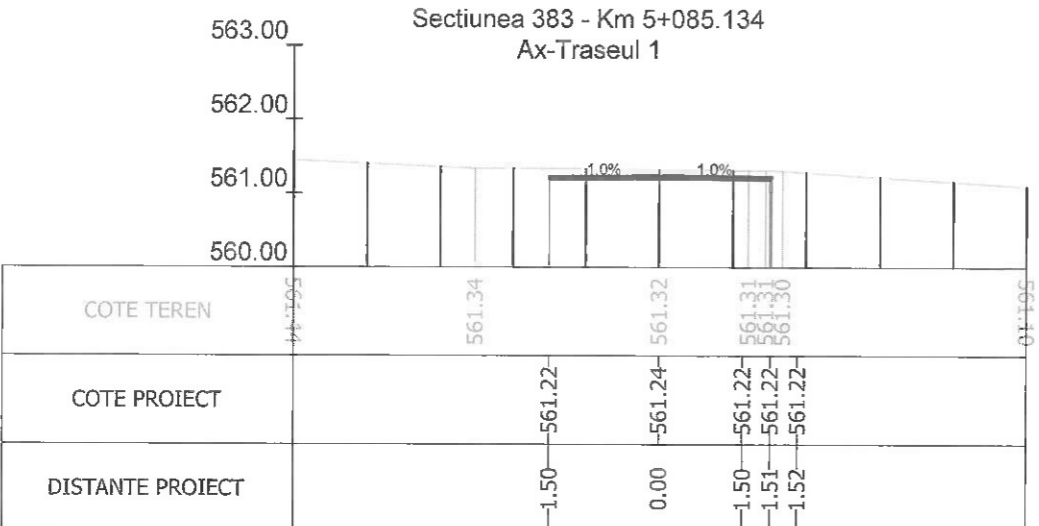

Sectiunea 385 - Km 5+089.474
Ax-Traseul 1

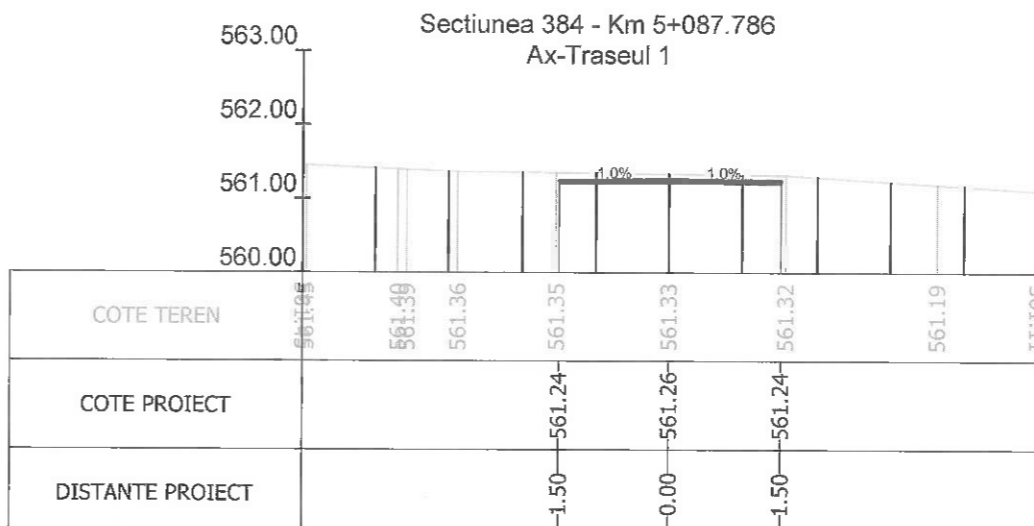

Sectiunea 386 - Km 5+091.163
Ax-Traseul 1



Index	Data	Observatii	Rev. 5
A			
		Beneficiar:	MUNICIPIUL BRASOV Bulevardul Eroilor 8, Brasov 500007
		Nr. proiect	73 / 2020
		Titlu proiect:	INFRASTRUCTURA INTEGRATA PENTRU CICLISM SI TRAFIC PIETONAL CU FACILITATI COMPLEMENTARE - TRASEUL 1
		Faza	P.T.
		Titlu plansa:	PROFILURI TRANSVERSALE TIP
		Nr. plansa	PTC 46
Sef Proiect	Ing. A. Buta	Scara	1:100
Proiectat	Ing. A. Buta	Data	07/2023
Desenat	Ing. S. Patroi		
Verificat			

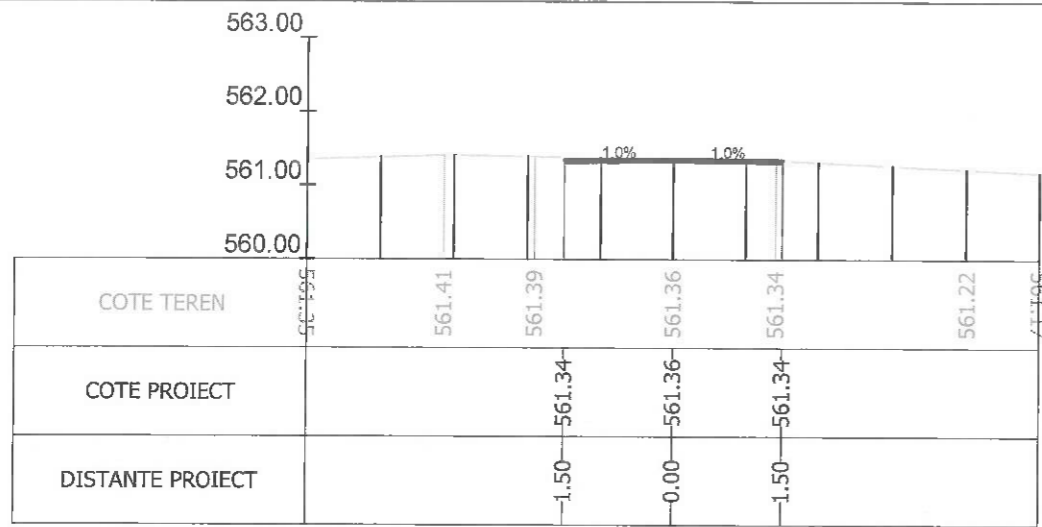

Sectiunea 387 - Km 5+100
Ax-Traseul 1

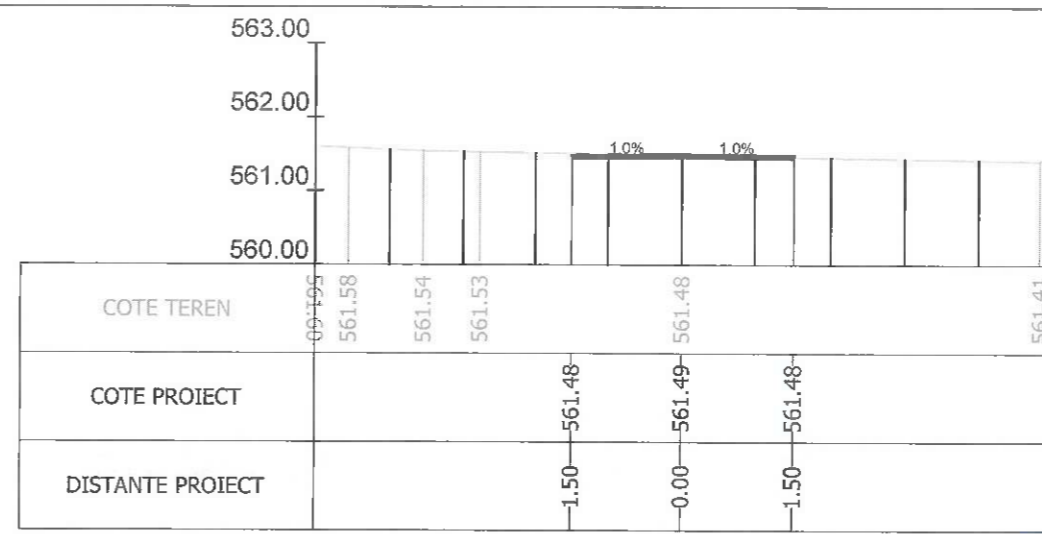

Sectiunea 388 - Km 5+125
Ax-Traseul 1

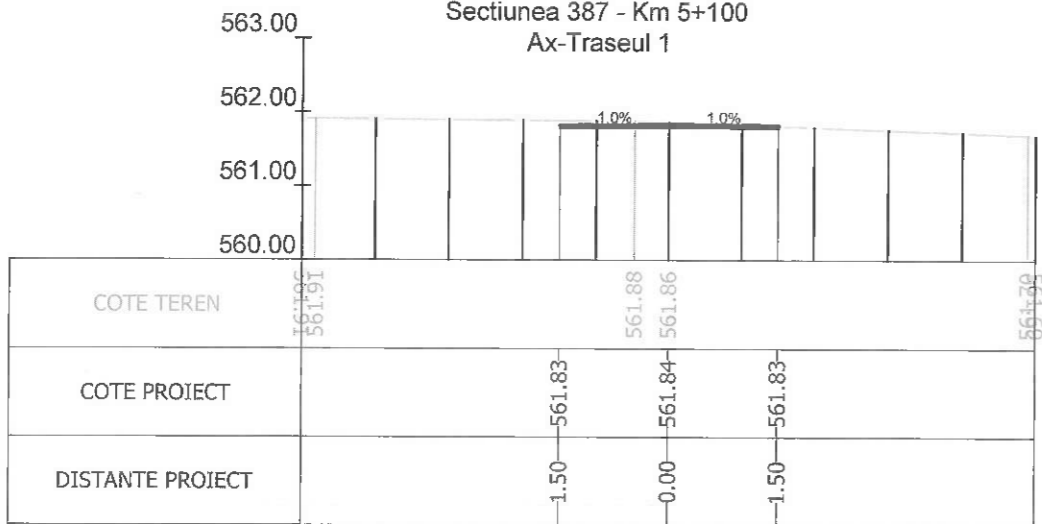

Sectiunea 389 - Km 5+150
Ax-Traseul 1

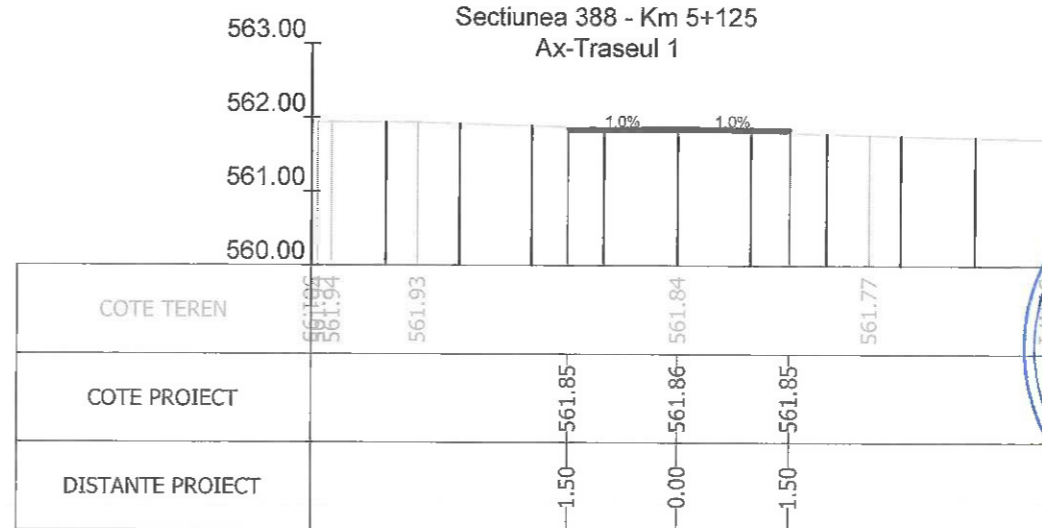

Sectiunea 390 - Km 5+157.555
Ax-Traseul 1

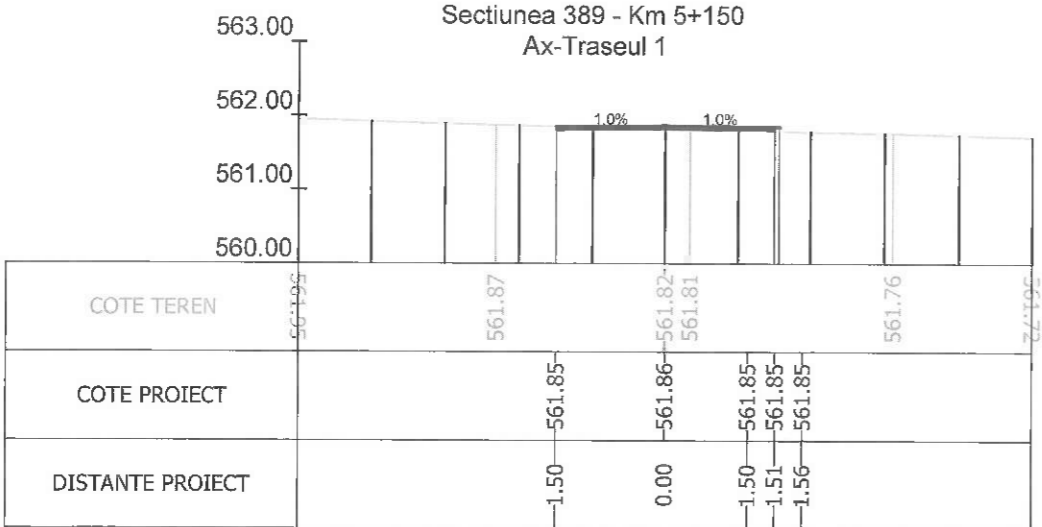

Sectiunea 391 - Km 5+162.583
Ax-Traseul 1

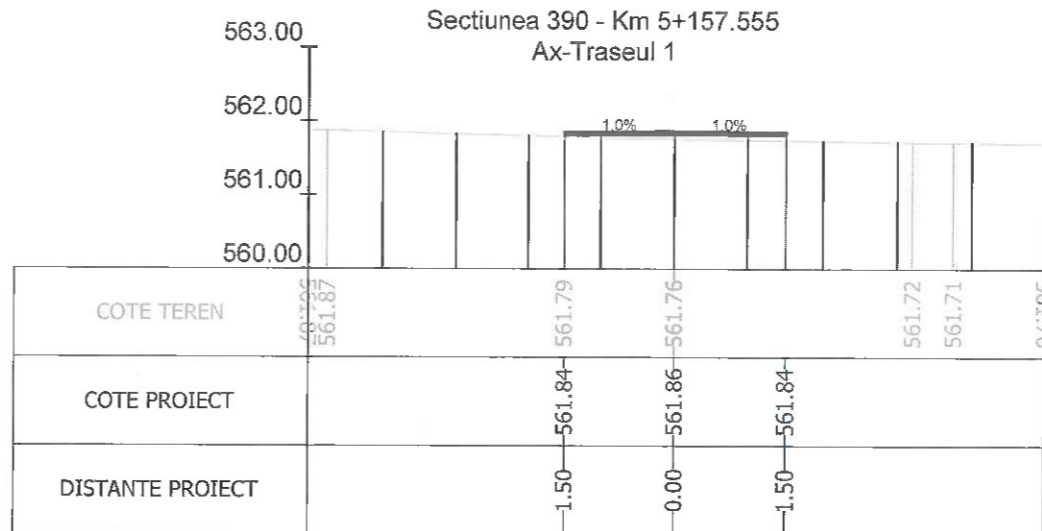

Sectiunea 392 - Km 5+167.611
Ax-Traseul 1

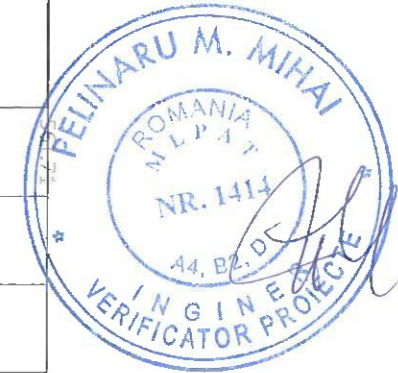

Index	Data	Observatii	Rev. 5
A			
		Beneficiar:	MUNICIPIUL BRASOV Bulevardul Eroilor 8, Brasov 500007
		Nr. proiect	73 / 2020
		Titlu proiect:	INFRASTRUCTURA INTEGRATA PENTRU CICLISM SI TRAFIC PIETONAL CU FACILITATI COMPLEMENTARE - TRASEUL 1
		Faza	P.T.
		Titlu plansa:	PROFILURI TRANSVERSALE TIP
		Nr. plansa	PTC 47
Sef Proiect	Ing. A. Buta	Scara	1:100
Proiectat	Ing. A. Buta	Data	07/2023
Desenat	Ing. S. Patro		
Verificat			

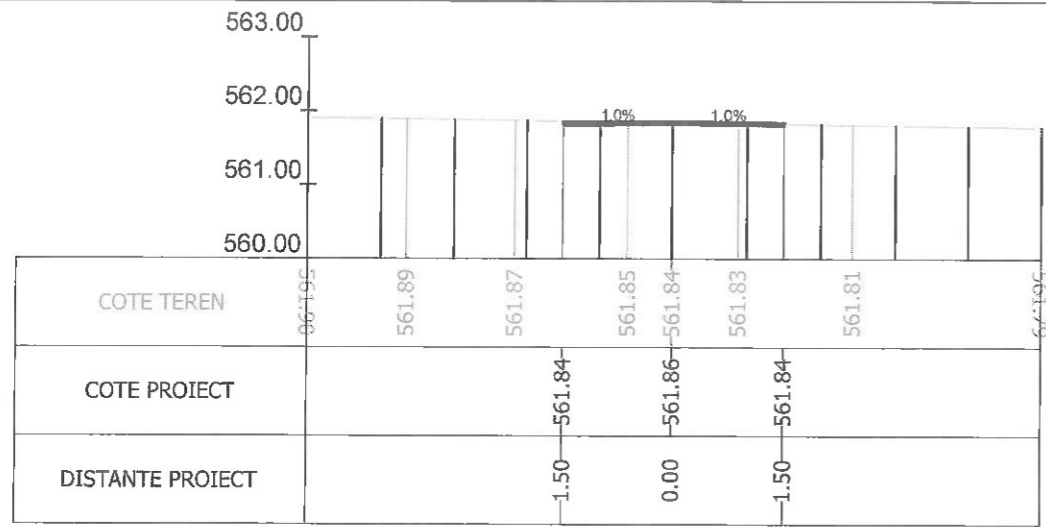

Sectiunea 393 - Km 5+175
Ax-Traseul 1

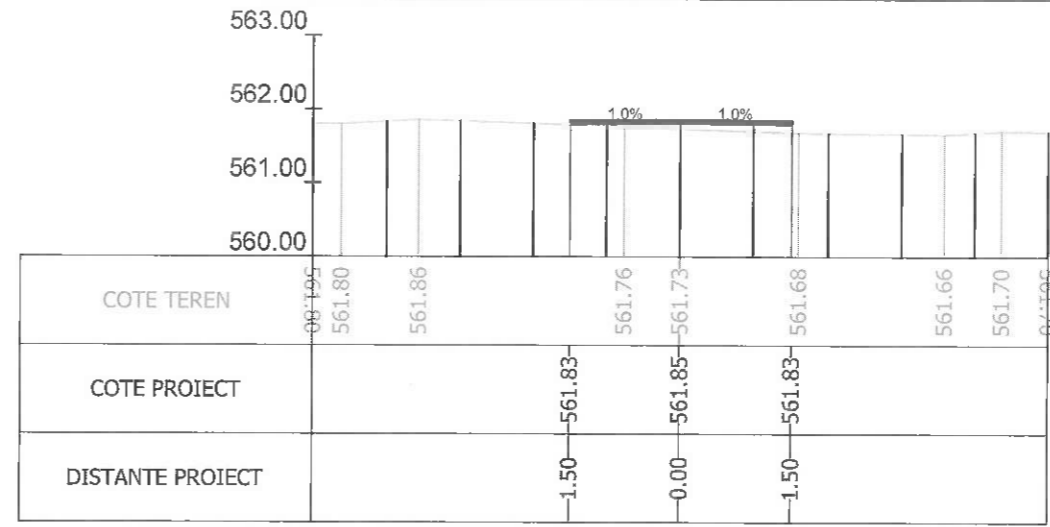

Sectiunea 394 - Km 5+195.834
Ax-Traseul 1

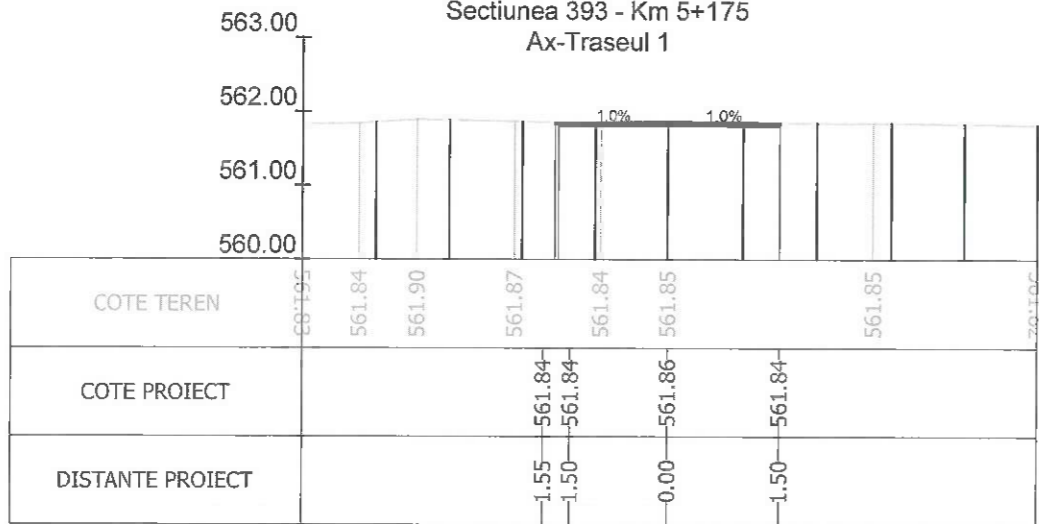

Sectiunea 395 - Km 5+200
Ax-Traseul 1

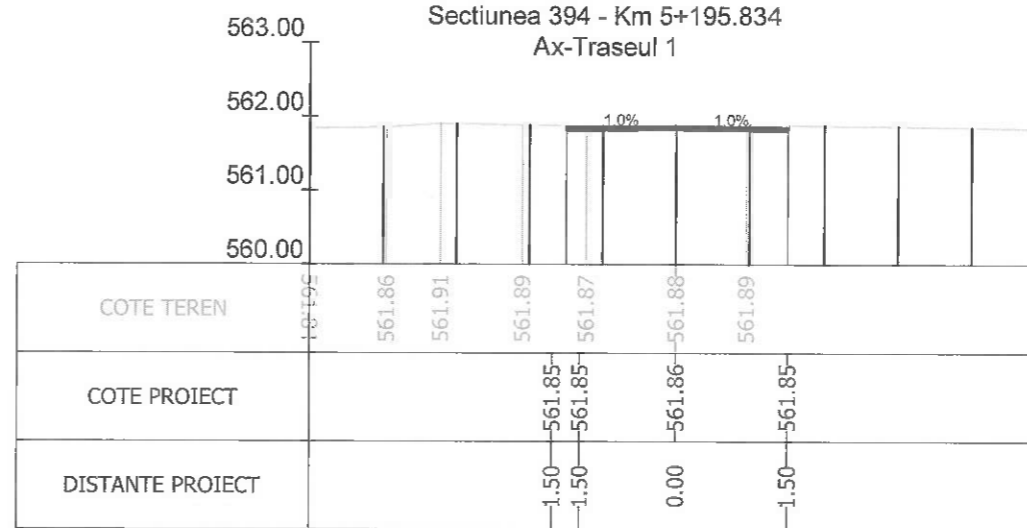

Sectiunea 396 - Km 5+200.941
Ax-Traseul 1

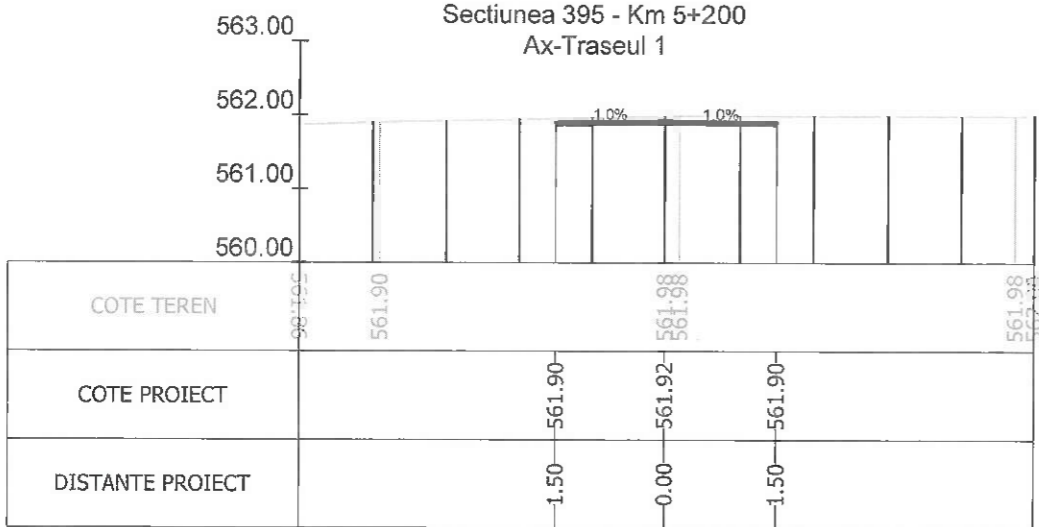

Sectiunea 397 - Km 5+206.049
Ax-Traseul 1

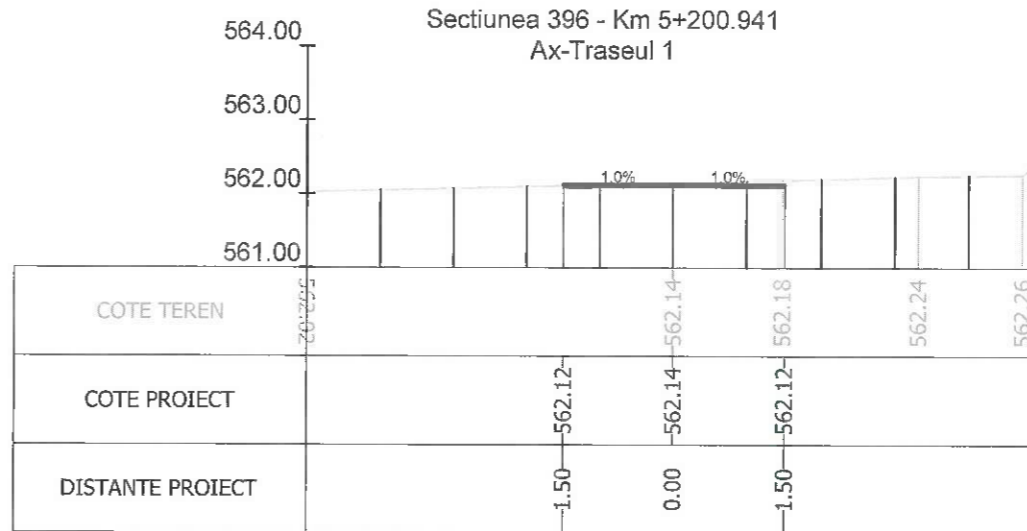

Sectiunea 398 - Km 5+225
Ax-Traseul 1

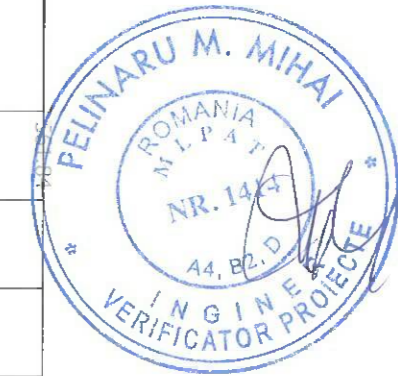

Index	Data	Observatii	Rev. 5
A			
		Beneficiar:	MUNICIPIUL BRASOV Bulevardul Eroilor 8, Brasov 500007
		Tytu proiect:	INFRASTRUCTURA INTEGRATA PENTRU CICLISM SI TRAFIC PIETONAL CU FACILITATI COMPLEMENTARE - TRASEUL 1
		Tytu plansa:	PROFILURI TRANSVERSALE TIP
Sef Proiect	Ing. A. Buta	Scara	1:100
Proiectat	Ing. A. Buta	Data	07/2023
Desenat	Ing. S. Patroi		
Verificat			
			Nr. proiect 73 / 2020
			Faza P.T.
			Nr. plansa PTC 48

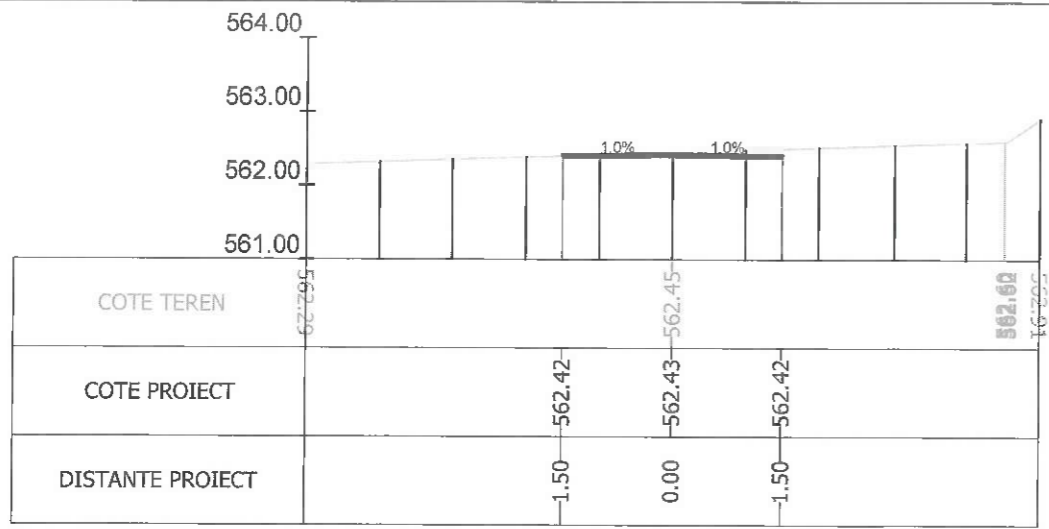

Sectiunea 399 - Km 5+250
Ax-Traseul 1

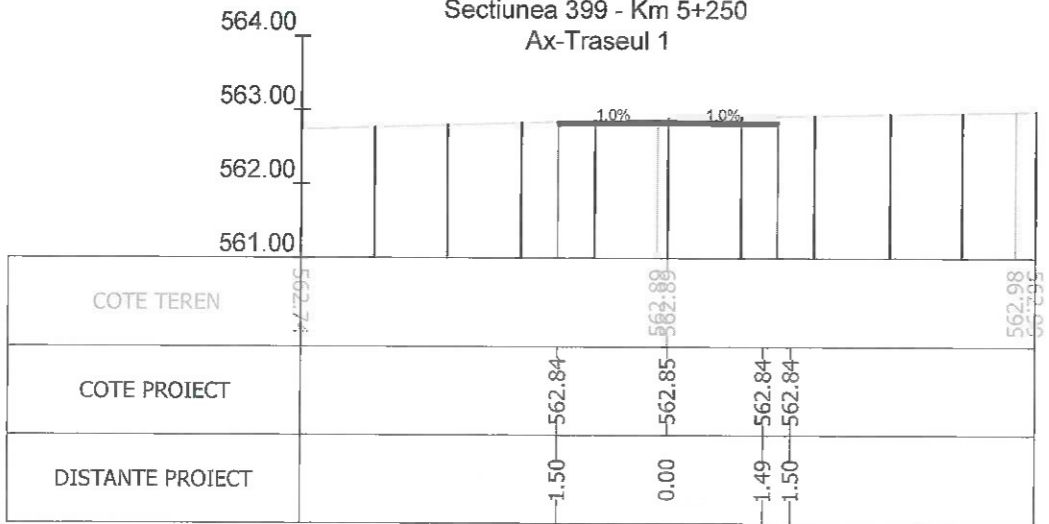

Sectiunea 401 - Km 5+285.785
Ax-Traseul 1

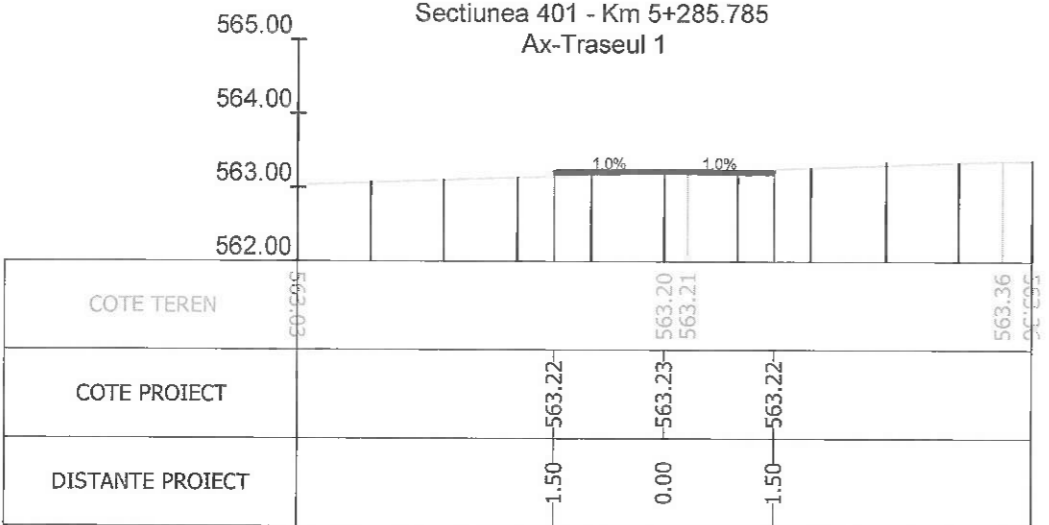

Sectiunea 403 - Km 5+325
Ax-Traseul 1

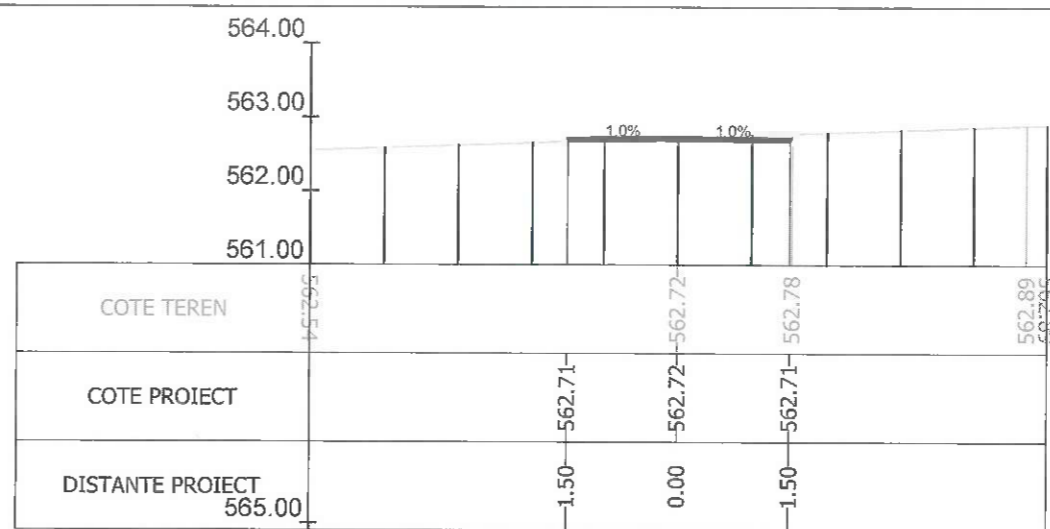

Sectiunea 400 - Km 5+275
Ax-Traseul 1

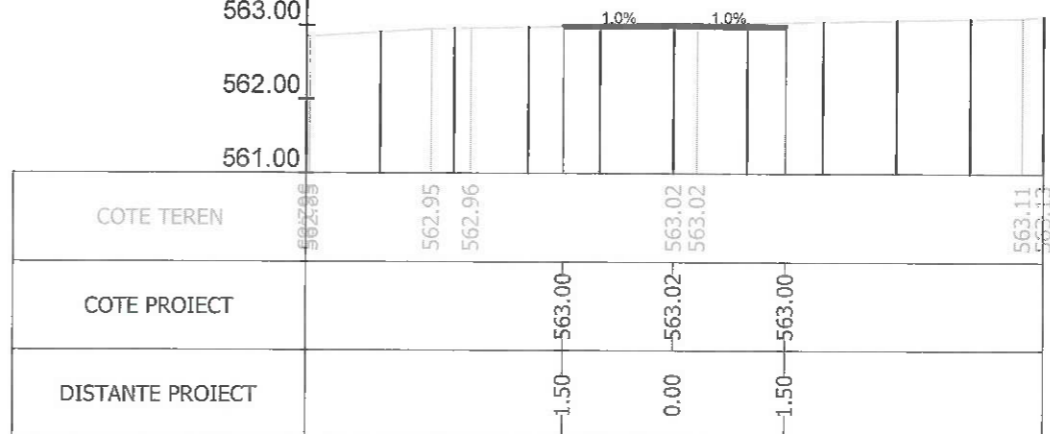

Sectiunea 402 - Km 5+300
Ax-Traseul 1

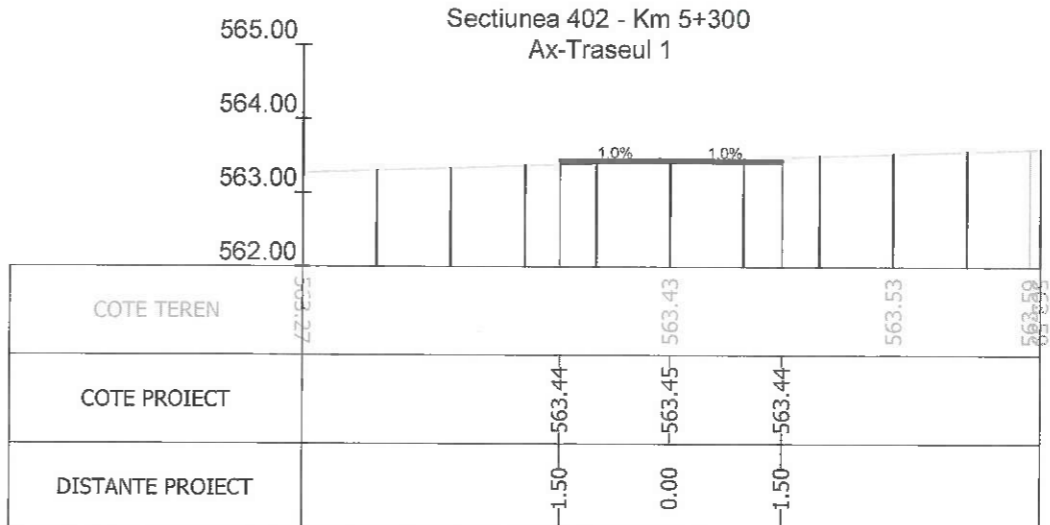

Sectiunea 404 - Km 5+350
Ax-Traseul 1



Index	Data	Observatii	Rev. 5
A			
		Beneficiar:	MUNICIPIUL BRASOV Bulevardul Eroilor 8, Brasov 500007
		Titlu proiect:	INFRASTRUCTURA INTEGRATA PENTRU CICLISM SI TRAFIC PIETONAL CU FACILITATI COMPLEMENTARE - TRASEUL 1
		Titlu plansa:	PROFILURI TRANSVERSALE TIP
Sef Proiect	Ing. A. Buta	Scara	Nr. proiect
Proiectat	Ing. A. Buta	1:100	73 / 2020
Desenat	Ing. S. Patroi	Data	Faza
Verificat		07/2023	P.T.
			Nr. plansa
			PTC 49

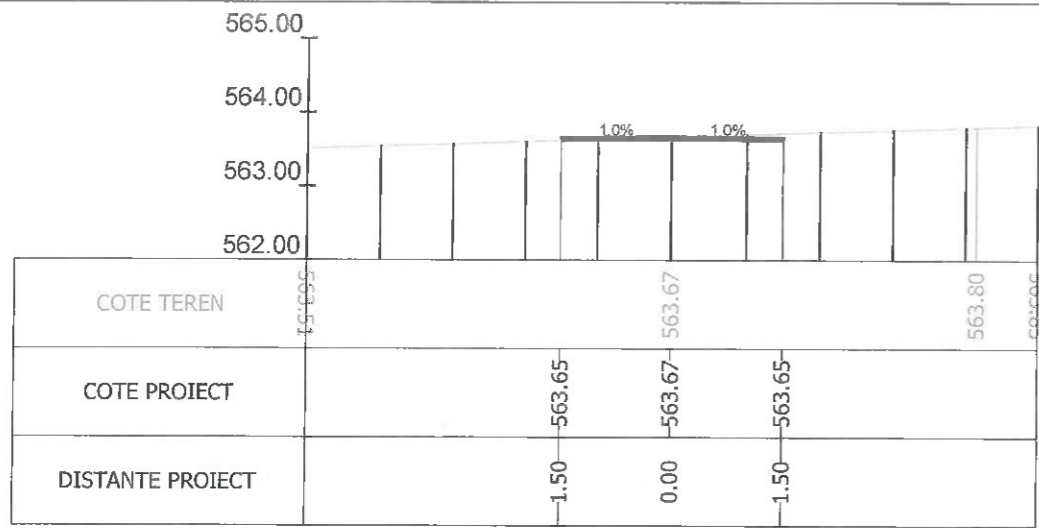

Sectiunea 405 - Km 5+375
Ax-Traseul 1

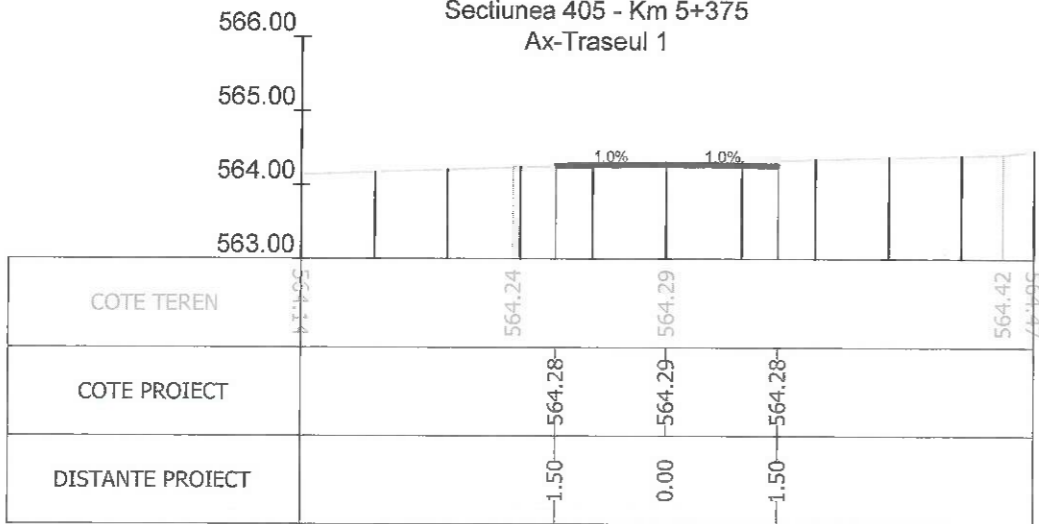

Sectiunea 406 - Km 5+400
Ax-Traseul 1

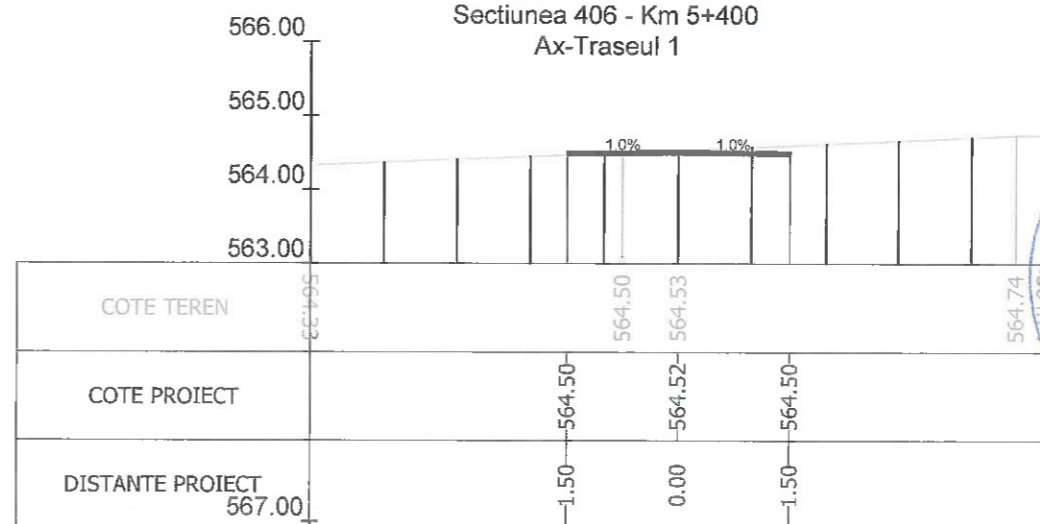

Sectiunea 407 - Km 5+425
Ax-Traseul 1

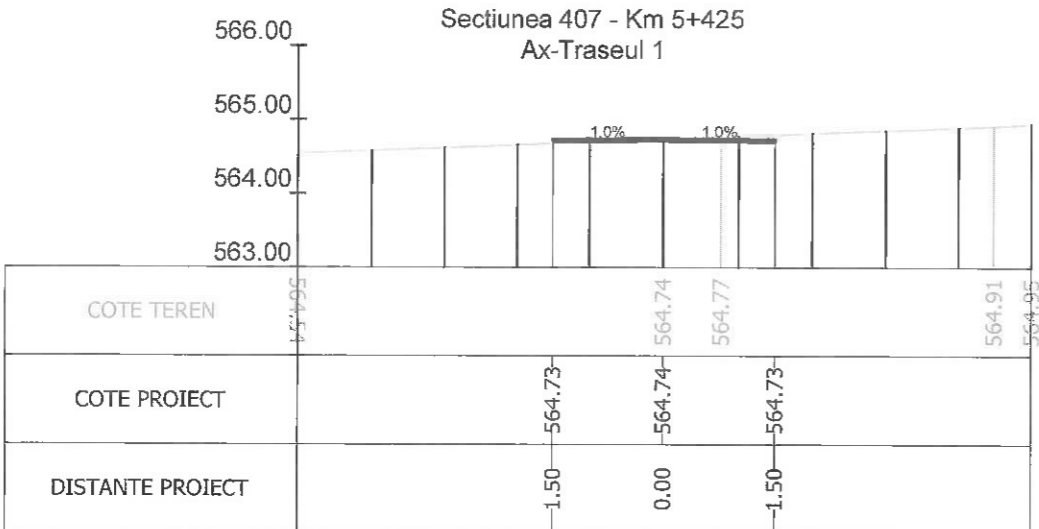

Sectiunea 408 - Km 5+450
Ax-Traseul 1

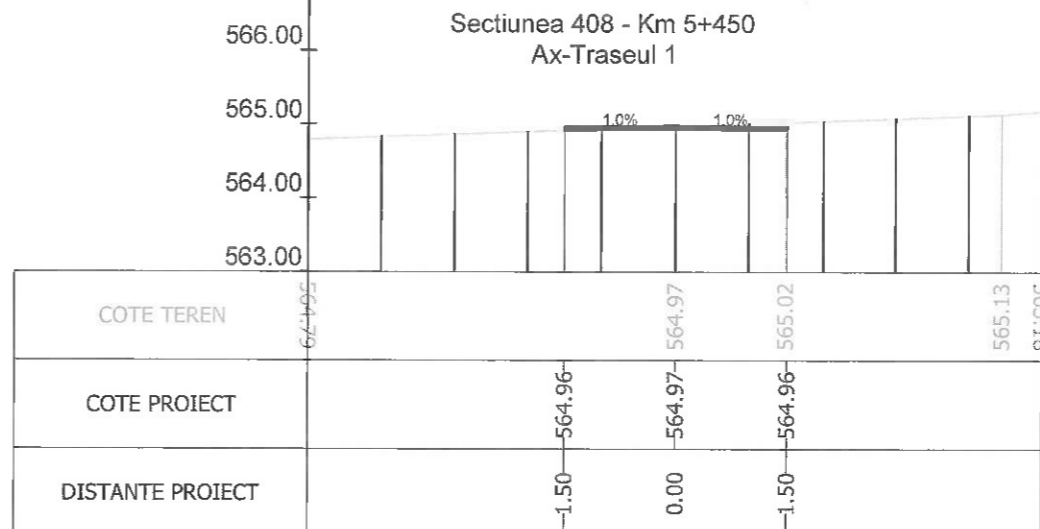

Sectiunea 409 - Km 5+475
Ax-Traseul 1

Sectiunea 410 - Km 5+500
Ax-Traseul 1



Index	Data	Observatii	Rev. 5
A			
		Beneficiar:	MUNICIPIUL BRASOV Bulevardul Eroilor 8, Brasov 500007
		Beneficiar:	MUNICIPIUL BRASOV Bulevardul Eroilor 8, Brasov 500007
		Titlu proiect:	INFRASTRUCTURA INTEGRATA PENTRU CICLISM SI TRAFIC PIETONAL CU FACILITATI COMPLEMENTARE - TRASEUL 1
		Titlu plansa:	PROFILURI TRANSVERSALE TIP
Sef Proiect	Ing. A. Buta	Scara	1:100
Proiectat	Ing. A. Buta	Data	07/2023
Desenat	Ing. S. Patroi		
Verificat			
			Nr. proiect 73 / 2020
			Faza P.T.
			Nr. plansa PTC 50

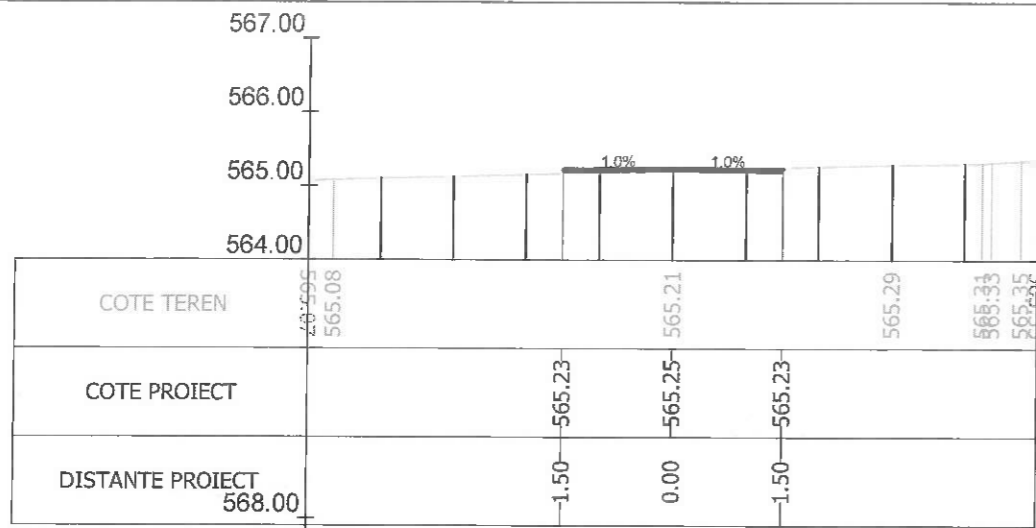

Sectiunea 411 - Km 5+525
Ax-Traseul 1

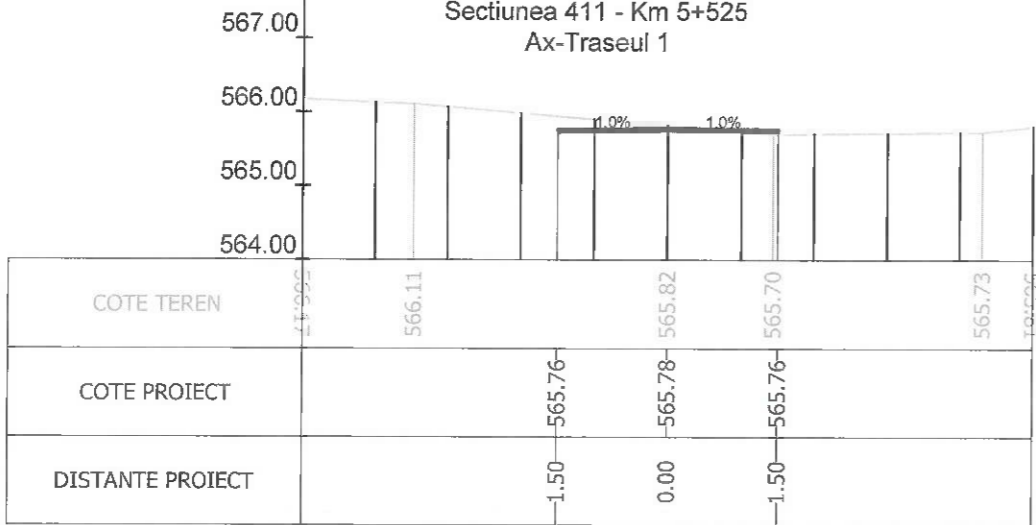

Sectiunea 412 - Km 5+550
Ax-Traseul 1

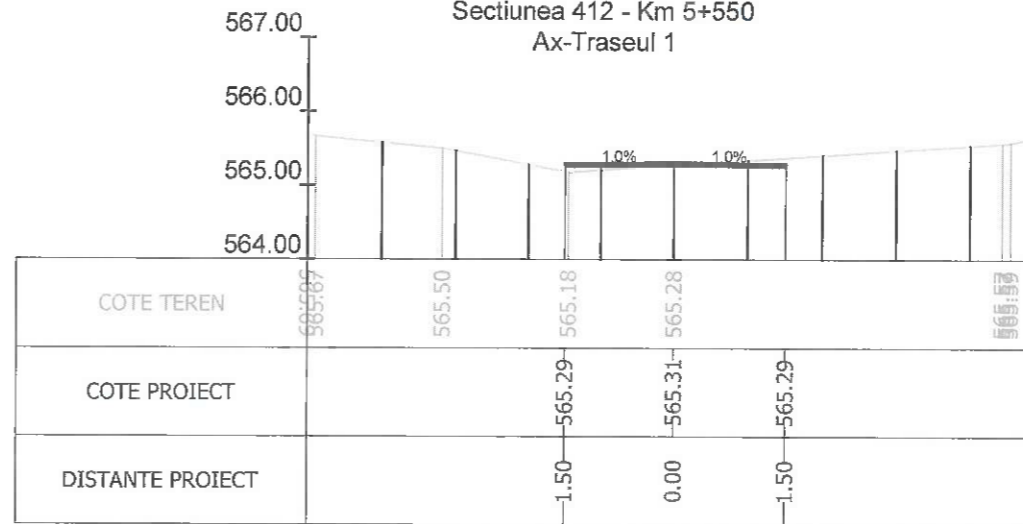

Sectiunea 413 - Km 5+575
Ax-Traseul 1

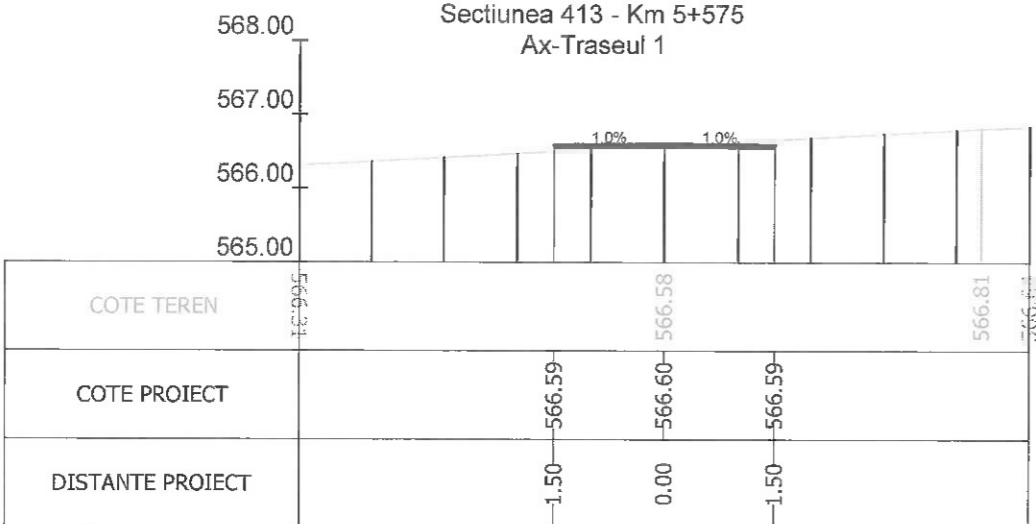

Sectiunea 414 - Km 5+600
Ax-Traseul 1

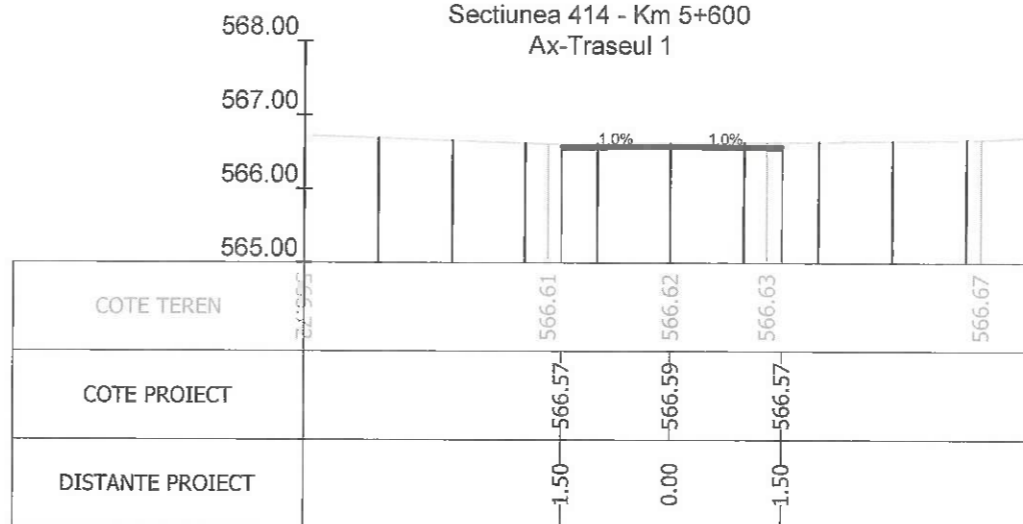

Sectiunea 415 - Km 5+625
Ax-Traseul 1

Sectiunea 416 - Km 5+650
Ax-Traseul 1

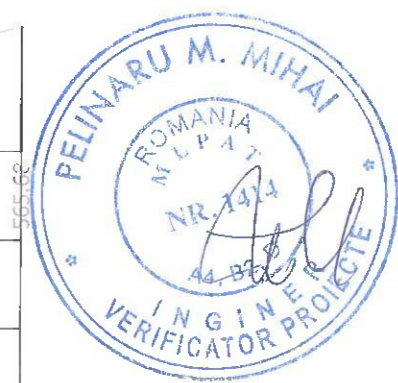

Index	Data	Observatii	Rev. 5
A			
		Beneficiar:	MUNICIPIUL BRASOV Bulevardul Eroilor 8, Brasov 500007
		Nr. proiect	73 / 2020
		Titlu proiect:	INFRASTRUCTURA INTEGRATA PENTRU CICLISM SI TRAFIC PIETONAL CU FACILITATI COMPLEMENTARE - TRASEUL 1
		Faza	P.T.
		Titlu plansa:	PROFILURI TRANSVERSALE TIP
		Nr. plansa	PTC 51
Sef Proiect	Ing. A. Buta	Scara	1:100
Proiectat	Ing. A. Buta	Data	07/2023
Desenat	Ing. S. Patroi		
Verificat			

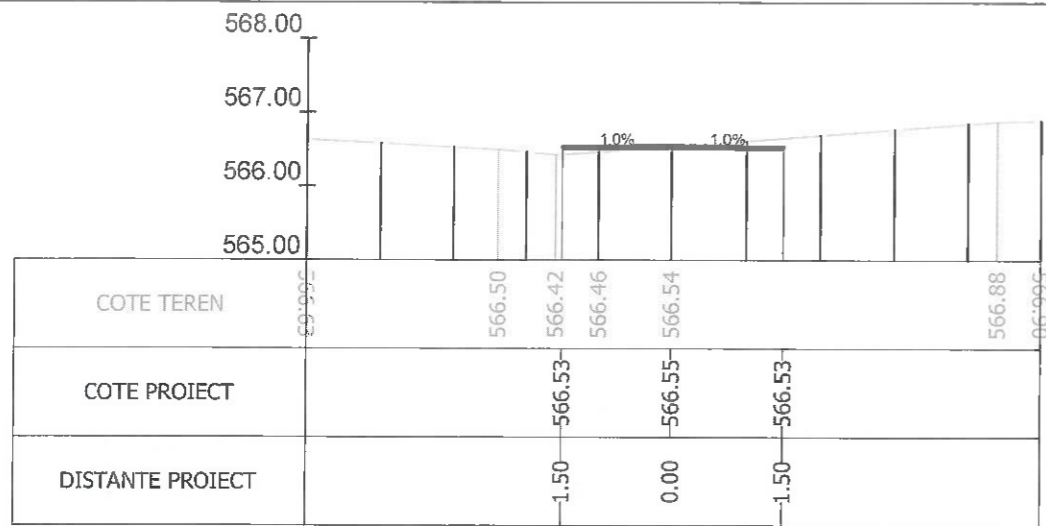

Sectiunea 417 - Km 5+675
Ax-Traseul 1

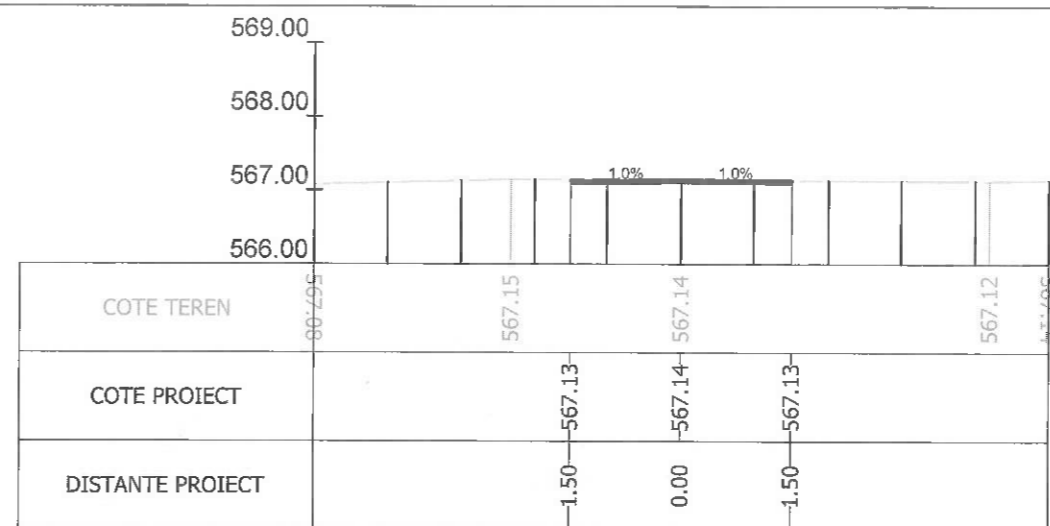

Sectiunea 418 - Km 5+700
Ax-Traseul 1

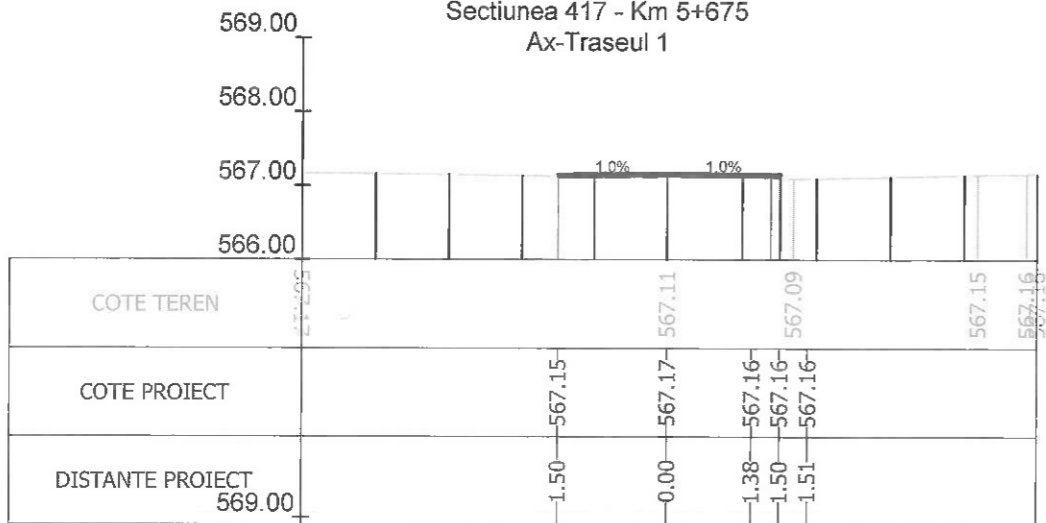

Sectiunea 419 - Km 5+702.329
Ax-Traseul 1

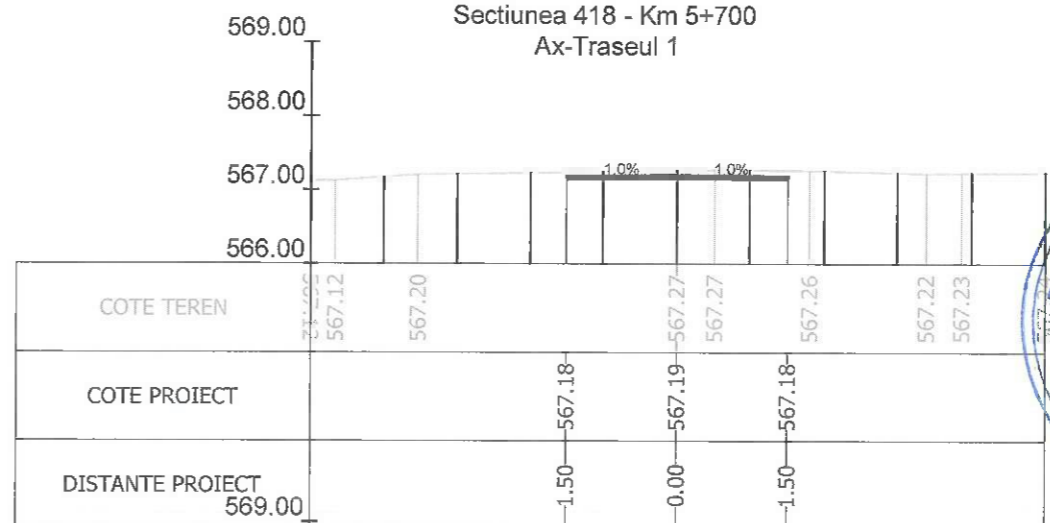

Sectiunea 420 - Km 5+716.877
Ax-Traseul 1

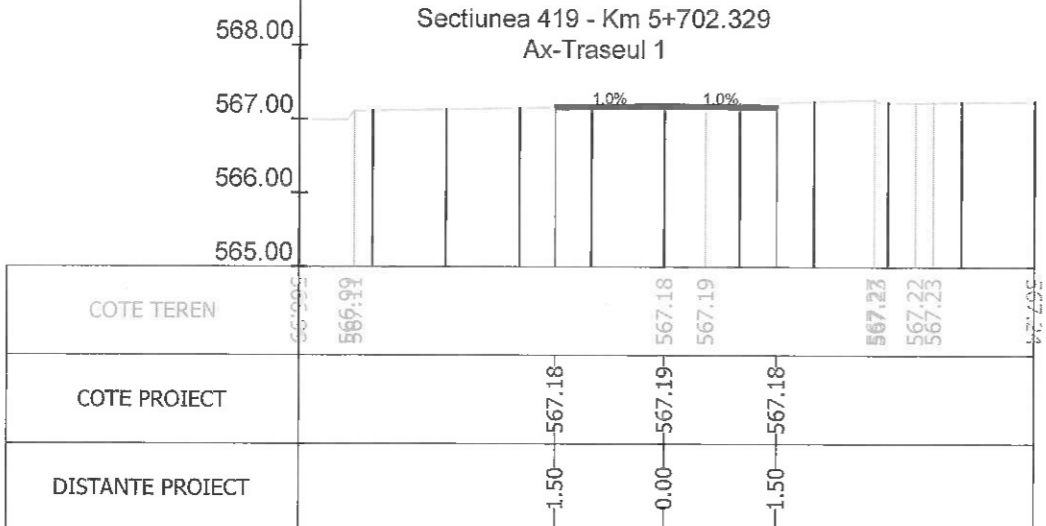

Sectiunea 421 - Km 5+720.086
Ax-Traseul 1

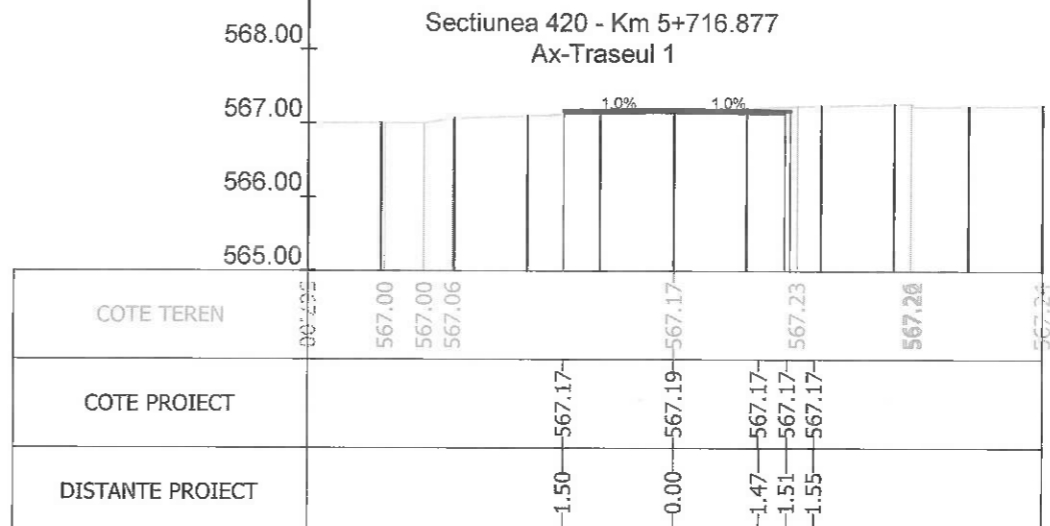

Sectiunea 422 - Km 5+723.296
Ax-Traseul 1

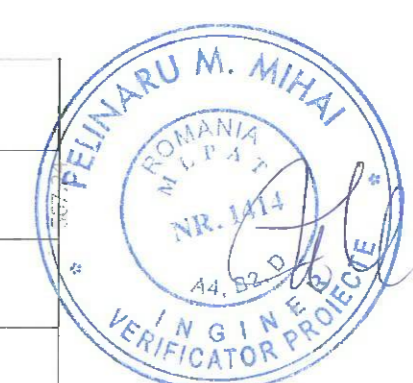

Index	Data	Observatii	Rev. 5
A			
		Beneficiar:	MUNICIPIUL BRASOV Bulevardul Eroilor 8, Brasov 500007
		Nr. proiect:	73 / 2020
Sediul: PIPRUT-LUNARI NR. 17 BIROU NR. 2 ETIAJ 4, VOLUNTARI LUDU, TEL: +40 37 415 24 49, EMAIL: OFFICE@HENTZA.RO www.hentza.ro		Titlu proiect:	INFRASTRUCTURA INTEGRATA PENTRU CICLISM SI TRAFIC PIETONAL CU FACILITATI COMPLEMENTARE - TRASEUL 1
Sef Proiect	Ing. A. Buta	Faza:	P.T.
Proiectat	Ing. A. Buta	Nr. plansa:	PTC 52
Desenat	Ing. S. Patroi	Titlu plansa:	PROFILURI TRANSVERSALE TIP
Verificat		Scara:	1:100
		Data:	07/2023

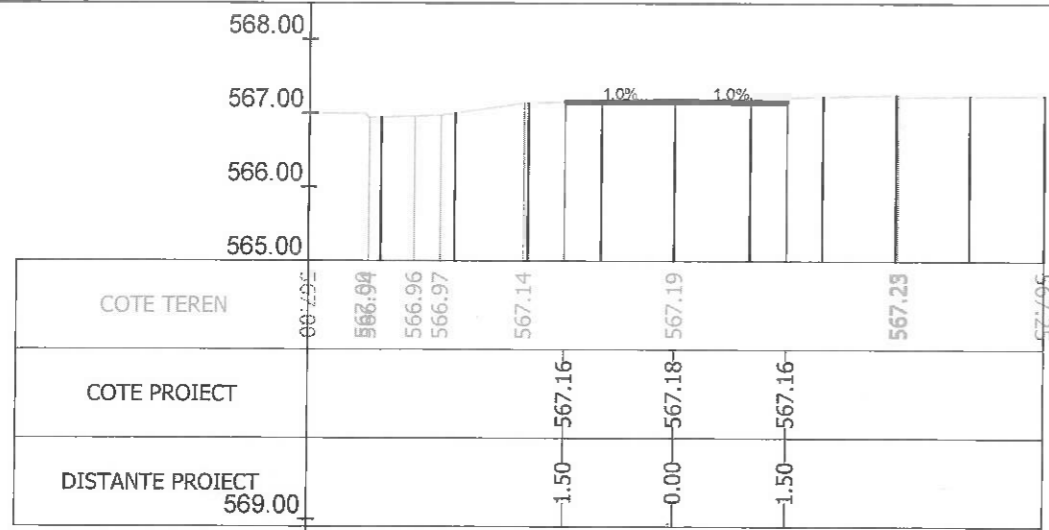

Sectiunea 423 - Km 5+725
Ax-Traseul 1

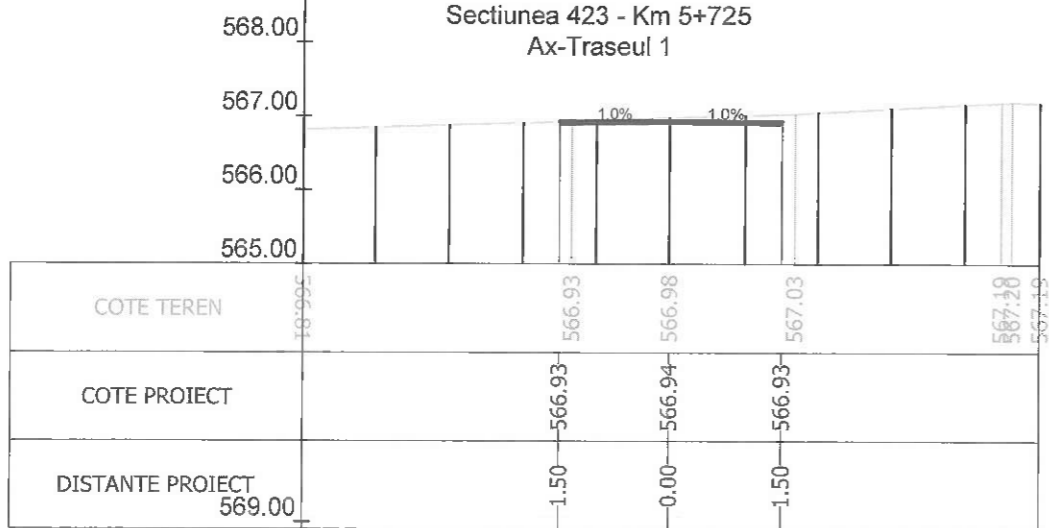

Sectiunea 424 - Km 5+737.538
Ax-Traseul 1

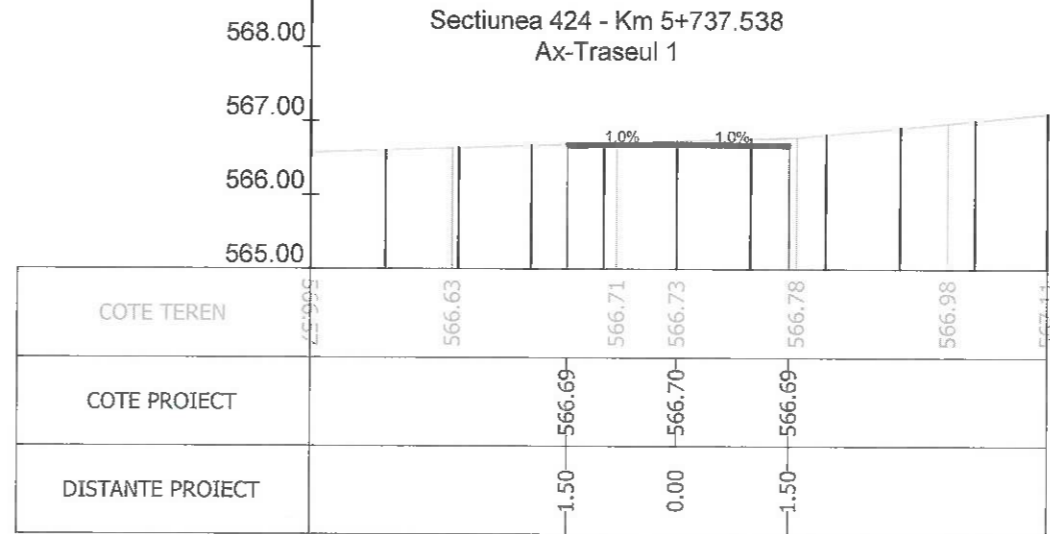

Sectiunea 425 - Km 5+750
Ax-Traseul 1

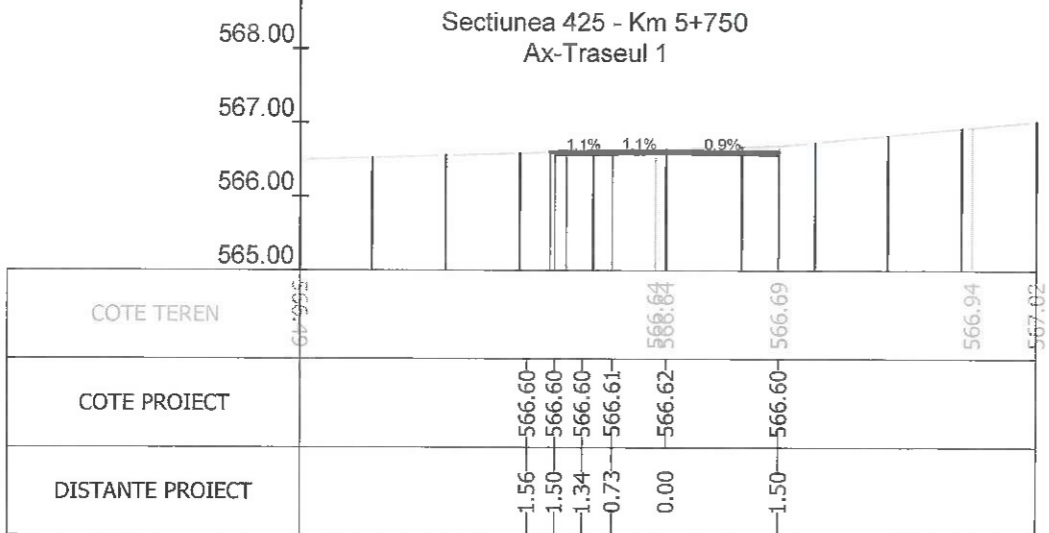

Sectiunea 426 - Km 5+775
Ax-Traseul 1

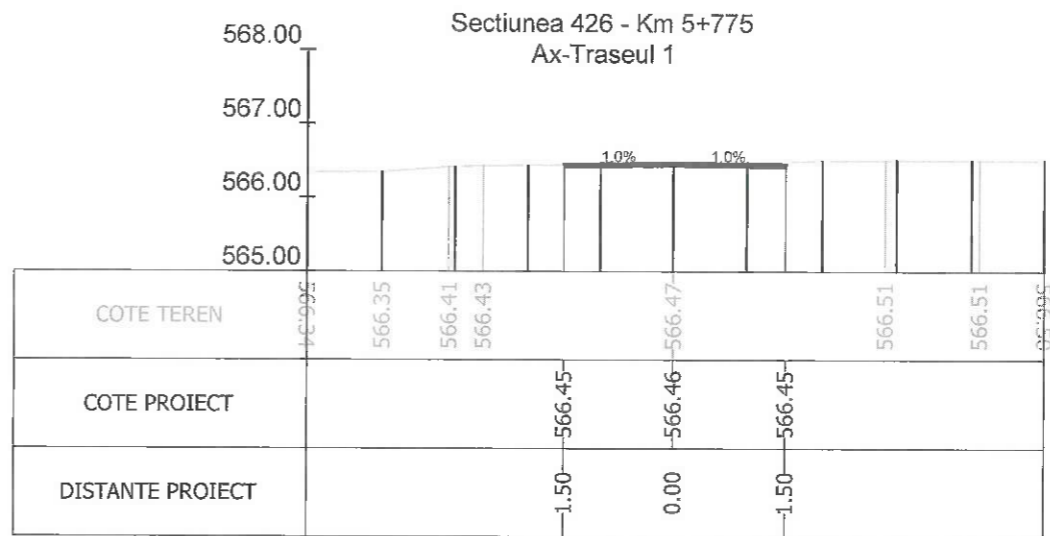

Sectiunea 428 - Km 5+800
Ax-Traseul 1



Sectiunea 427 - Km 5+783.878
Ax-Traseul 1

Index	Data	Observatii	Rev. 5
A			
		Beneficiar:	MUNICIPIUL BRASOV Bulevardul Eroilor 8, Brasov 500007
		Nr. proiect	73 / 2020
		Titlu proiect:	INFRASTRUCTURA INTEGRATA PENTRU CICLISM SI TRAFIC PIETONAL CU FACILITATI COMPLEMENTARE - TRASEUL 1
		Faza	P.T.
		Titlu plansa:	PROFILURI TRANSVERSALE TIP
		Nr. plansa	PTC 53
Sef Proiect	Ing. A. Buta	Scara	1:100
Proiectat	Ing. A. Buta	Data	07/2023
Desenat	Ing. S. Patroi		
Verificat			

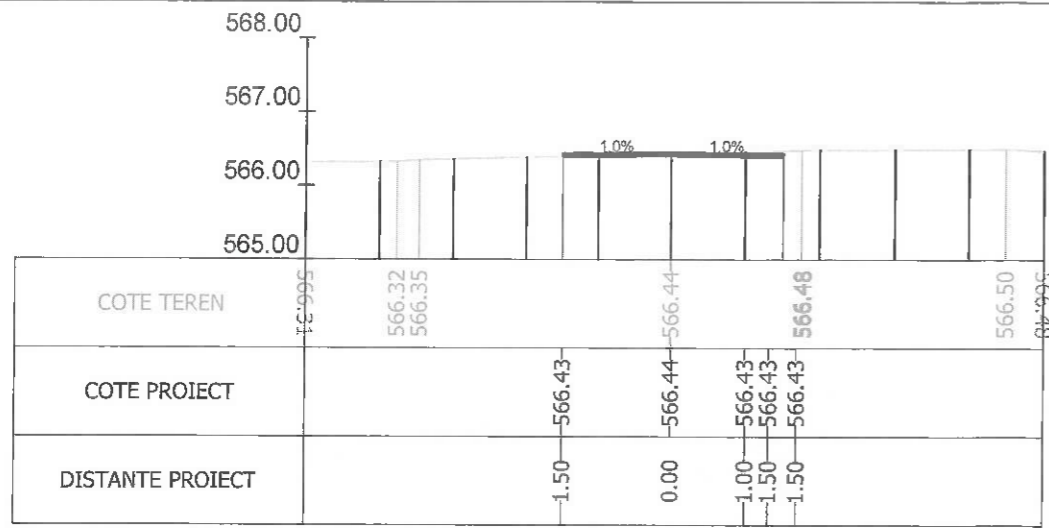

Sectiunea 429 - Km 5+802.907
Ax-Traseul 1

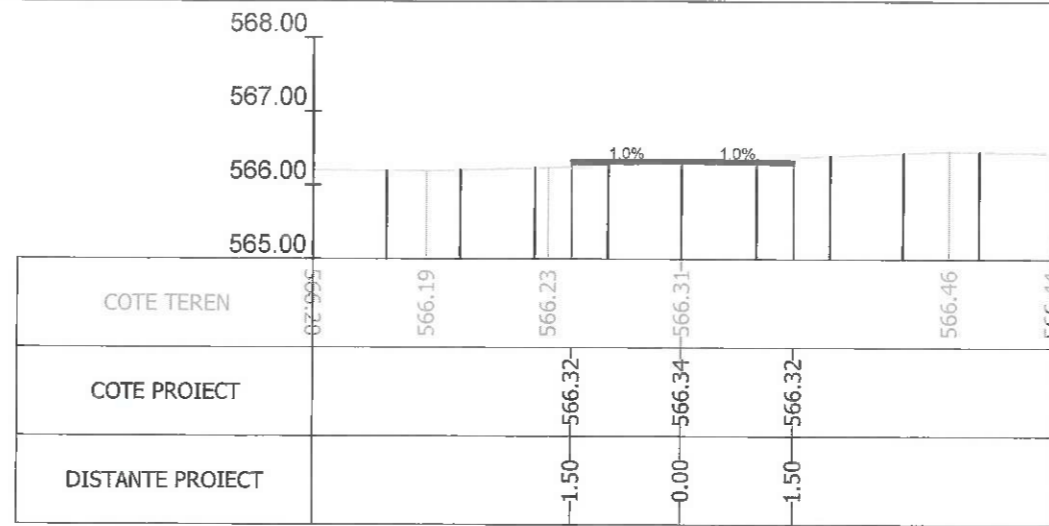

Sectiunea 430 - Km 5+818.635
Ax-Traseul 1

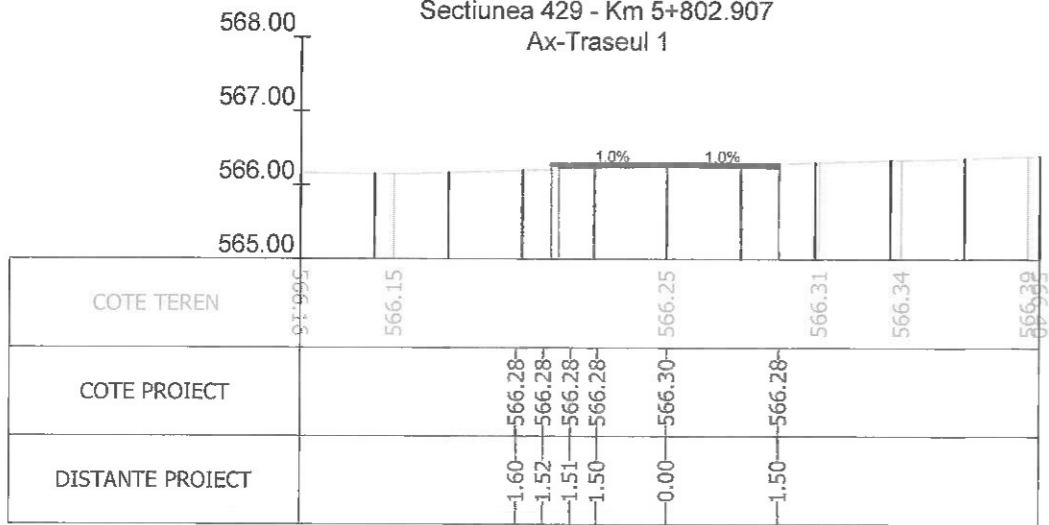

Sectiunea 431 - Km 5+825
Ax-Traseul 1

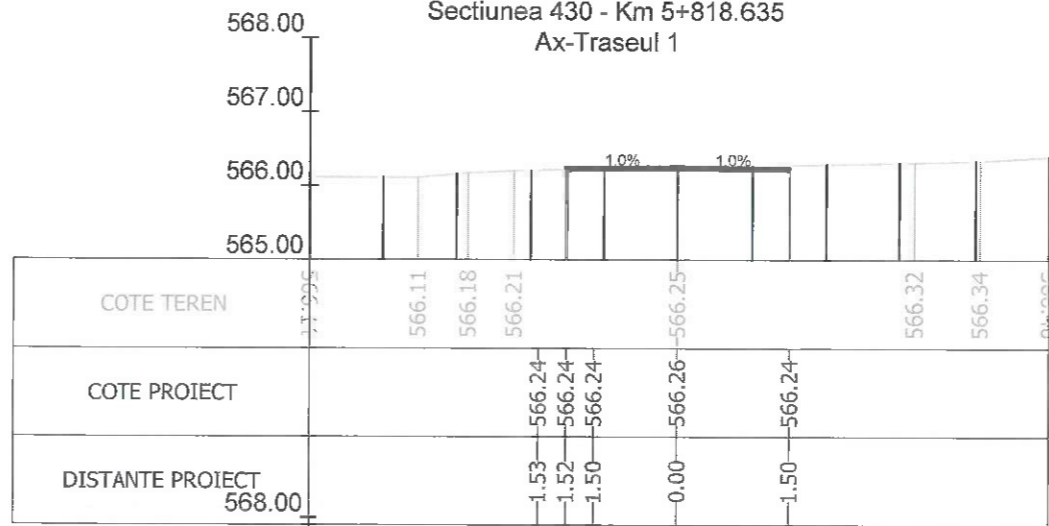

Sectiunea 432 - Km 5+830.770
Ax-Traseul 1

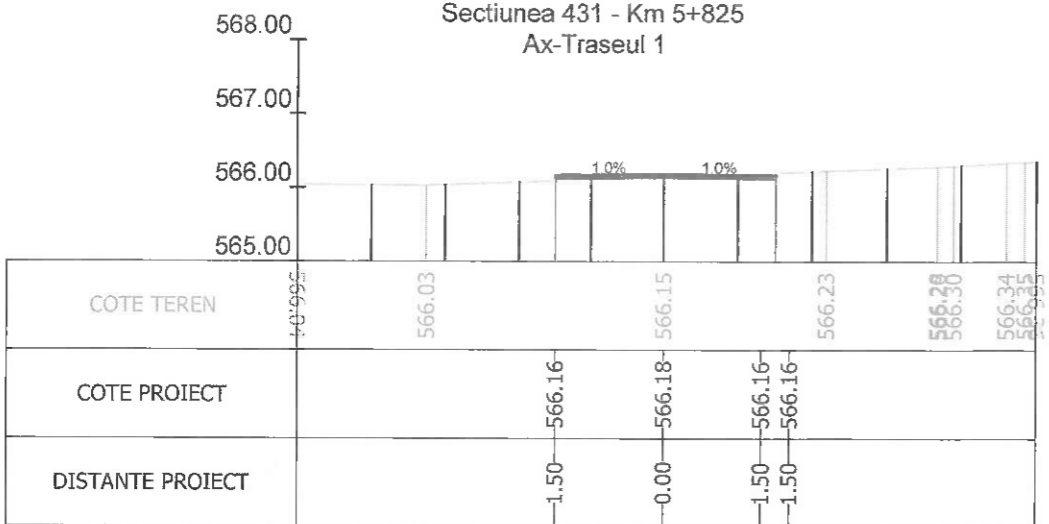

Sectiunea 433 - Km 5+842.904
Ax-Traseul 1

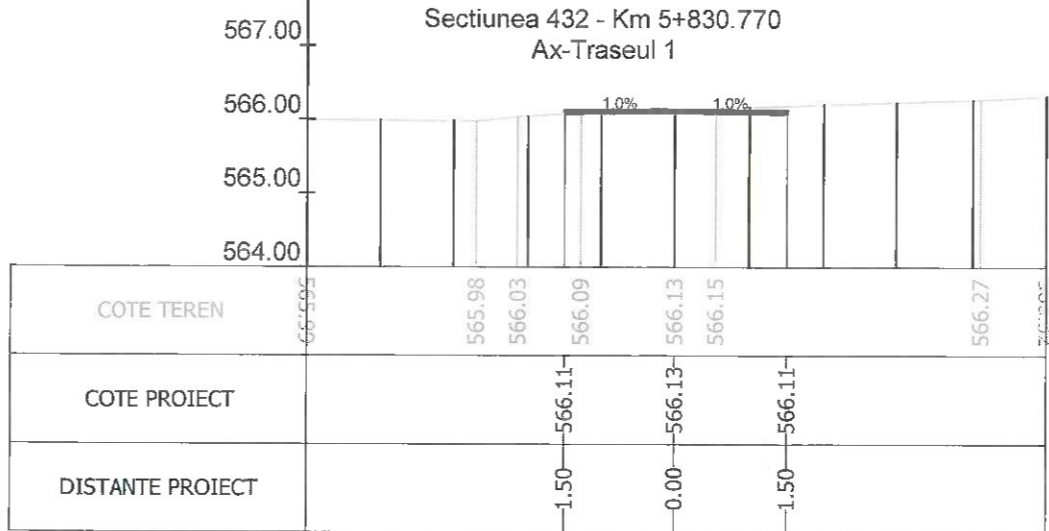

Sectiunea 434 - Km 5+850
Ax-Traseul 1

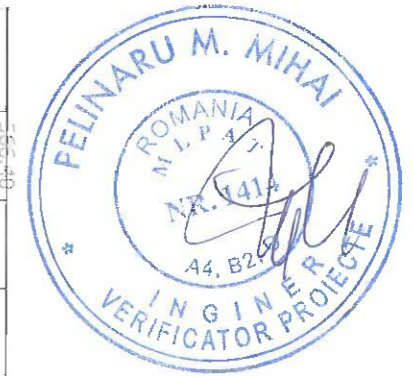

Index	Data	Observatii	Rev. 5
A			
		Beneficiar:	MUNICIPIUL BRASOV Bulevardul Eroilor 8, Brasov 500007
		Nr. proiect	73 / 2020
Sef Proiect: Ing. A. Buta Proiectat: Ing. A. Buta Desenat: Ing. S. Patroi Verificat:		Titlu proiect:	INFRASTRUCTURA INTEGRATA PENTRU CICLISM SI TRAFIC PIETONAL CU FACILITATI COMPLEMENTARE - TRASEUL 1
Scara: 1:100 Data: 07/2023		Titlu plansa:	PROFILURI TRANSVERSALE TIP
		Nr. plansa	PTC 54

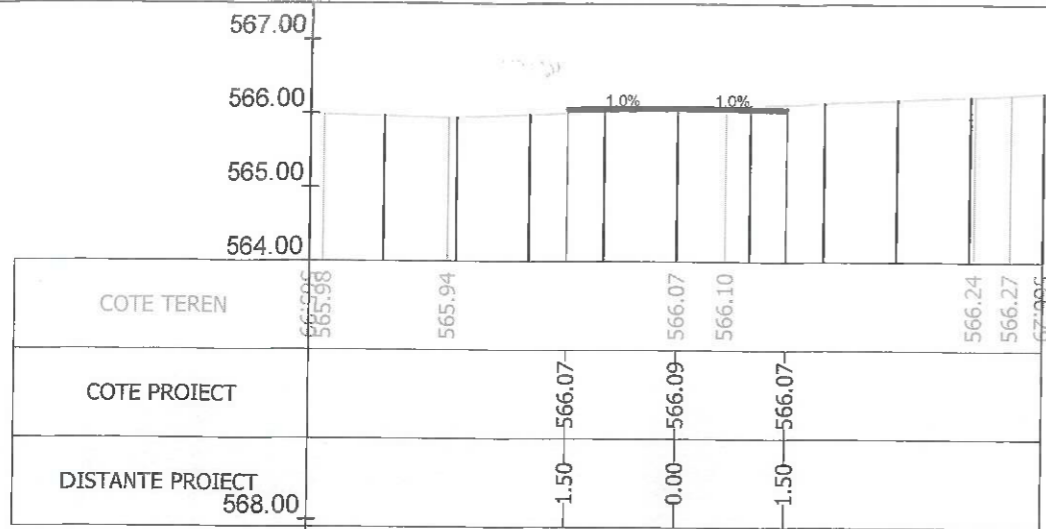

Sectiunea 435 - Km 5+856.096
Ax-Traseul 1

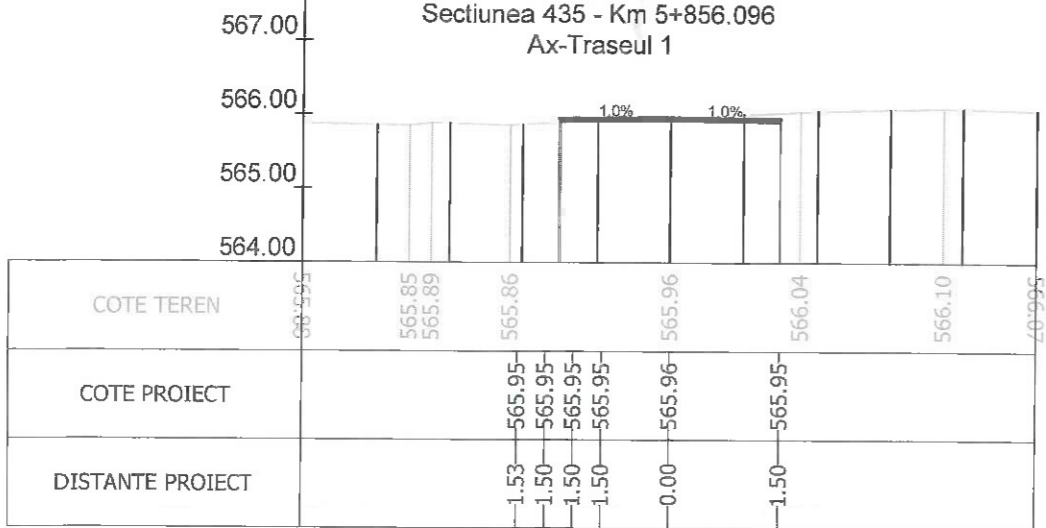

Sectiunea 436 - Km 5+874.474
Ax-Traseul 1

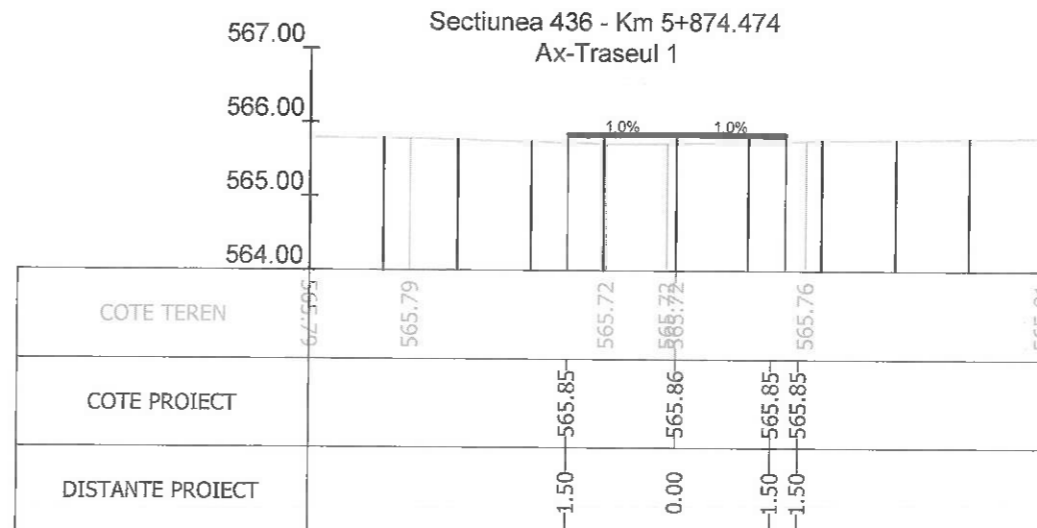

Sectiunea 437 - Km 5+875
Ax-Traseul 1

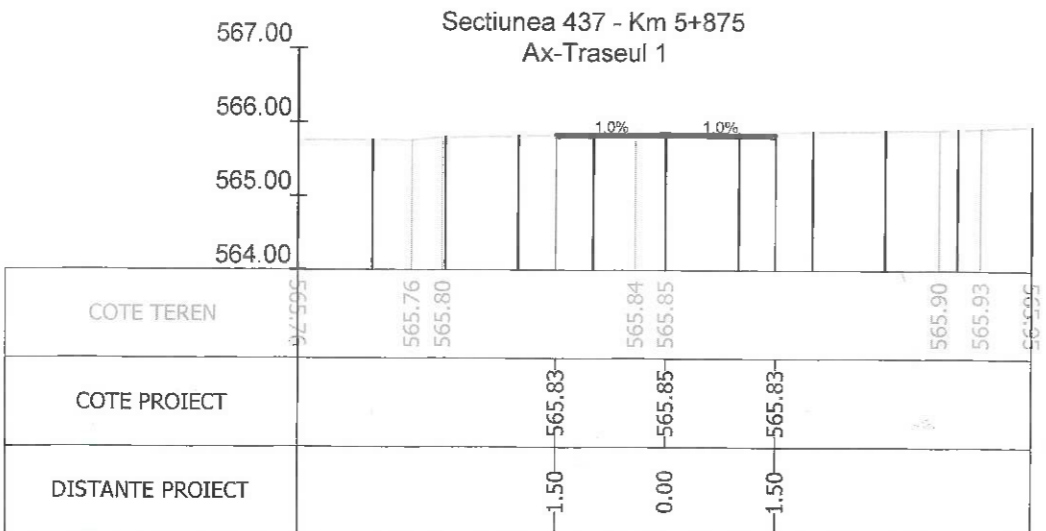

Sectiunea 438 - Km 5+892.852
Ax-Traseul 1

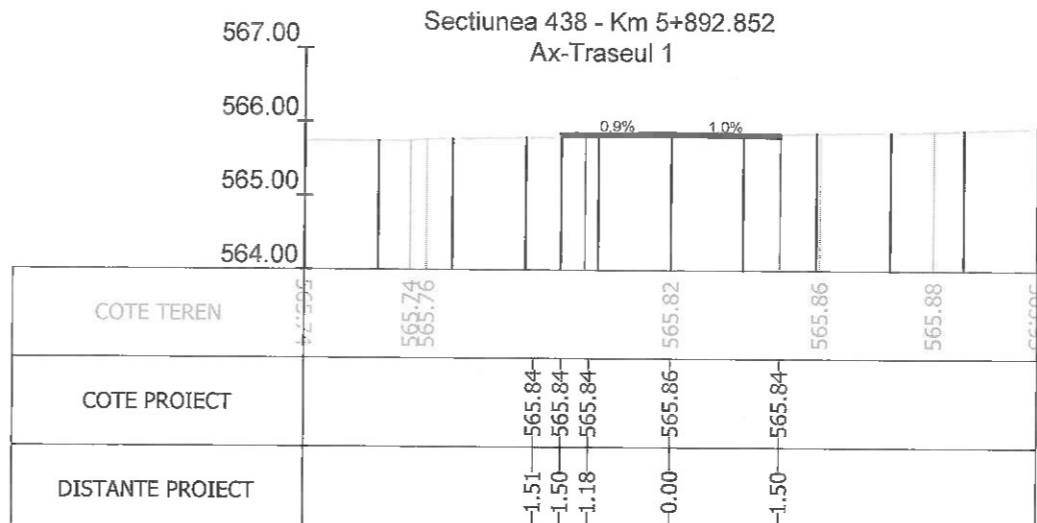

Sectiunea 439 - Km 5+900
Ax-Traseul 1

Sectiunea 440 - Km 5+901.708
Ax-Traseul 1



Index	Data	Observatii	Rev. 5
A			
		Beneficiar:	MUNICIPIUL BRASOV Bulevardul Eroilor 8, Brasov 500007
		Nr. proiect	73 / 2020
		Titlu proiect:	INFRASTRUCTURA INTEGRATA PENTRU CICLISM SI TRAFIC PIETONAL CU FACILITATI COMPLEMENTARE - TRASEUL 1
		Faza	P.T.
		Titlu plansa:	PROFILURI TRANSVERSALE TIP
		Nr. plansa	PTC 55
Sef Proiect	Ing. A. Buta	Scara	1:100
Proiectat	Ing. A. Buta	Data	07/2023
Desenat	Ing. S. Patroi		
Verificat			

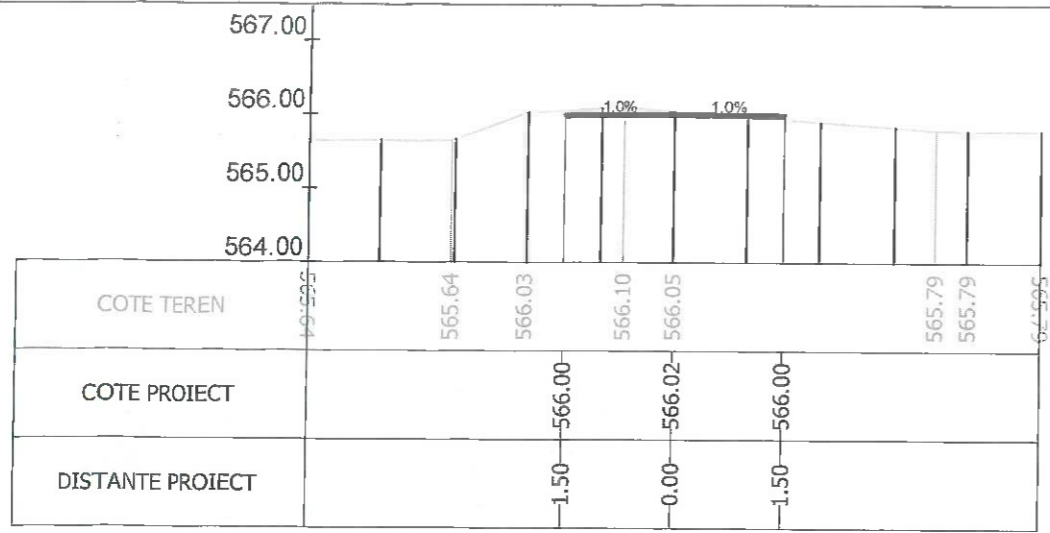

Sectiunea 441 - Km 5+925
Ax-Traseul 1

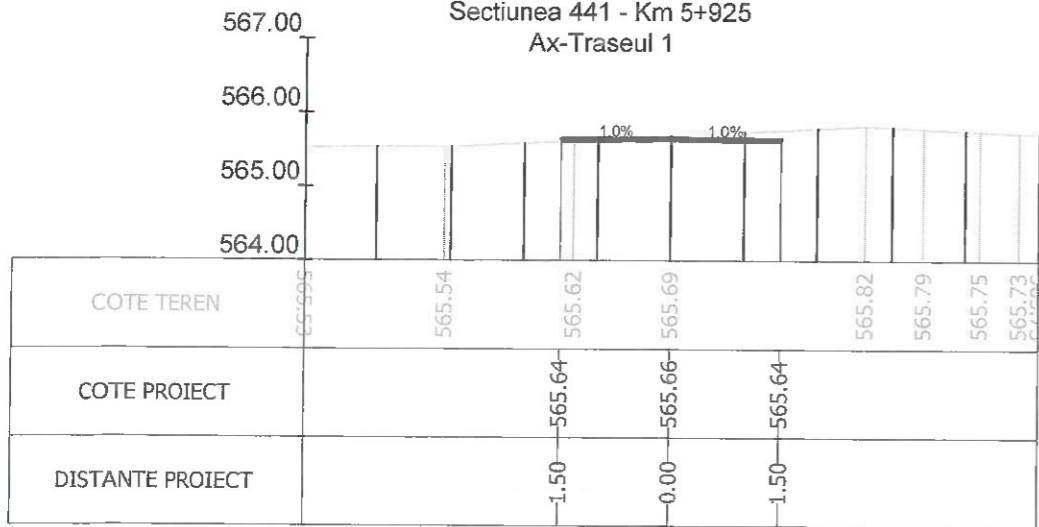

Sectiunea 442 - Km 5+950
Ax-Traseul 1

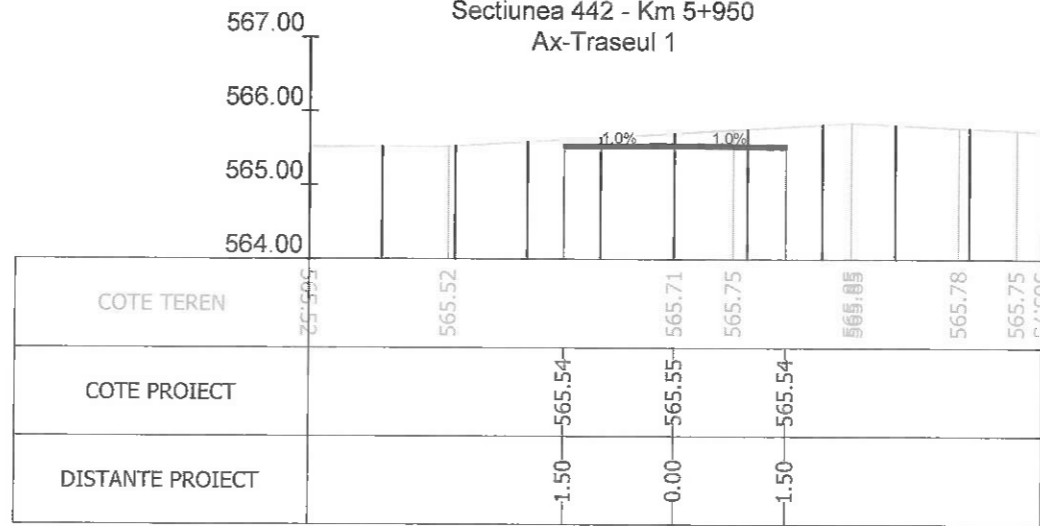

Sectiunea 443 - Km 5+975
Ax-Traseul 1

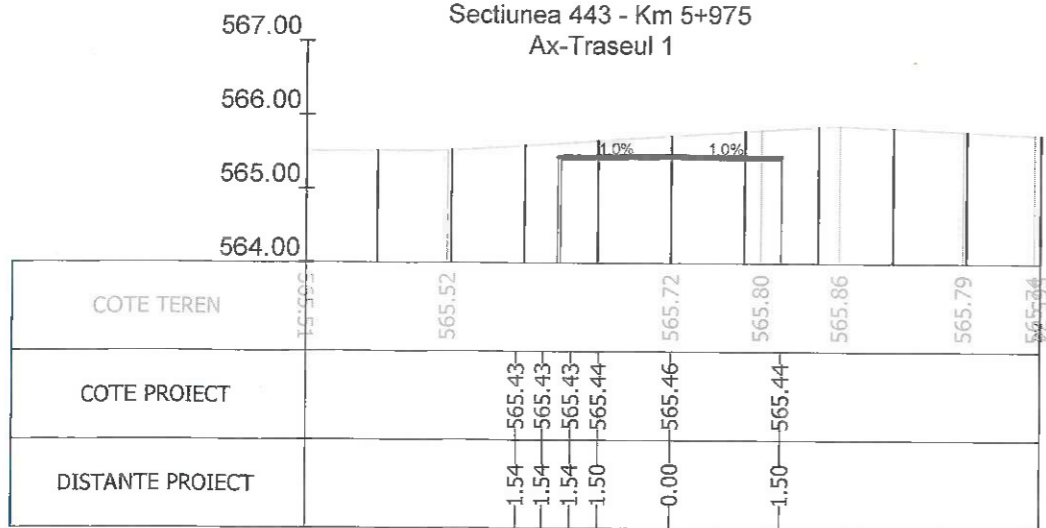

Sectiunea 444 - Km 5+980.958
Ax-Traseul 1

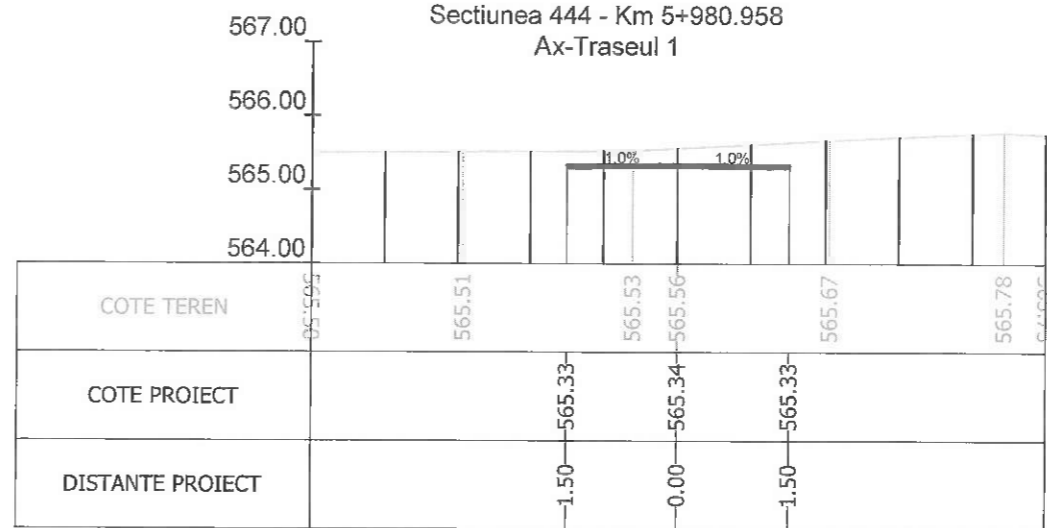

Sectiunea 445 - Km 5+984.529
Ax-Traseul 1

Sectiunea 446 - Km 5+988.100
Ax-Traseul 1



Index	Data	Observatii	Rev. 5
A			
		Beneficiar:	MUNICIPIUL BRASOV Bulevardul Eroilor 8, Brasov 500007
		Nr. proiect	73 / 2020
		Titlu proiect:	INFRASTRUCTURA INTEGRATA PENTRU CICLISM SI TRAFIC PIETONAL CU FACILITATI COMPLEMENTARE - TRASEUL 1
		Faza	P.T.
		Titlu plansa:	PROFILURI TRANSVERSALE TIP
		Nr. plansa	PTC 56
Sef Proiect	Ing. A. Buta	Scara	1:100
Proiectat	Ing. A. Buta	Data	07/2023
Desenat	Ing. S. Patroi		
Verificat			

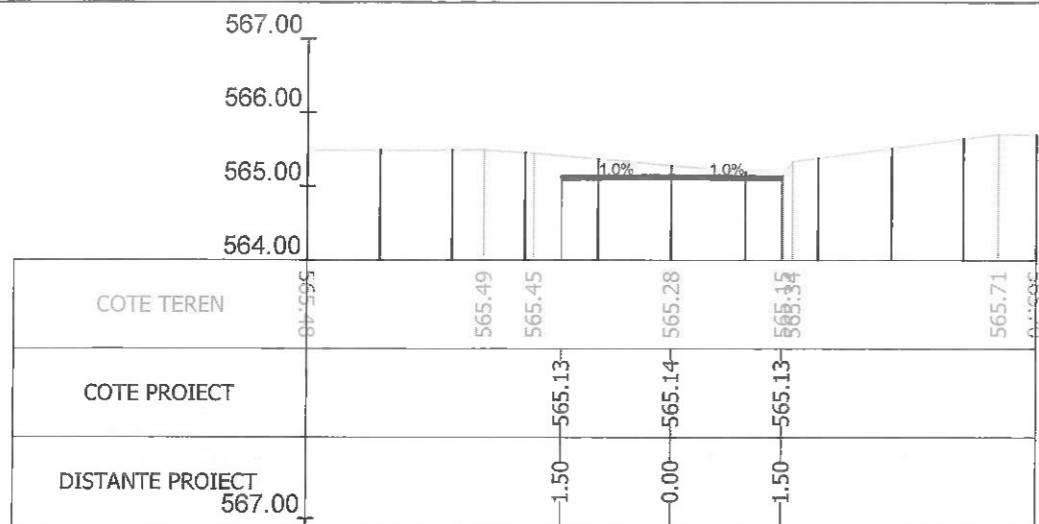

Sectiunea 447 - Km 5+995.821
Ax-Traseul 1

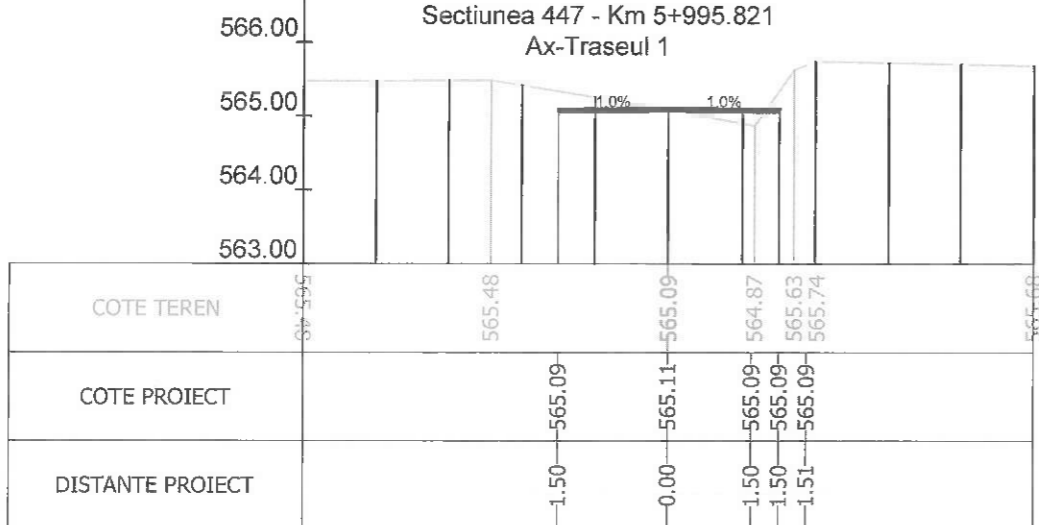

Sectiunea 448 - Km 5+998.856
Ax-Traseul 1

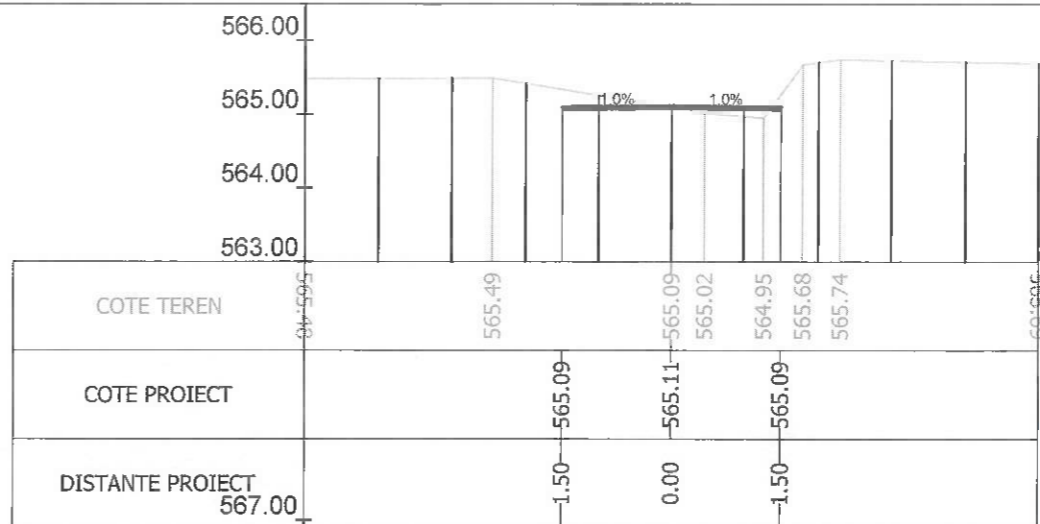

Sectiunea 449 - Km 6+000
Ax-Traseul 1

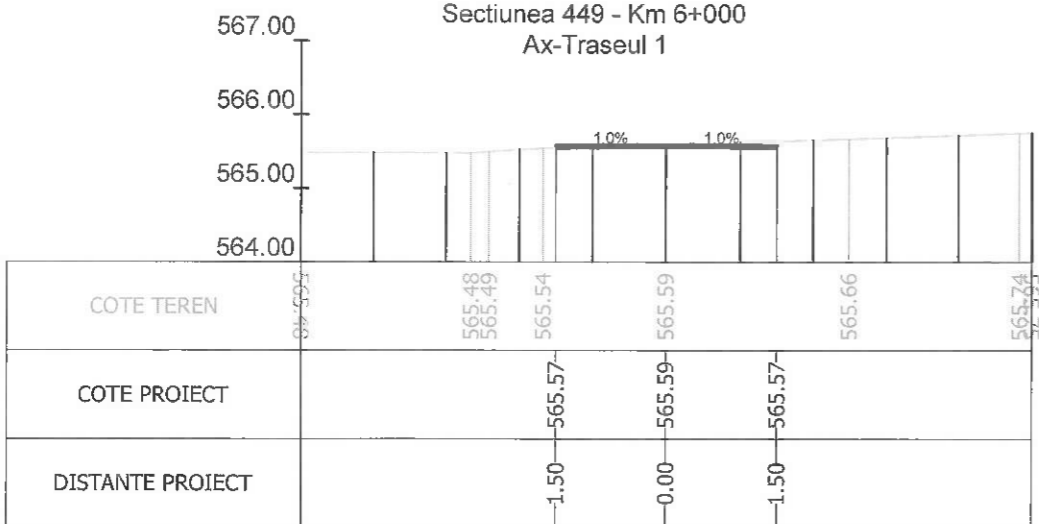

Sectiunea 450 - Km 6+001.891
Ax-Traseul 1

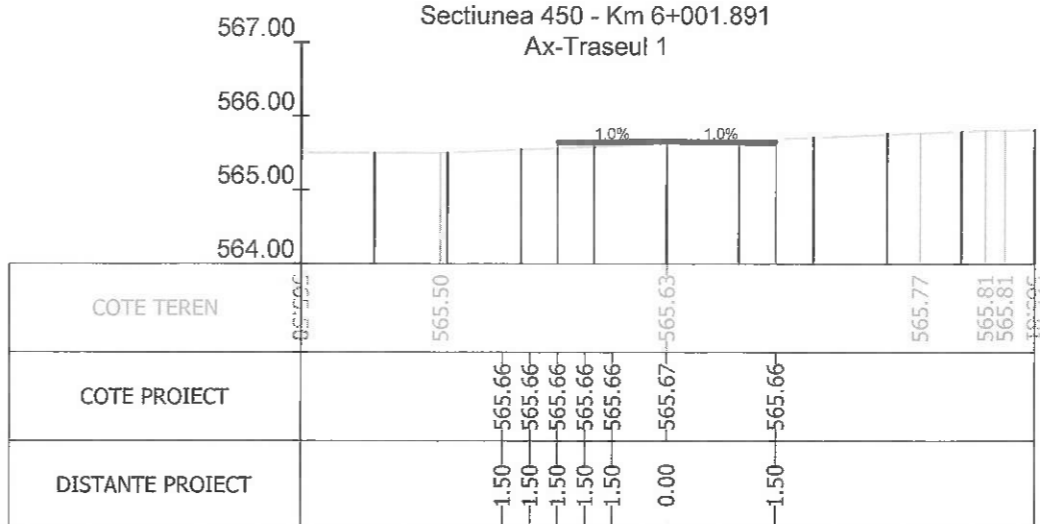

Sectiunea 451 - Km 6+025
Ax-Traseul 1

Sectiunea 452 - Km 6+034.072
Ax-Traseul 1



Index	Data	Observatii	Rev. 5
A			
		Beneficiar:	MUNICIPIUL BRASOV Bulevardul Eroilor 8, Brasov 500007
		Nr. proiect	73 / 2020
		Titlu proiect:	INFRASTRUCTURA INTEGRATA PENTRU CICLISM SI TRAFIC PIETONAL CU FACILITATI COMPLEMENTARE - TRASEUL 1
		Faza	P.T.
		Titlu planşa:	PROFILURI TRANSVERSALE TIP
		Nr. planşa	PTC 57
Sef Proiect	Ing. A. Buta	Scara	1:100
Proiectat	Ing. A. Buta	Data	07/2023
Desenat	Ing. S. Patroi		
Verificat			

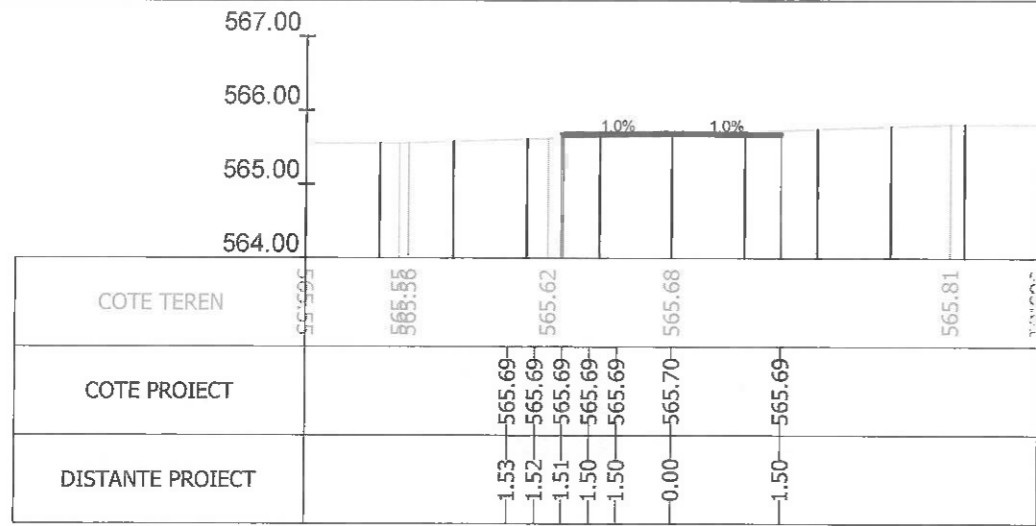

Sectiunea 453 - Km 6+050
Ax-Traseul 1

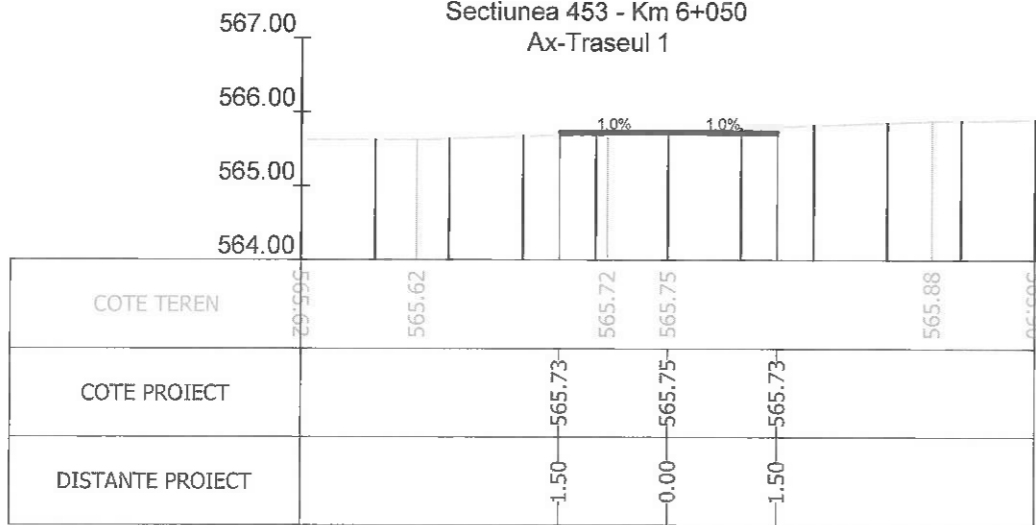

Sectiunea 454 - Km 6+066.253
Ax-Traseul 1

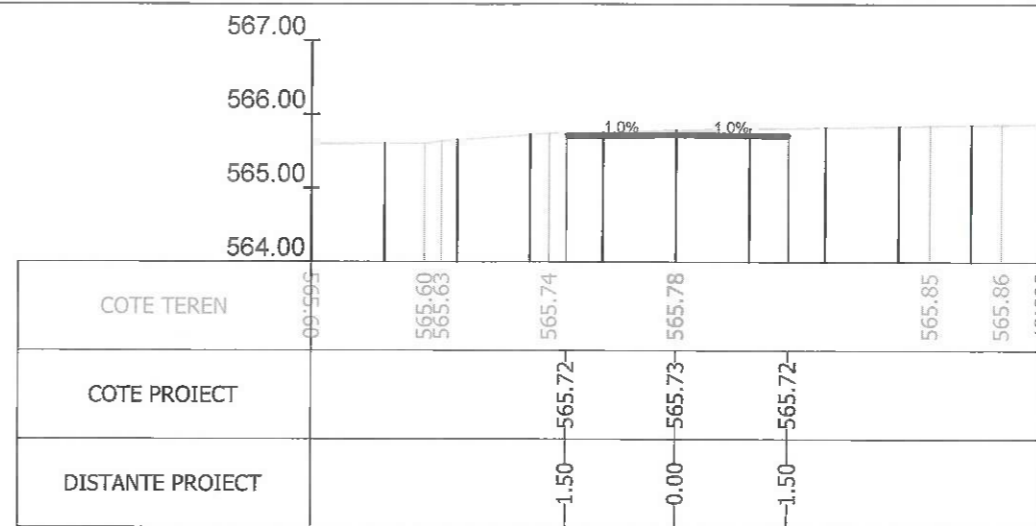

Sectiunea 455 - Km 6+075
Ax-Traseul 1

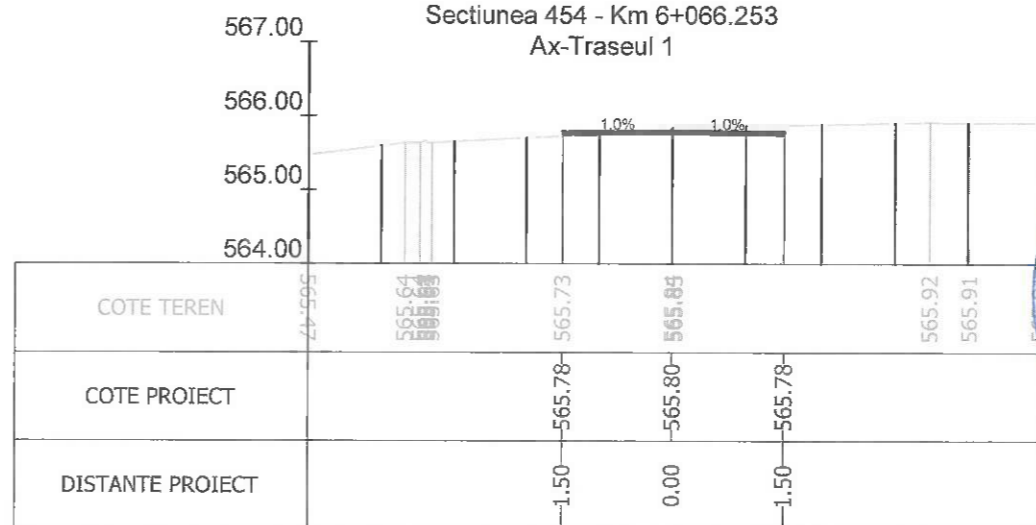

Sectiunea 456 - Km 6+091.151
Ax-Traseul 1

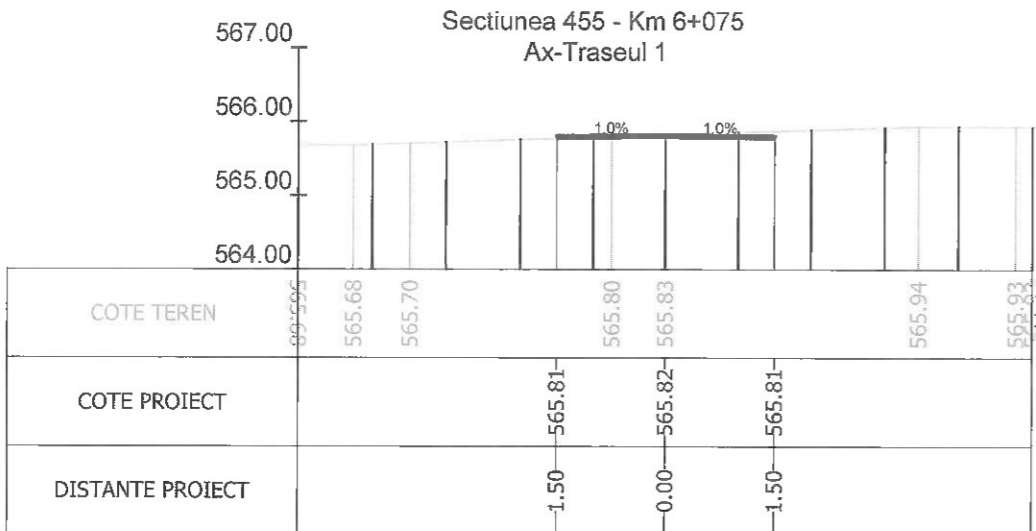

Sectiunea 457 - Km 6+100
Ax-Traseul 1

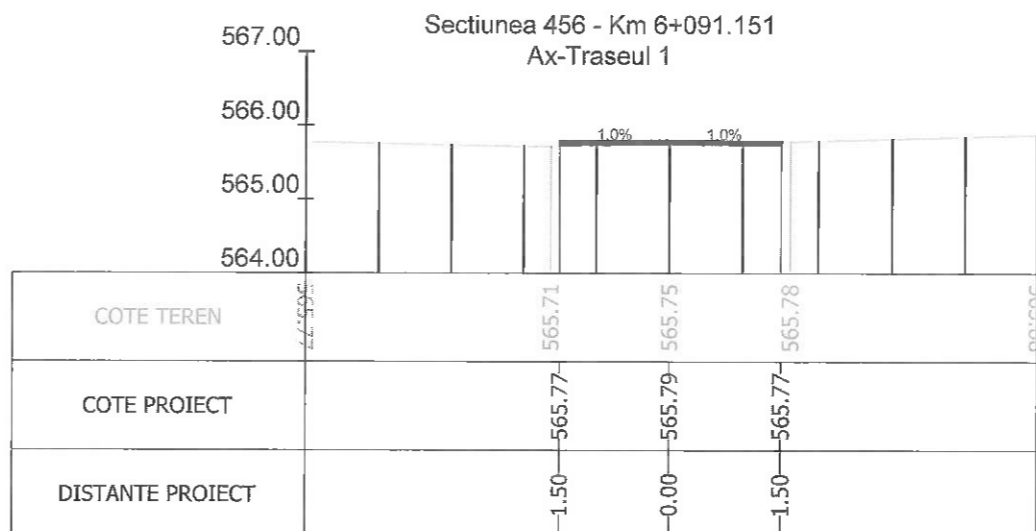

Sectiunea 458 - Km 6+115.208
Ax-Traseul 1

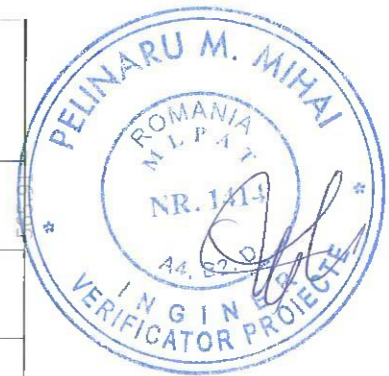

Index	Data	Observatii	Rev. 5
A			
		Beneficiar:	MUNICIPIUL BRASOV Bulevardul Eroilor 8, Brasov 500007
		Nr. proiect	73 / 2020
		Titlu proiect:	INFRASTRUCTURA INTEGRATA PENTRU CICLISM SI TRAFIC PIETONAL CU FACILITATI COMPLEMENTARE - TRASEUL 1
		Faza	P.T.
		Titlu plansa:	PROFILURI TRANSVERSALE TIP
		Nr. plansa	PTC 58
Sef Proiect	Ing. A. Buta	Scara	1:100
Proiectant	Ing. A. Buta	Data	07/2023
Desenat	Ing. S. Patroi		
Verificat			

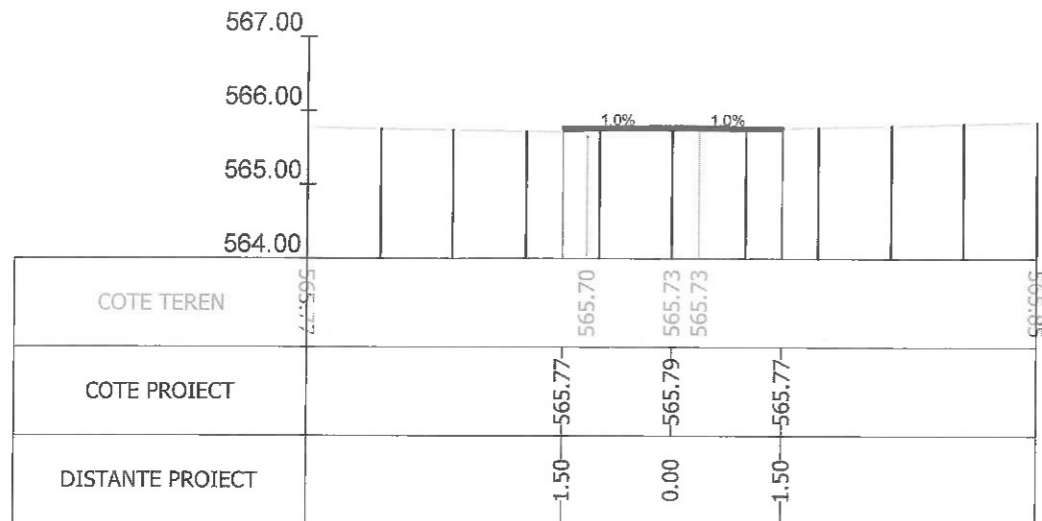

Sectiunea 459 - Km 6+116.317
Ax-Traseul 1

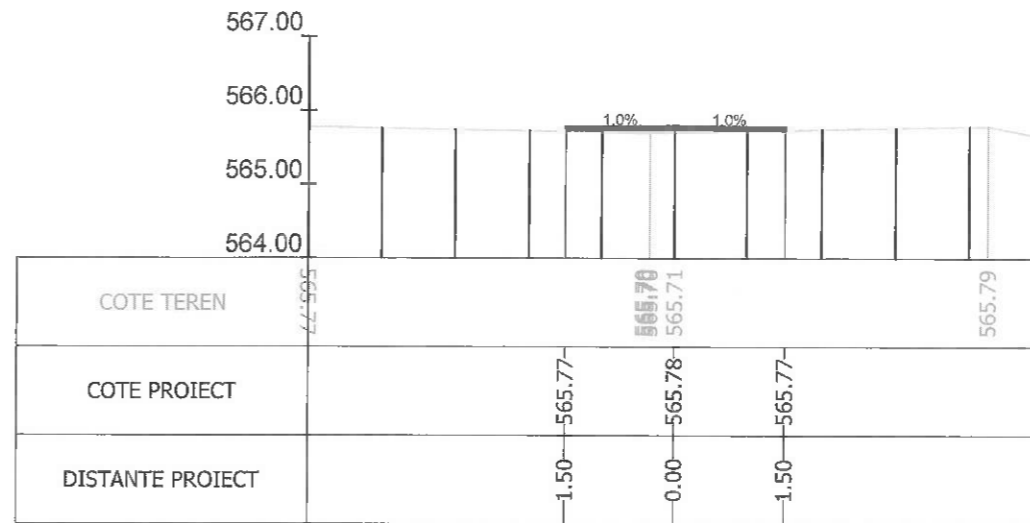

Sectiunea 460 - Km 6+117.427
Ax-Traseul 1

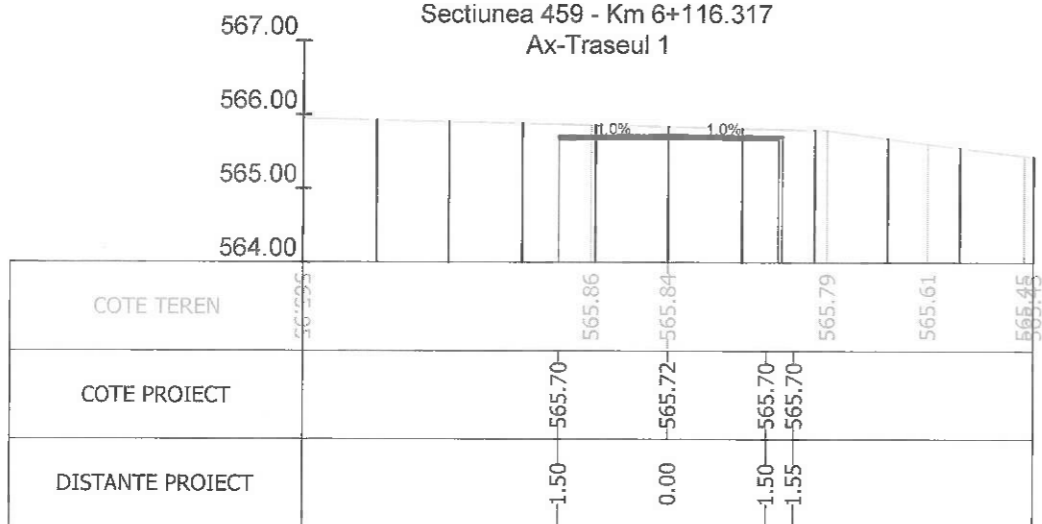

Sectiunea 465 - Km 6+132.543
Ax-Traseul 1

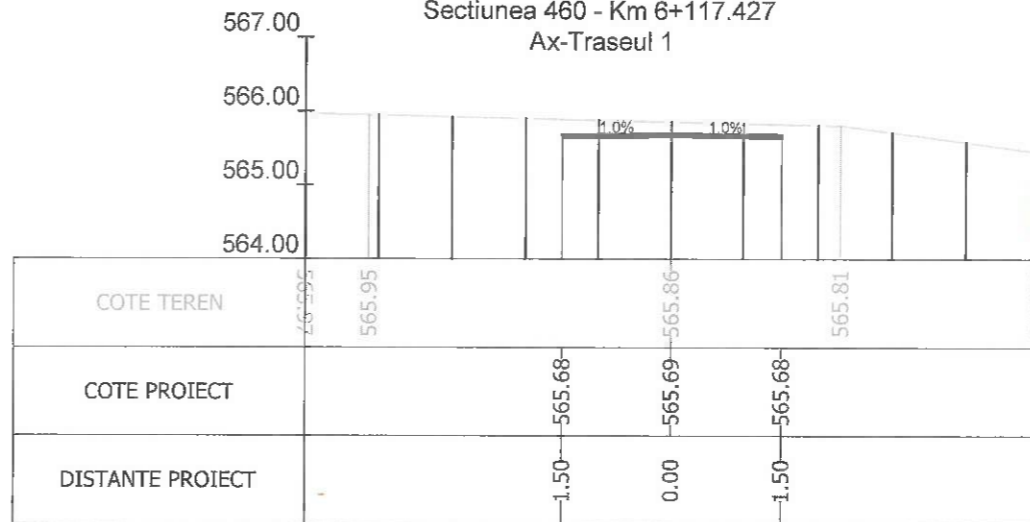

Sectiunea 466 - Km 6+136.110
Ax-Traseul 1



Index	Data	Observatii	Rev. 5
A			
		Beneficiar:	MUNICIPIUL BRASOV Bulevardul Eroilor 8, Brasov 500007
		Nr. proiect	73 / 2020
		Titlu proiect:	INFRASTRUCTURA INTEGRATA PENTRU CICLISM SI TRAFIC PIETONAL CU FACILITATI COMPLEMENTARE - TRASEUL 1
		Faza	P.T.
		Titlu plansa:	PROFILURI TRANSVERSALE TIP
		Nr. plansa	PTC 59
Sef Proiect	Ing. A. Buta	Scara	1:100
Proiectat	Ing. A. Buta	Data	07/2023
Desenat	Ing. S. Patroi		
Verificat			

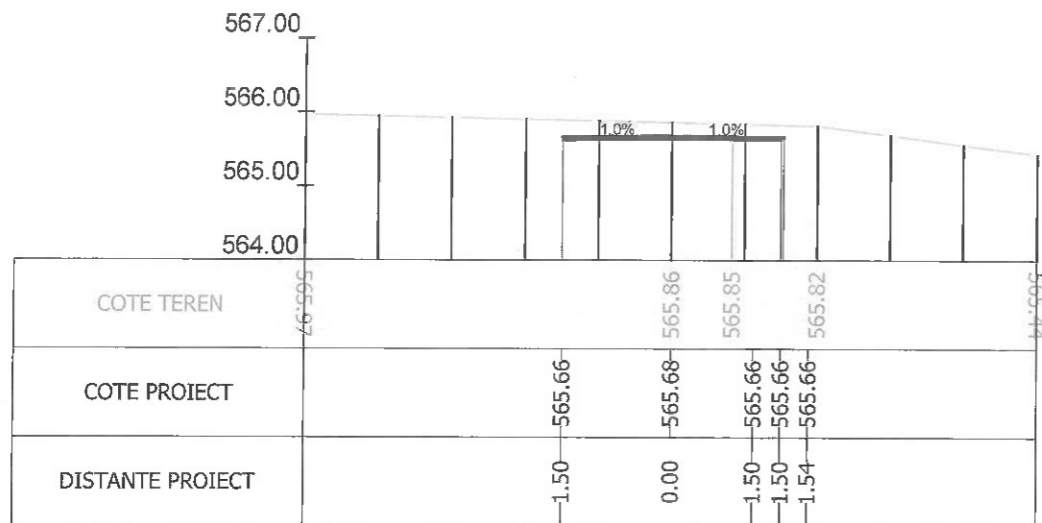

Sectiunea 467 - Km 6+138.881
Ax-Traseul 1

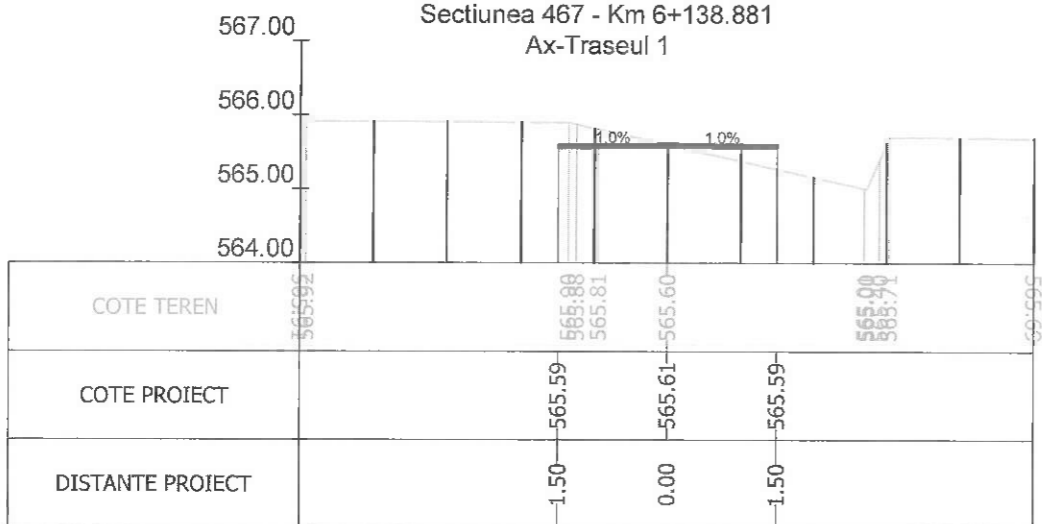

Sectiunea 469 - Km 6+150
Ax-Traseul 1

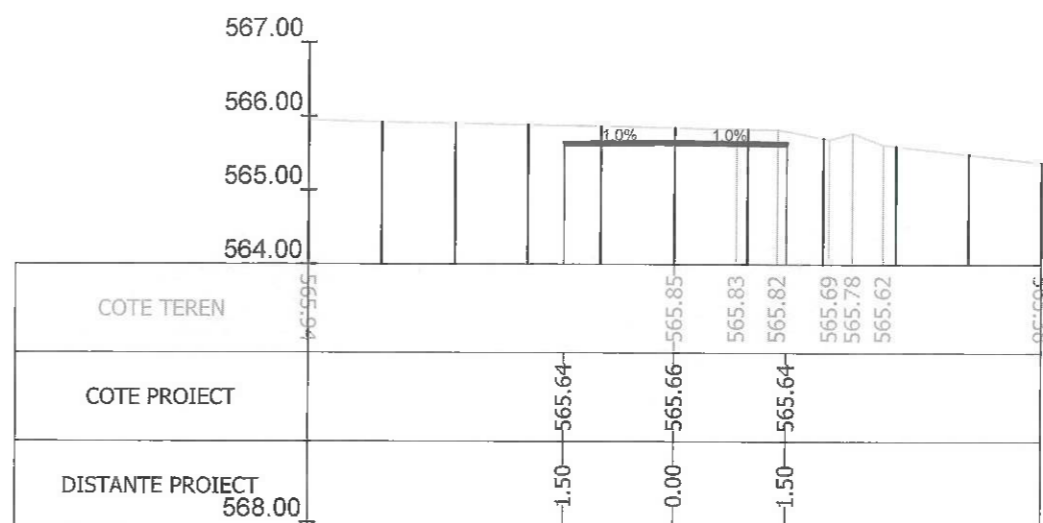

Sectiunea 468 - Km 6+141.651
Ax-Traseul 1

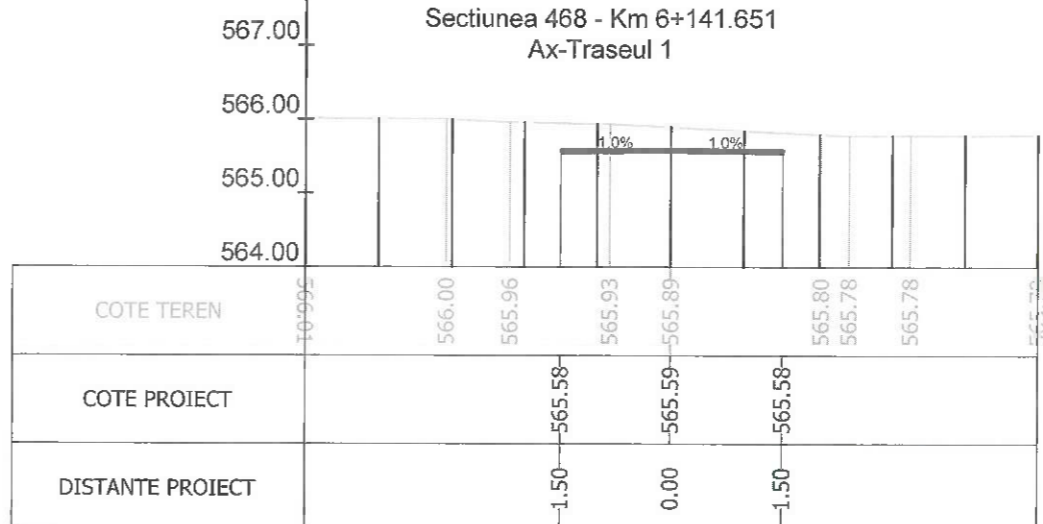

Sectiunea 470 - Km 6+152
Ax-Traseul 1

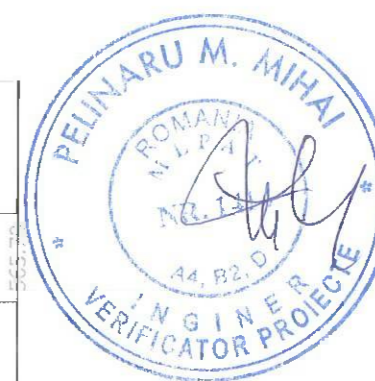

Index	Data	Observatii	Rev. 5
A			
		Beneficiar:	MUNICIPIUL BRASOV Bulevardul Eroilor 8, Brasov 500007
		Nr. proiect	73 / 2020
		Titlu proiect:	INFRASTRUCTURA INTEGRATA PENTRU CICLISM SI TRAFIC PIETONAL CU FACILITATI COMPLEMENTARE - TRASEUL 1
		Faza	P.T.
		Titlu plansa:	PROFILURI TRANSVERSALE TIP
		Nr. plansa	PTC 60
Sef Proiect	Ing. A. Buta	Scara	
Proiectat	Ing. A. Buta	1:100	
Desenat	Ing. S. Patroi	Data	
Verificat		07/2023	

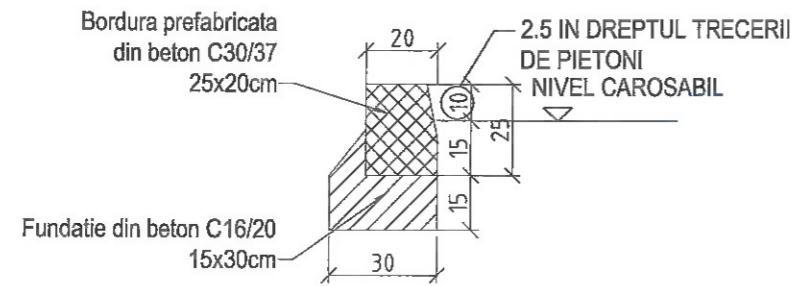

DETALII MONTARE BORDURI

BORDURA CAROSABIL sc. 1:20

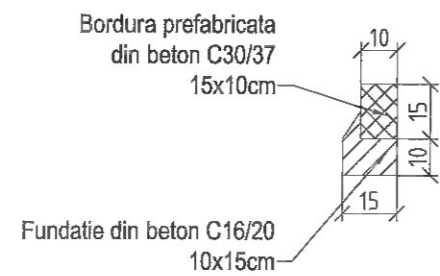

BORDURA TROTUAR sc. 1:20



Index	Data	Observatii	Rev. 5
A			
		Beneficiar:	MUNICIPIUL BRASOV Bulevardul Eroilor 8, Brasov 500007
		Nr. proiect:	73 / 2020
Sef Proiect: Ing. A. Buta Proiectat: Ing. A. Buta Desenat: Ing. S. Patroi Verificat:		Titlu proiect:	INFRASTRUCTURA INTEGRATA PENTRU CICLISM SI TRAFIC PIETONAL CU FACILITATI COMPLEMENTARE - TRASEUL 1
Scara: 1/20 Data: 07/2023		Titlu plansa:	DETALII MONTARE BORDURI
		Nr. plansa:	D-01

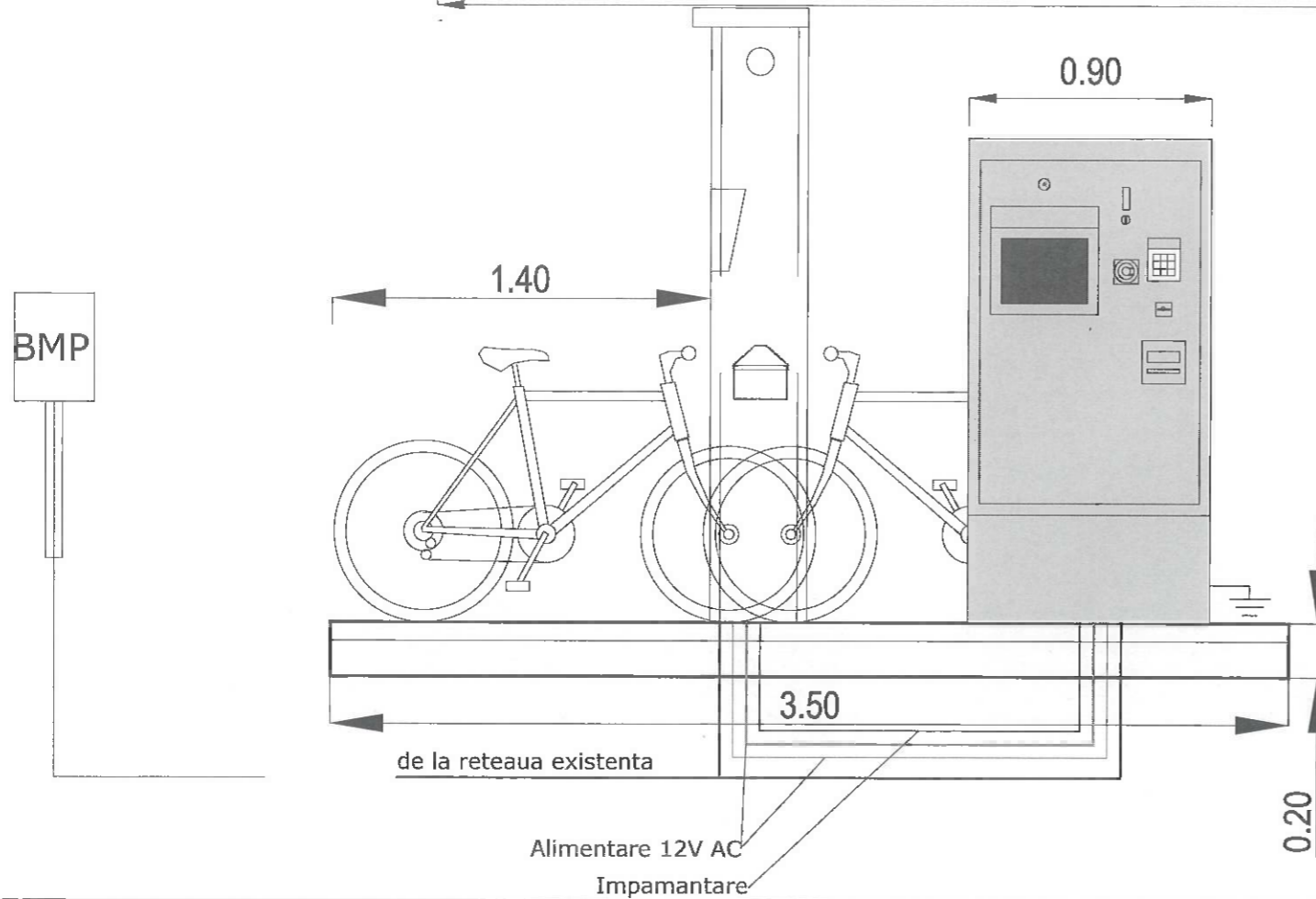
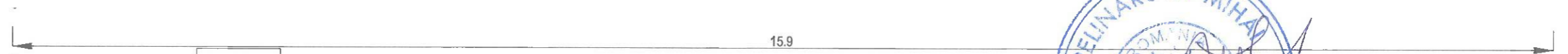
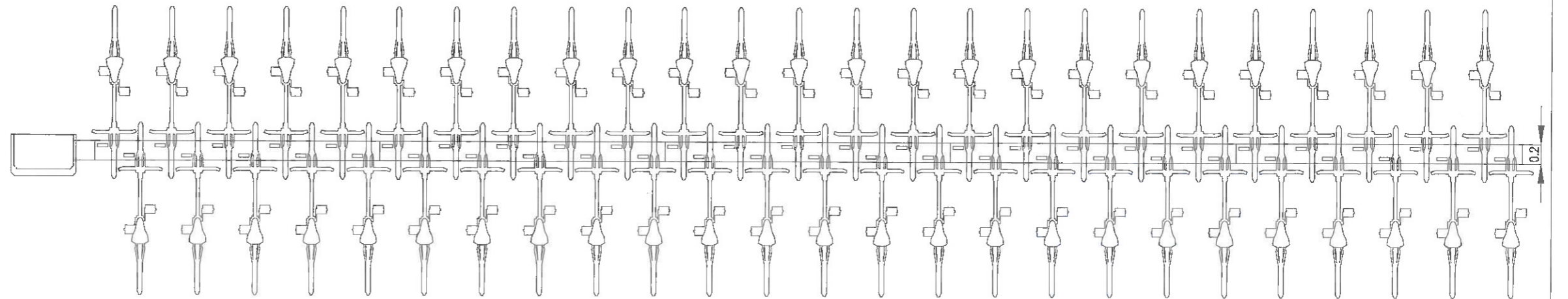
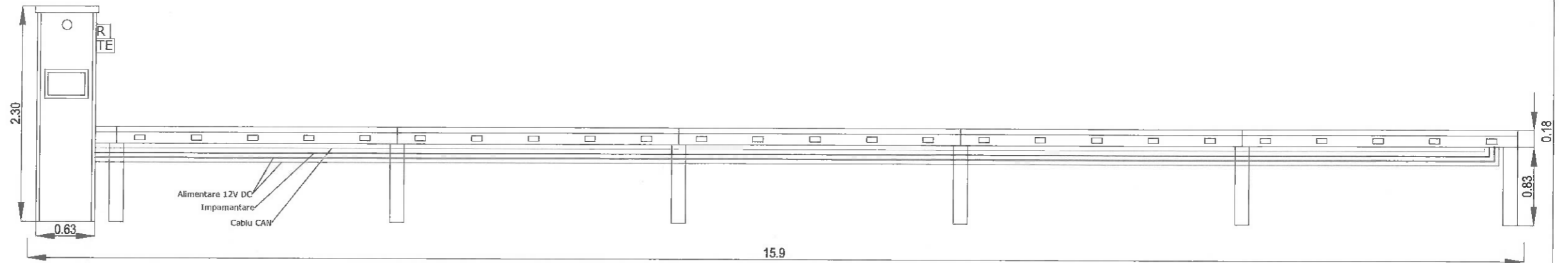

LEGENDA:

- Traseu de impamantare
- Traseu de alimentare 12V DC
- Traseu de date CAN
- Traseu de alimentare de la retea
- Cutie metalica: router; tablou electric de distributie
- BMP Bloc de masura si control

Index	Data	Observatii	Rev. 5
A			
		Beneficiar:	MUNICIPIUL BRASOV Bulevardul Eroilor 8, Brasov 500007
		Nr. proiect	73 / 2020
Sef Proiect		Ing. A. Buta	Faza P.T.
Proiectat		Ing. A. Buta	Titlu planşa: Detaliu amenajare Bike sharing
Desenat		Ing. S. Patroi	
Verificat			
Scara		1:25, 1:50	Nr. planşa
Data		07/2023	D-02