

Sectiunea 9 - Km 0+058.875
Ax-Traseul 1

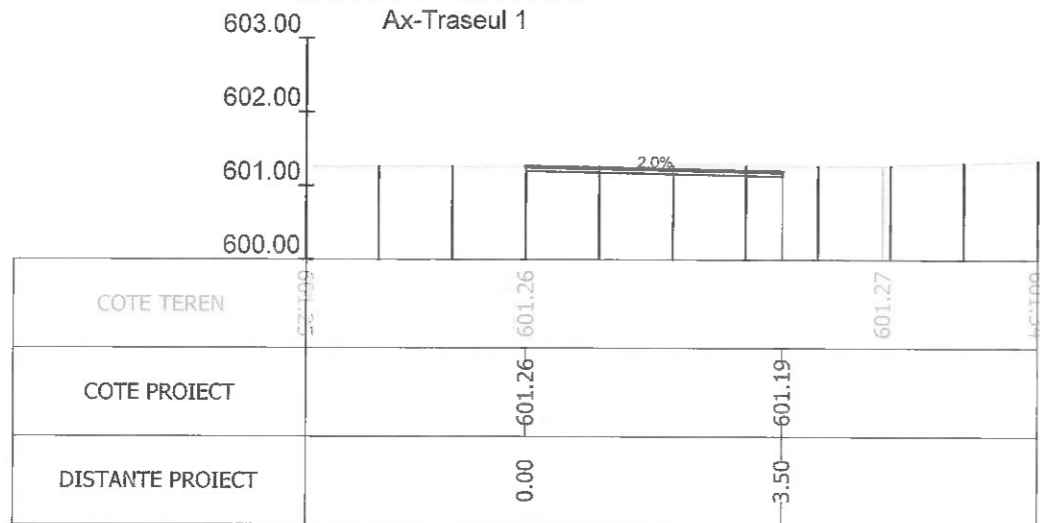

Sectiunea 10 - Km 0+066.661
Ax-Traseul 1

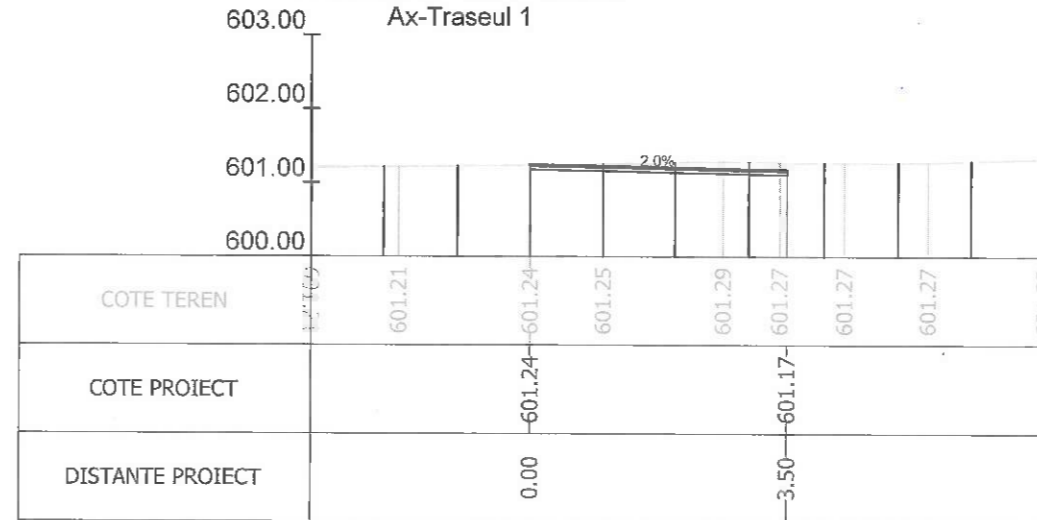

Sectiunea 11 - Km 0+069.738
Ax-Traseul 1

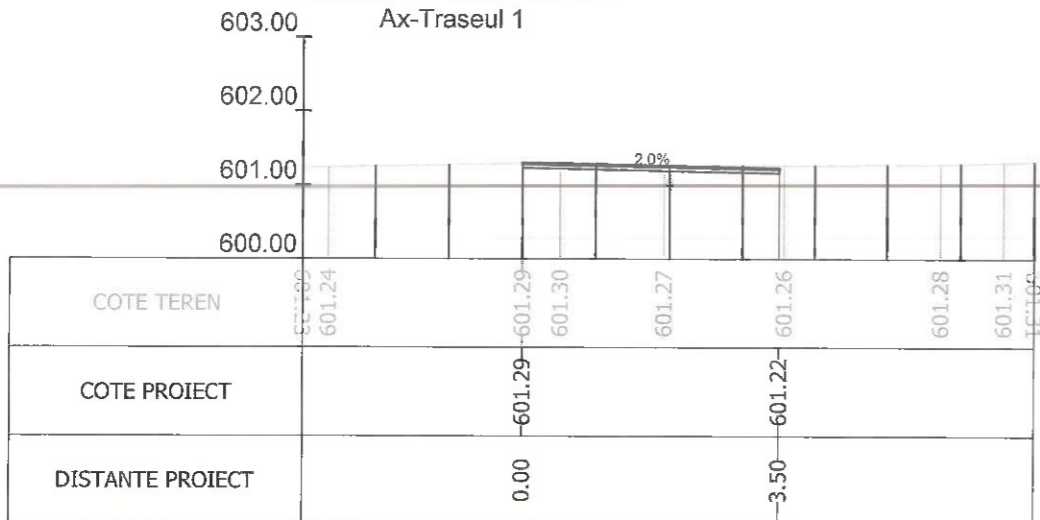

Sectiunea 12 - Km 0+072.816
Ax-Traseul 1

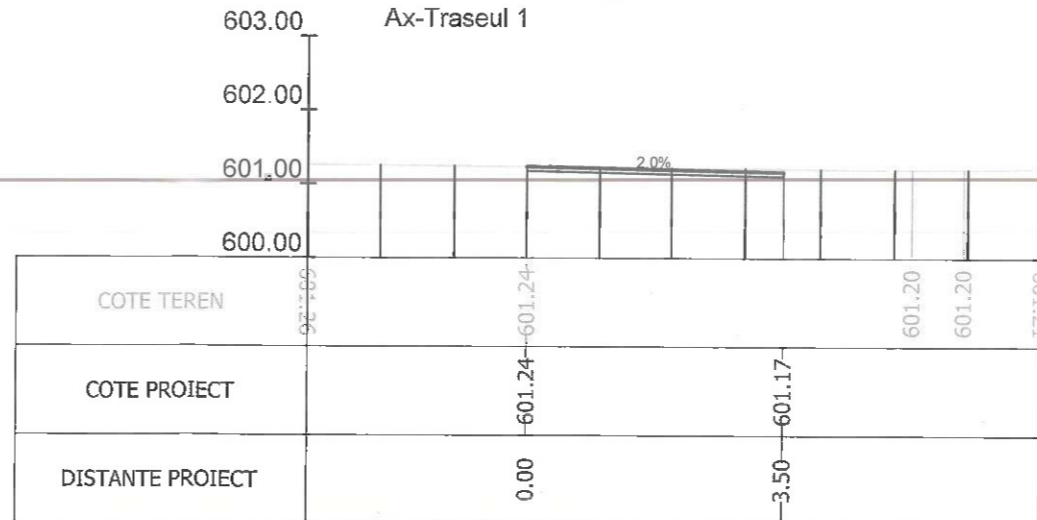

Sectiunea 13 - Km 0+075
Ax-Traseul 1

Sectiunea 14 - Km 0+100
Ax-Traseul 1



Index	Data	Observatii	Rev. 5
A			
		Beneficiar:	MUNICIPIUL BRASOV Bulevardul Eroilor 8, Brasov 500007
Sef Proiect: Ing. A. Buta Proiectat: Ing. A. Buta Desenat: Ing. S. Patroi Verificat:		Nr. proiect:	73 / 2020
Scara: 1/100		Titlu proiect:	AMENAJARE BENZI DEDICATE TRANSPORTULUI PUBLIC IN MUNICIPIUL BRASOV SI TROTUARE ADIACENTE
Data: 07/2023		Titlu plansa:	PROFILE TRANSVERSALE CURENTE
		Nr. plansa:	PT-01

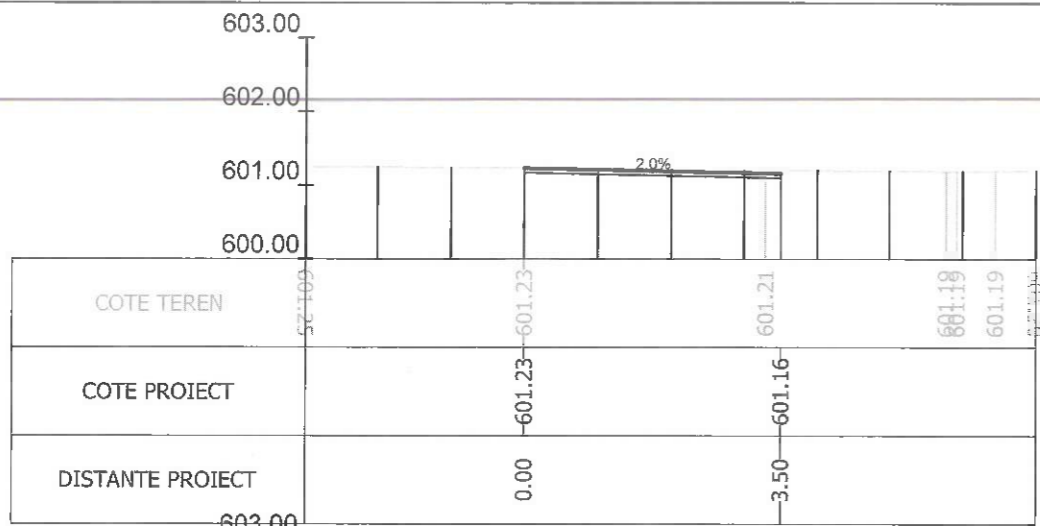

Sectiunea 15 - Km 0+103.169
Ax-Traseul 1

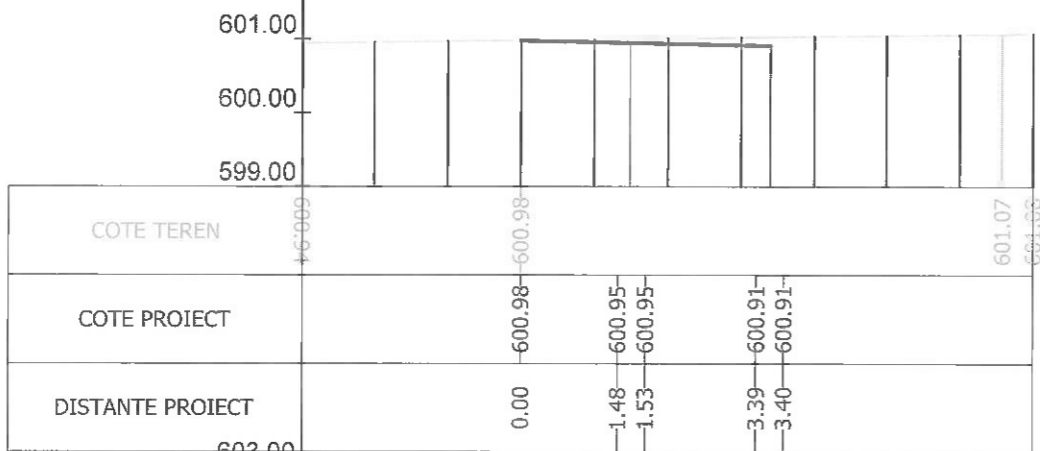

Sectiunea 17 - Km 0+125
Ax-Traseul 1

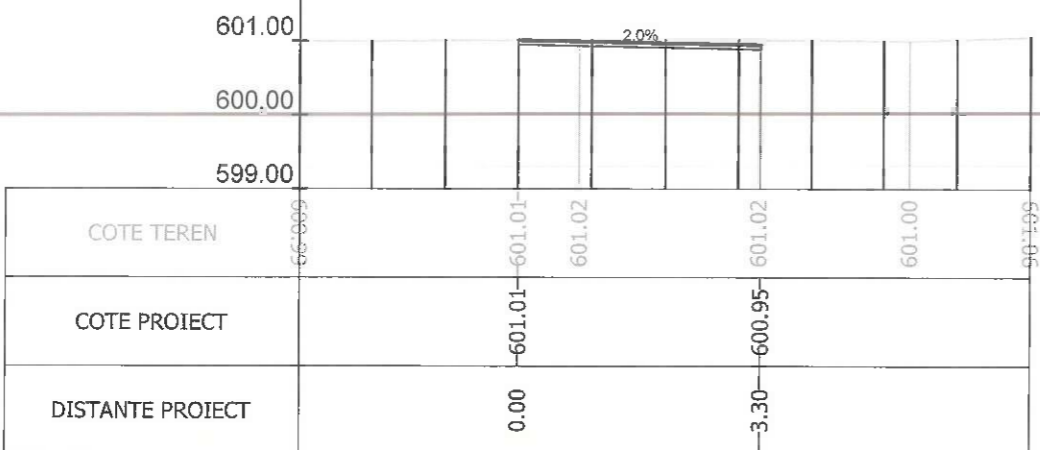

Sectiunea 19 - Km 0+138.615
Ax-Traseul 1

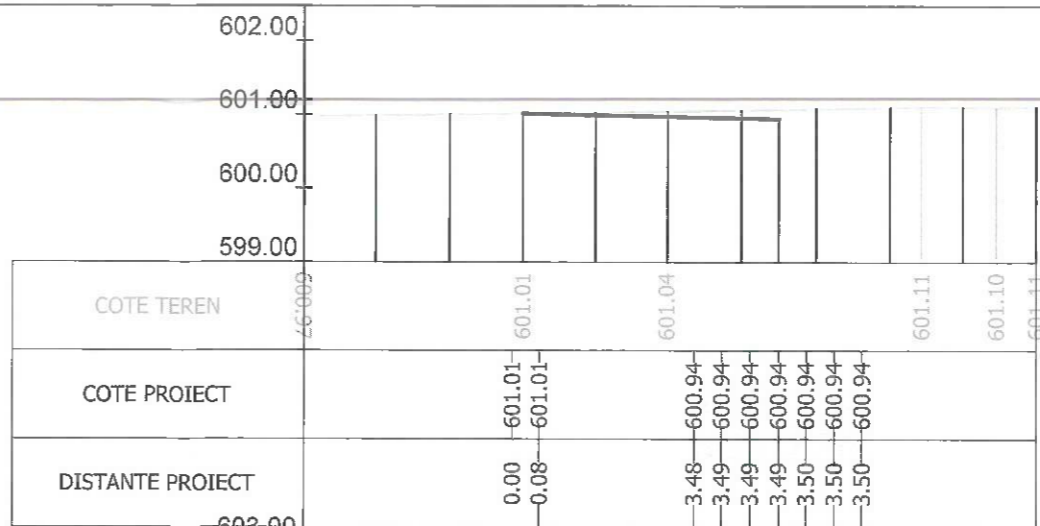

Sectiunea 16 - Km 0+122.288
Ax-Traseul 1

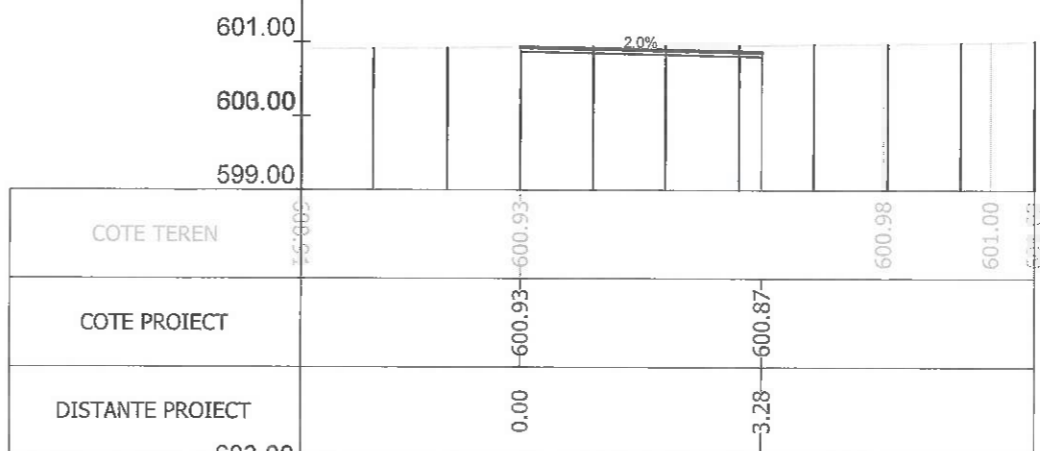

Sectiunea 18 - Km 0+128.325
Ax-Traseul 1

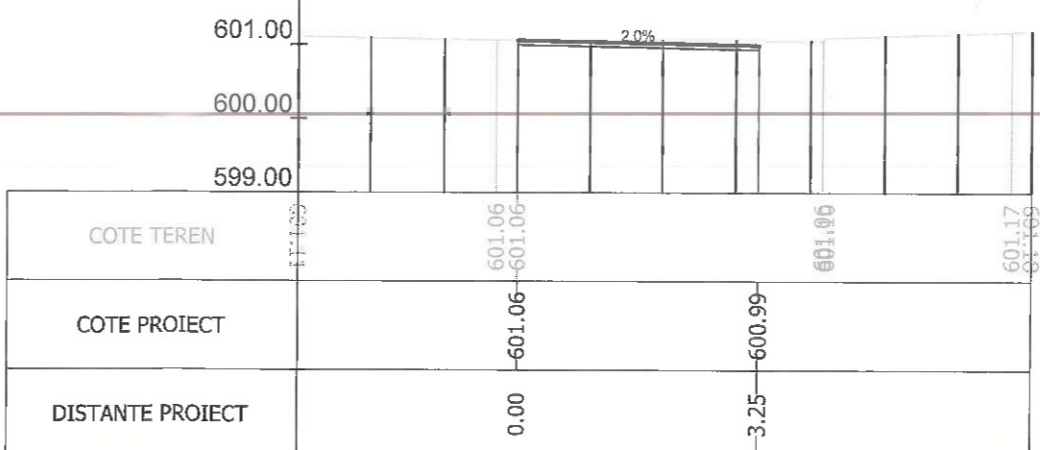

Sectiunea 20 - Km 0+148.906
Ax-Traseul 1



Index	A		Rev. 5
			Beneficiar: MUNICIPIUL BRASOV Bulevardul Eroilor 8, Brasov 500007
Sef Proiect: Ing. A. Buta Proiectat: Ing. A. Buta Desenat: Ing. S. Patroi Verificat:			Nr. proiect: 73 / 2020 Faza: P.T.
Scara: 1/100 Data: 07/2023			Nr. plansa: PT-02
Titlu proiect: AMENAJARE BENZI DEDICATE TRANSPORTULUI PUBLIC IN MUNICIPIUL BRASOV SI TROTUARE ADIACENTE Titlu plansa: PROFILE TRANSVERSALE CURENTE			

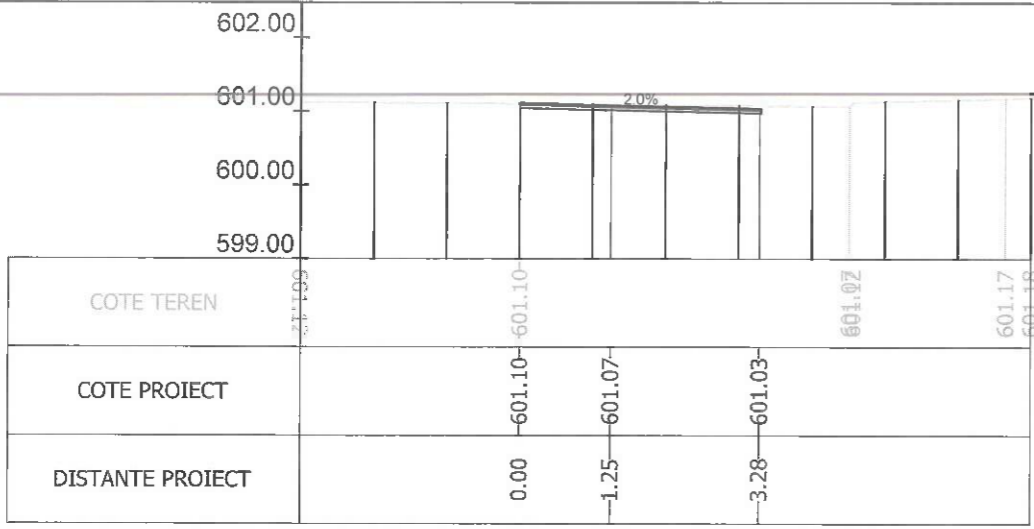

Sectiunea 21 - Km 0+150
Ax-Traseul 1

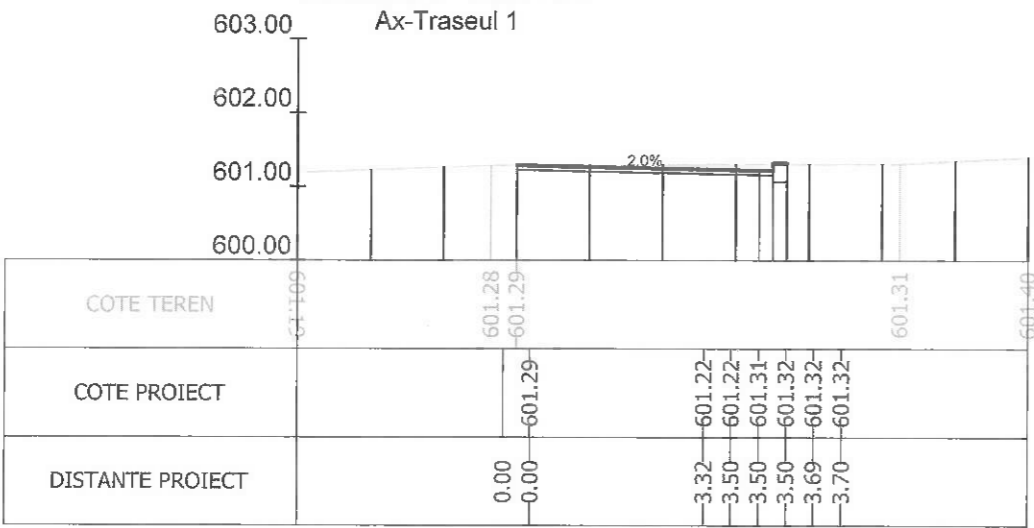

Sectiunea 30 - Km 0+275
Ax-Traseul 1

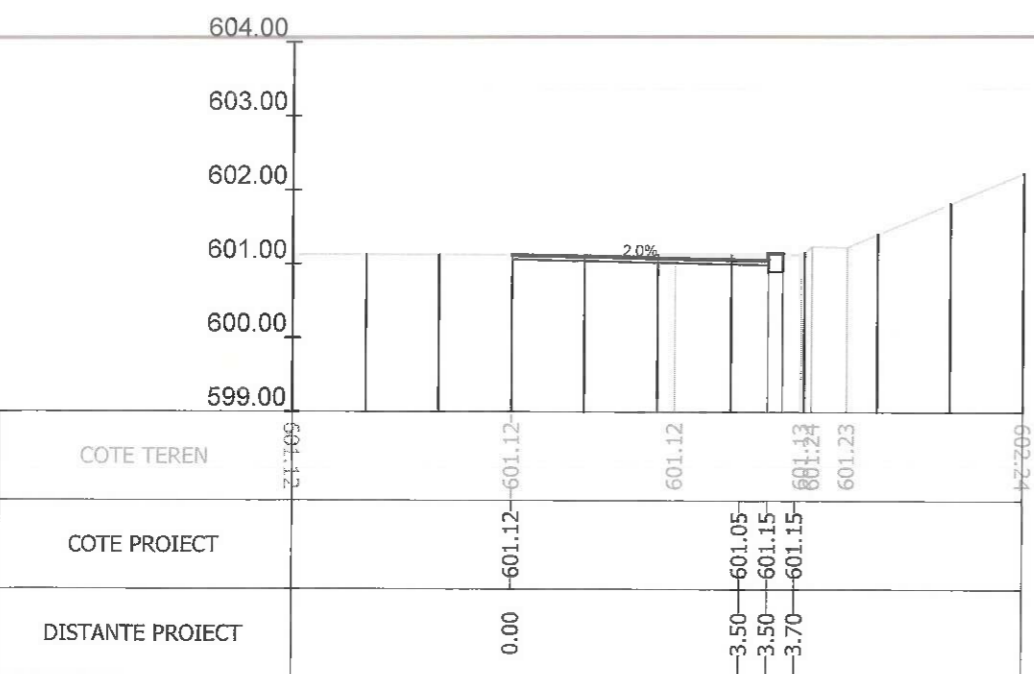

Sectiunea 32 - Km 0+300
Ax-Traseul 1

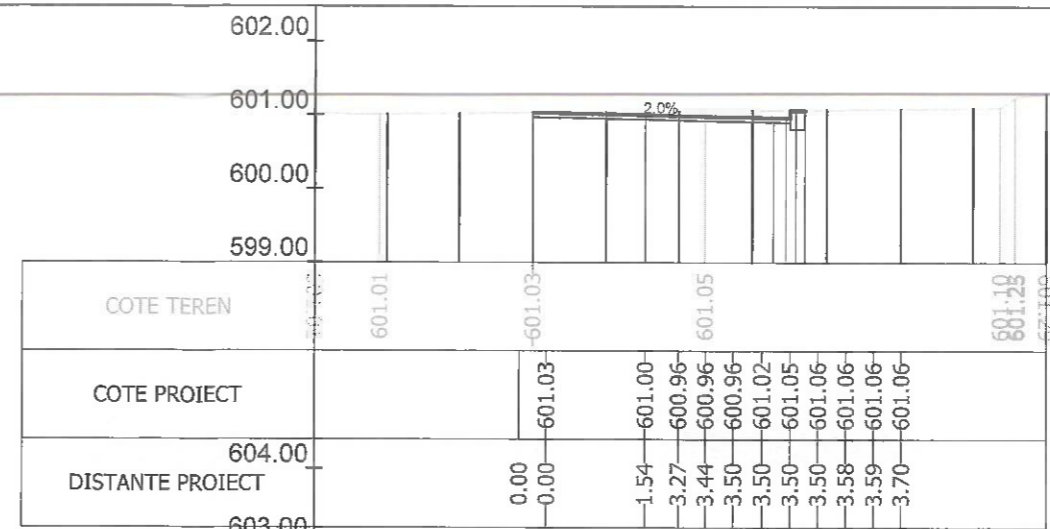

Sectiunea 29 - Km 0+267
Ax-Traseul 1

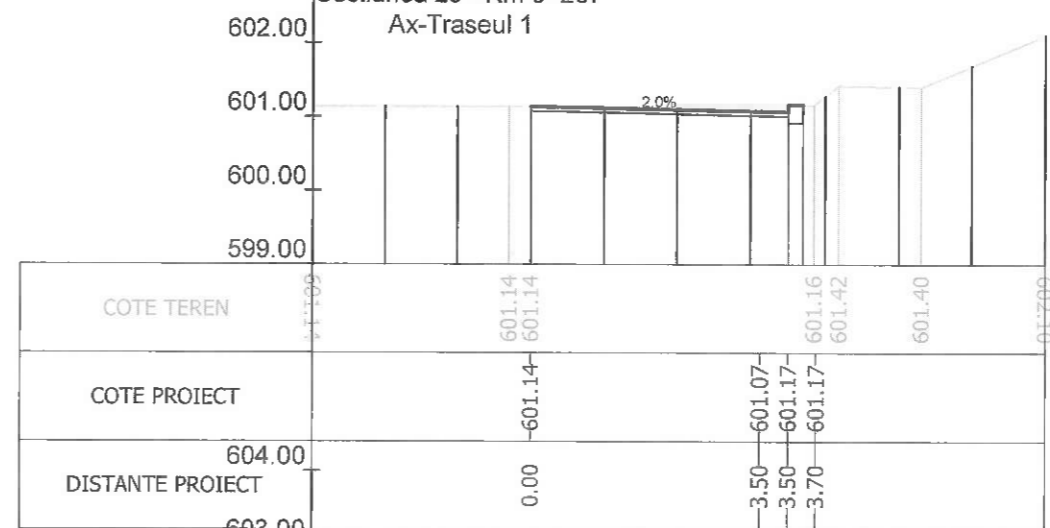

Sectiunea 31 - Km 0+296.053
Ax-Traseul 1

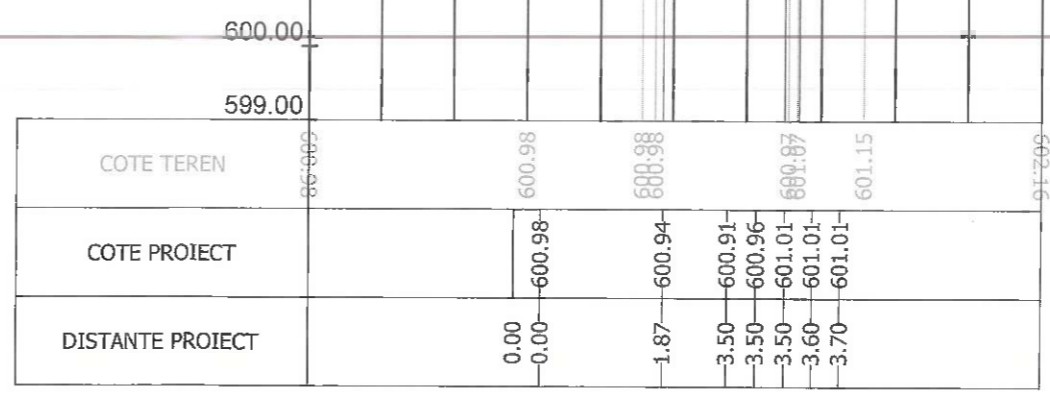

Sectiunea 33 - Km 0+325
Ax-Traseul 1

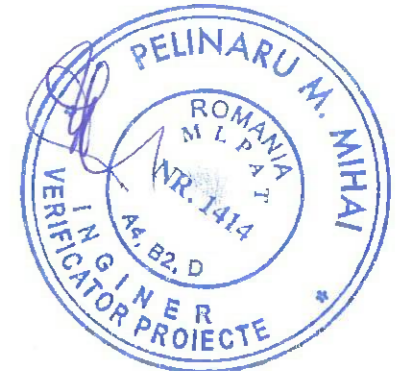

Index	A		Rev. 5
			Beneficiar: MUNICIPIUL BRASOV Bulevardul Eroilor 8, Brasov 500007
Sef Proiect	Ing. A. Buta		Nr. proiect: 73 / 2020
Proiectat	Ing. A. Buta		Faza P.T.
Desenat	Ing. S. Patroi		Nr. plansa: PT-03
Verificat			
Scara 1/100			Titlu proiect: AMENAJARE BENZI DEDICATE TRANSPORTULUI PUBLIC IN MUNICIPIUL BRASOV SI TROTUARE ADIACENTE
Data 07/2023			Titlu plansa: PROFILE TRANSVERSALE CURENTE

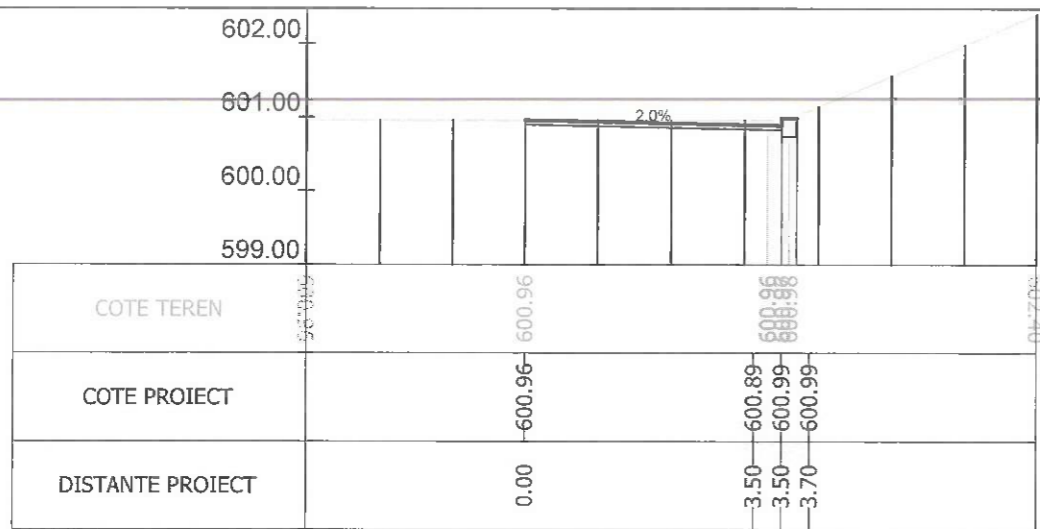

Sectiunea 34 - Km 0+326.302

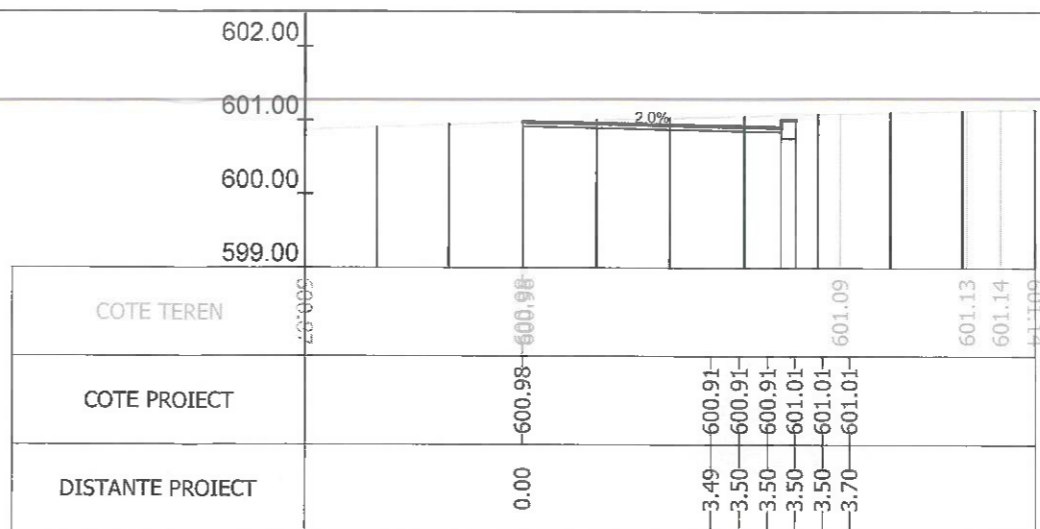
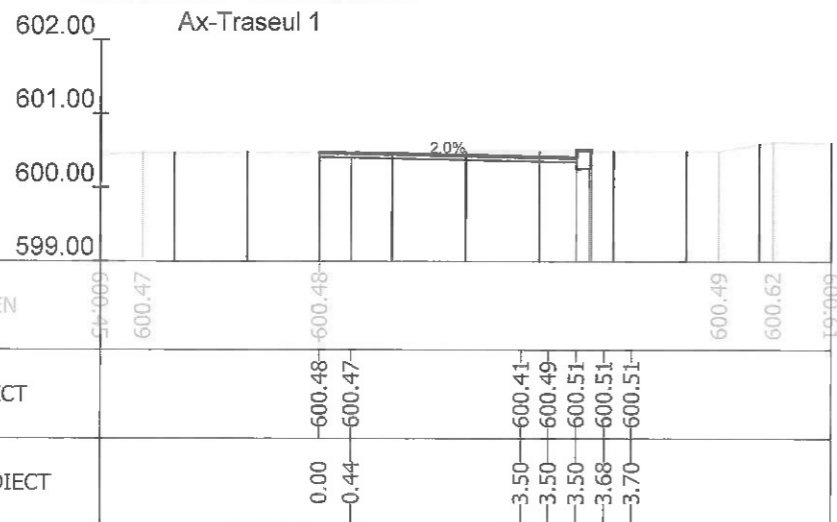

Sectiunea 35 - Km 0+350

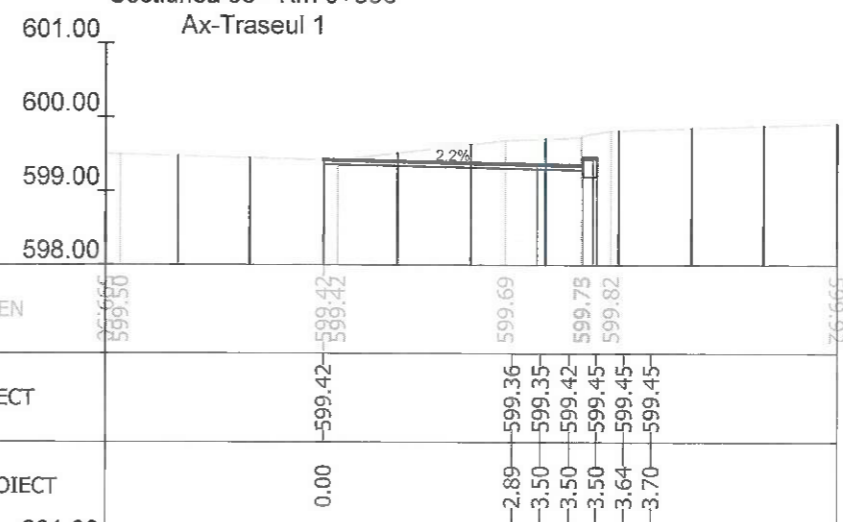

Sectiunea 36 - Km 0+375
Ax-Traseul 1

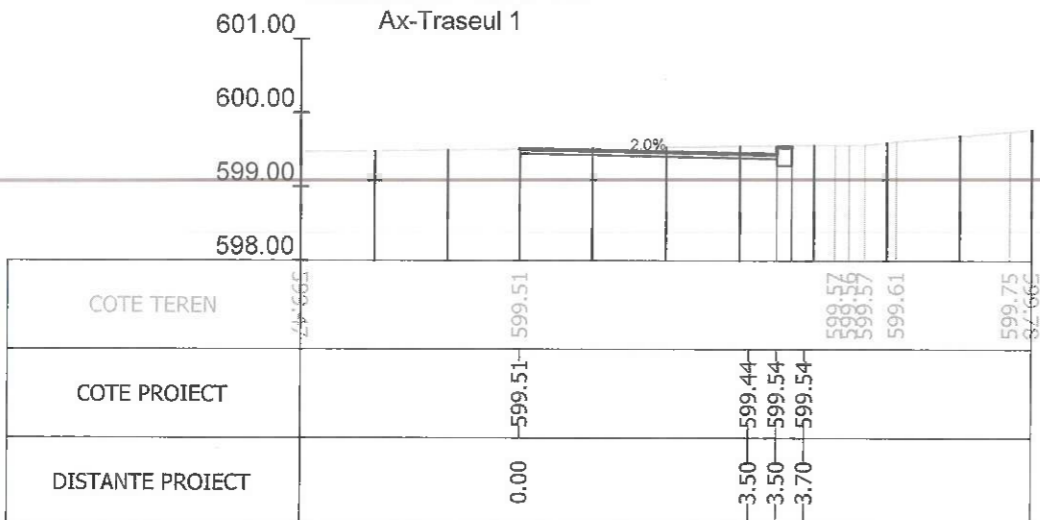

Sectiunea 38 - Km 0+400
Ax-Traseul 1

Sectiunea 37 - Km 0+395.970
Ax-Traseul 1

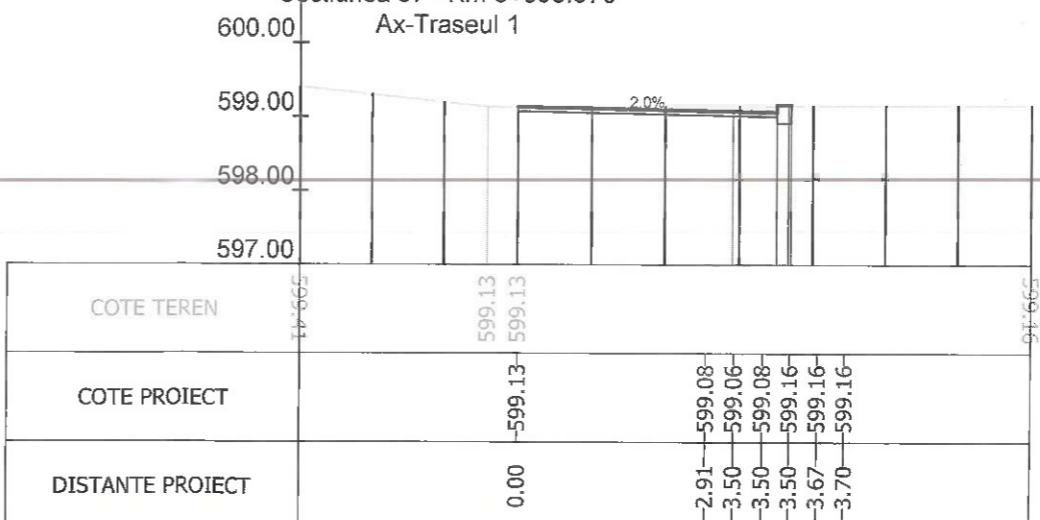

Sectiunea 39 - Km 0+425

Index	Data	Observatii	Rev. 5
A			
		Beneficiar:	MUNICIPIUL BRASOV Bulevardul Eroilor 8, Brasov 500007
Sef Proiect: Ing. A. Buta Proiectat: Ing. A. Buta Desenat: Ing. S. Patroi Verificat:		Titlu proiect:	AMENAJARE BENZI DEDICATE TRANSPORTULUI PUBLIC IN MUNICIPIUL BRASOV SI TROTUARE ADJACENTE
Scara: 1/100 Data: 07/2023		Titlu plansa:	PROFILE TRANSVERSALE CURENTE
		Nr. proiect:	73 / 2020
		Faza P.T.:	
		Nr. plansa:	PT-04

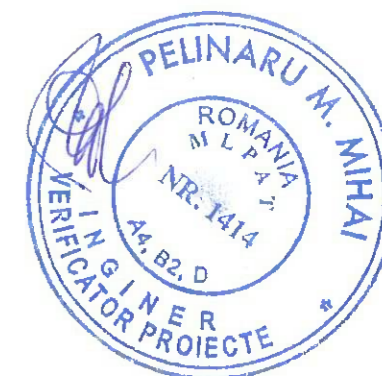

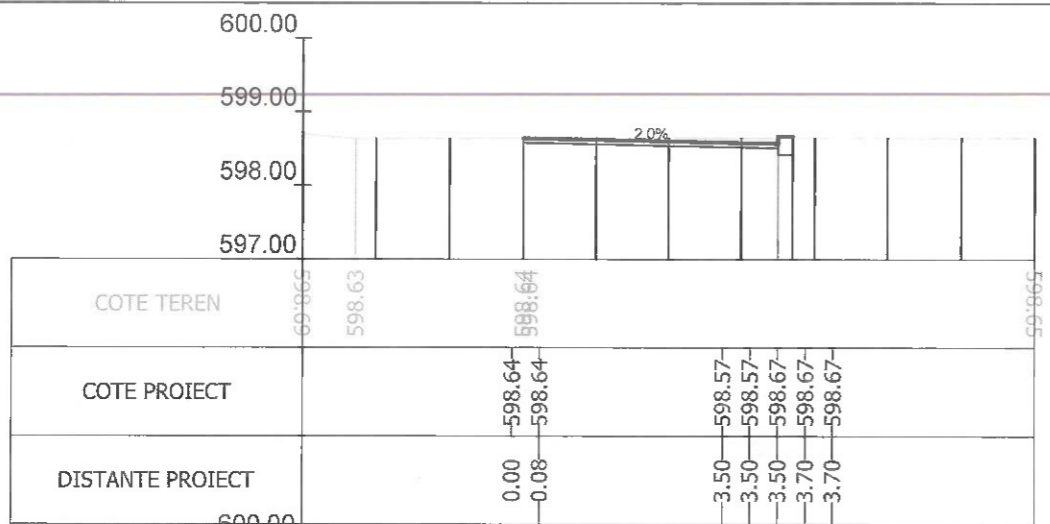

Sectiunea 40 - Km 0+450
Ax-Traseul 1

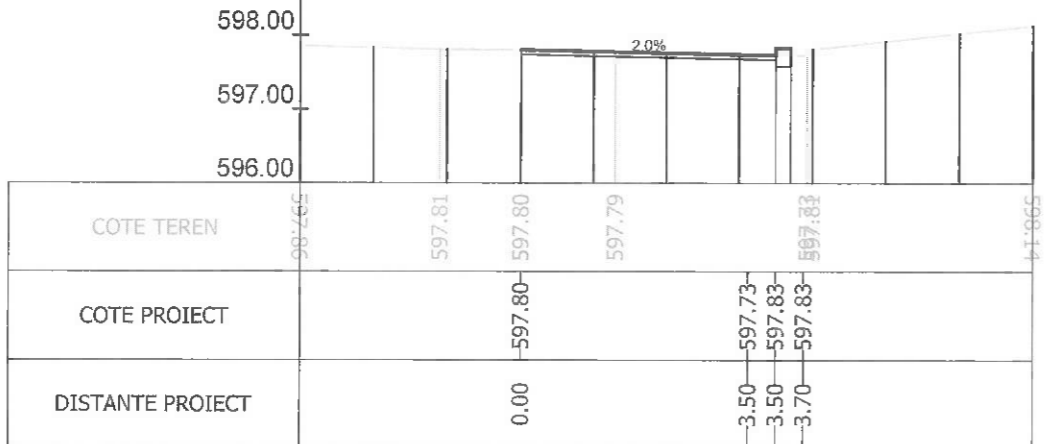

Sectiunea 42 - Km 0+477.766
Ax-Traseul 1

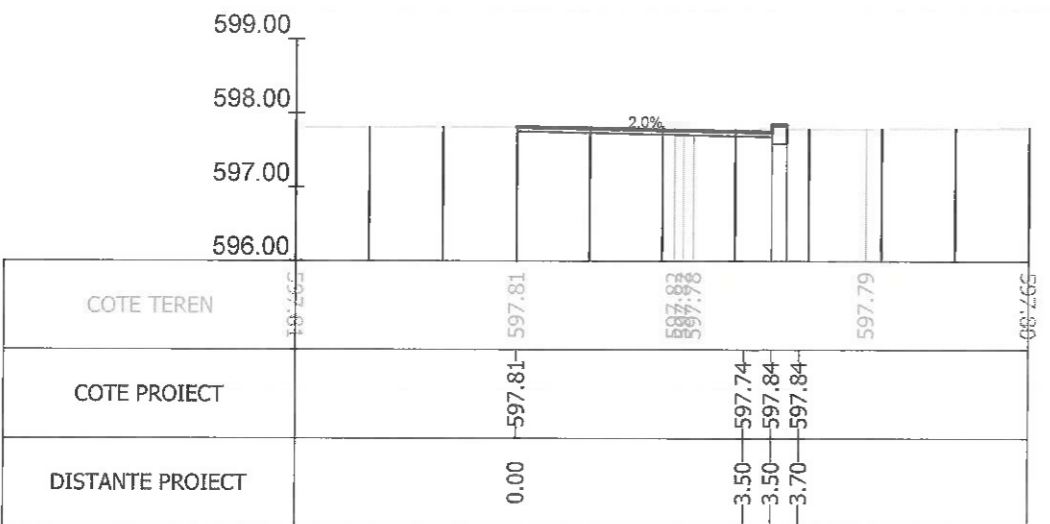

Sectiunea 44 - Km 0+500
Ax-Traseul 1

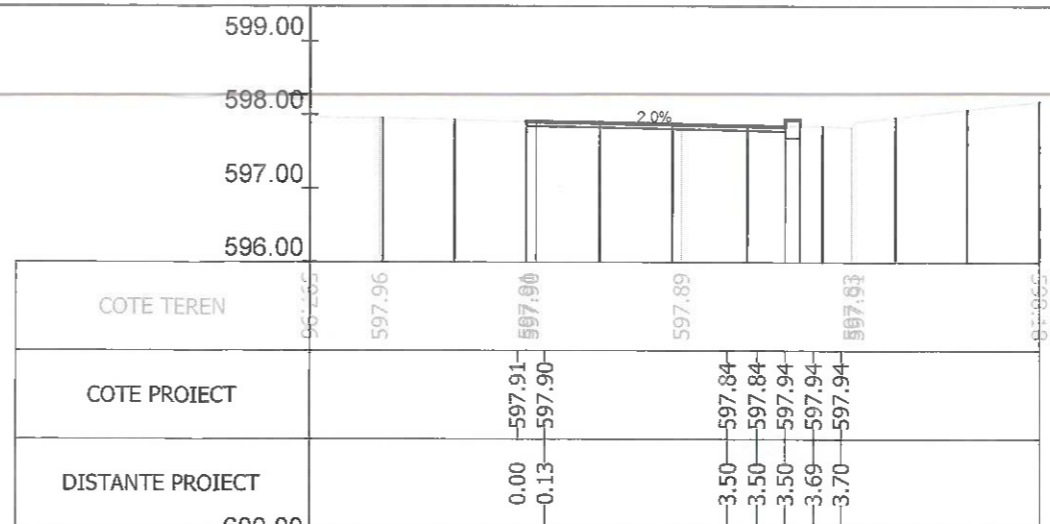

Sectiunea 41 - Km 0+475
Ax-Traseul 1

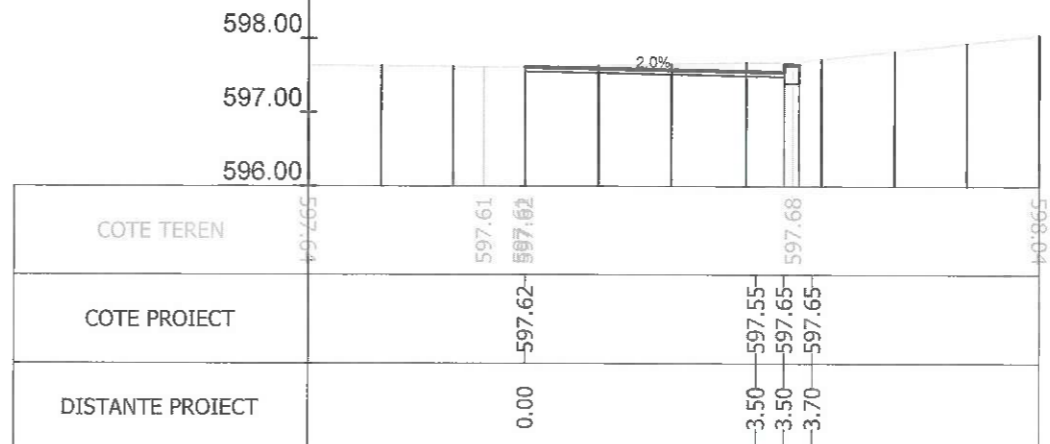

Sectiunea 43 - Km 0+483.601
Ax-Traseul 1

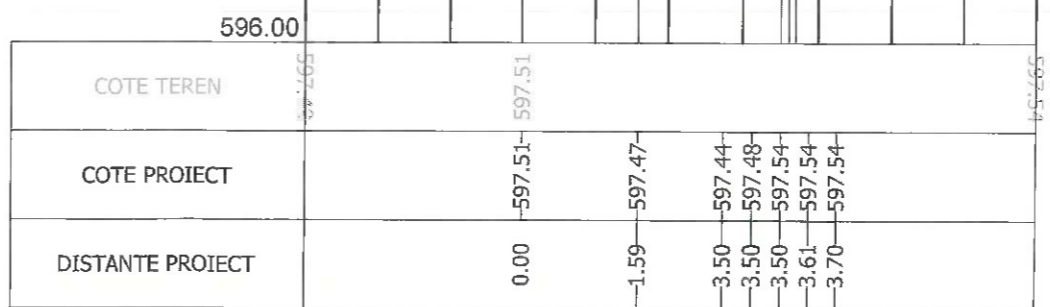

Sectiunea 45 - Km 0+525
Ax-Traseul 1



Index	Data	Rev. 5
A		
		Beneficiar: MUNICIPIUL BRASOV Bulevardul Eroilor 8, Brasov 500007
Sef Proiect: Ing. A. Buta Proiectat: Ing. A. Buta Desenat: Ing. S. Patroi Verificat:		Nr. proiect: 73 / 2020 Faza: P.T.
Scara: 1/100 Data: 07/2023		Nr. plansa: PT-05
Titlu proiect: AMENAJARE BENZI DEDICATE TRANSPORTULUI PUBLIC IN MUNICIPIUL BRASOV SI TROTUARE ADIACENTE Titlu plansa: PROFILE TRANSVERSALE CURENTE		

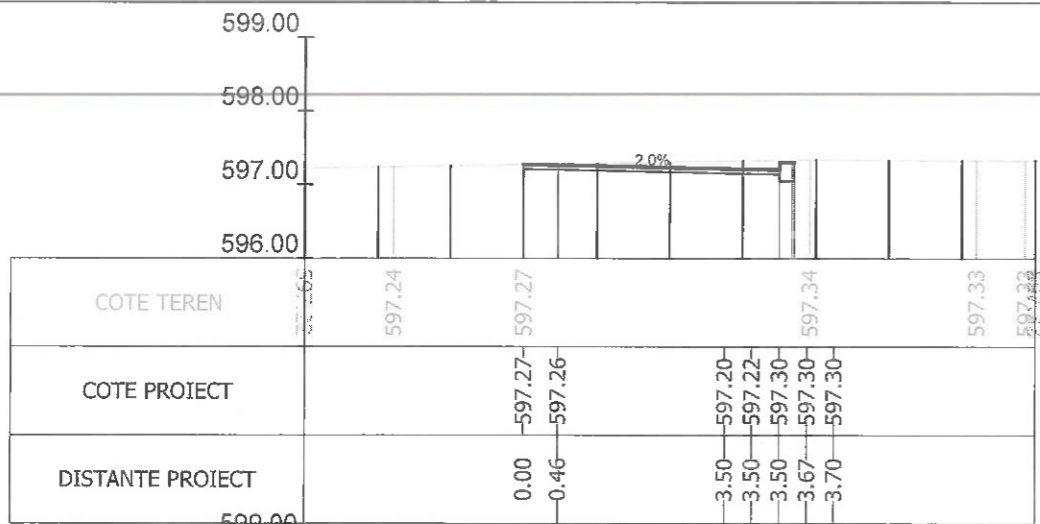

Sectiunea 46 - Km 0+550
Ax-Traseul 1

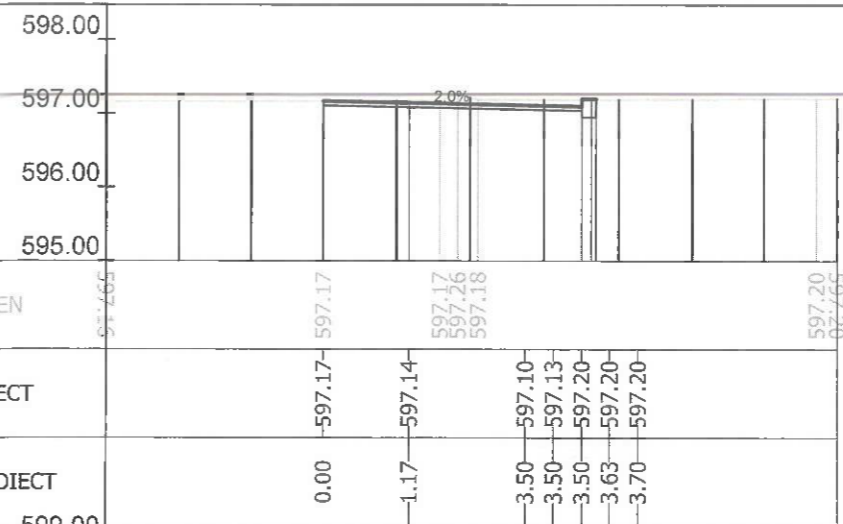
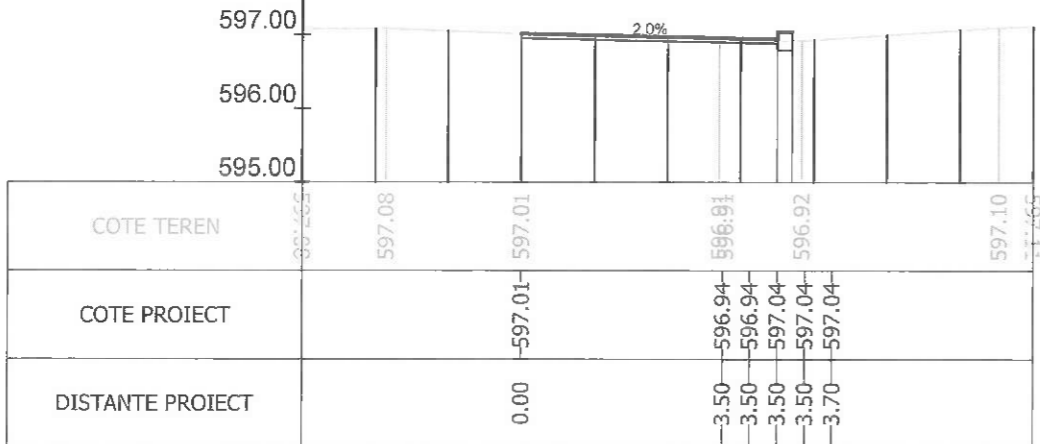

Sectiunea 47 - Km 0+575
Ax-Traseul 1

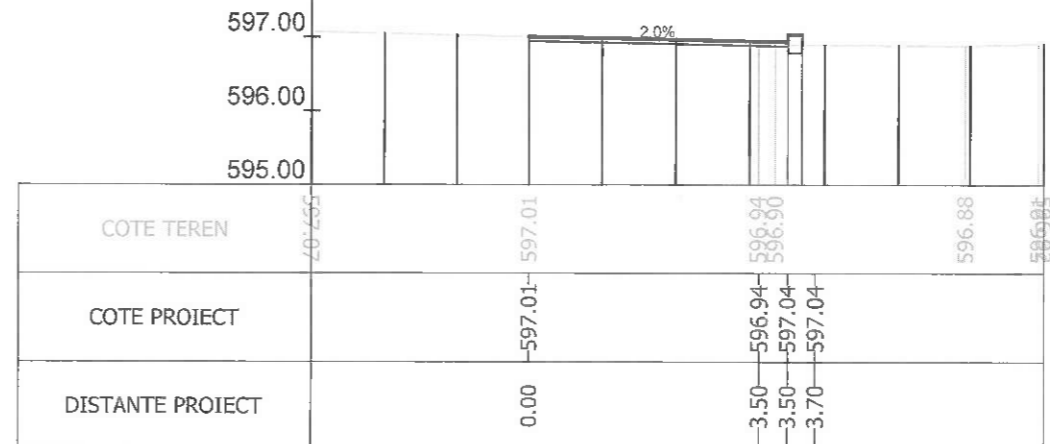

Sectiunea 49 - Km 0+600
Ax-Traseul 1

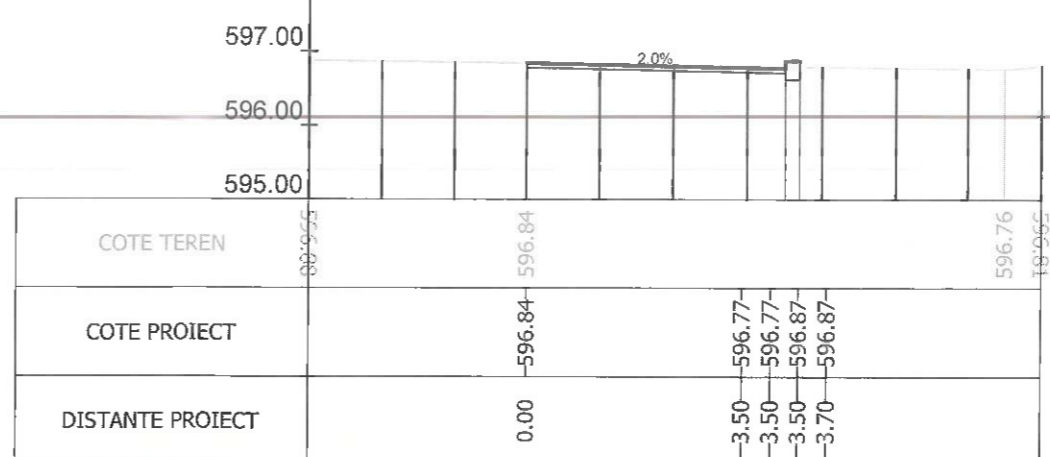

Sectiunea 50 - Km 0+625
Ax-Traseul 1

Sectiunea 51 - Km 0+630.178

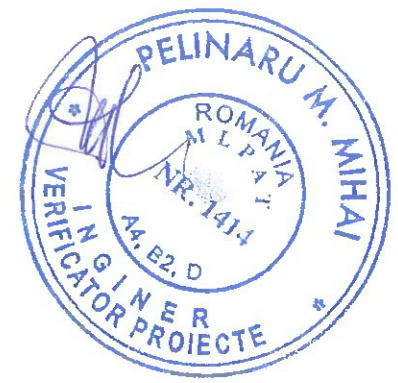

Index	Ax-Traseul		Rev. 5
A			
			Beneficiar: MUNICIPIUL BRASOV Bulevardul Eroilor 8, Brasov 500007
Sef Proiect: Ing. A. Buta Proiectat: Ing. A. Buta Desenat: Ing. S. Patroi Verificat:			Nr. proiect: 73 / 2020
Scara: 1/100 Data: 07/2023			Faza: P.T.
Titlu proiect: AMENAJARE BENZI DEDICATE TRANSPORTULUI PUBLIC IN MUNICIPIUL BRASOV SI TROTUARE ADIACENTE Titlu plansa: PROFILE TRANSVERSALE CURENTE			Nr. plansa: PT-06

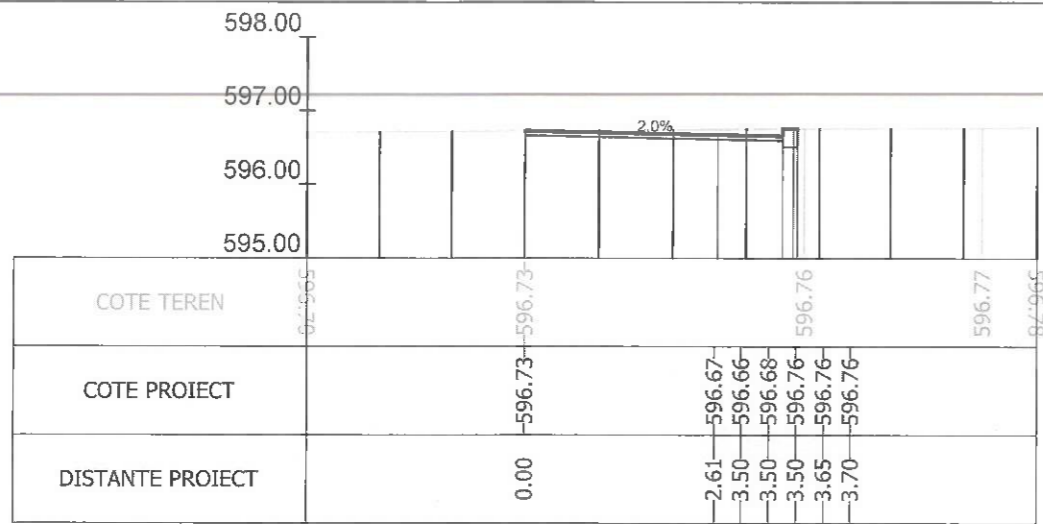

Sectiunea 52 - Km 0+650
Ax-Traseul 1

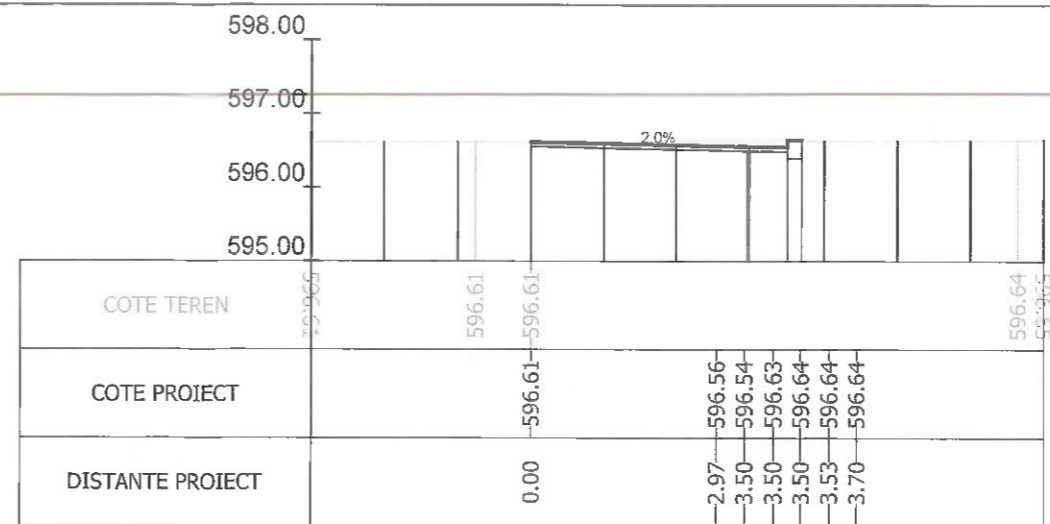
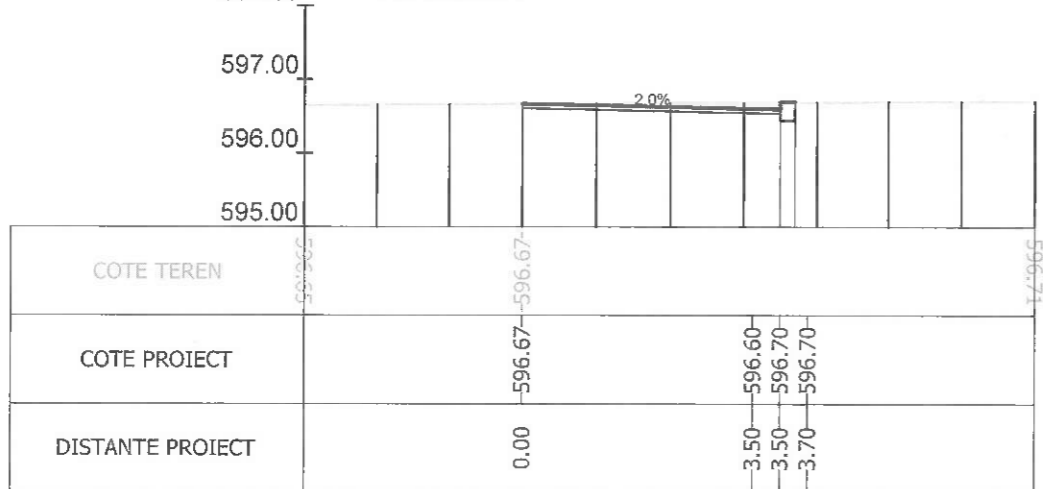

Sectiunea 53 - Km 0+675
Ax-Traseul 1

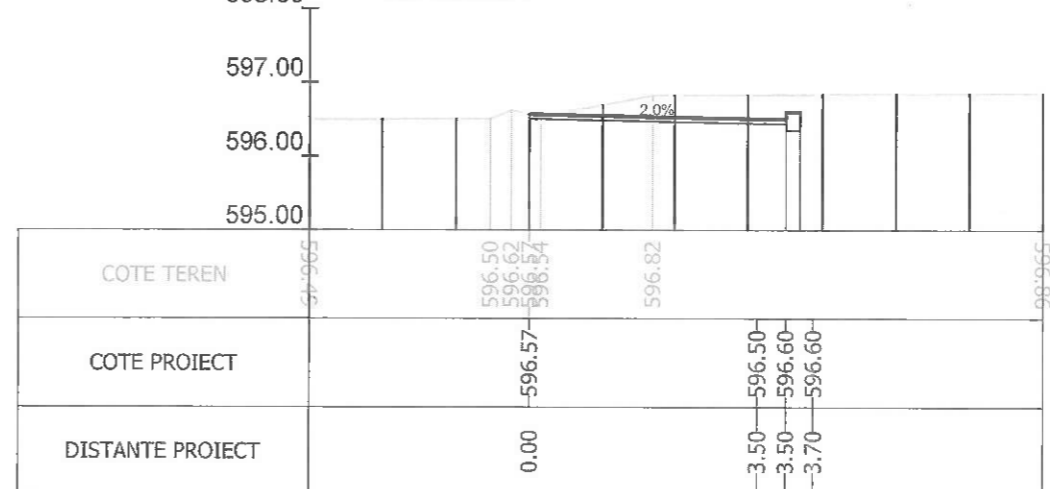

Sectiunea 54 - Km 0+700
Ax-Traseul 1

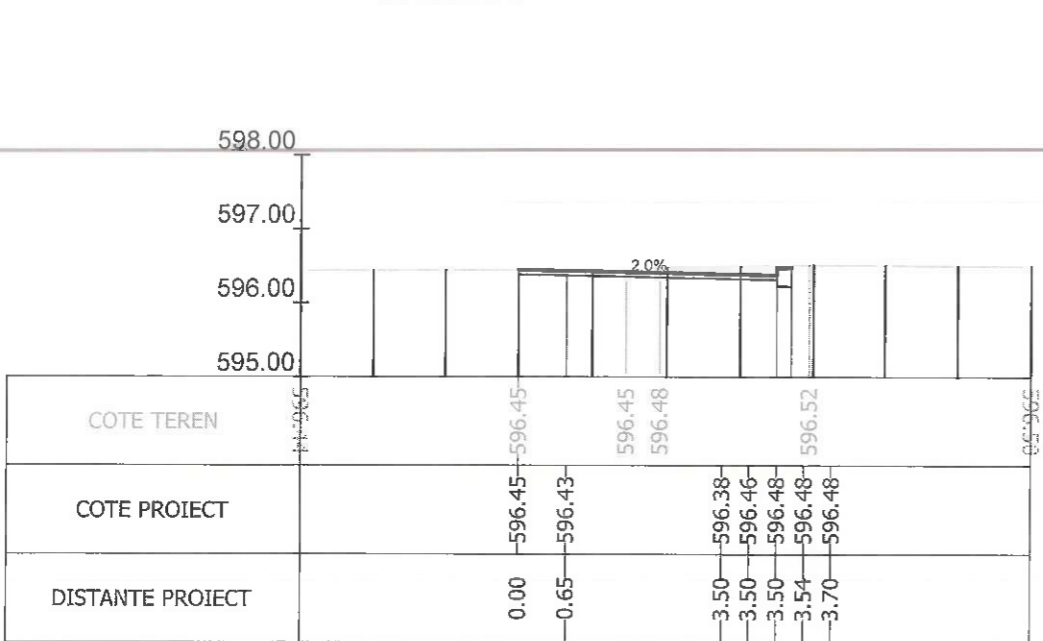

Sectiunea 56 - Km 0+725
Ax-Traseul 1

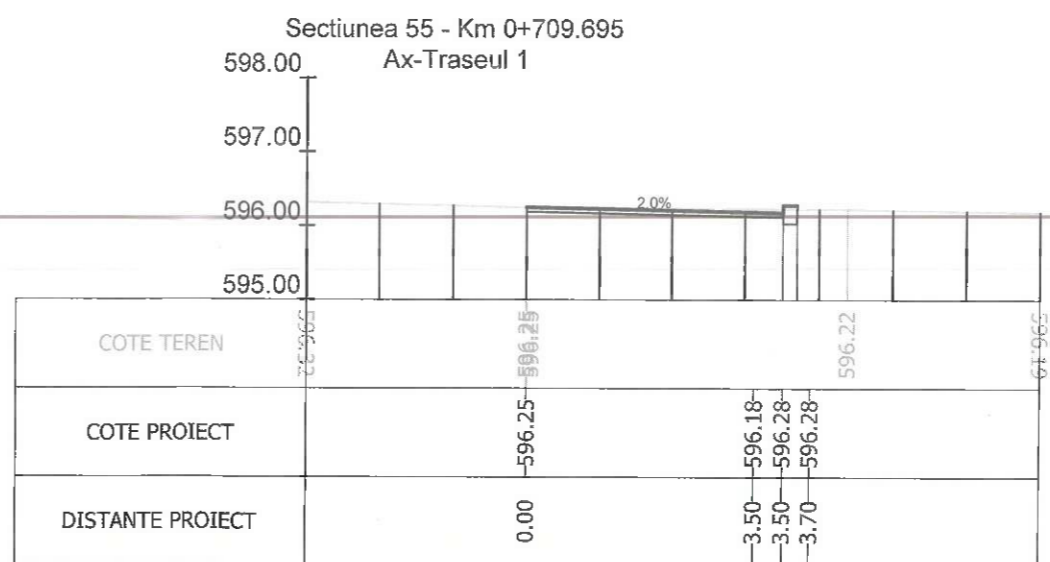

Sectiunea 57 - Km 0+743.692

Index	Del. Ax-Traseul	Observatii	Rev. 5
A			
		Beneficiar:	MUNICIPIUL BRASOV Bulevardul Eroilor 8, Brasov 500007
Sef Proiect	Ing. A. Buta	Titlu proiect:	AMENAJARE BENZI DEDICATE TRANSPORTULUI PUBLIC IN MUNICIPIUL BRASOV SI TROTUARE ADIACENTE
Proiectat	Ing. A. Buta	Titlu plansa:	PROFILE TRANSVERSALE CURENTE
Desenat	Ing. S. Patroi	Scara	1/100
Verificat		Data	07/2023
		Nr. proiect	73 / 2020
		Faza	P.T.
		Nr. plansa	PT-07



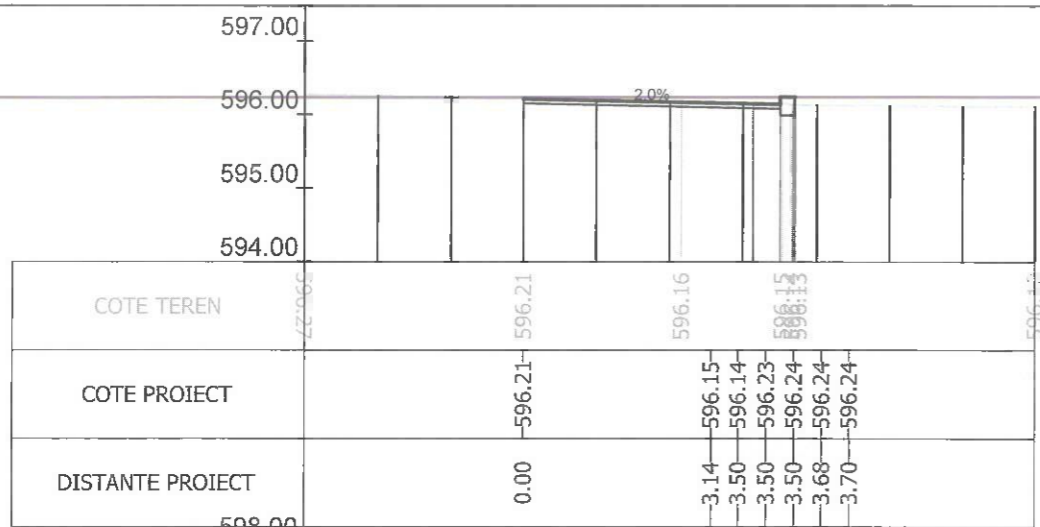

Sectiunea 58 - Km 0+750
Ax-Traseul 1

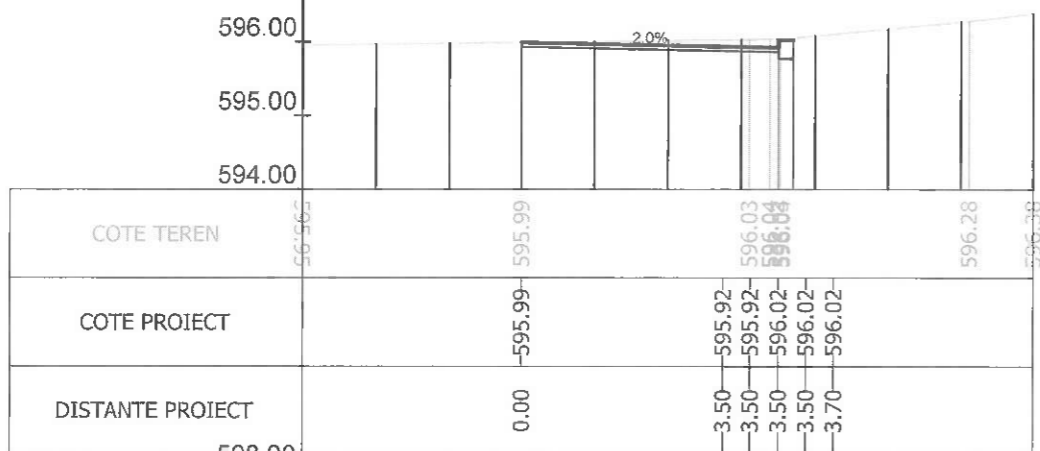

Sectiunea 60 - Km 0+772.950
Ax-Traseul 1

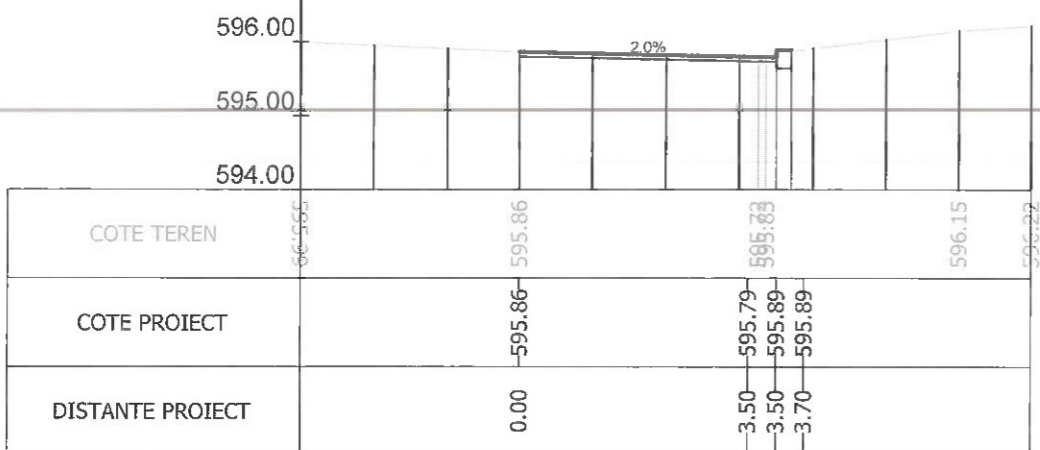

Sectiunea 62 - Km 0+800
Ax-Traseul 1

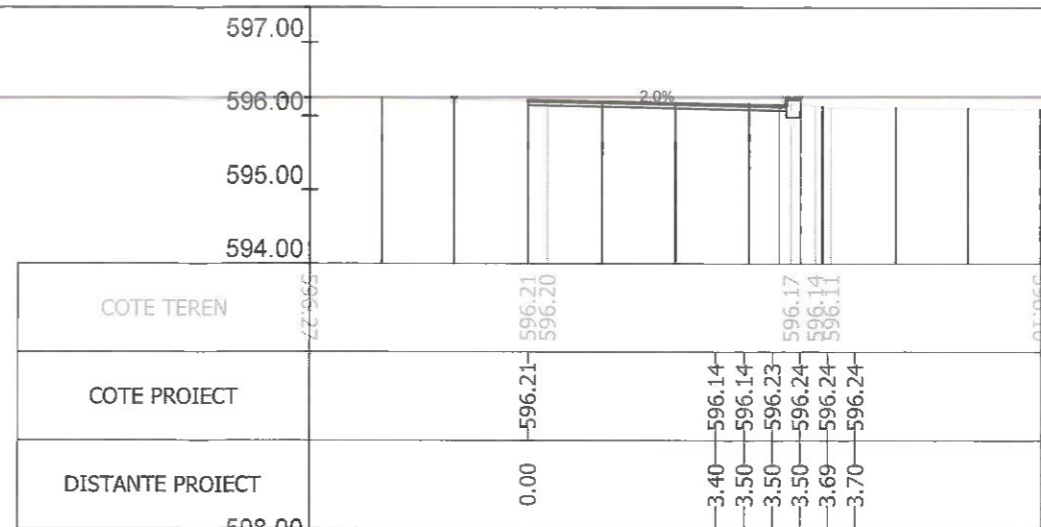

Sectiunea 59 - Km 0+750.293
Ax-Traseul 1

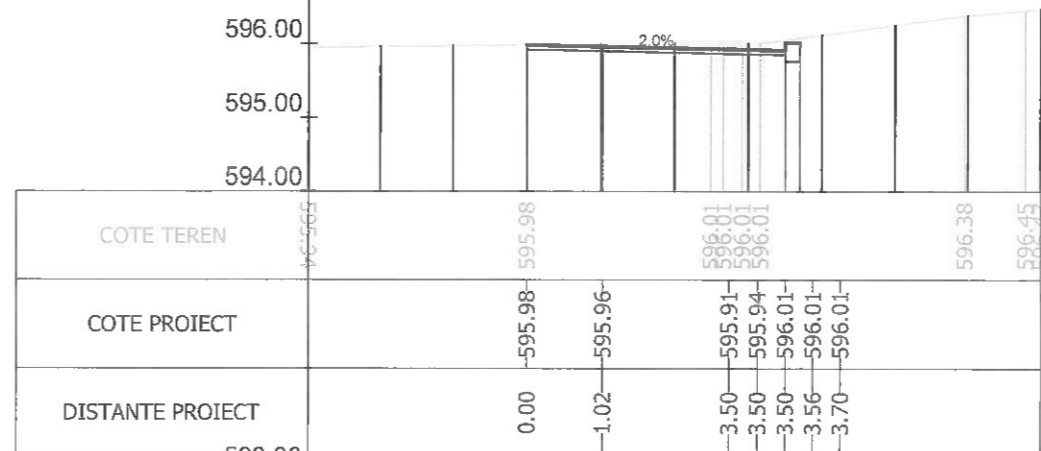

Sectiunea 61 - Km 0+775
Ax-Traseul 1

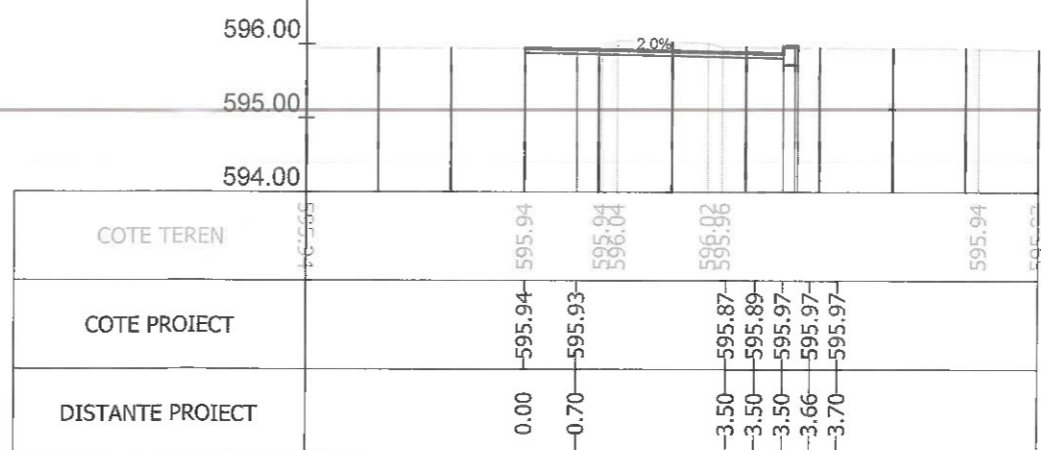

Sectiunea 63 - Km 0+825
Ax-Traseul 1



Index	Data		Rev. 5
A			
			Beneficiar: MUNICIPIUL BRASOV Bulevardul Eroilor 8, Brasov 500007
Sef Proiect: Ing. A. Buta Proiectat: Ing. A. Buta Desenat: Ing. S. Patroi Verificat:			Nr. proiect: 73 / 2020 Faza P.T.
Scara: 1/100 Data: 07/2023			Nr. plansa: PT-08
Titlu proiect: AMENAJARE BENZI DEDICATE TRANSPORTULUI PUBLIC IN MUNICIPIUL BRASOV SI TROTUARE ADIACENTE Titlu plansa: PROFILE TRANSVERSALE CURENTE			

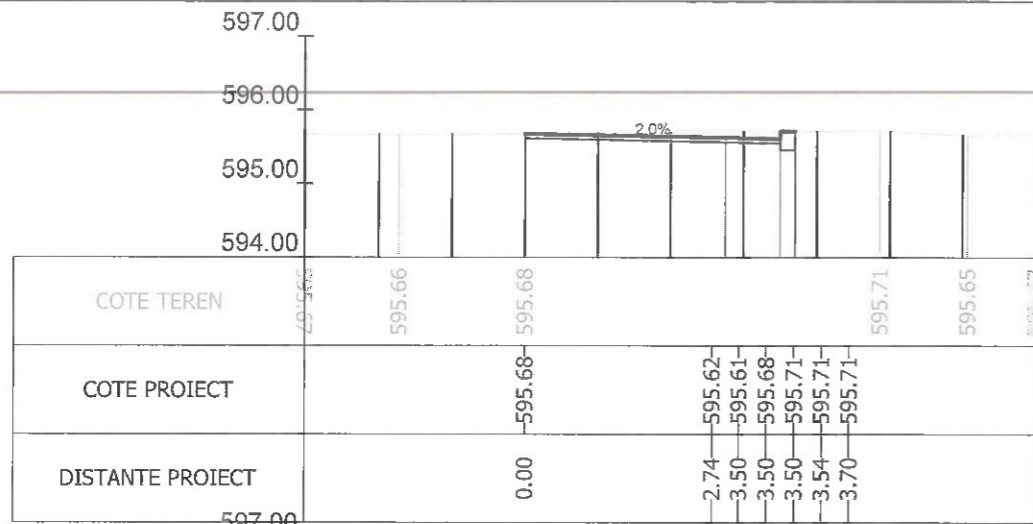

Sectiunea 64 - Km 0+850
Ax-Traseul 1

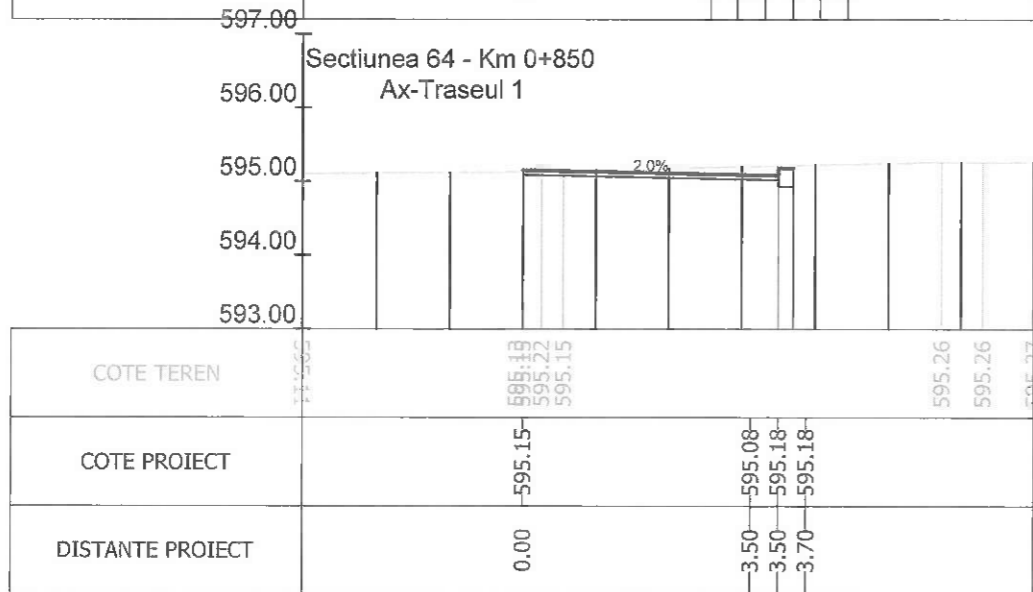

Sectiunea 66 - Km 0+892.837
Ax-Traseul 1

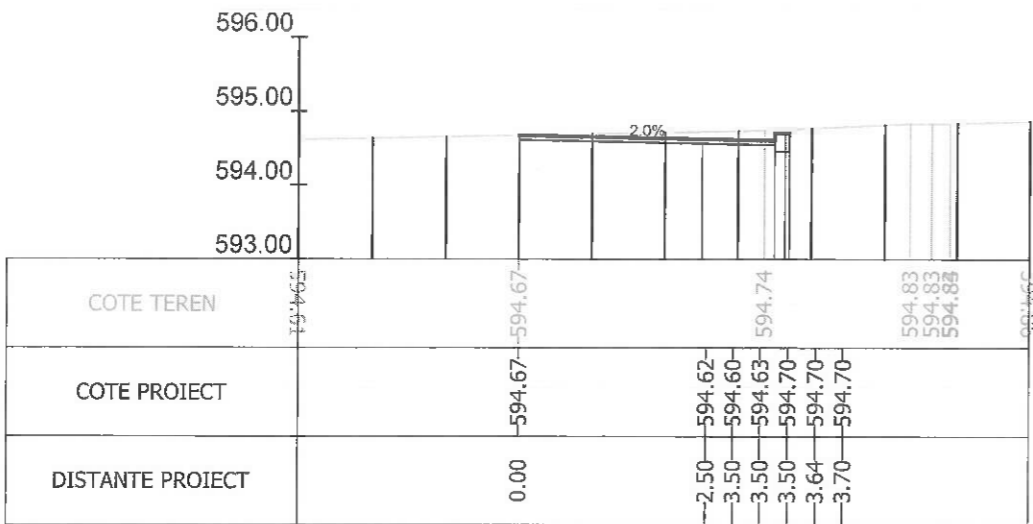

Sectiunea 68 - Km 0+925
Ax-Traseul 1

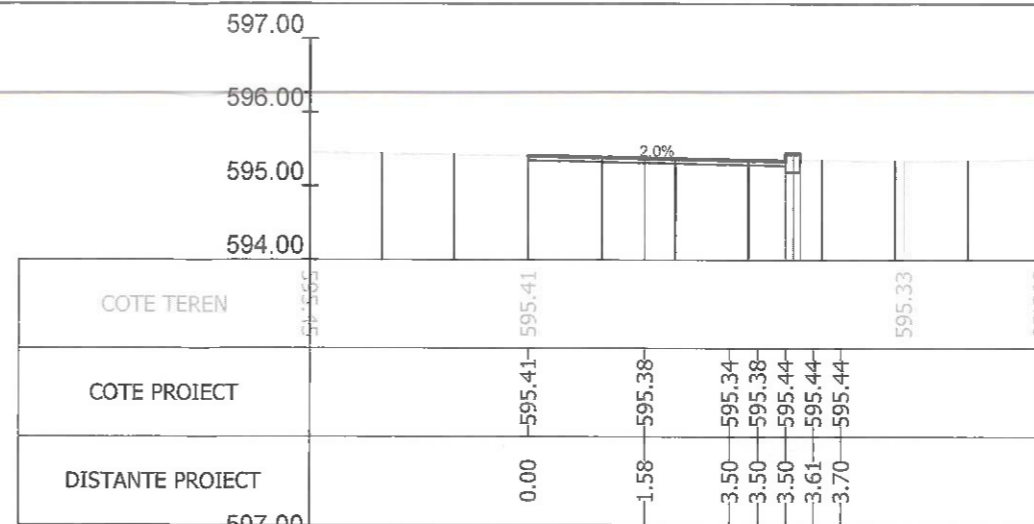

Sectiunea 65 - Km 0+875
Ax-Traseul 1

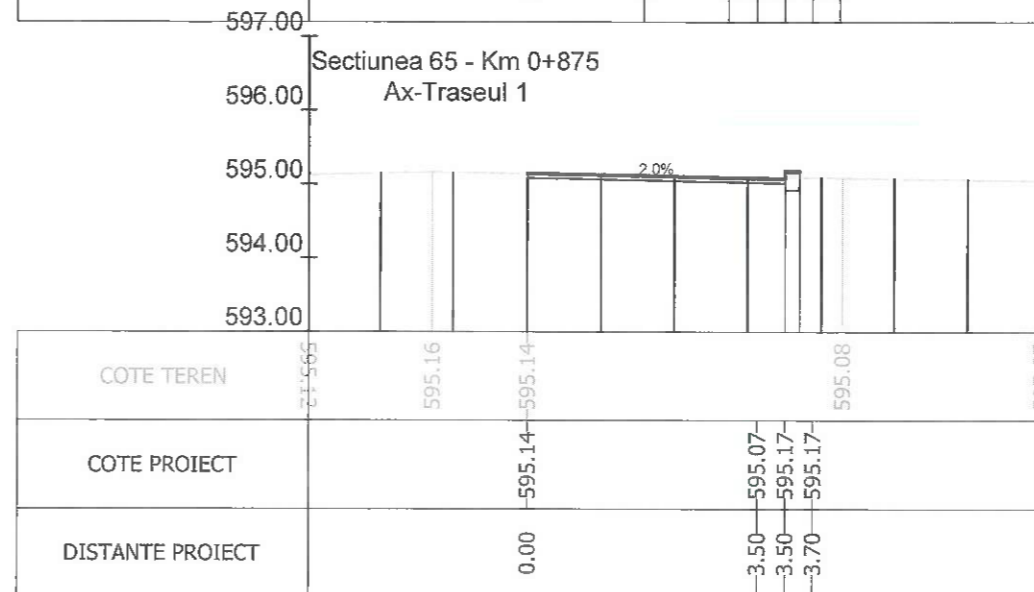

Sectiunea 67 - Km 0+900
Ax-Traseul 1

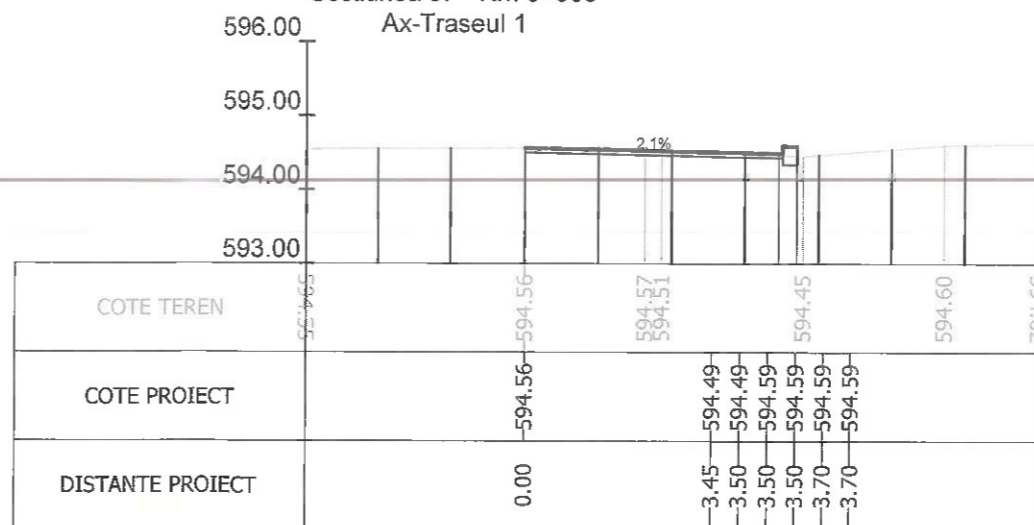

Sectiunea 69 - Km 0+944.692
Ax-Traseul 1

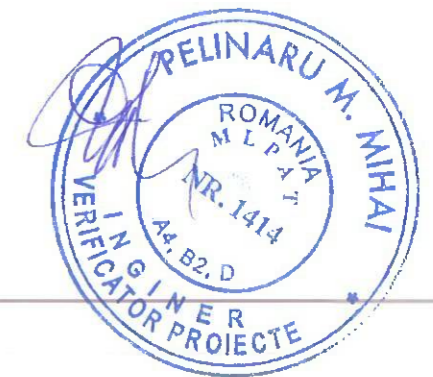

Index	Data	Observatii	Rev. 5
A			
		Beneficiar:	MUNICIPIUL BRASOV Bulevardul Eroilor 8, Brasov 500007
		Titlu proiect:	AMENAJARE BENZI DEDICATE TRANSPORTULUI PUBLIC IN MUNICIPIUL BRASOV SI TROTUARE ADIACENTE
		Titlu plansa:	PROFILE TRANSVERSALE CURENTE
Sef Proiect	Ing. A. Buta	Nr. proiect	73 / 2020
Proiectat	Ing. A. Buta	Faza	P.T.
Desenat	Ing. S. Patroi	Nr. plansa	PT-09
Verificat		Scara	1/100
		Data	07/2023

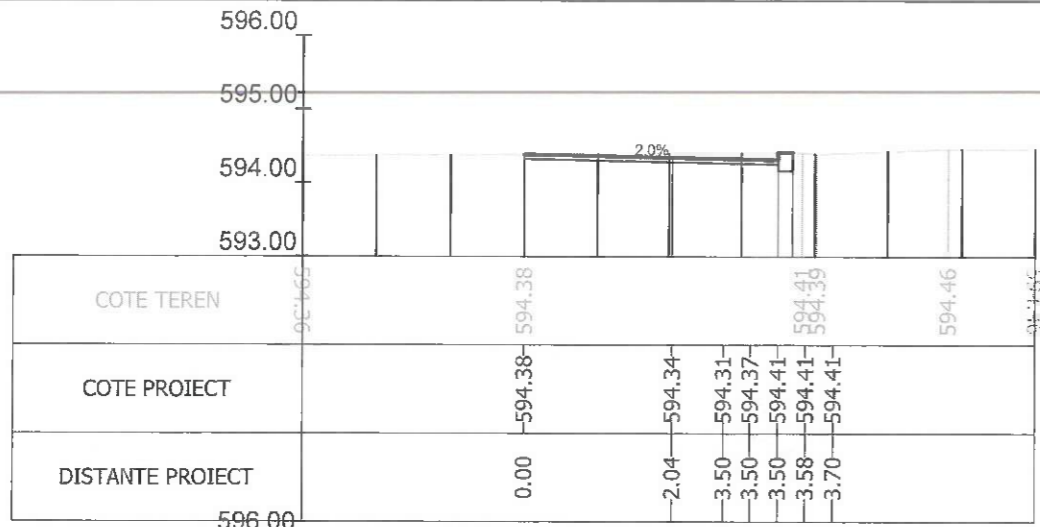

Sectiunea 70 - Km 0+950
Ax-Traseul 1

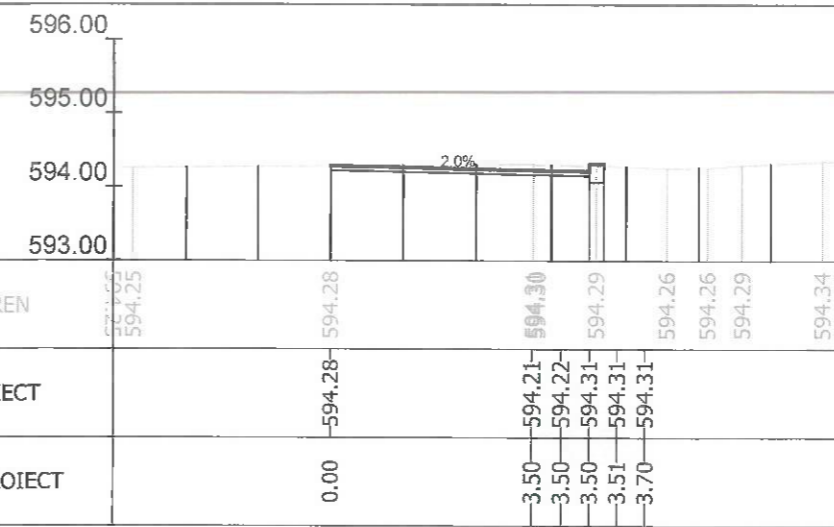
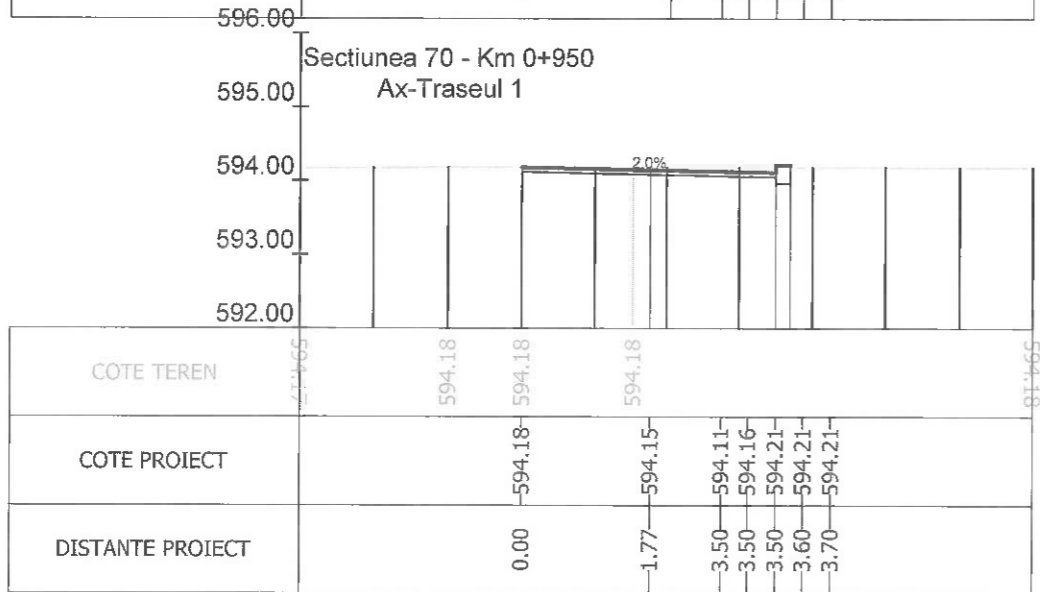

Sectiunea 71 - Km 0+957.321
Ax-Traseul 1

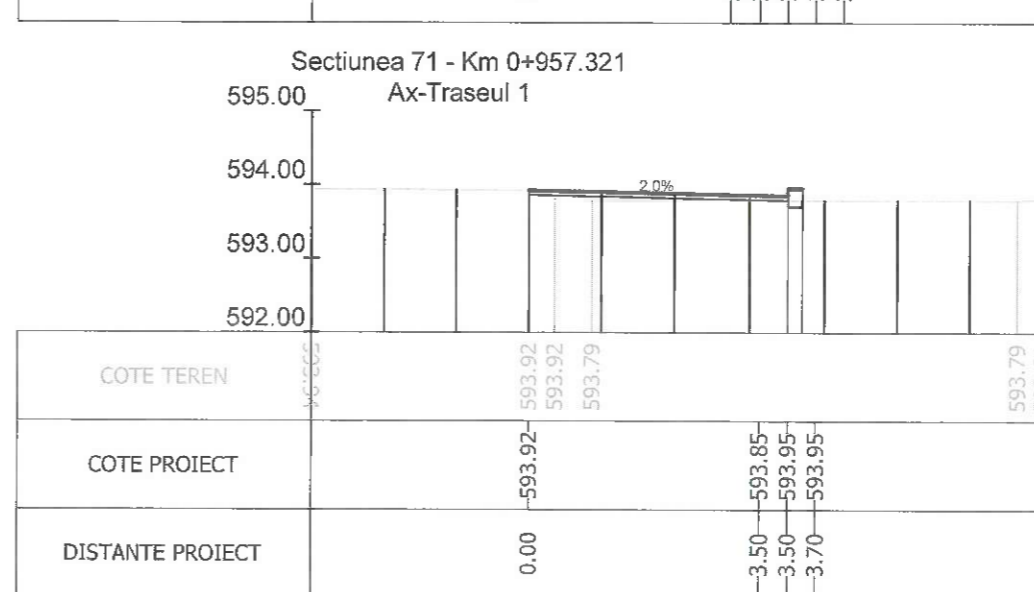

Sectiunea 72 - Km 1+000
Ax-Traseul 1

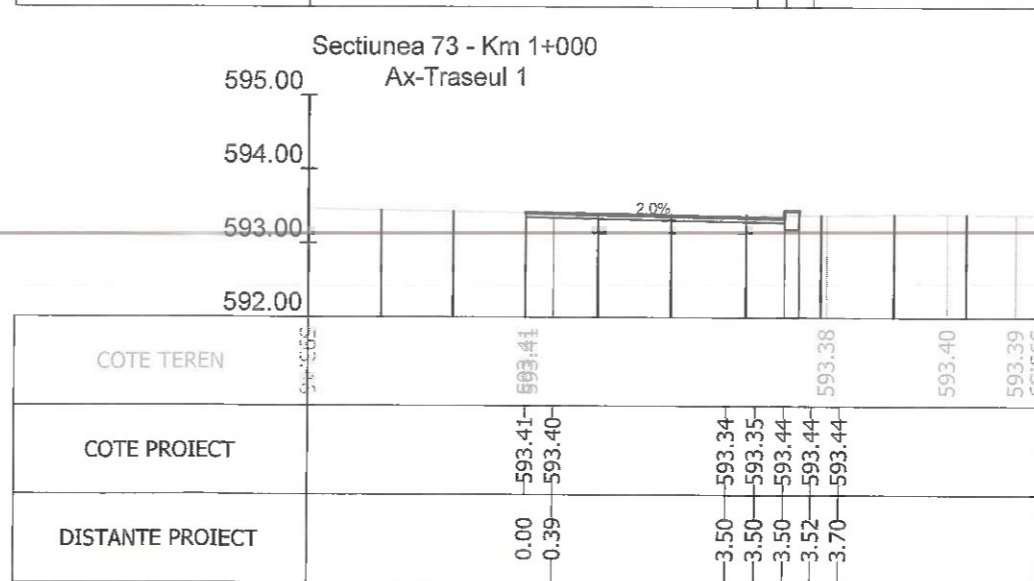

Sectiunea 73 - Km 1+025
Ax-Traseul 1

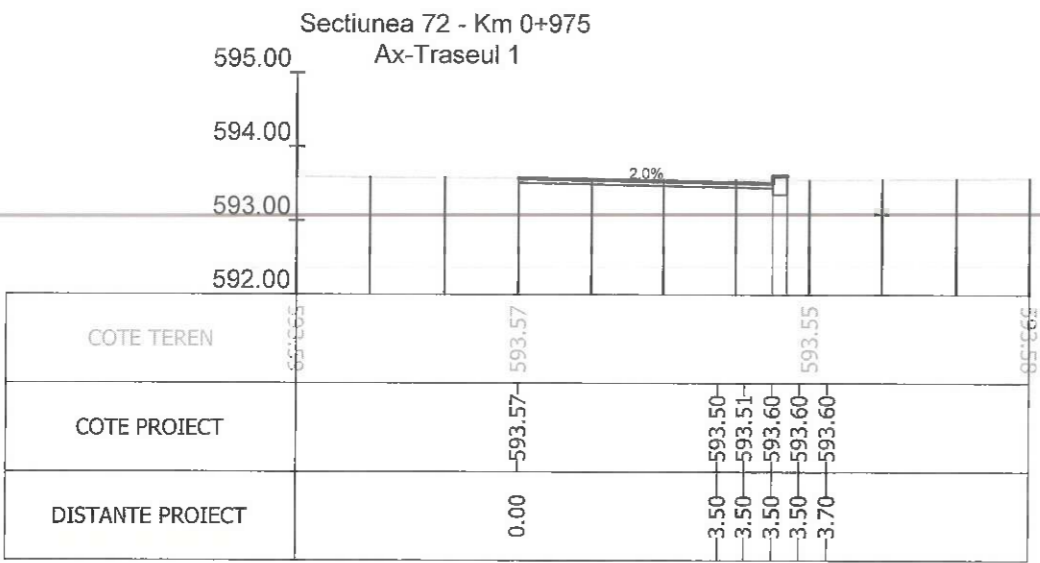

Sectiunea 74 - Km 1+018.513
Ax-Traseul 1



Index	Data	Rev. 5
A		
		Beneficiar: MUNICIPIUL BRASOV Bulevardul Eroilor 8, Brasov 500007
Sef Proiect	Ing. A. Buta	Nr. proiect 73 / 2020
Proiectat	Ing. A. Buta	Titlu proiect: AMENAJARE BENZI DEDICATE TRANSPORTULUI PUBLIC IN MUNICIPIUL BRASOV SI TROTUARE ADIACENTE
Desenat	Ing. S. Patroi	Faza P.T.
Verificat		Titlu plansa: PROFILE TRANSVERSALE CURENTE
	Scara 1/100	Nr. plansa PT-10
	Data 07/2023	

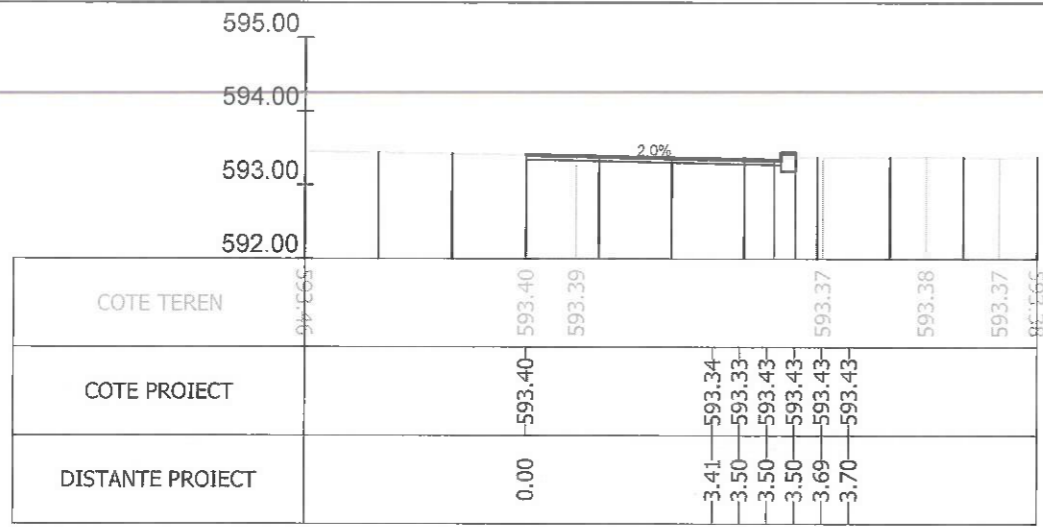

Sectiunea 76 - Km 1+025.562
Ax-Traseul 1

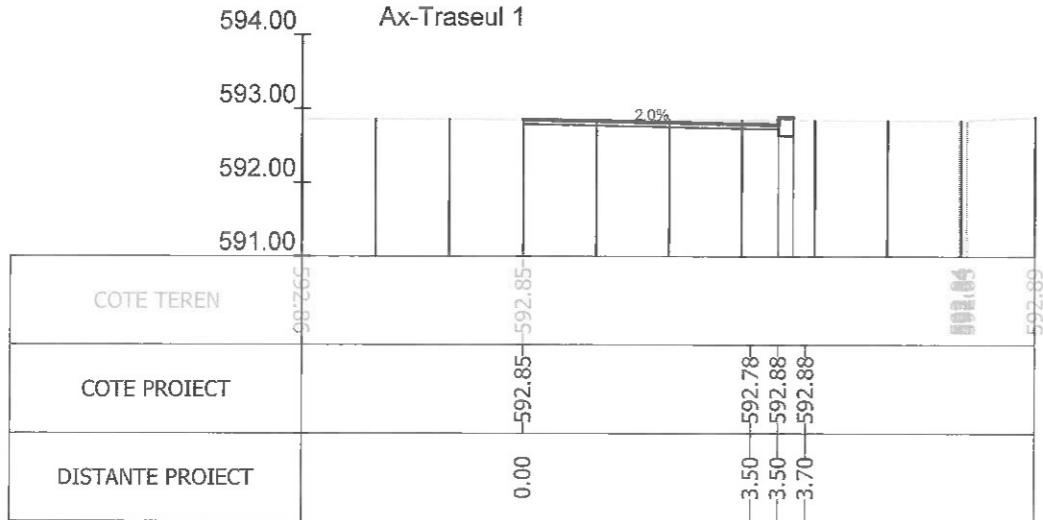

Sectiunea 78 - Km 1+058.629
Ax-Traseul 1

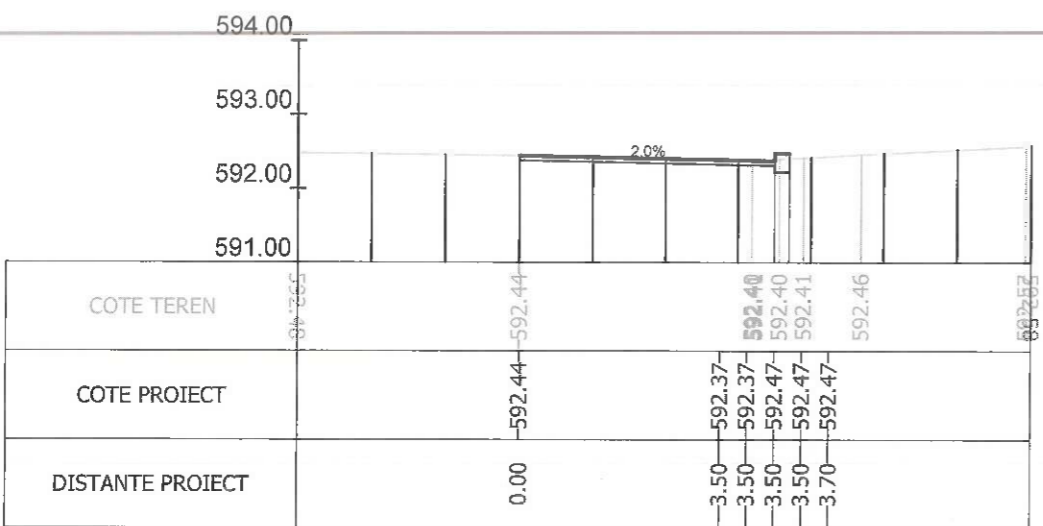

Sectiunea 80 - Km 1+087.394
Ax-Traseul 1

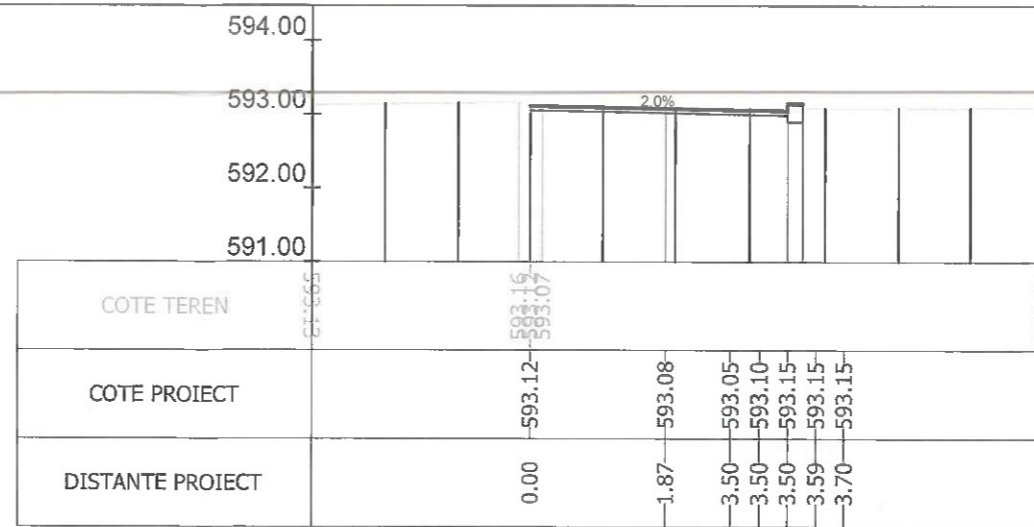

Sectiunea 77 - Km 1+050
Ax-Traseul 1

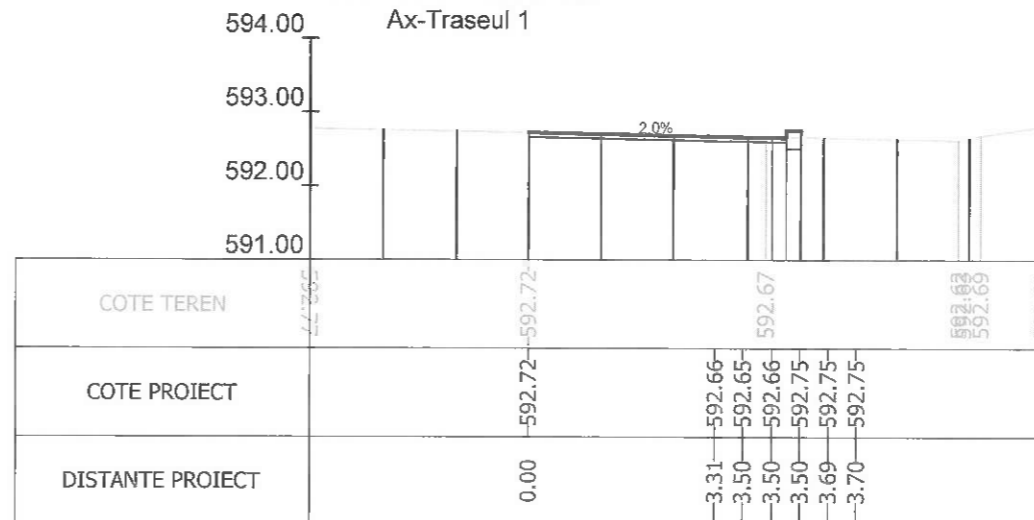

Sectiunea 79 - Km 1+075
Ax-Traseul 1

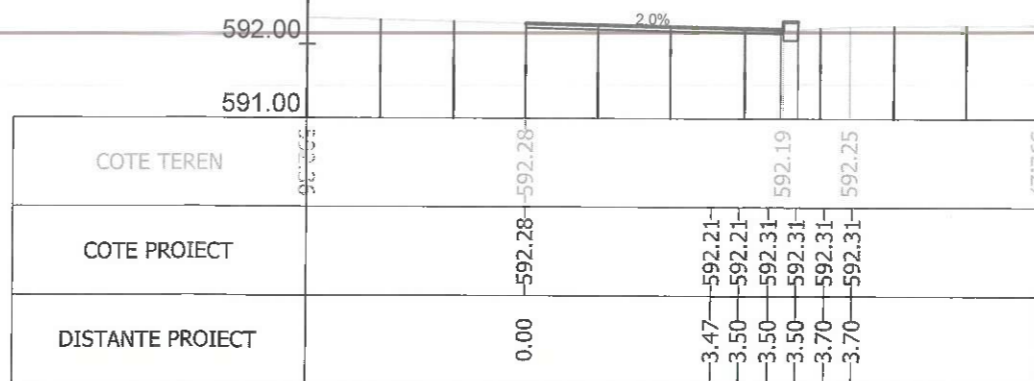

Sectiunea 81 - Km 1+098.634
Ax-Traseul 1

Index	Detalii	Rev. 5
A		
		Beneficiar: MUNICIPIUL BRASOV Bulevardul Eroilor 8, Brasov 500007
Sef Proiect: Ing. A. Buta Proiectat: Ing. A. Buta Desenat: Ing. S. Patroi Verificat:		Nr. proiect: 73 / 2020 Faza: P.T.
Scara: 1/100 Data: 07/2023		Nr. planşa: PT-11
Titlu proiect: AMENAJARE BENZI DEDICATE TRANSPORTULUI PUBLIC IN MUNICIPIUL BRASOV SI TROTUARE ADIACENTE		Titlu planşa: PROFILE TRANSVERSALE CURENTE

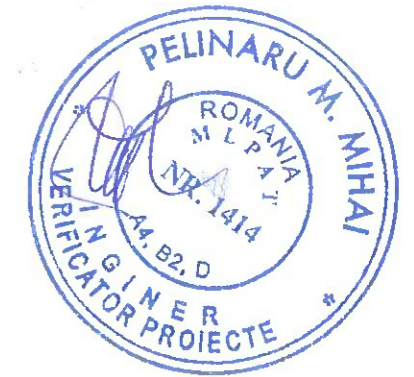

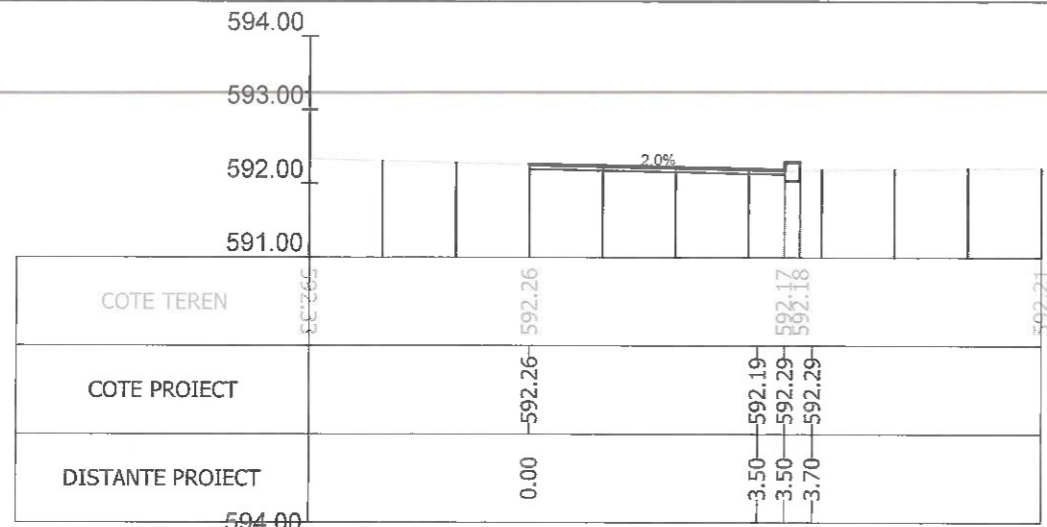

Sectiunea 82 - Km 1+100
Ax-Traseul 1

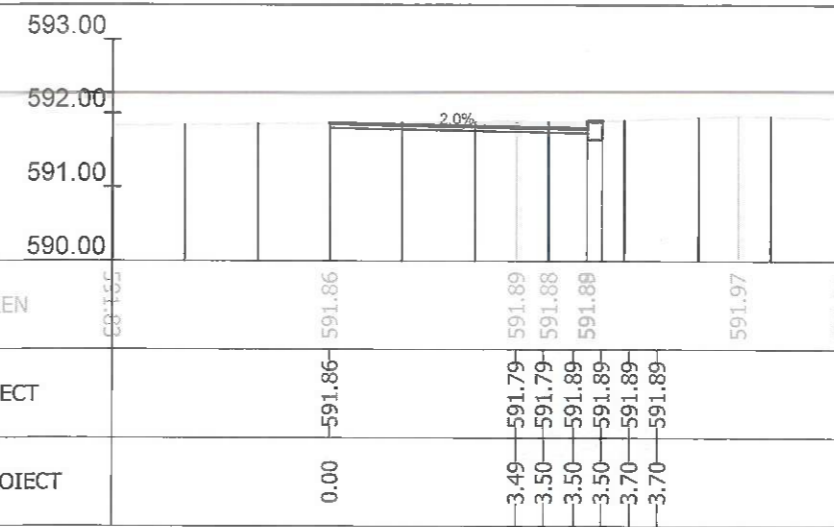
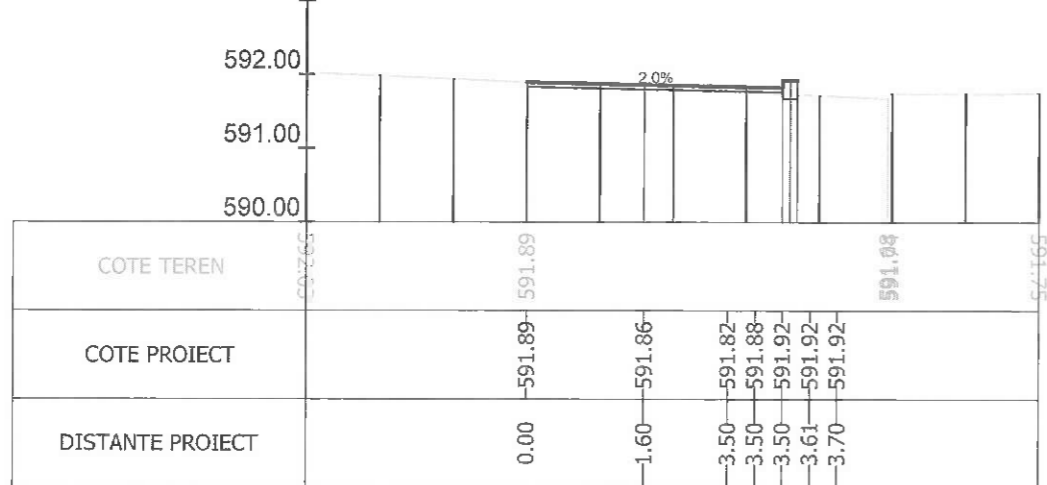

Sectiunea 83 - Km 1+114.550
Ax-Traseul 1

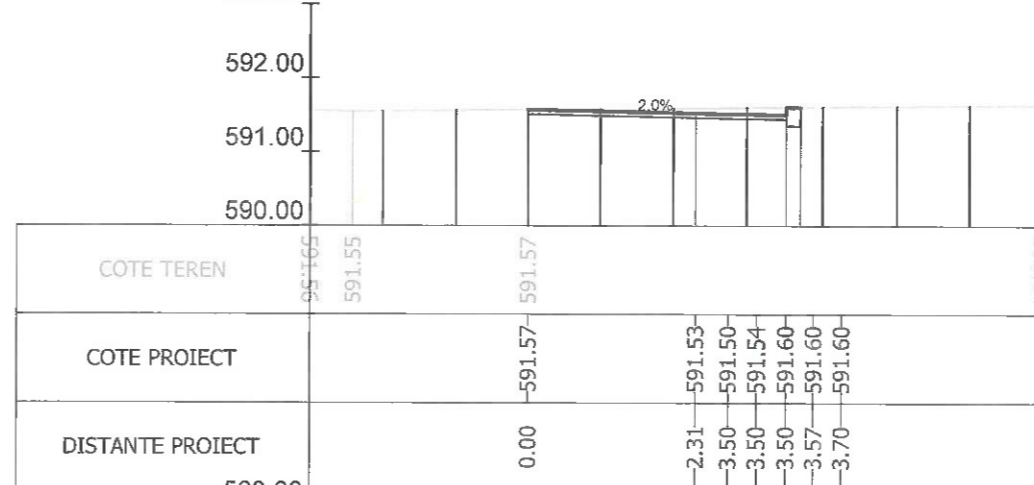

Sectiunea 84 - Km 1+125
Ax-Traseul 1

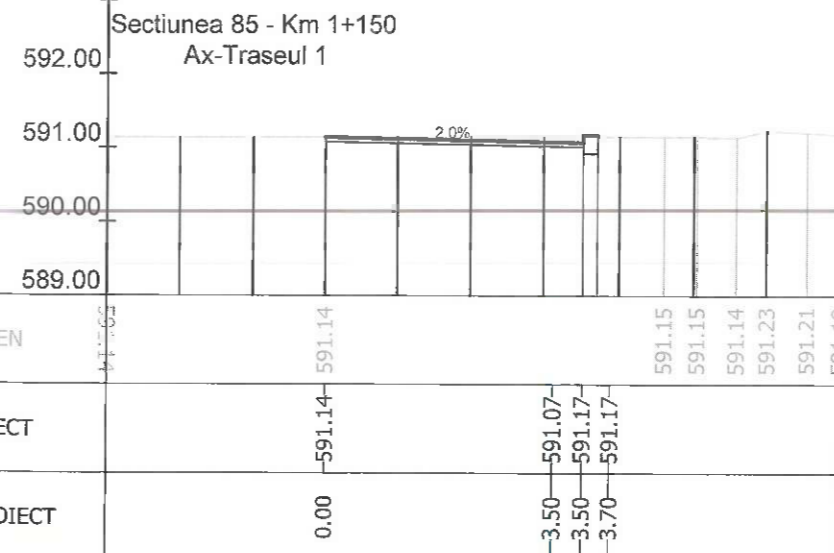
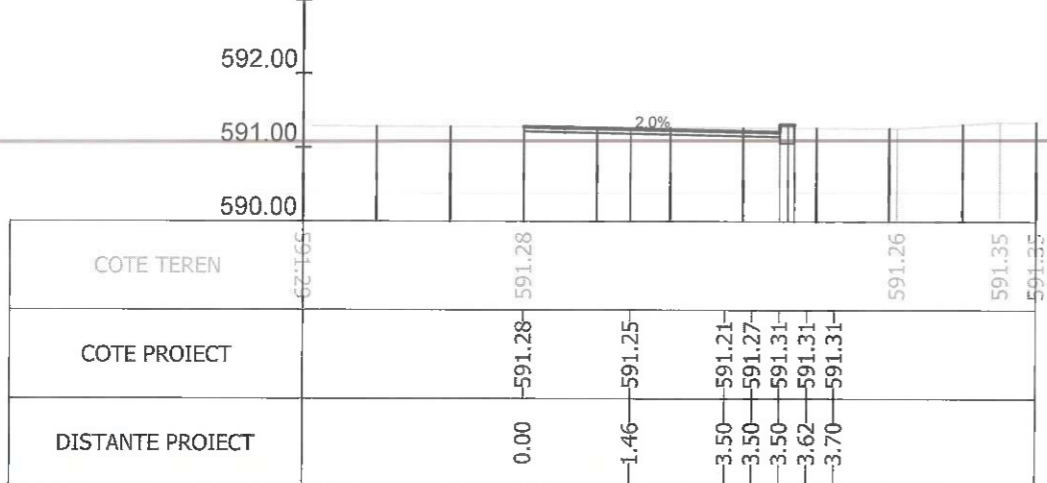

Sectiunea 85 - Km 1+150
Ax-Traseul 1

Sectiunea 86 - Km 1+175
Ax-Traseul 1

Index	Data	Rev. 5
A		
		Beneficiar: MUNICIPIUL BRASOV Bulevardul Eroilor 8, Brasov 500007
Sef Proiect	Ing. A. Buta	Nr. proiect 73 / 2020
Proiectat	Ing. A. Buta	Titlu proiect: AMENAJARE BENZI DEDICATE TRANSPORTULUI PUBLIC IN MUNICIPIUL BRASOV SI TROTUARE ADIACENTE
Desenat	Ing. S. Patroi	Faza P.T.
Verificat		Titlu plansa: PROFILE TRANSVERSALE CURENTE
Scara 1/100		Nr. plansa PT-12
Data 07/2023		

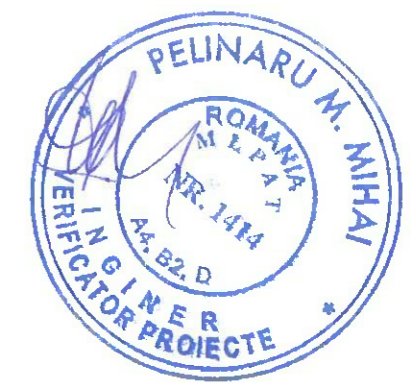

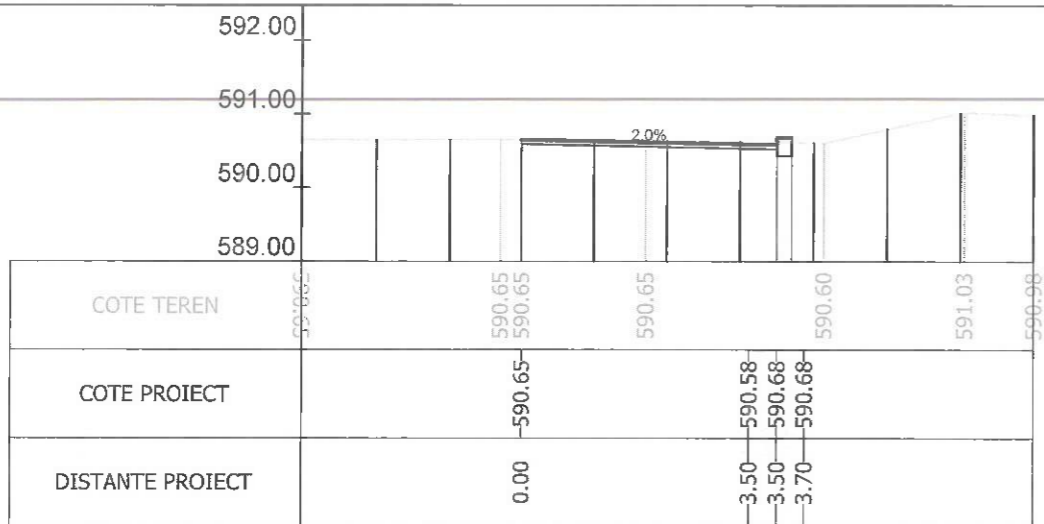

Sectiunea 88 - Km 1+200
Ax-Traseul 1

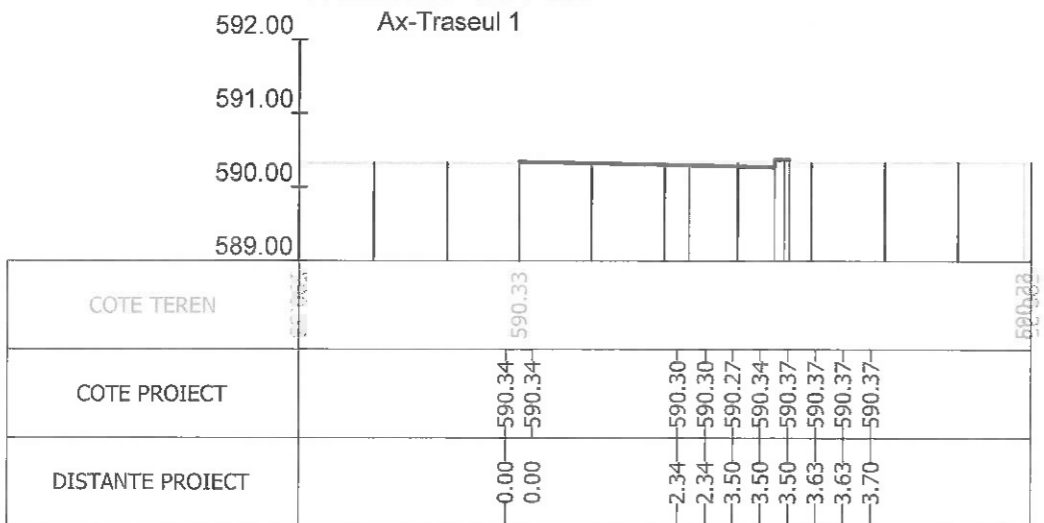

Sectiunea 89 - Km 1+209.826
Ax-Traseul 1

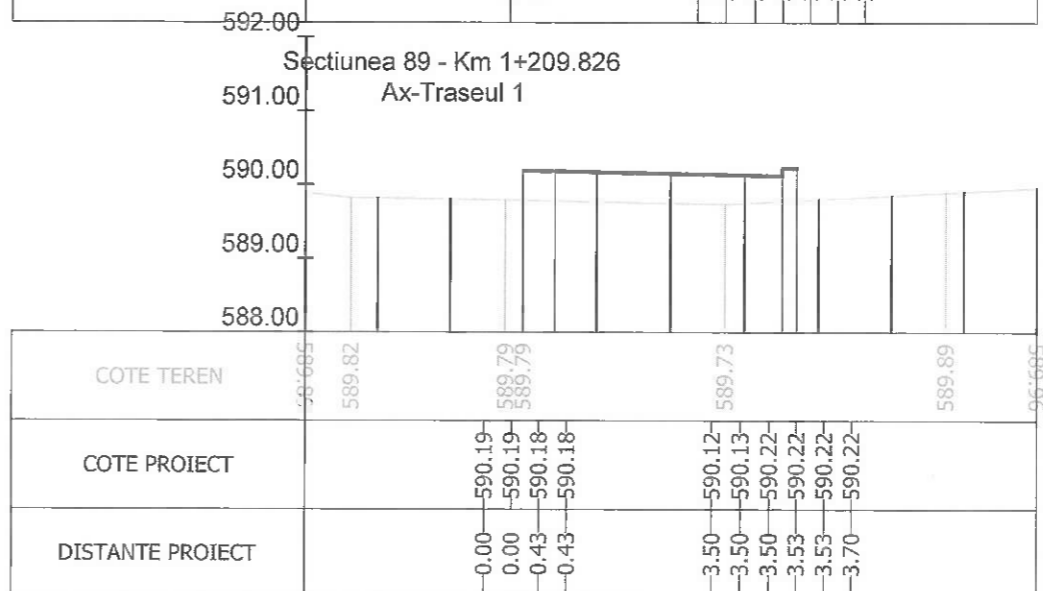

Sectiunea 90 - Km 1+225
Ax-Traseul 1

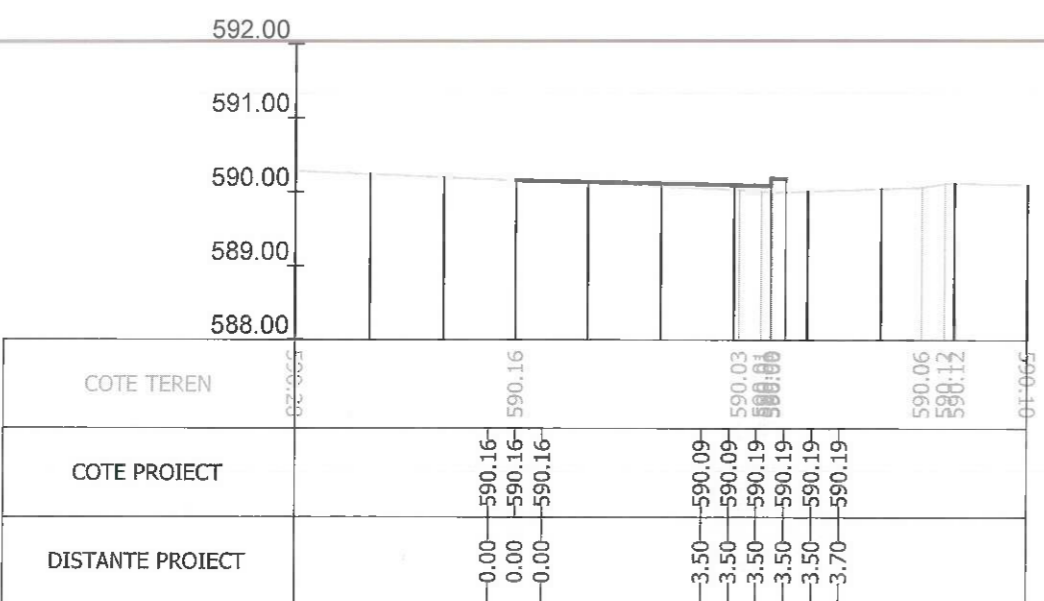

Sectiunea 91 - Km 1+250
Ax-Traseul 1

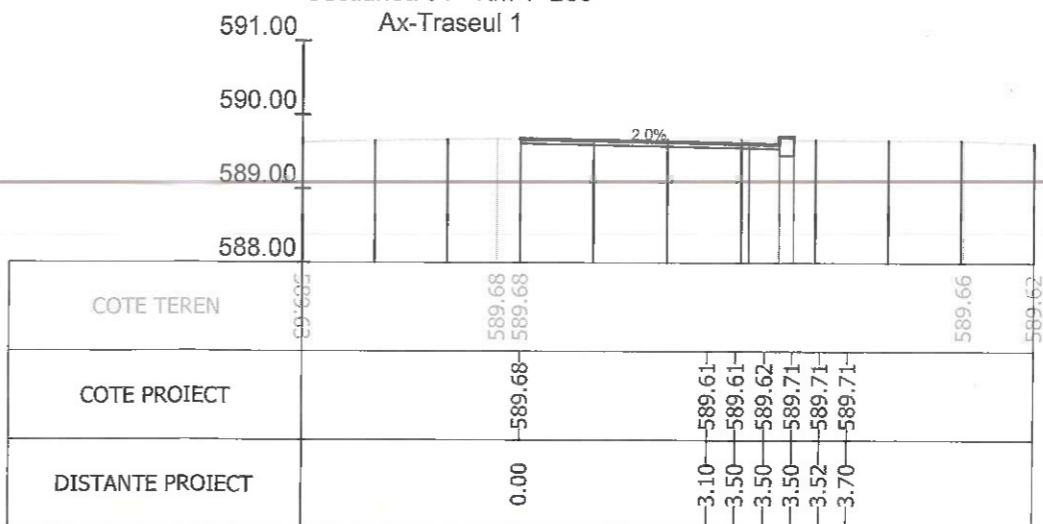

Sectiunea 92 - Km 1+255.707
Ax-Traseul 1

Sectiunea 93 - Km 1+275
Ax-Traseul 1

Index	Data	Observatii	Rev. 5
A			
		Beneficiar:	MUNICIPIUL BRASOV Bulevardul Eroilor 8, Brasov 500007
		Titlu proiect:	AMENAJARE BENZI DEDICATE TRANSPORTULUI PUBLIC IN MUNICIPIUL BRASOV SI TROTUARE ADIACENTE
		Titlu plansa:	PROFILI TRANSVERSALE CURENTE
Sef Proiect	Ing. A. Buta	Scara	Nr. proiect
Proiectat	Ing. A. Buta	1/100	73 / 2020
Desenat	Ing. S. Patroi	Data	Faza
Verificat		07/2023	P.T.
			Nr. plansa
			PT-13



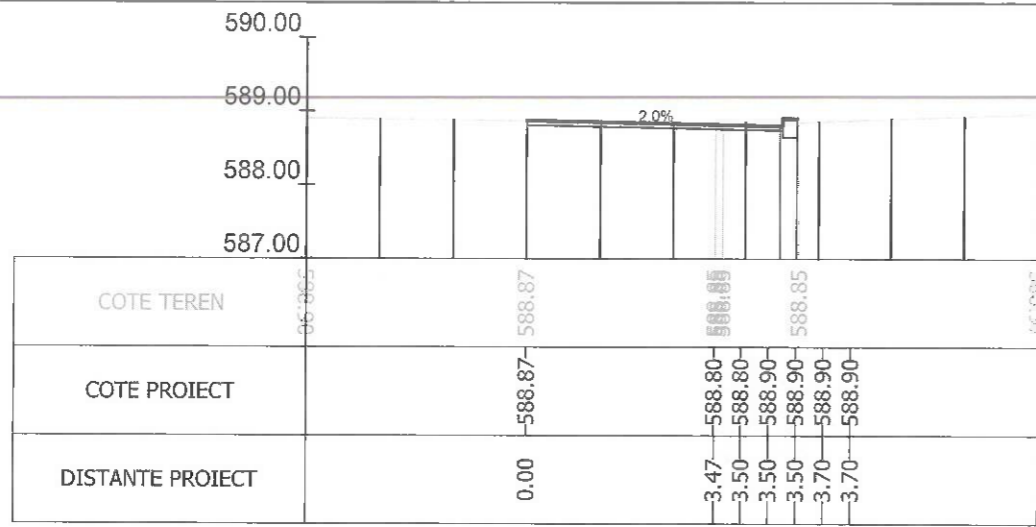

Sectiunea 94 - Km 1+296.601
Ax-Traseul 1

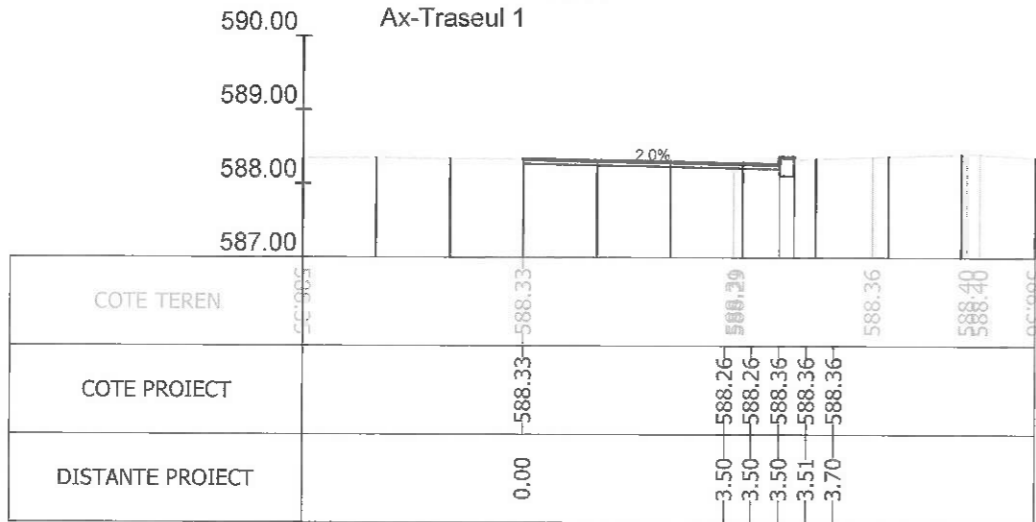

Sectiunea 96 - Km 1+312.640
Ax-Traseul 1

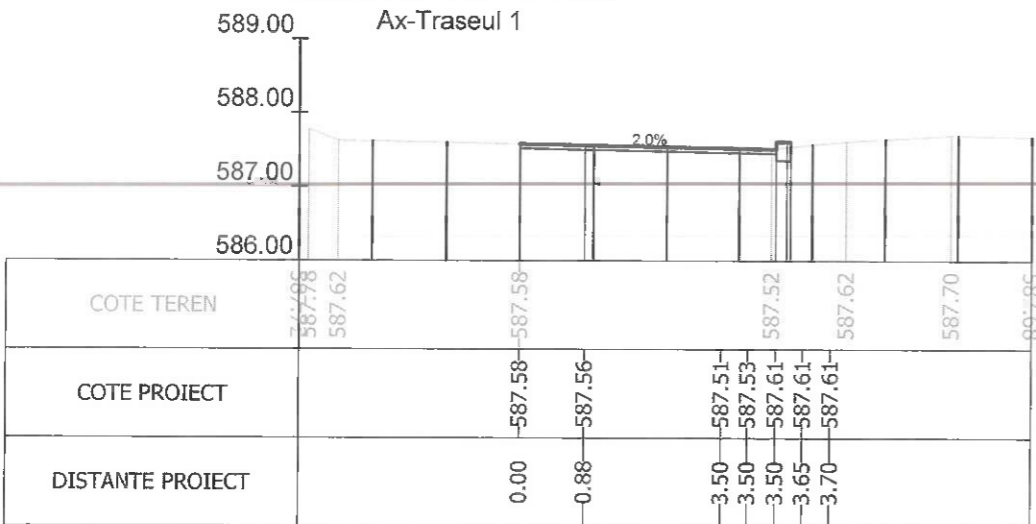

Sectiunea 98 - Km 1+350
Ax-Traseul 1

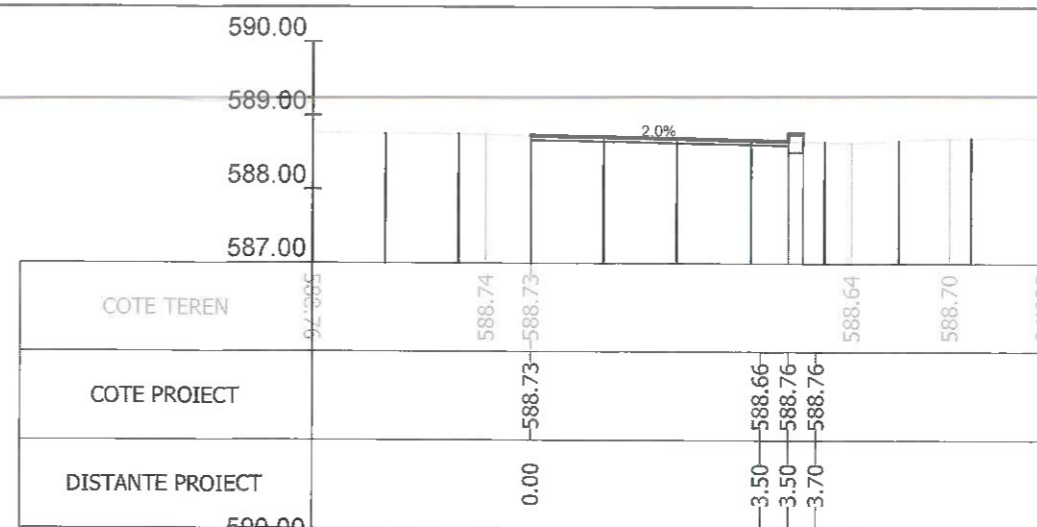

Sectiunea 95 - Km 1+300
Ax-Traseul 1

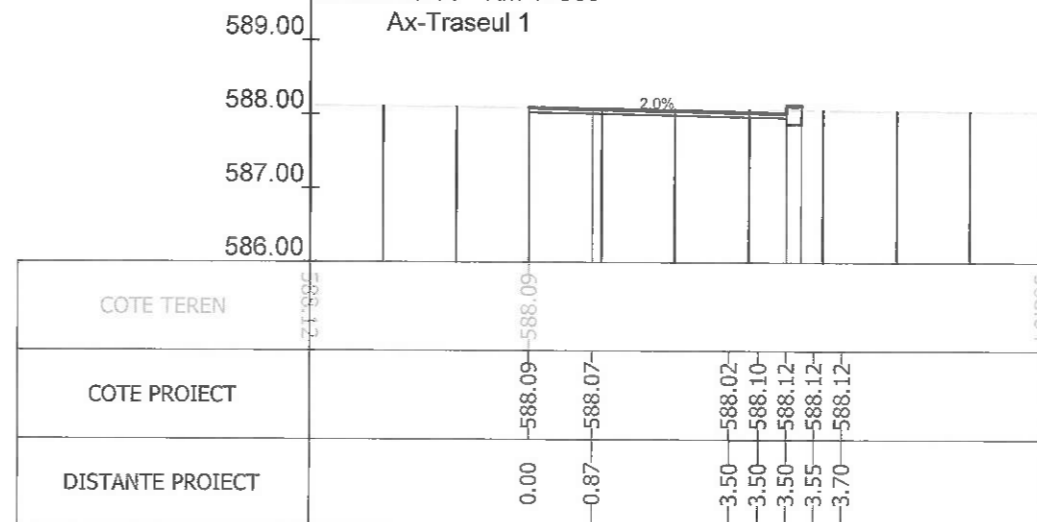

Sectiunea 97 - Km 1+325
Ax-Traseul 1

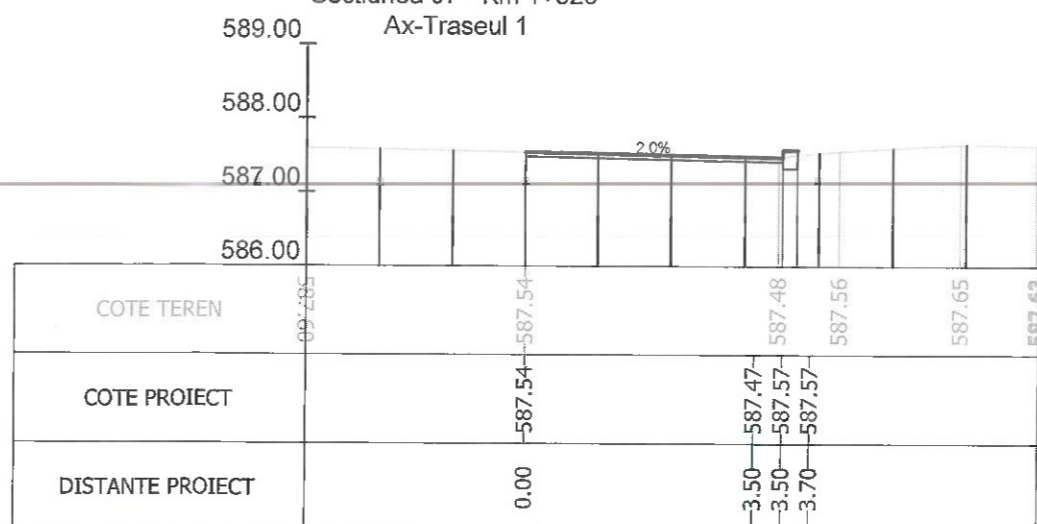

Sectiunea 99 - Km 1+352.437
Ax-Traseul 1

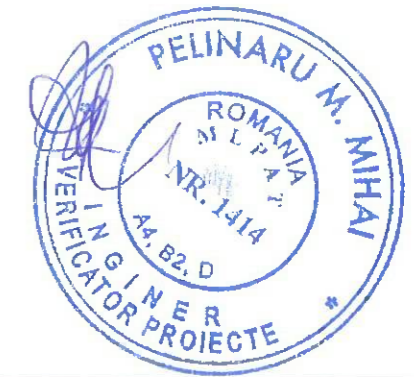

Index	Ax-Traseul 1		Rev. 5
A			
		Beneficiar:	MUNICIPIUL BRASOV Bulevardul Eroilor 8, Brasov 500007
Sef Proiect Proiectat Desenat Verificat		Nr. proiect 73 / 2020 Faza P.T. Nr. plansa PT-14	
Ing. A. Buta Ing. A. Buta Ing. S. Patroi		Titlu proiect: AMENAJARE BENZI DEDICATE TRANSPORTULUI PUBLIC IN MUNICIPIUL BRASOV SI TROTUARE ADIACENTE	
Scara 1/100 Data 07/2023		Titlu plansa: PROFILE TRANSVERSALE CURENTE	

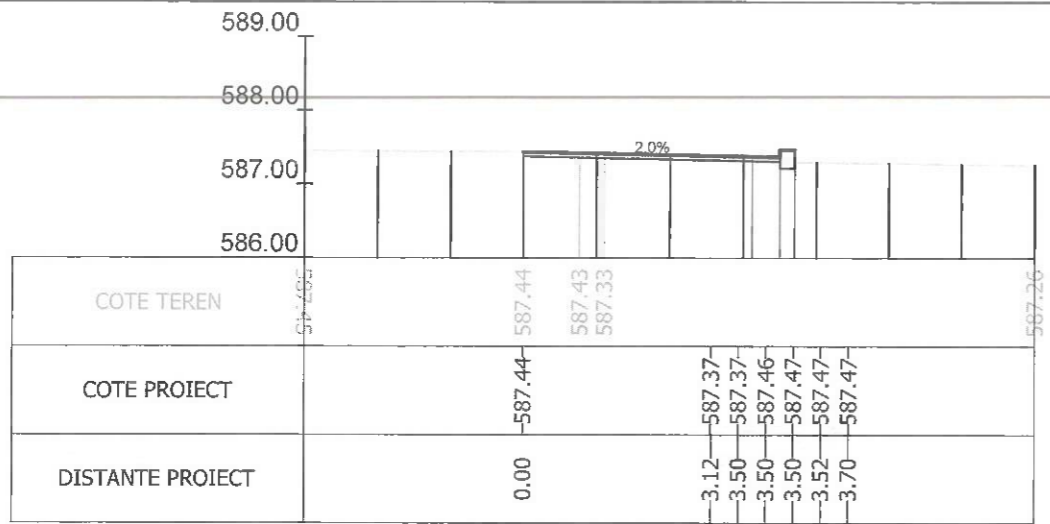

Sectiunea 100 - Km 1+375
Ax-Traseul 1

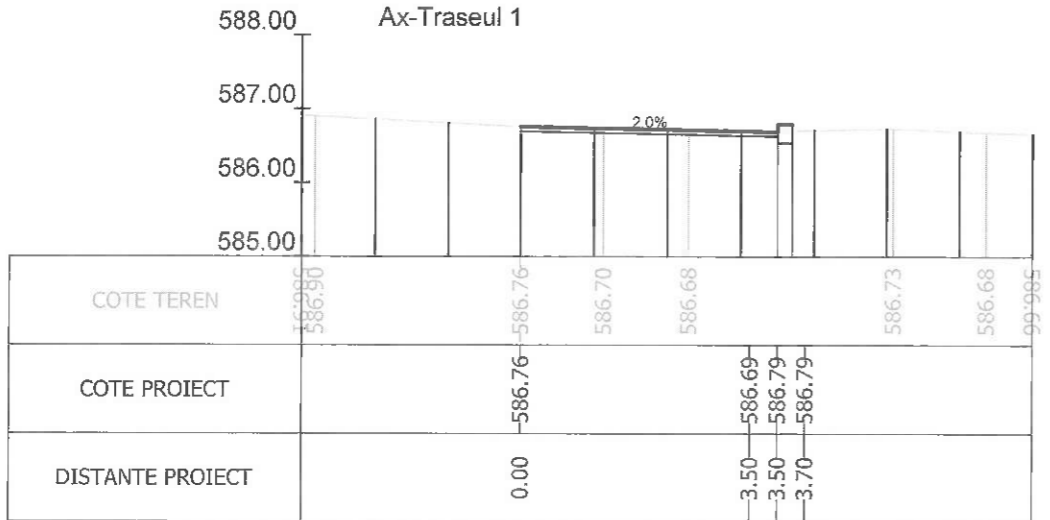

Sectiunea 102 - Km 1+400
Ax-Traseul 1

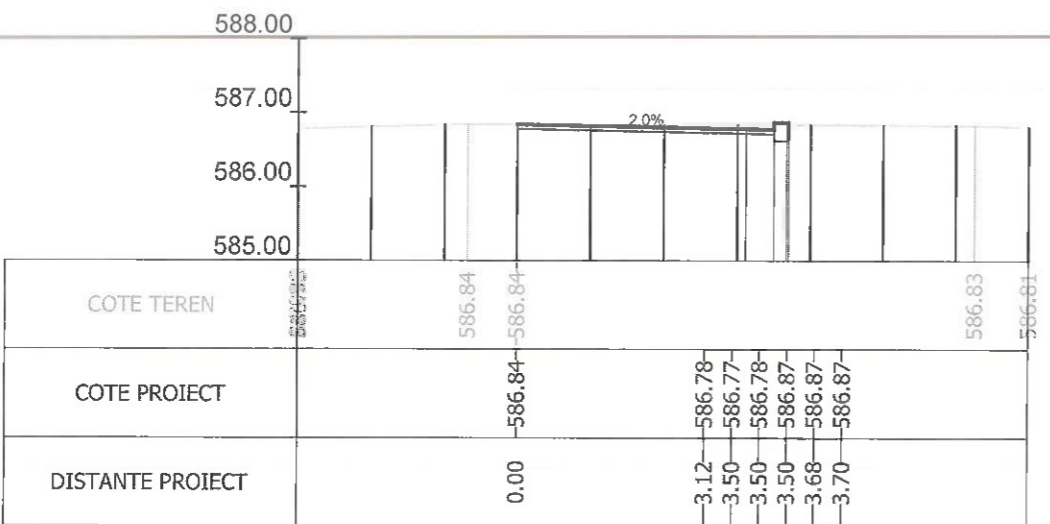

Sectiunea 104 - Km 1+425
Ax-Traseul 1

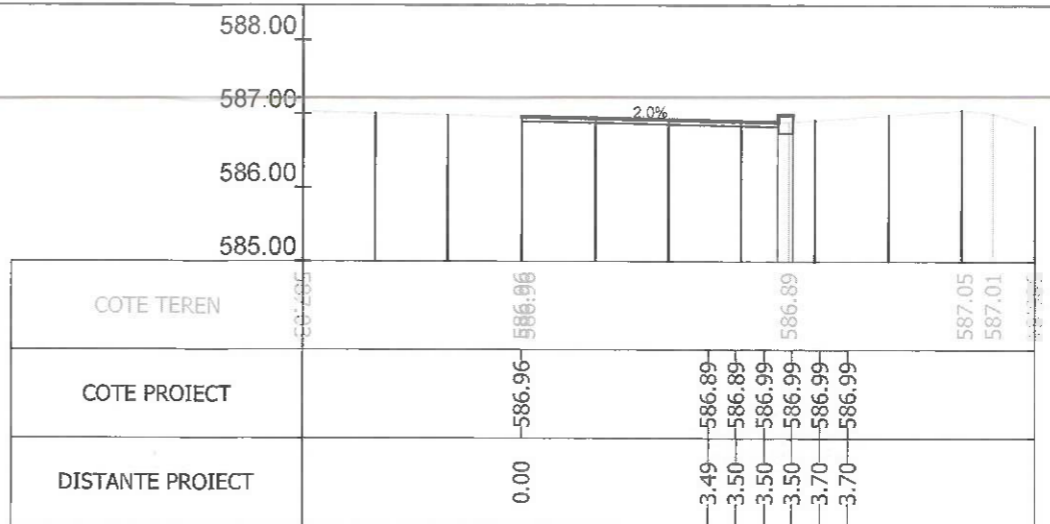

Sectiunea 101 - Km 1+392.440
Ax-Traseul 1

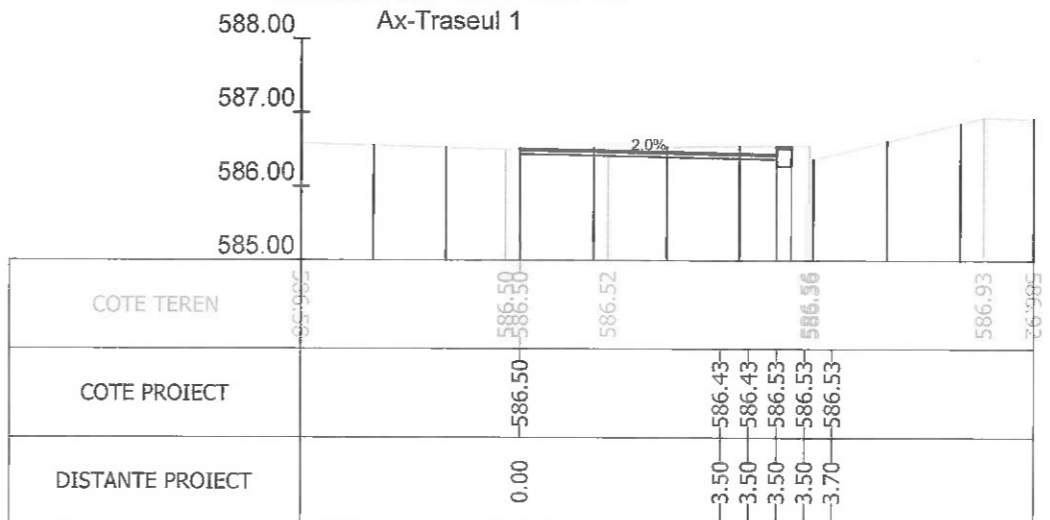

Sectiunea 103 - Km 1+408.577
Ax-Traseul 1

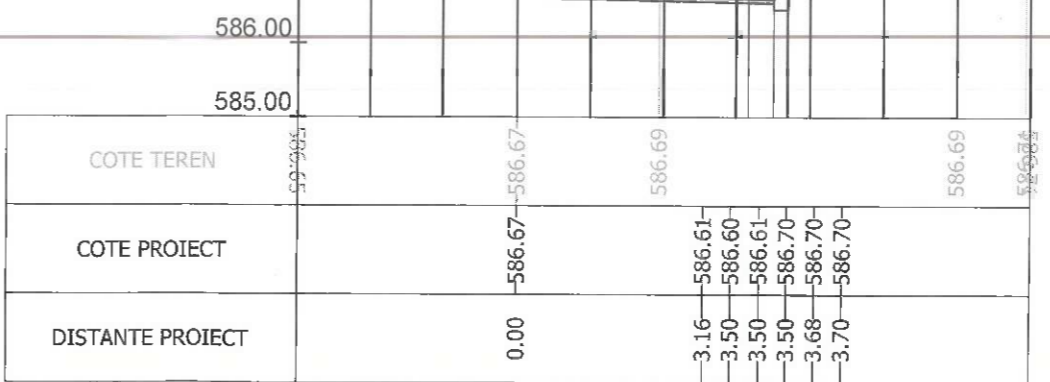

Sectiunea 105 - Km 1+450
Ax-Traseul 1

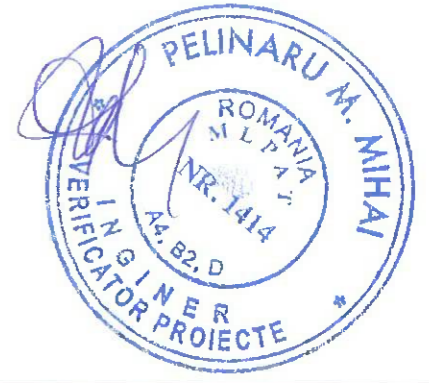

Index	Ax-Traseul 1		Rev. 5
A			
		Beneficiar:	MUNICIPIUL BRASOV Bulevardul Eroilor 8, Brasov 500007
Sef Proiect: Ing. A. Buta Proiectat: Ing. A. Buta Desenat: Ing. S. Patroi Verificat:		Nr. proiect	73 / 2020
Scara: 1/100		Titlu proiect:	AMENAJARE BENZI DEDICATE TRANSPORTULUI PUBLIC IN MUNICIPIUL BRASOV SI TROTUARE ADIACENTE
Data: 07/2023		Titlu plansa:	PROFILE TRANSVERSALE CURENTE
		Nr. plansa	PT-15

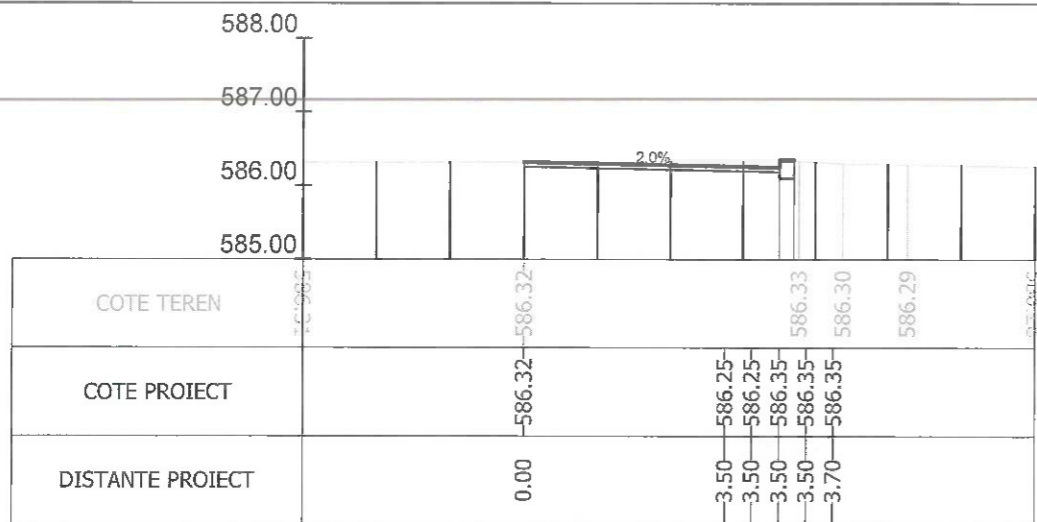

Sectiunea 106 - Km 1+472.530

Ax-Traseul 1

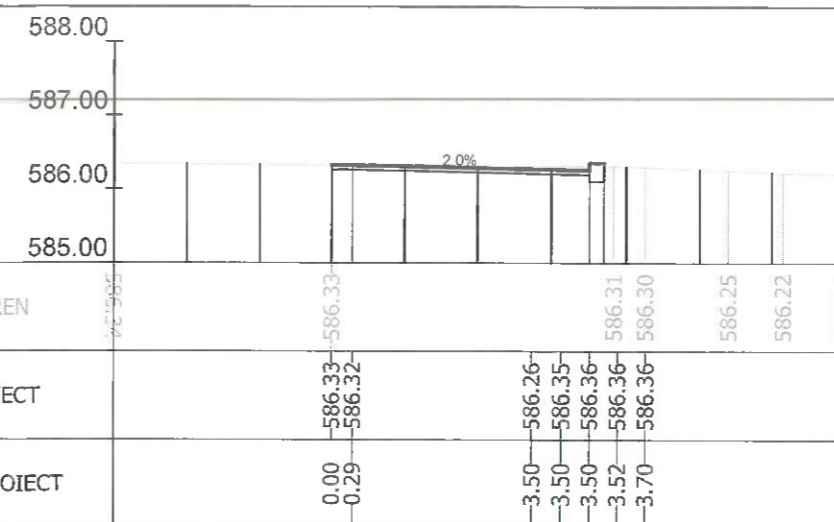
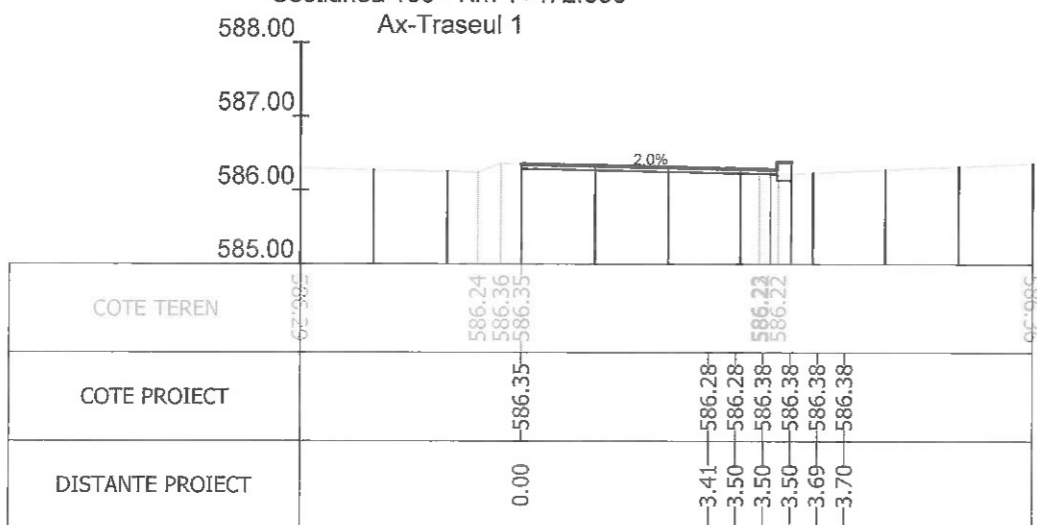

Sectiunea 107 - Km 1+475

Ax-Traseul 1

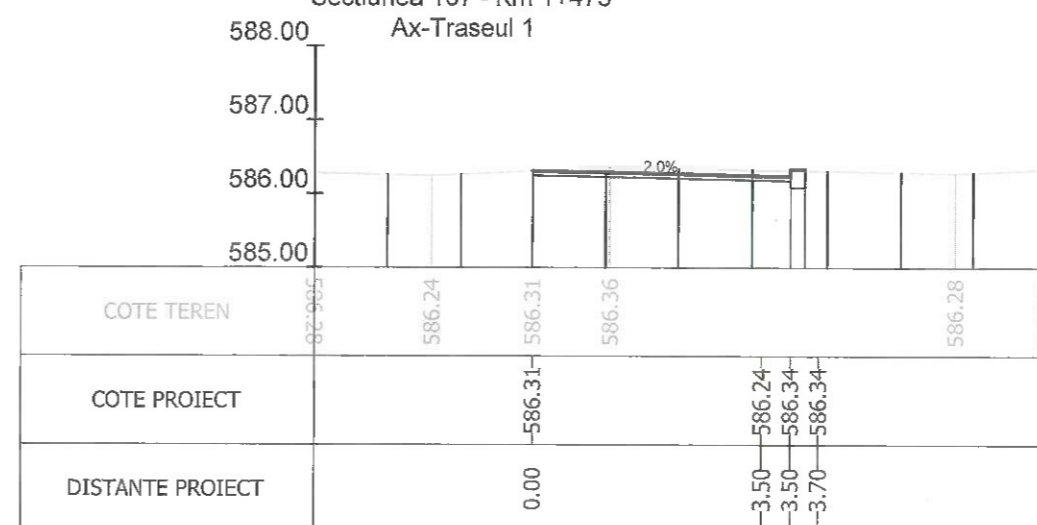

Sectiunea 108 - Km 1+486.737

Ax-Traseul 1

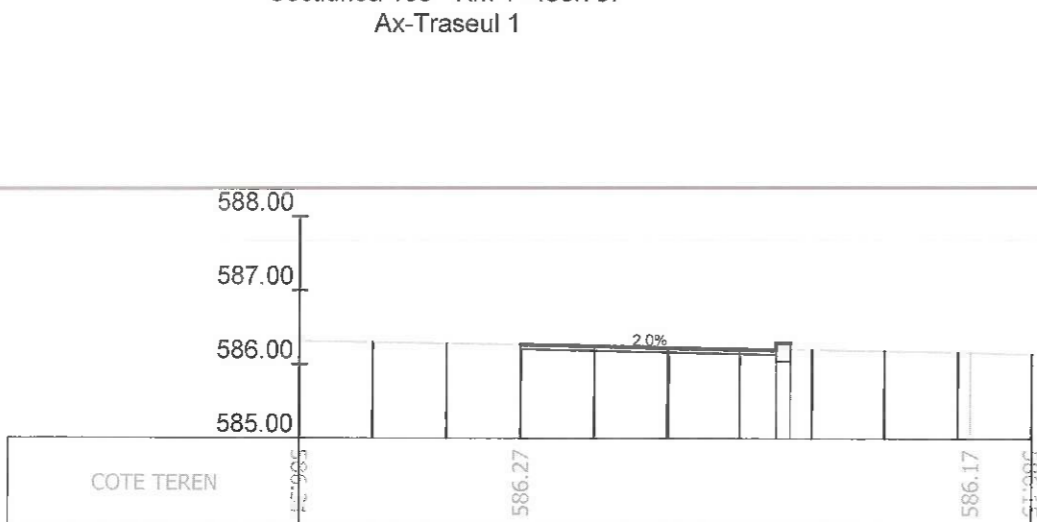

Sectiunea 109 - Km 1+500

Ax-Traseul 1

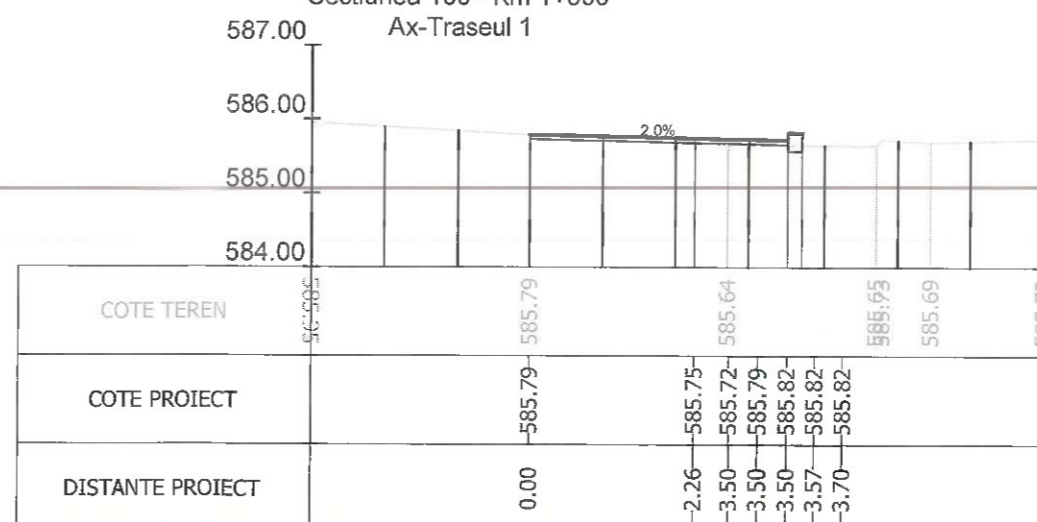

Sectiunea 110 - Km 1+525

Ax-Traseul 1

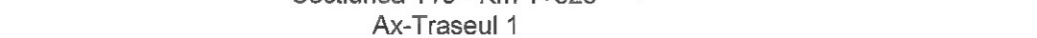

Sectiunea 111 - Km 1+550

Index	Data	Observatii	Rev. 5
A			
 HENTZA BUSINESS <small>www.hentza.ro</small>			Beneficiar:
			MUNICIPIUL BRASOV Bulevardul Eroilor 8, Brasov 500007
Sef Proiect: Ing. A. Buta Proiectat: Ing. A. Buta Desenat: Ing. S. Patroi Verificat:		Scara:	Nr. proiect:
		1/100	73 / 2020
		Data:	Faza:
		07/2023	P.T.
Titlu planşa: PROFILE TRANSVERSALE CURENTE			Nr. planşa:
			PT-16

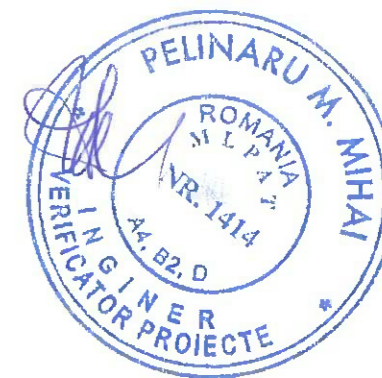

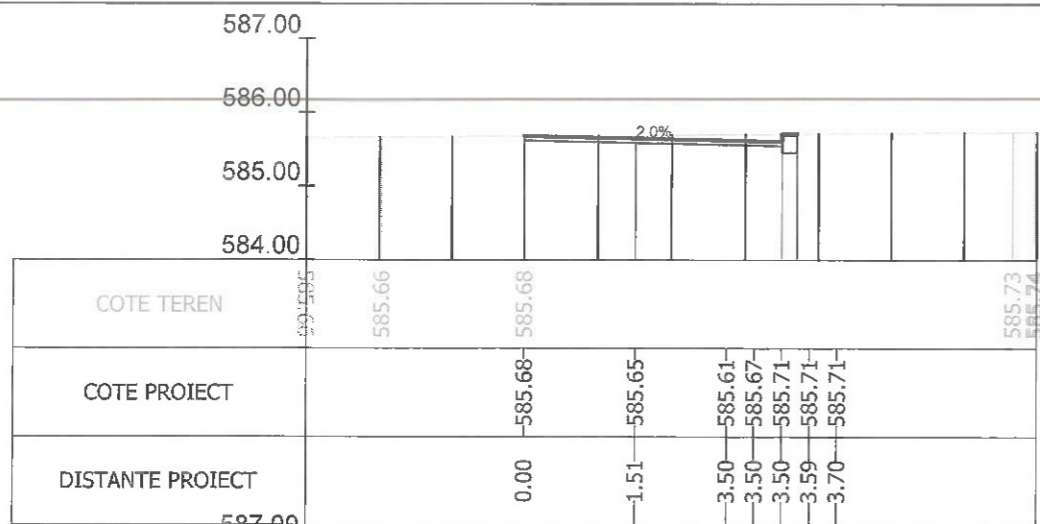

Sectiunea 112 - Km 1+575
Ax-Traseul 1

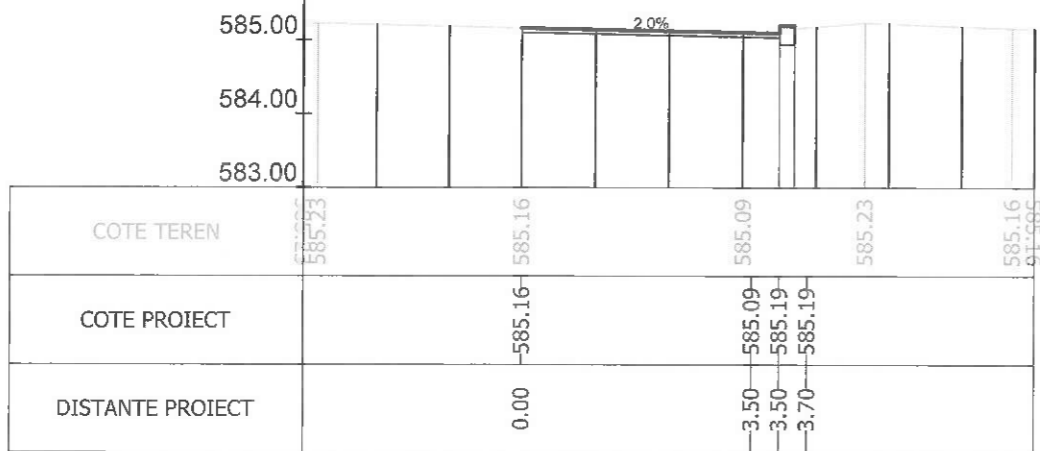

Sectiunea 114 - Km 1+601.136
Ax-Traseul 1

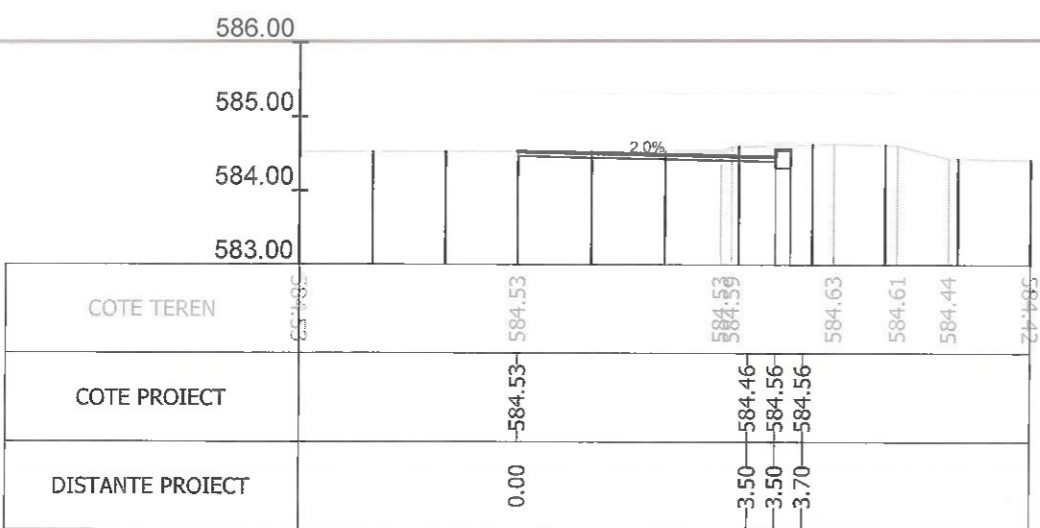

Sectiunea 116 - Km 1+635.090
Ax-Traseul 1

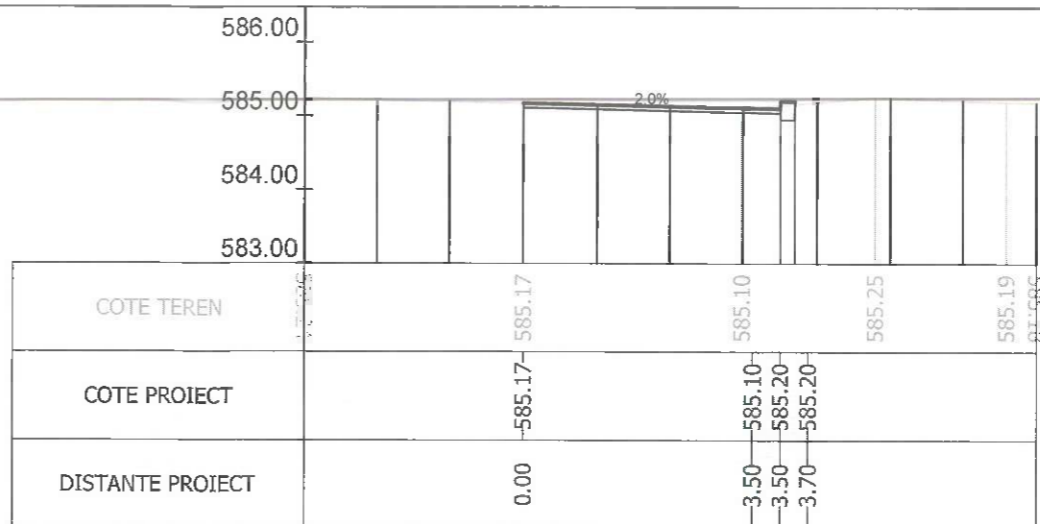

Sectiunea 113 - Km 1+600
Ax-Traseul 1

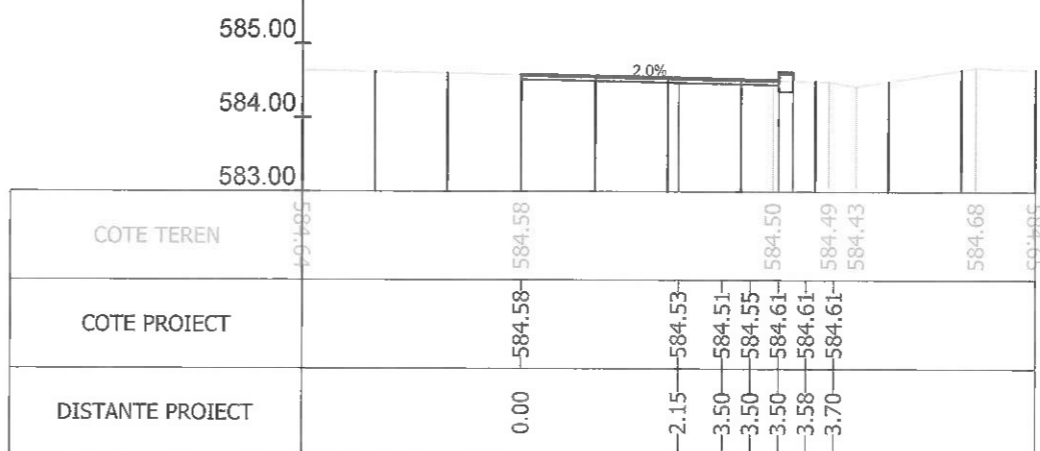

Sectiunea 115 - Km 1+625
Ax-Traseul 1

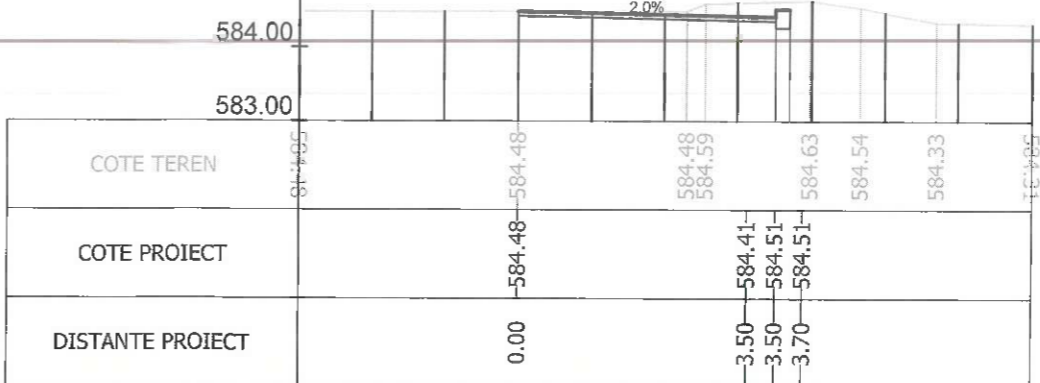

Sectiunea 117 - Km 1+638.111
Ax-Traseul 1



Index	A		Rev. 5
Beneficiar:		MUNICIPIUL BRASOV Bulevardul Eroilor 8, Brasov 500007	Nr. proiect 73 / 2020
Titlu proiect:		AMENAJARE BENZI DEDICATE TRANSPORTULUI PUBLIC IN MUNICIPIUL BRASOV SI TROTUARE ADIACENTE	Faza P.T.
Titlu plansa:		PROFILE TRANSVERSALE CURENTE	Nr. plansa PT-17
Sef Proiect	Ing. A. Buta	Scara 1/100	
Proiectat	Ing. A. Buta	Data	
Desenat	Ing. S. Patroi	07/2023	
Verificat			

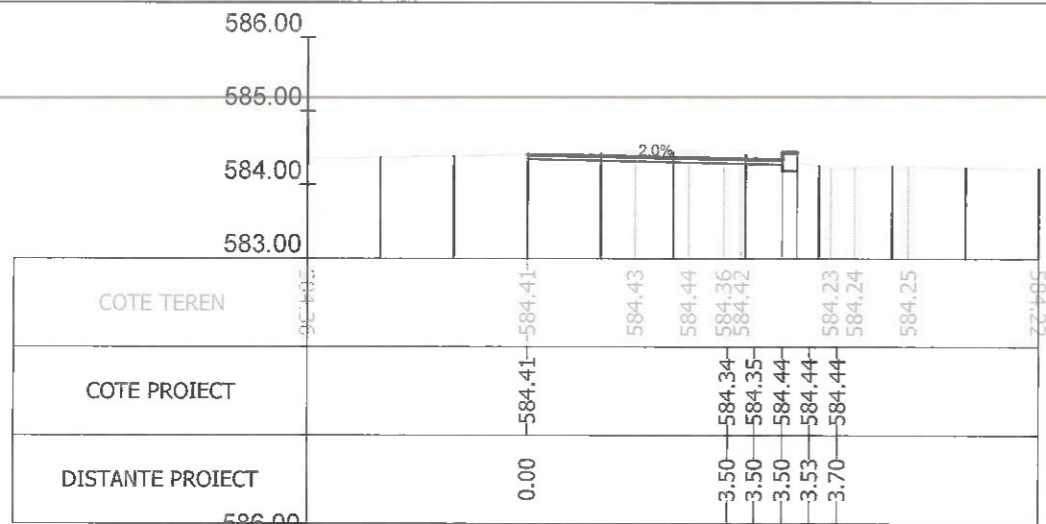

Sectiunea 118 - Km 1+641.115
Ax-Traseul 1

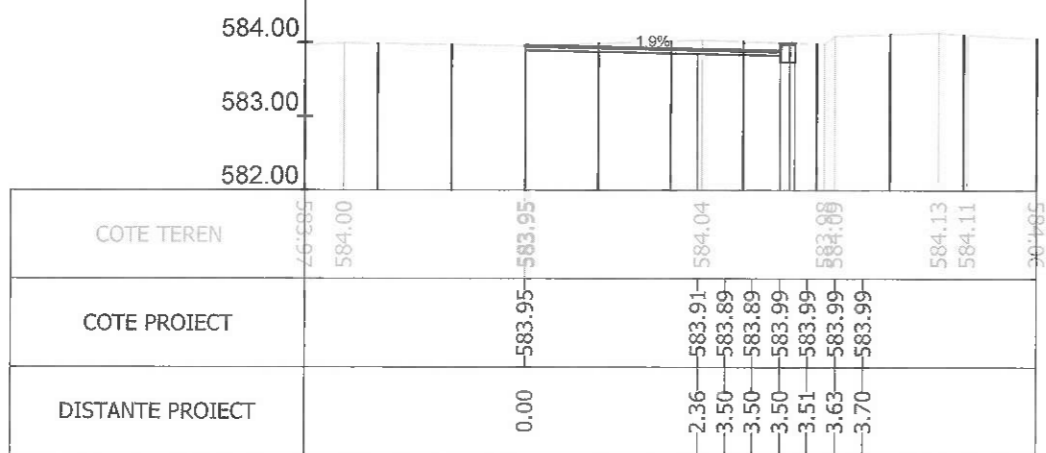

Sectiunea 120 - Km 1+659.844
Ax-Traseul 1

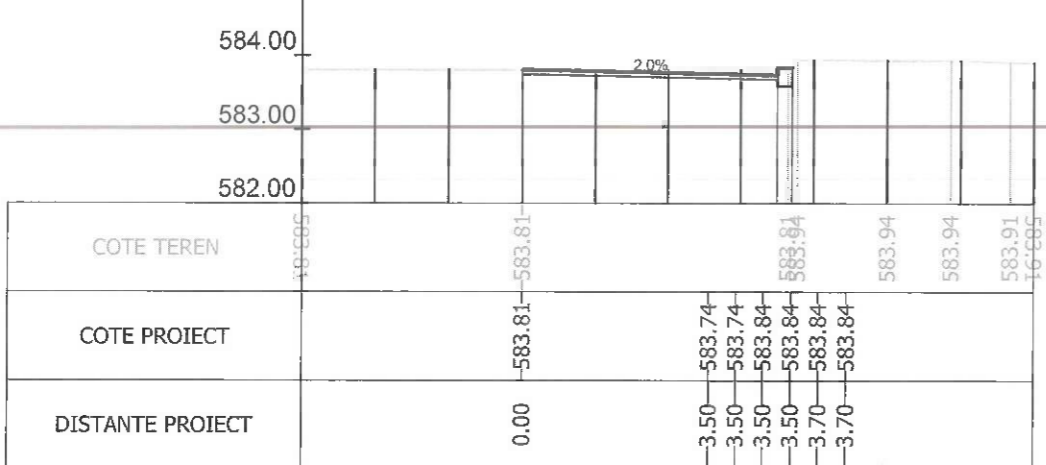

Sectiunea 122 - Km 1+676.146
Ax-Traseul 1

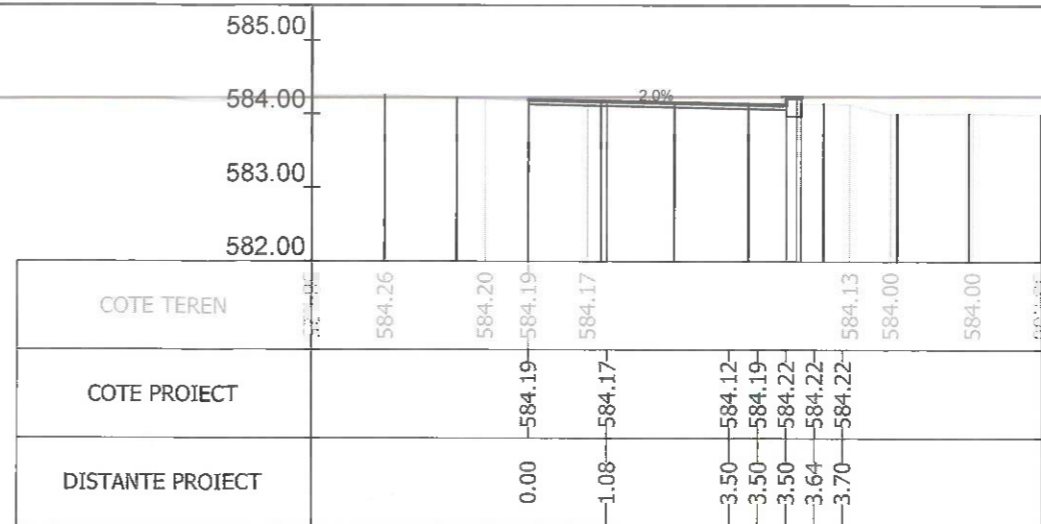

Sectiunea 119 - Km 1+650
Ax-Traseul 1

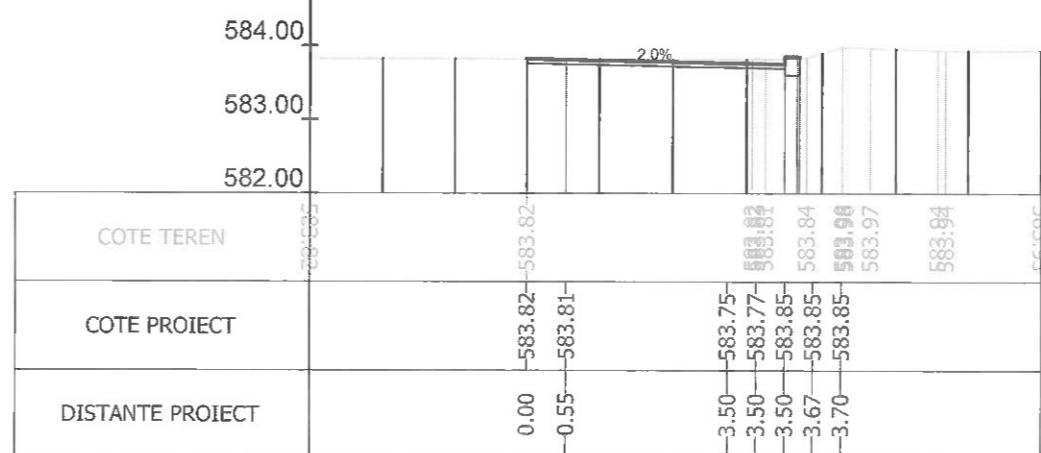

Sectiunea 121 - Km 1+675
Ax-Traseul 1

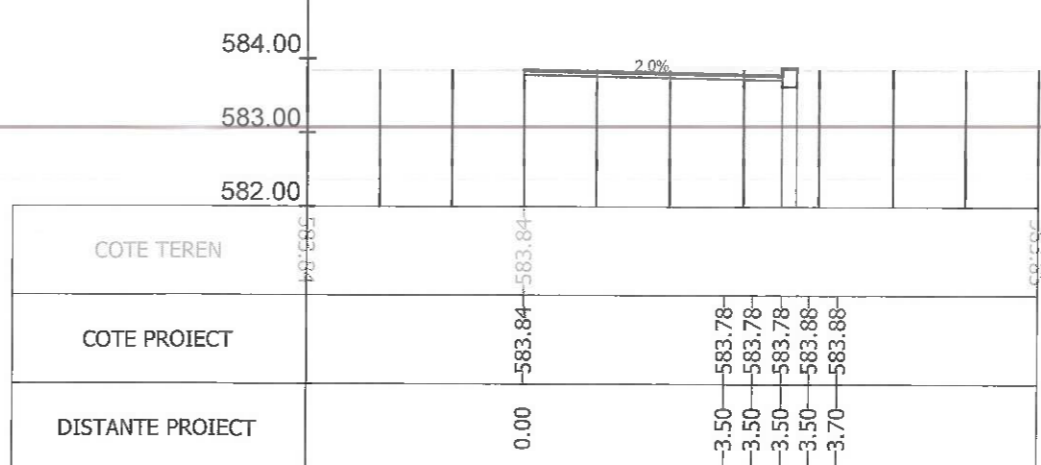

Sectiunea 123 - Km 1+697.595
Ax-Traseul 1

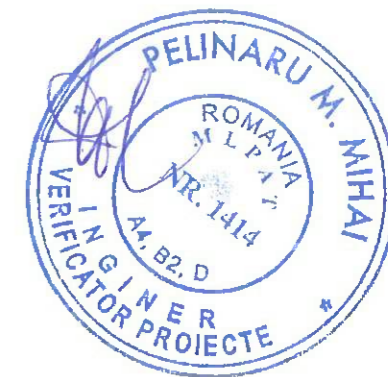

Index	Data	Observatii	Rev. 5
A			
		Beneficiar:	MUNICIPIUL BRASOV Bulevardul Eroilor 8, Brasov 500007
		Nr. proiect	73 / 2020
Sef Proiect: Ing. A. Buta Proiectat: Ing. A. Buta Desenat: Ing. S. Patroi Verificat:		Titlu proiect:	AMENAJARE BENZI DEDICATE TRANSPORTULUI PUBLIC IN MUNICIPIUL BRASOV SI TROTUARE ADIACENTE
Scara: 1/100		Faza:	P.T.
Data: 07/2023		Titlu plansa:	PROFILE TRANSVERSALE CURENTE
		Nr. plansa:	PT-18

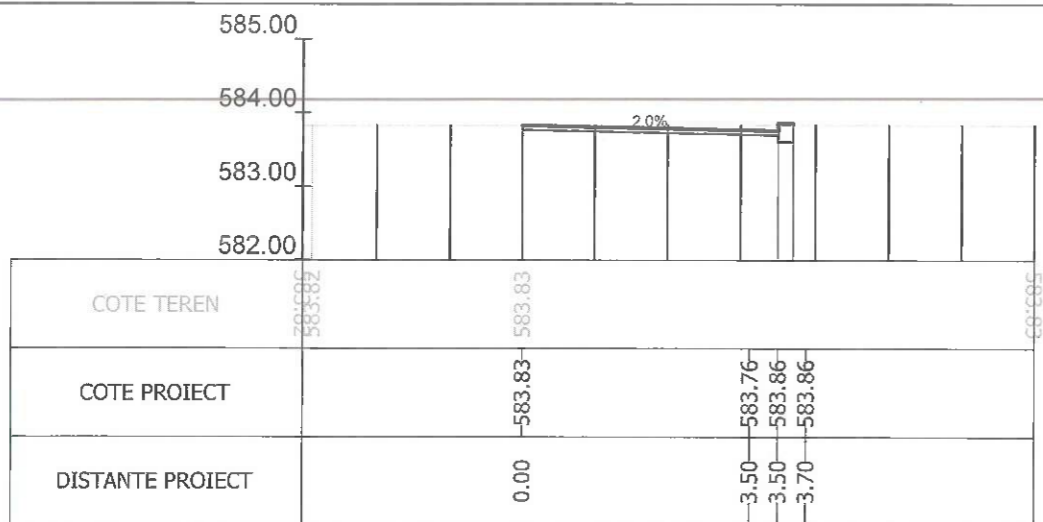

Sectiunea 124 - Km 1+700
Ax-Traseul 1

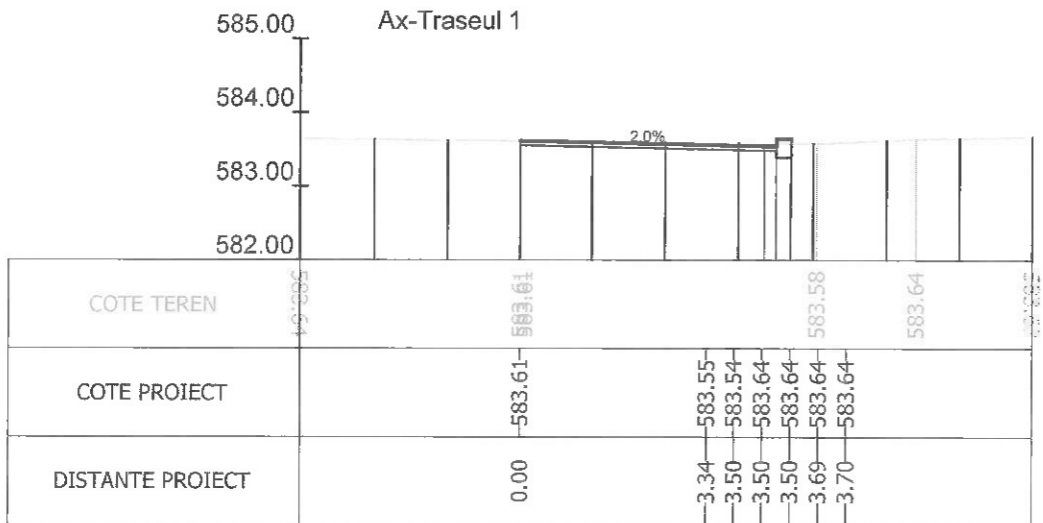

Sectiunea 126 - Km 1+727.772
Ax-Traseul 1

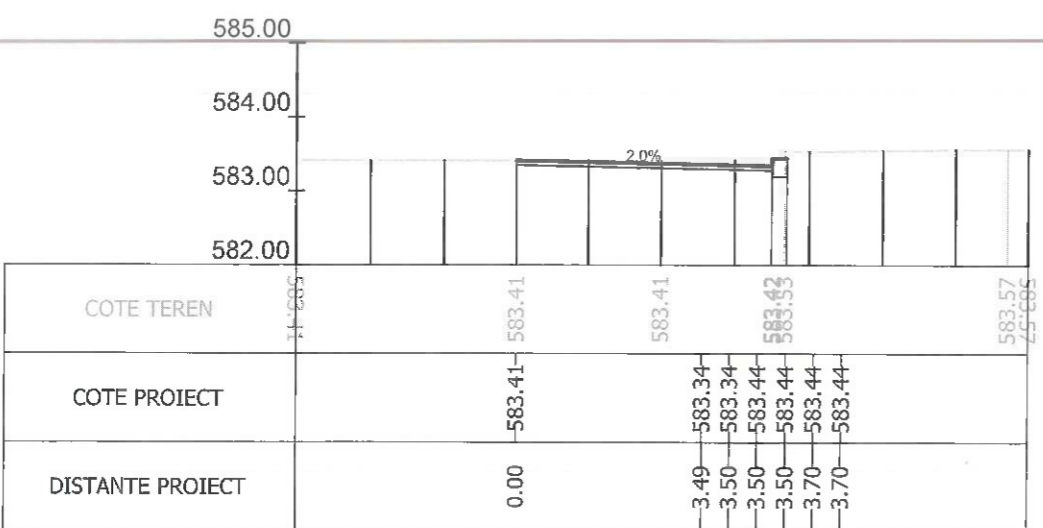

Sectiunea 128 - Km 1+757.899
Ax-Traseul 1

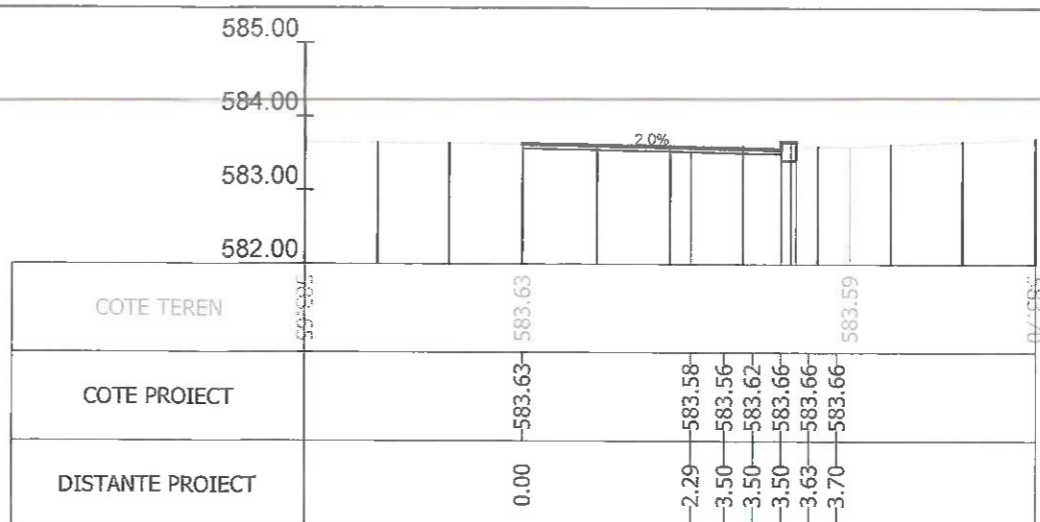

Sectiunea 125 - Km 1+725
Ax-Traseul 1

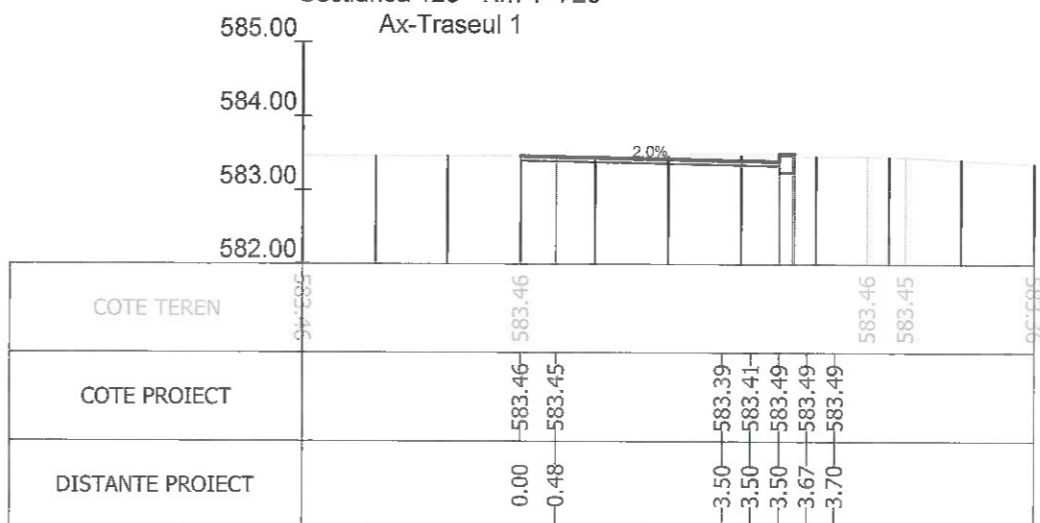

Sectiunea 127 - Km 1+750
Ax-Traseul 1

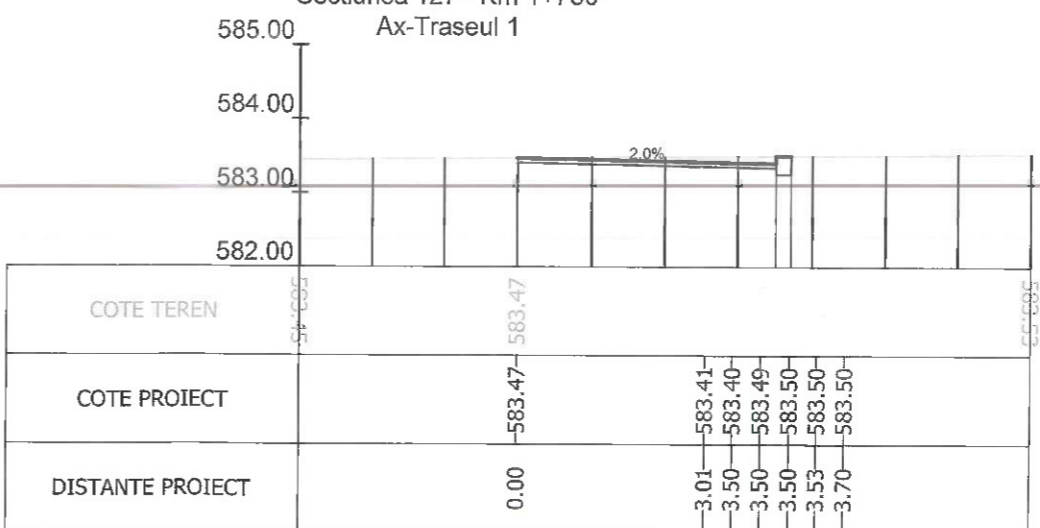

Sectiunea 129 - Km 1+775
Ax-Traseul 1



Index	Data	Observatii	Rev. 5
A			
		Beneficiar: MUNICIPIUL BRASOV Bulevardul Eroilor 8, Brasov 500007	
Sef Proiect Ing. A. Buta Proiectat Ing. A. Buta Desenat Ing. S. Patroi Verificat		Scara 1/100 Data 07/2023	Nr. proiect 73 / 2020 Faza P.T. Nr. planșa PT-19
		Titlu proiect: AMENAJARE BENZI DEDICATE TRANSPORTULUI PUBLIC IN MUNICIPIUL BRASOV SI TROTUARE ADIACENTE Titlu planșa: PROFILE TRANSVERSALE CURENTE	

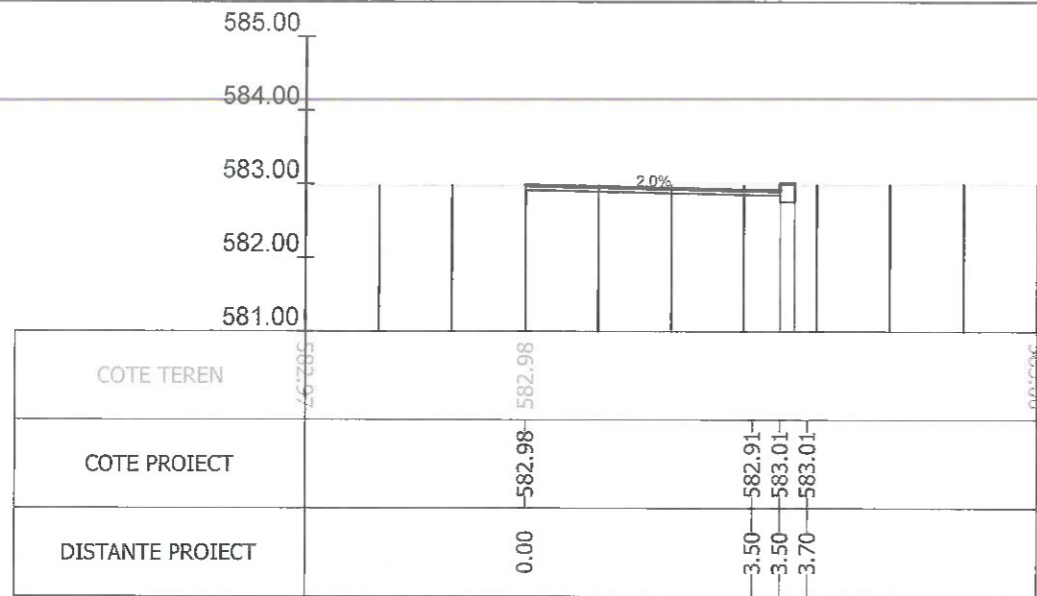

Sectiunea 130 - Km 1+800
Ax-Traseul 1

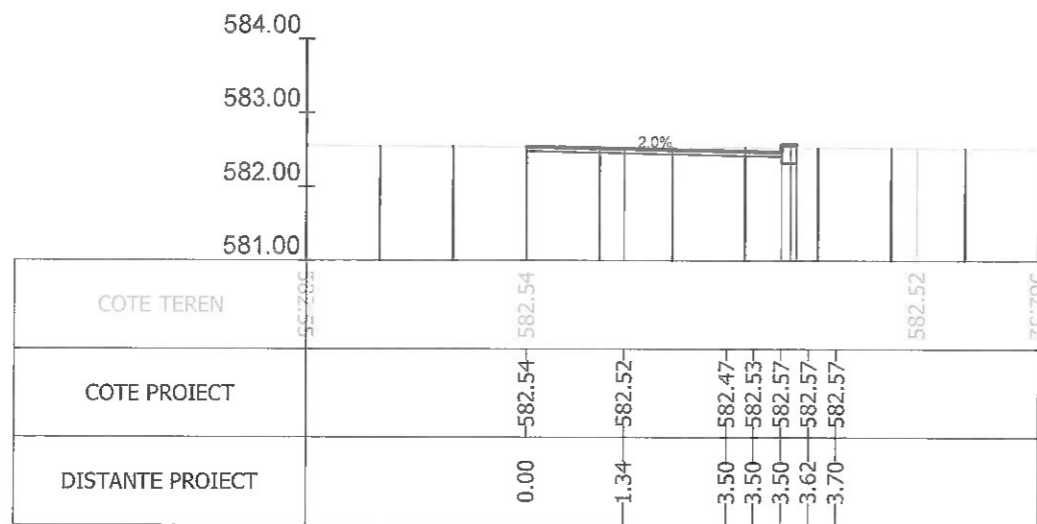

Sectiunea 132 - Km 1+825
Ax-Traseul 1

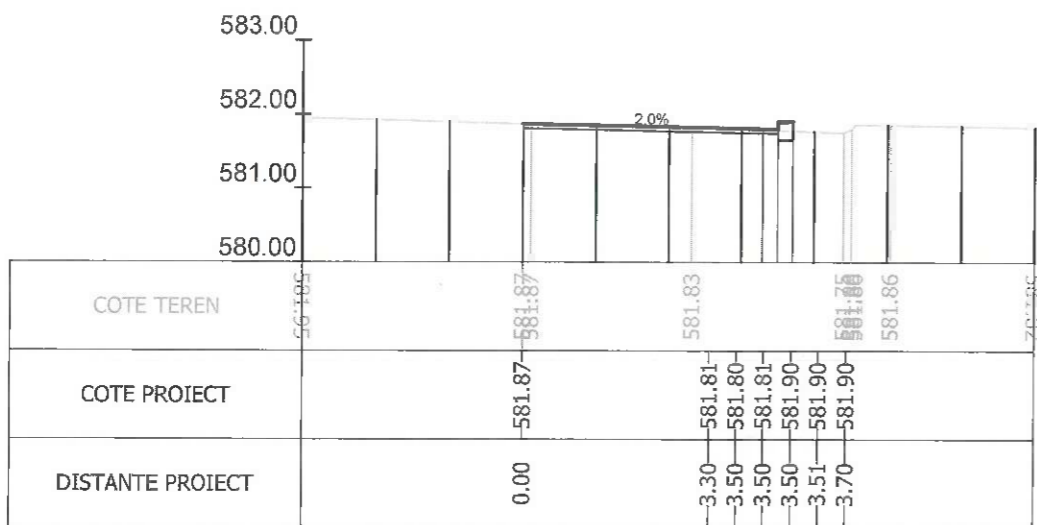

Sectiunea 134 - Km 1+850
Ax-Traseul 1

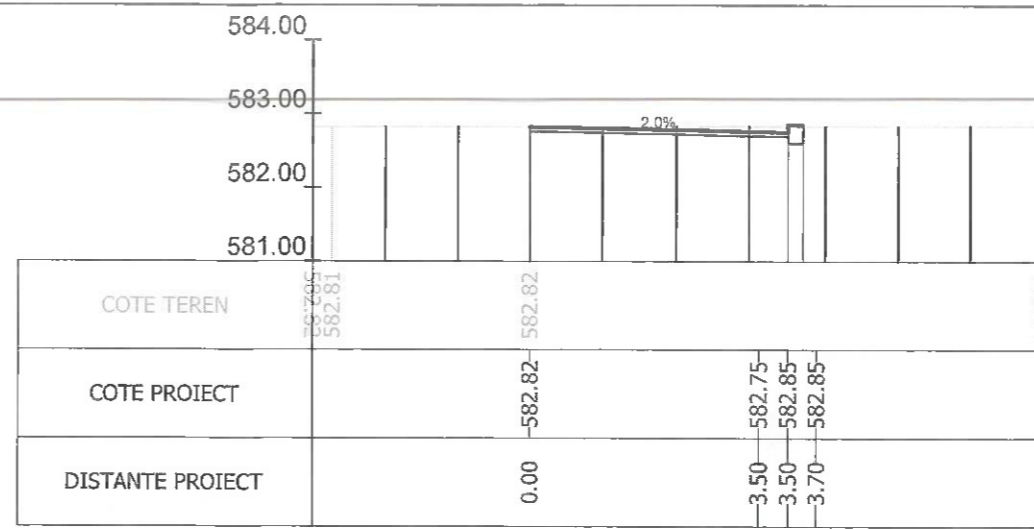

Sectiunea 131 - Km 1+805.998
Ax-Traseul 1

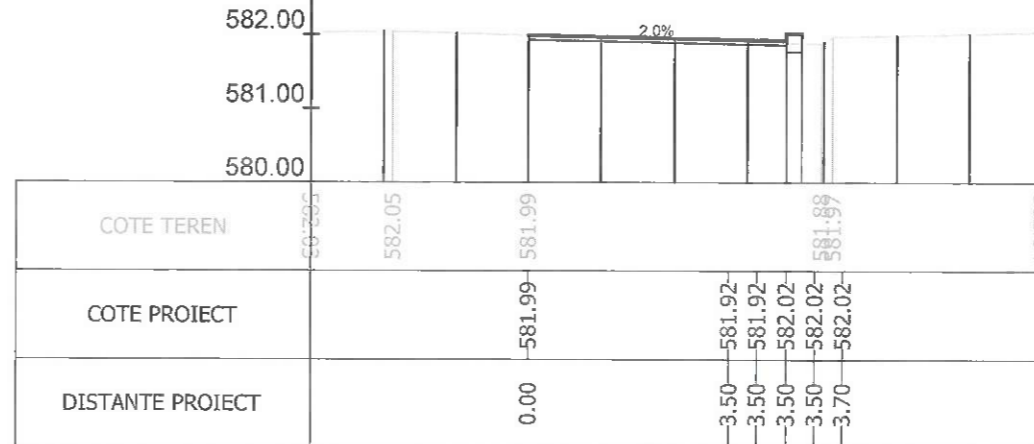

Sectiunea 133 - Km 1+845.988
Ax-Traseul 1

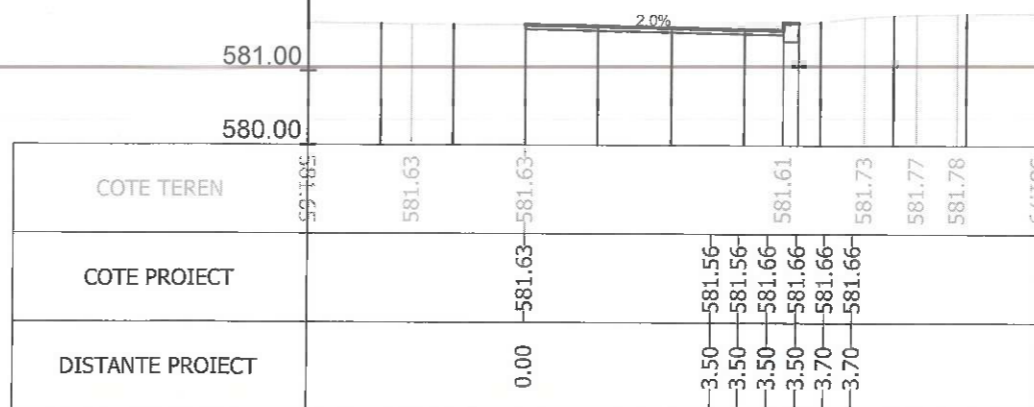

Sectiunea 135 - Km 1+863.140
Ax-Traseul 1



Index	Data Observatii	Rev. 5
A		
		Beneficiar: MUNICIPIUL BRASOV Bulevardul Eroilor 8, Brasov 500007
Sef Proiect: Ing. A. Buta Proiectat: Ing. A. Buta Desenat: Ing. S. Patroi Verificat:		Nr. proiect 73 / 2020
Scara: 1/100 Data: 07/2023		Faza P.T.
Titlu proiect: AMENAJARE BENZI DEDICATE TRANSPORTULUI PUBLIC IN MUNICIPIUL BRASOV SI TROTUARE ADIACENTE		Nr. plansa PT-20
Titlu plansa: PROFILE TRANSVERSALE CURENTE		

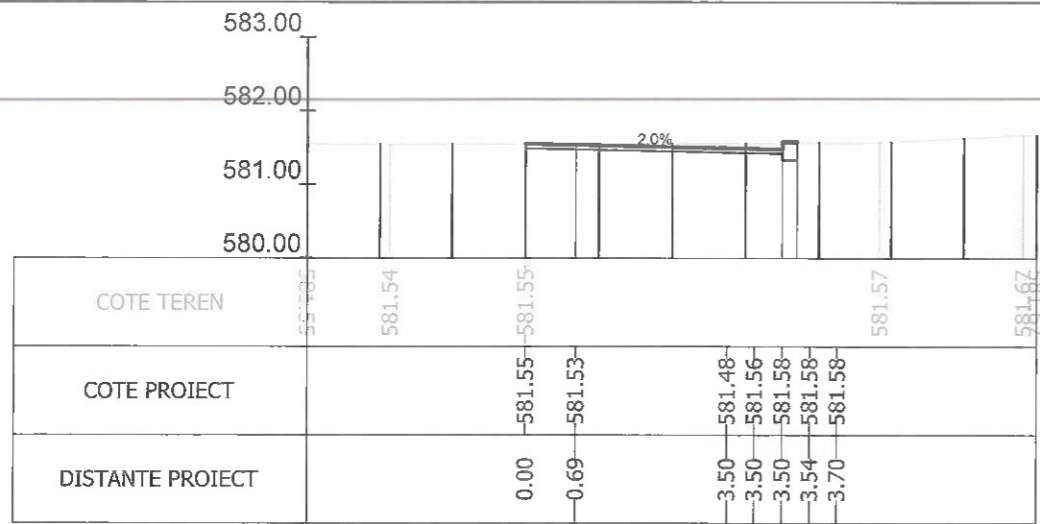

Sectiunea 136 - Km 1+875
Ax-Traseul 1

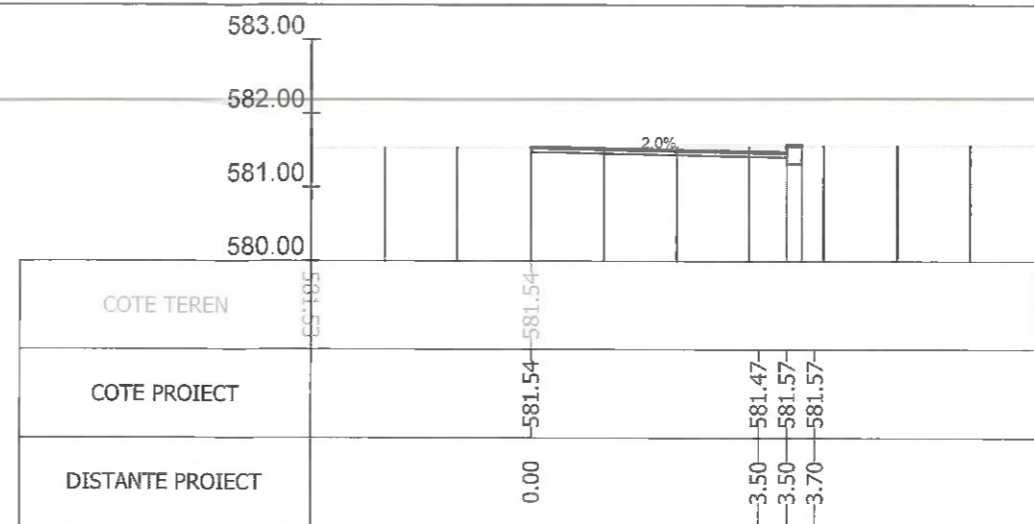

Sectiunea 137 - Km 1+888.153
Ax-Traseul 1

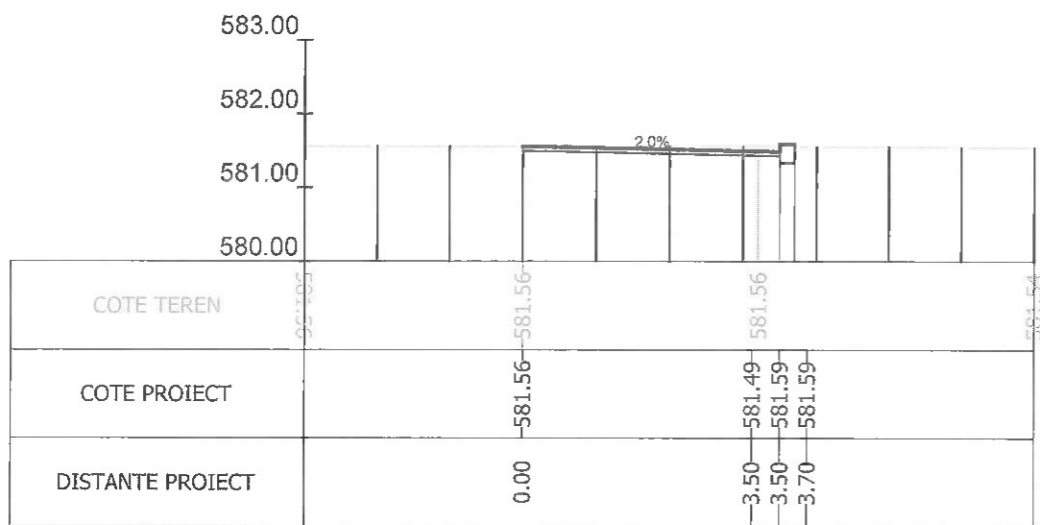

Sectiunea 138 - Km 1+900
Ax-Traseul 1

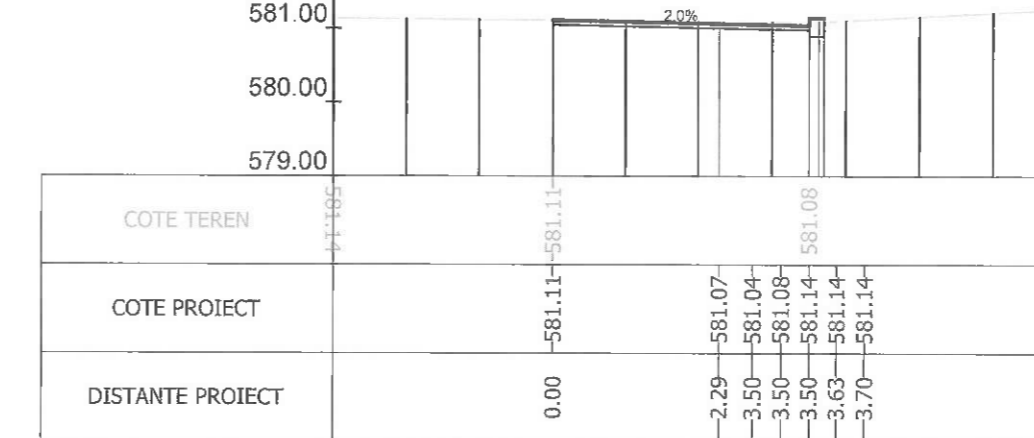

Sectiunea 139 - Km 1+925
Ax-Traseul 1

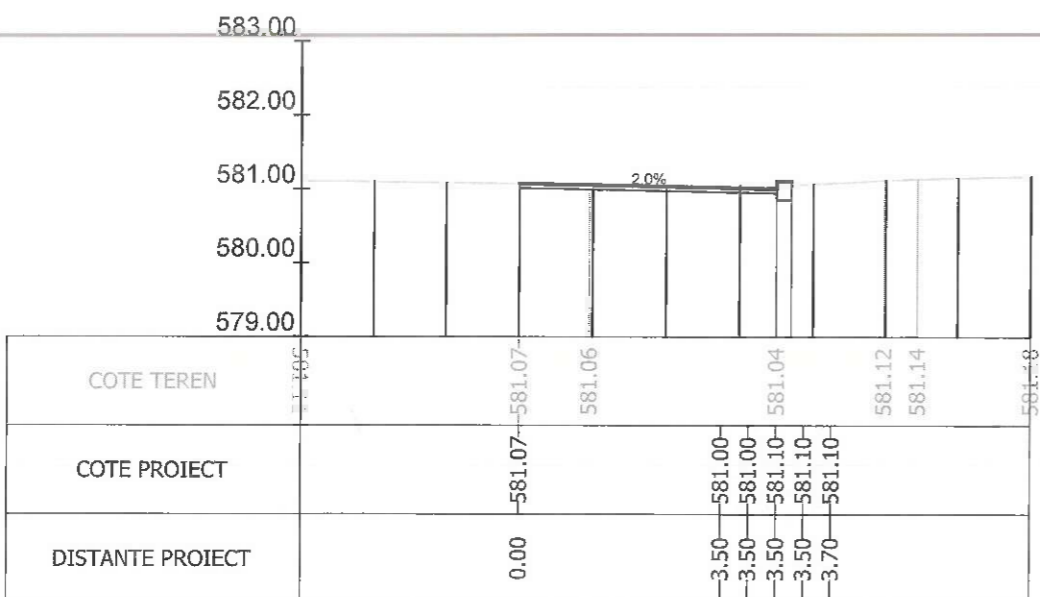

Sectiunea 140 - Km 1+928.170
Ax-Traseul 1

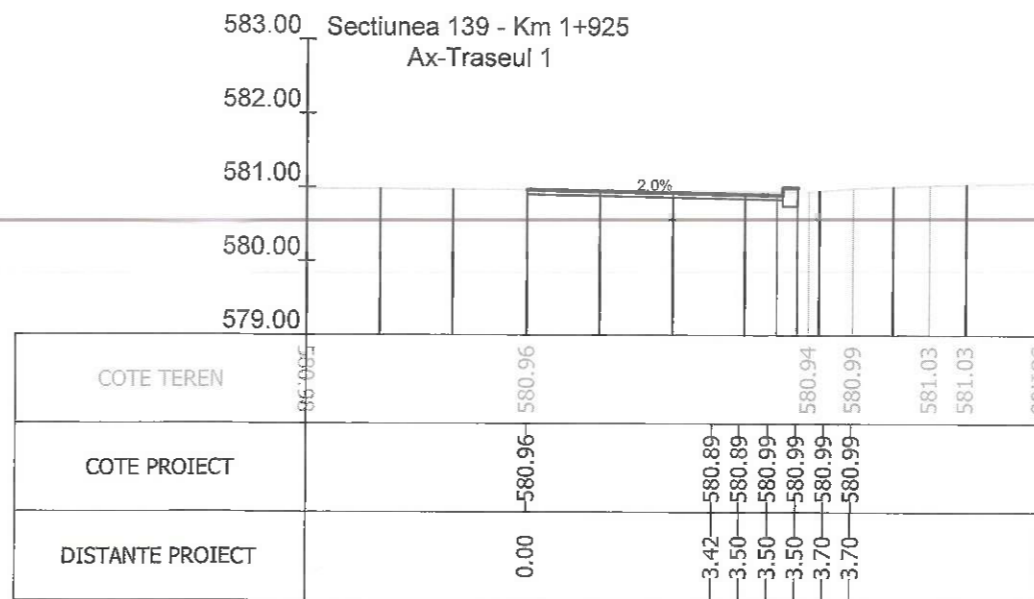

Sectiunea 141 - Km 1+943.406
Ax-Traseul 1



Index A	Data 07/2023	Observatii Sectiunea 141 - Km 1+943.406 Ax-Traseul 1	Rev. 5
 www.hentza.ro SOCIETATEA CU CAPITAL ROMAN, S.R.L.		Beneficiar: MUNICIPIUL BRASOV Bulevardul Eroilor 8, Brasov 500007	Nr. proiect 73 / 2020
Sef Proiect: Ing. A. Buta Proiectat: Ing. A. Buta Desenat: Ing. S. Patroi Verificat:		Titlu proiect: AMENAJARE BENZI DEDICATE TRANSPORTULUI PUBLIC IN MUNICIPIUL BRASOV SI TROTUARE ADIACENTE	Faza P.T.
Scara 1/100 Data 07/2023		Titlu plansa: PROFILE TRANSVERSALE CURENTE	Nr. plansa PT-21

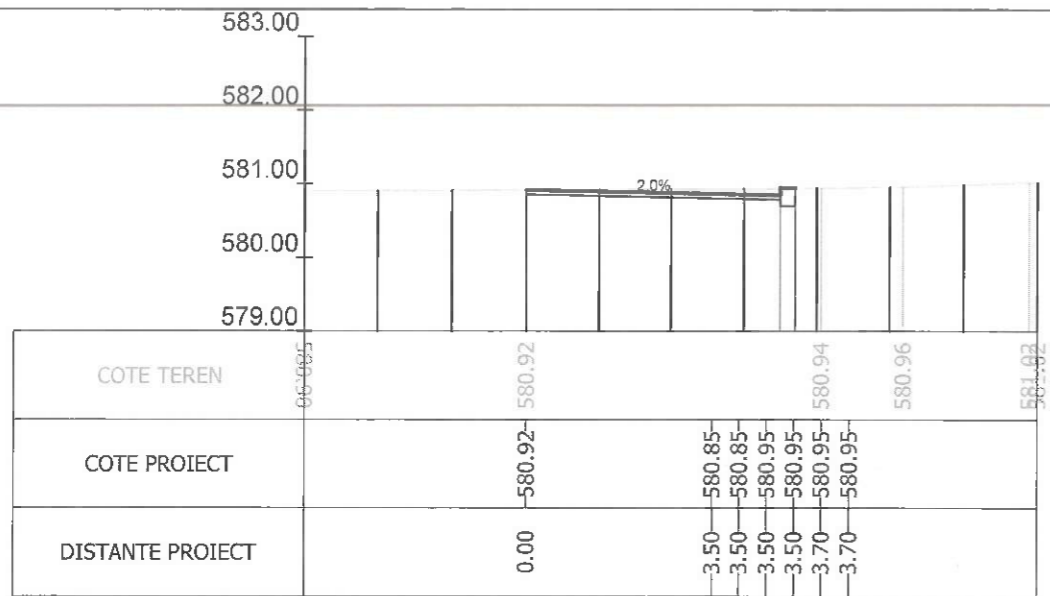

Sectiunea 142 - Km 1+948.400
Ax-Traseul 1

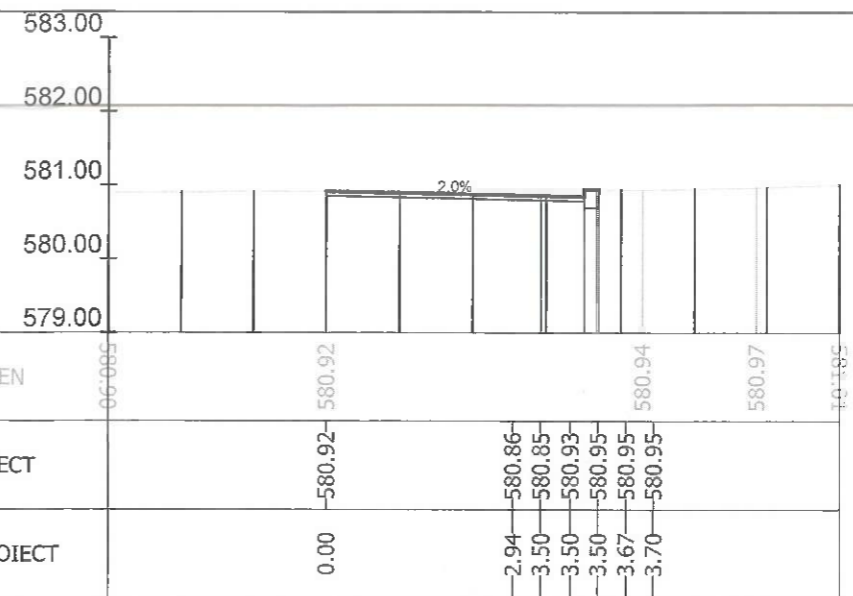
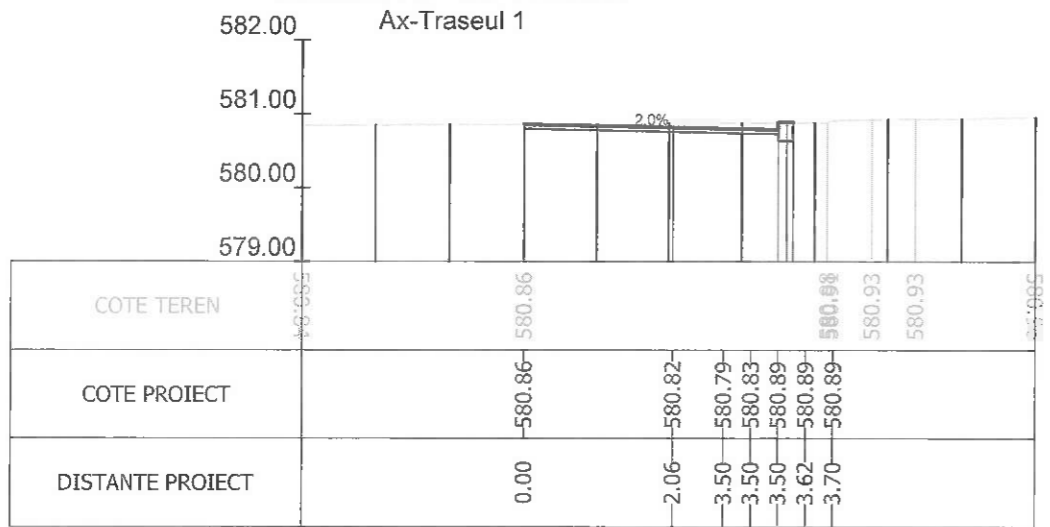

Sectiunea 143 - Km 1+950
Ax-Traseul 1

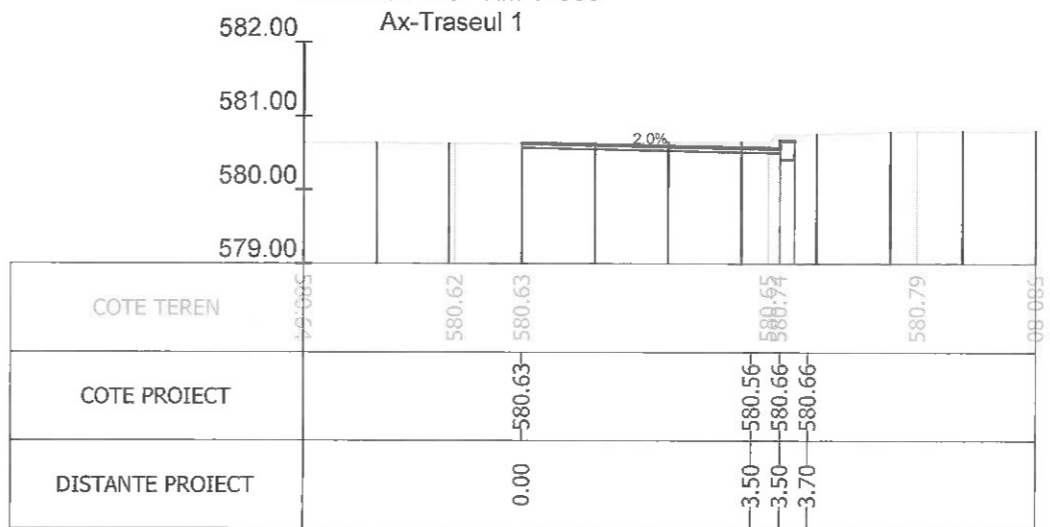

Sectiunea 145 - Km 1+982.925
Ax-Traseul 1

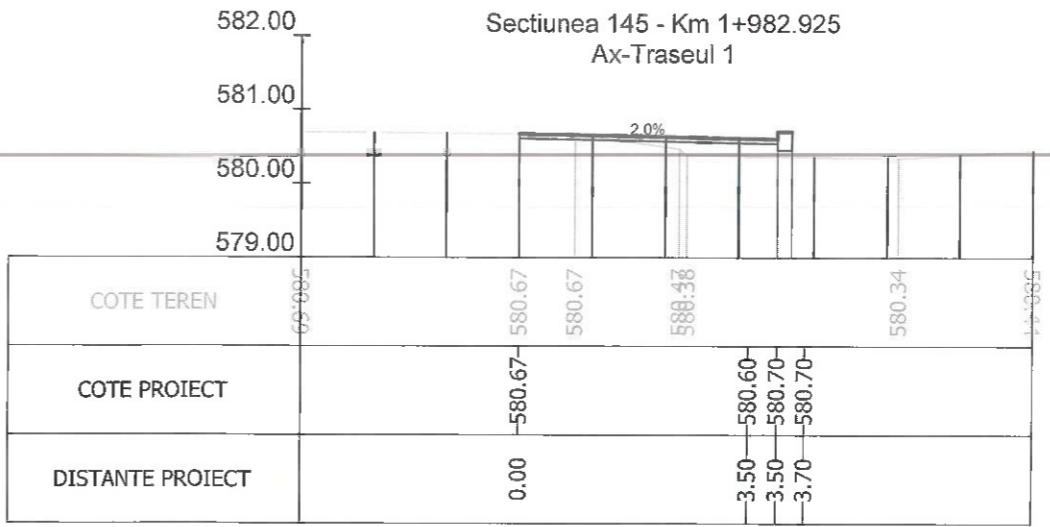

Sectiunea 146 - Km 2+000
Ax-Traseul 1

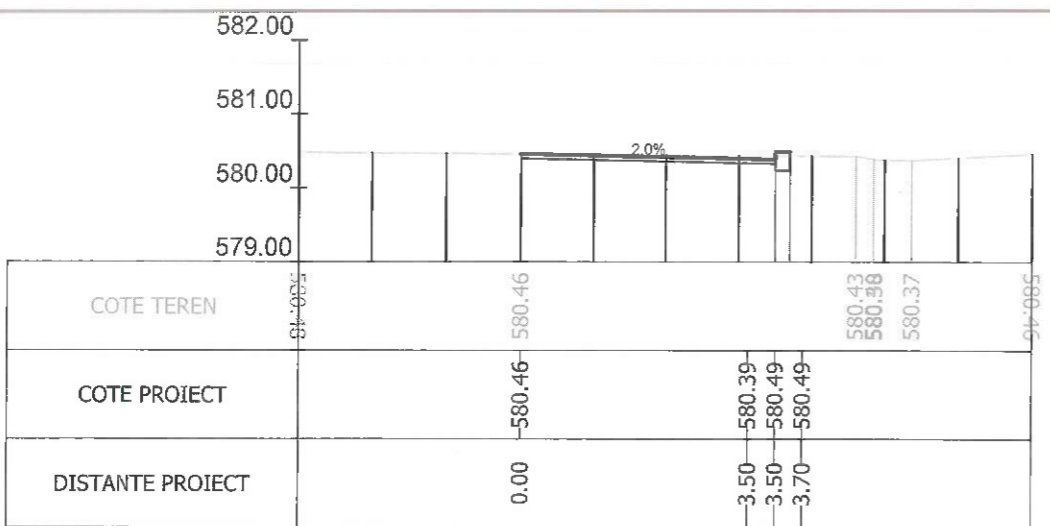

Sectiunea 147 - Km 2+002.578
Ax-Traseul 1

HENTZA BUSINESS
www.hentza.ro

SEF PROIECT: Ing. A. Buta
PROIECTAT: Ing. A. Buta
DESENAT: Ing. S. Patroi
VERIFICAT: [Signature]

Scara: 1/100
Data: 07/2023

Beneficiar:	MUNICIPIUL BRASOV Bulevardul Eroilor 8, Brasov 500007	Nr. proiect	73 / 2020
Titlu proiect:	AMENAJARE BENZI DEDICATE TRANSPORTULUI PUBLIC IN MUNICIPIUL BRASOV SI TROTUARE ADIACENTE	Faza	P.T.
Titlu plansa:	PROFILE TRANSVERSALE CURENTE	Nr. plansa	PT-22



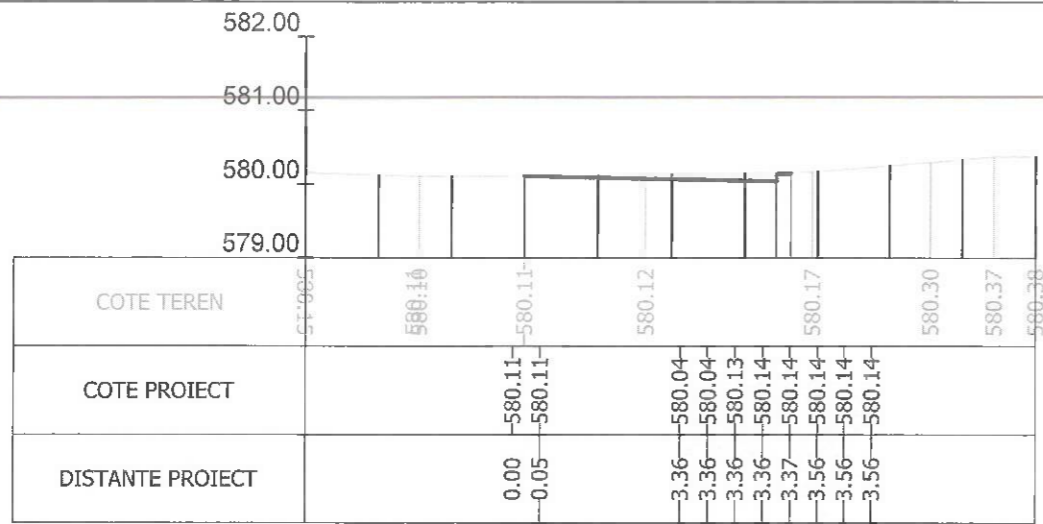

Sectiunea 148 - Km 2+022.230
Ax-Traseul 1

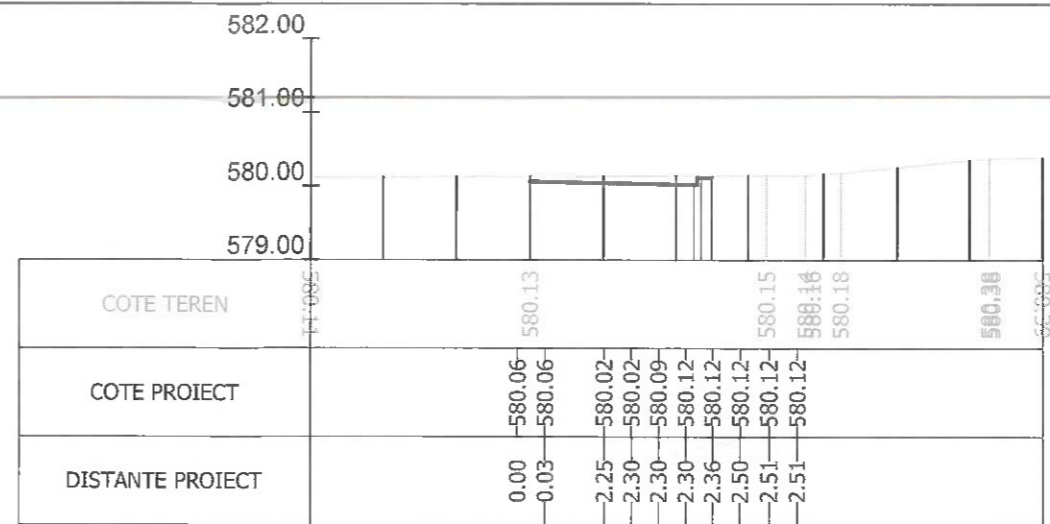
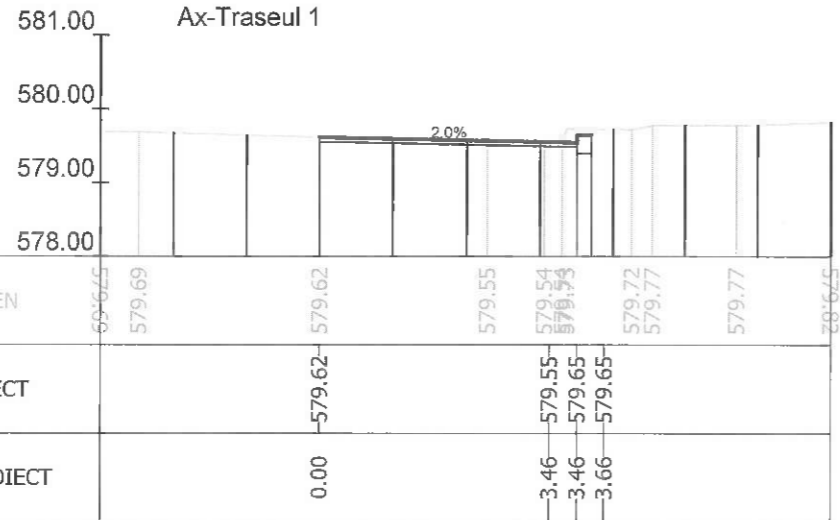

Sectiunea 149 - Km 2+025
Ax-Traseul 1

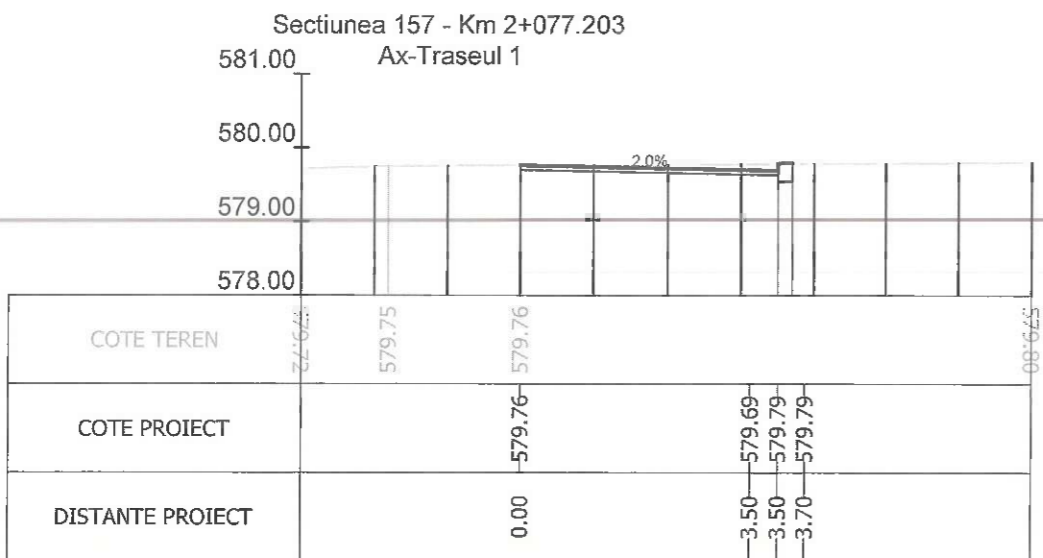
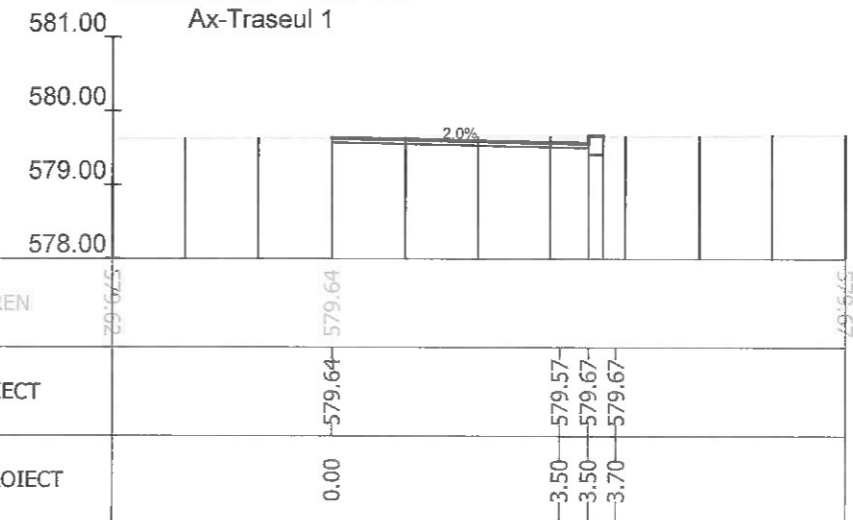

Sectiunea 157 - Km 2+077.203
Ax-Traseul 1

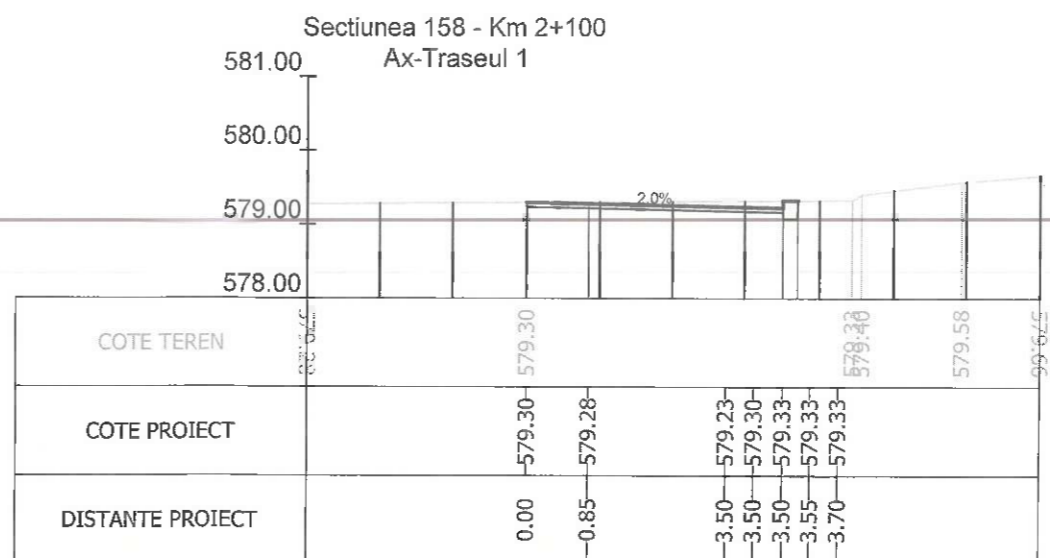
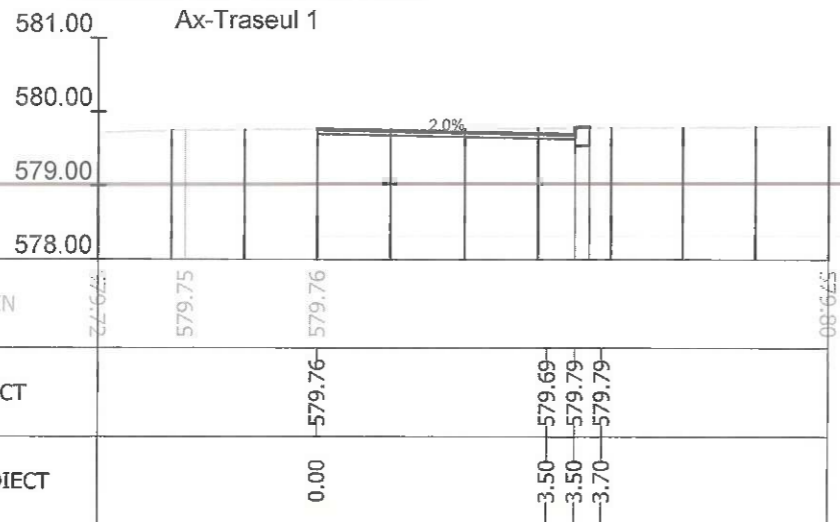

Sectiunea 158 - Km 2+100
Ax-Traseul 1

Sectiunea 159 - Km 2+111.013
Ax-Traseul 1

Sectiunea 160 - Km 2+125
Ax-Traseul 1



Index	Data	Observatii	Rev. 5
A			
		Beneficiar:	MUNICIPIUL BRASOV Bulevardul Eroilor 8, Brasov 500007
Sef Proiect: Ing. A. Buta Proiectat: Ing. A. Buta Desenat: Ing. S. Patroi Verificat:		Nr. proiect	73 / 2020
Scara: 1/100 Data: 07/2023		Titlu proiect:	AMENAJARE BENZI DEDICATE TRANSPORTULUI PUBLIC IN MUNICIPIUL BRASOV SI TROTUARE ADIACENTE
		Titlu plansa:	PROFILE TRANSVERSALE CURENTE
		Faza	P.T.
		Nr. plansa	PT-23

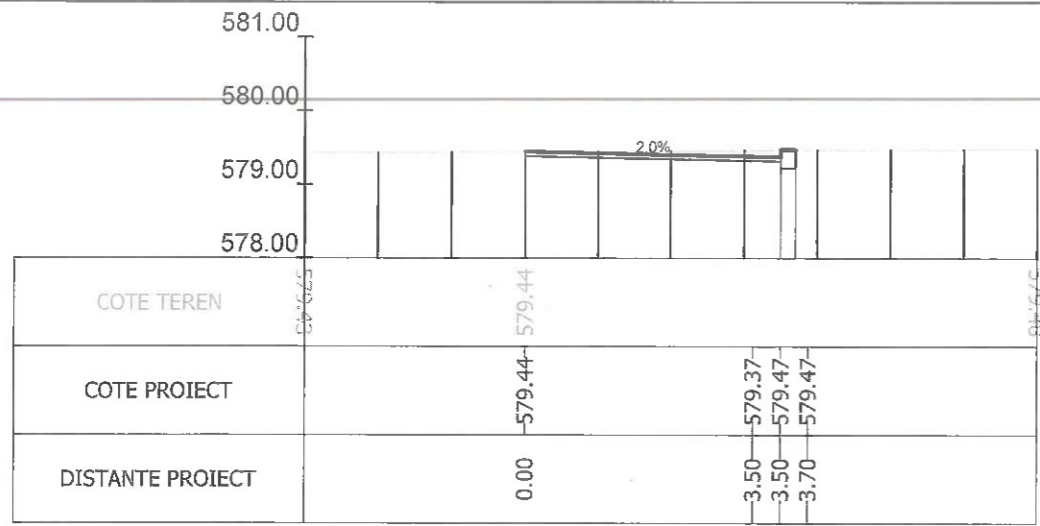

Sectiunea 161 - Km 2+144.823
Ax-Traseul 1

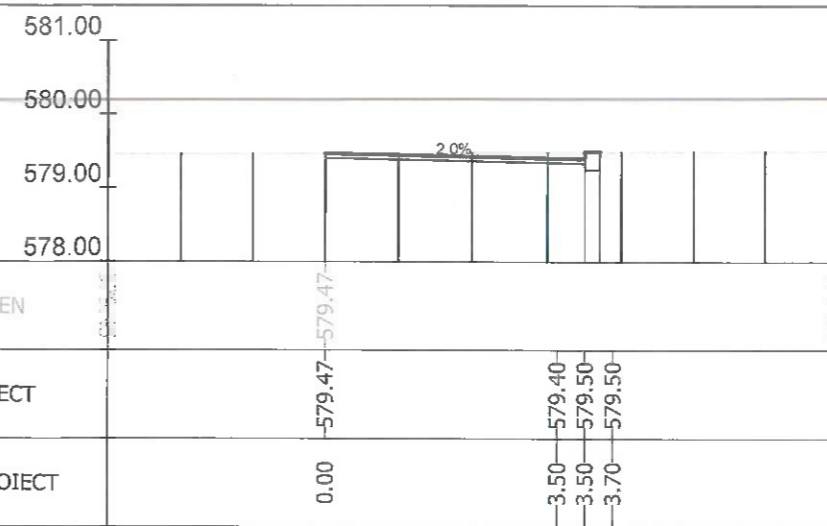
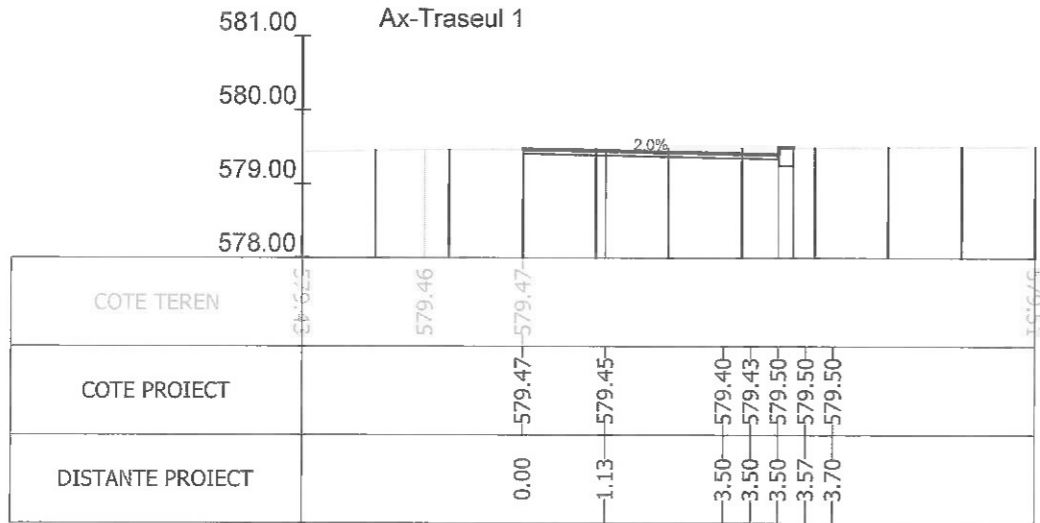

Sectiunea 162 - Km 2+148.823
Ax-Traseul 1

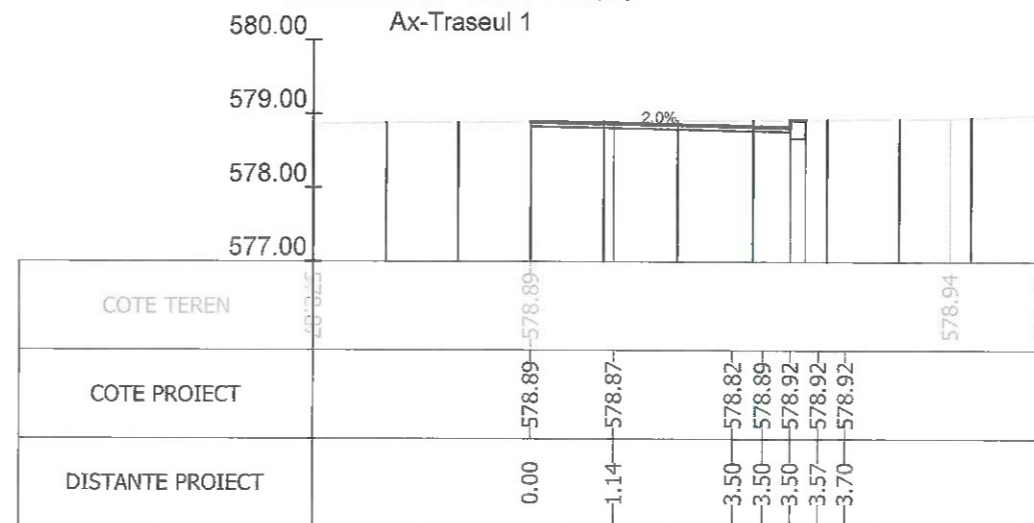

Sectiunea 163 - Km 2+150
Ax-Traseul 1

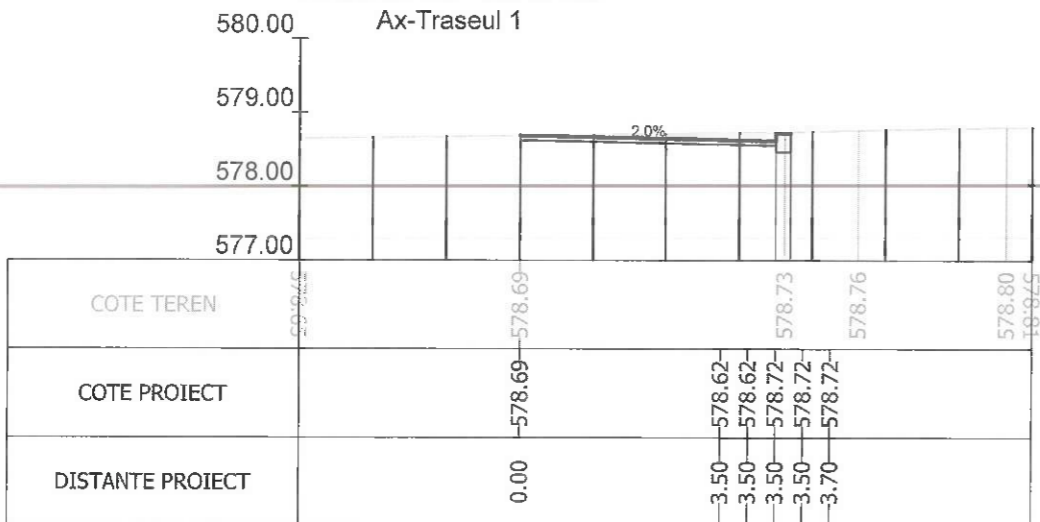

Sectiunea 164 - Km 2+175
Ax-Traseul 1

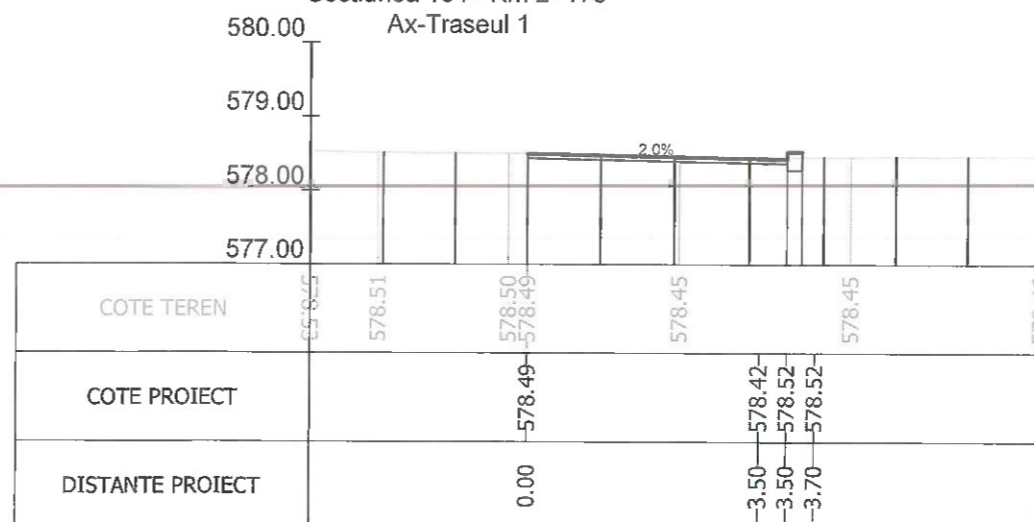

Sectiunea 165 - Km 2+185.455
Ax-Traseul 1

Sectiunea 166 - Km 2+200
Ax-Traseul 1

Index	Data	Observatii	Rev. 5
A			
		Beneficiar:	MUNICIPIUL BRASOV Bulevardul Eroilor 8, Brasov 500007
Sef Proiect	Ing. A. Buta	Titlu proiect:	AMENAJARE BENZI DEDICATE TRANSPORTULUI PUBLIC IN MUNICIPIUL BRASOV SI TROTUARE ADIACENTE
Proiectat	Ing. A. Buta	Titlu plansa:	PROFILE TRANSVERSALE CURENTE
Desenat	Ing. S. Patroi	Nr. proiect	73 / 2020
Verificat		Faza	P.T.
		Nr. plansa	PT-24
		Scara	1/100
		Data	07/2023



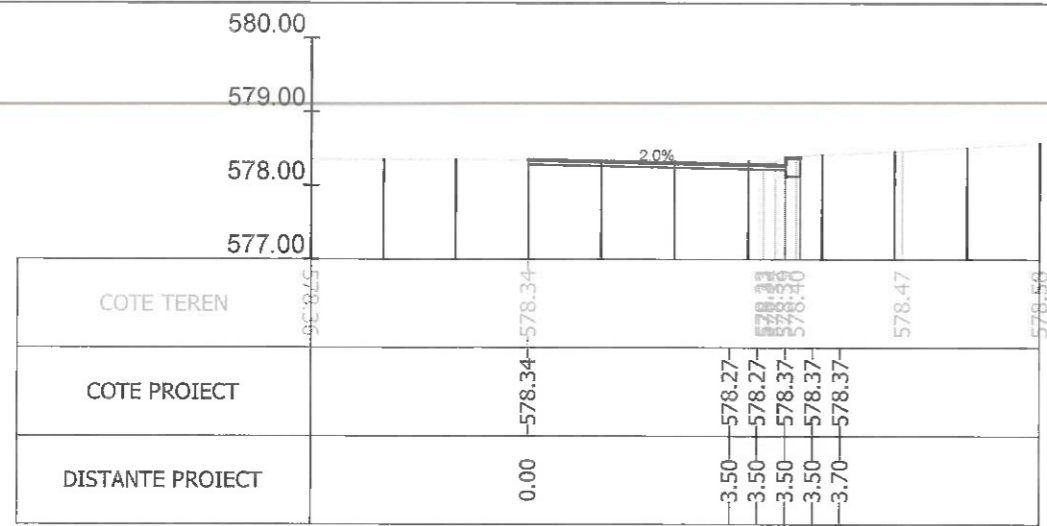

Sectiunea 167 - Km 2+213.762
Ax-Traseul 1

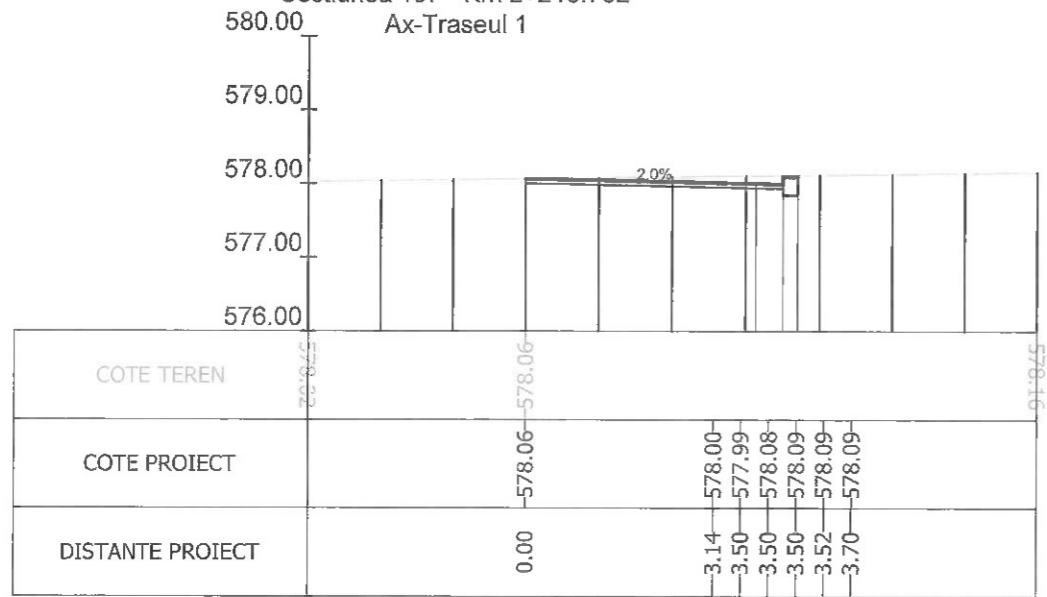

Sectiunea 169 - Km 2+250
Ax-Traseul 1

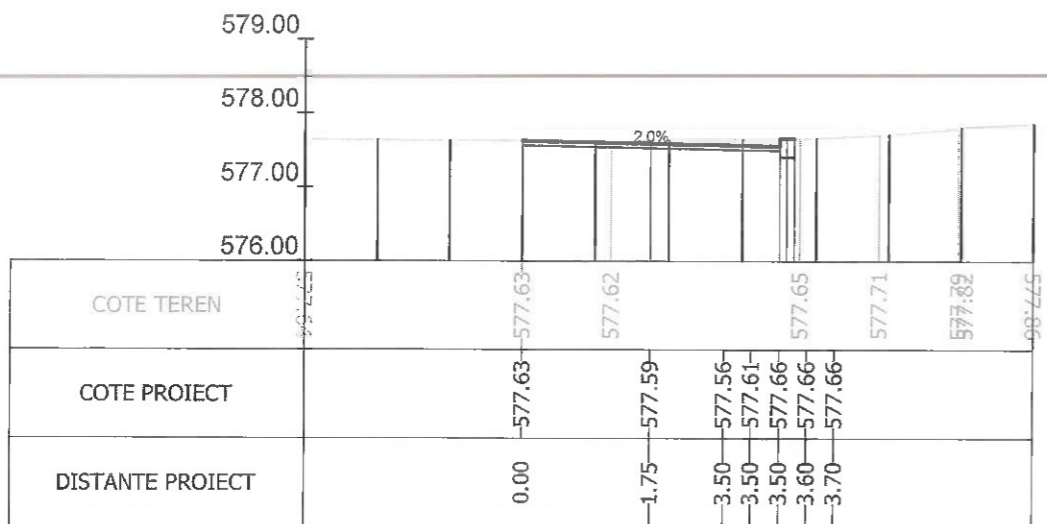

Sectiunea 171 - Km 2+275
Ax-Traseul 1

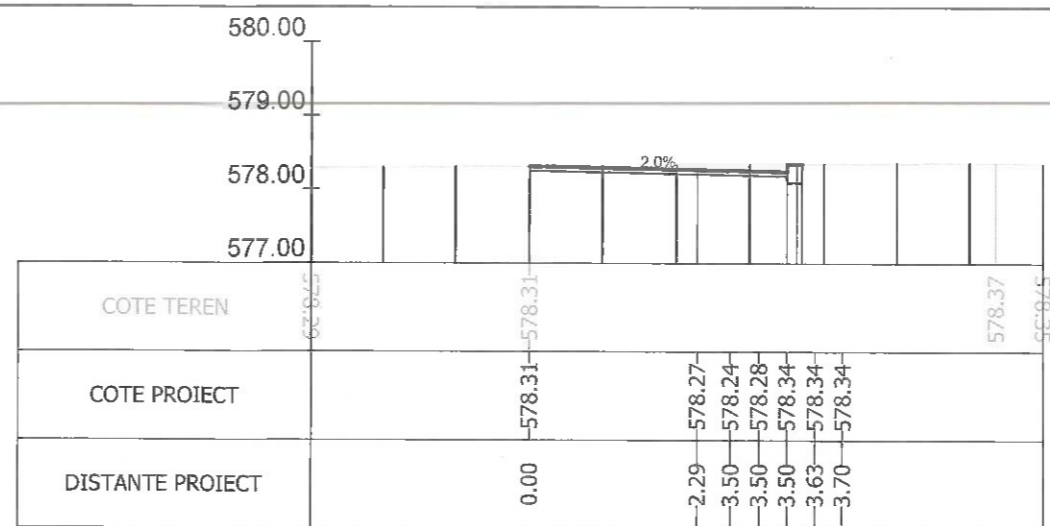

Sectiunea 168 - Km 2+225
Ax-Traseul 1

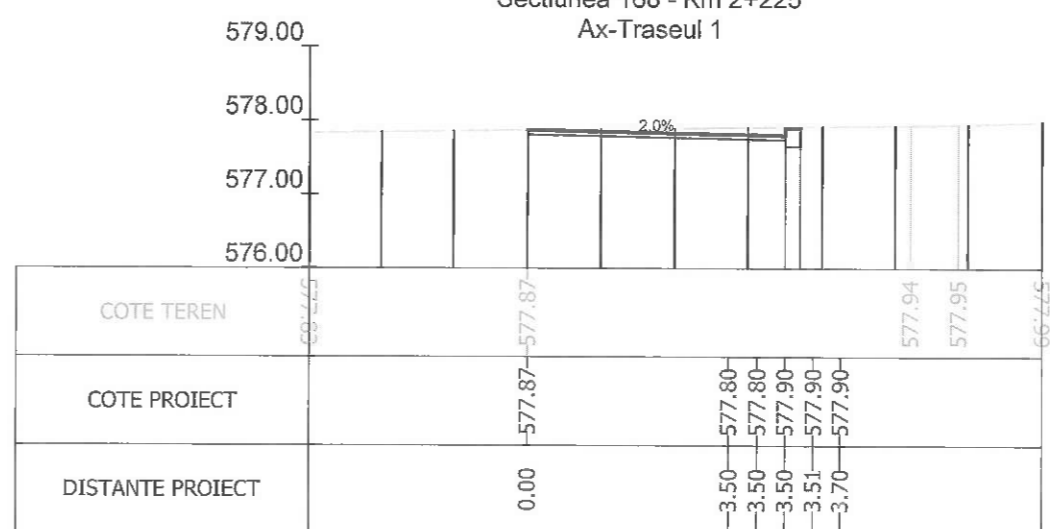

Sectiunea 170 - Km 2+260.630
Ax-Traseul 1

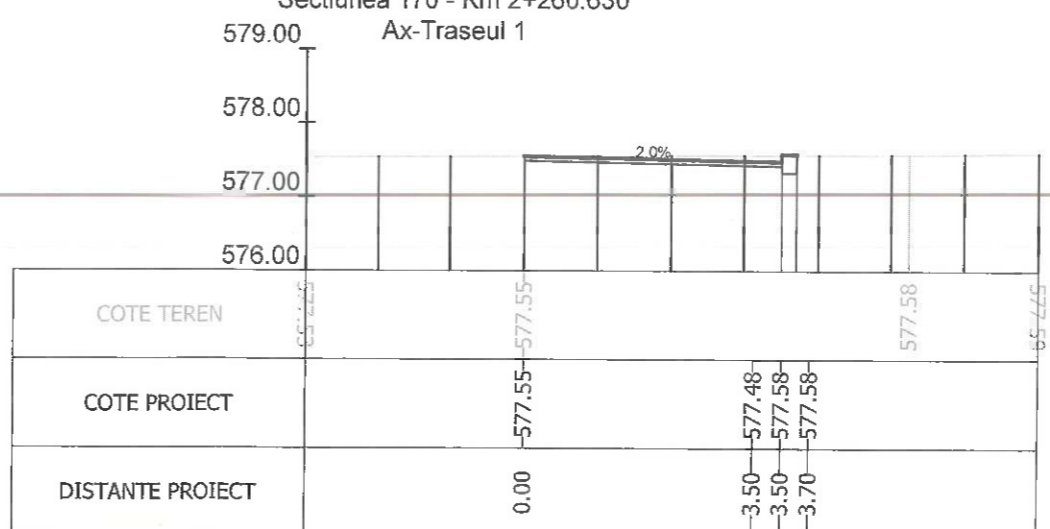

Sectiunea 172 - Km 2+300
Ax-Traseul 1

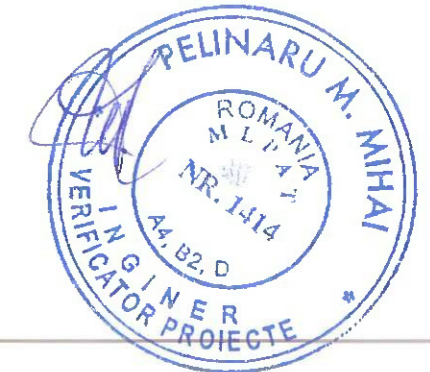

Index	A		Rev. 5
		Beneficiar:	MUNICIPIUL BRASOV Bulevardul Eroilor 8, Brasov 500007
Sef Proiect: Ing. A. Buta Proiectat: Ing. A. Buta Desenat: Ing. S. Patroi Verificat:		Nr. proiect	73 / 2020
Scara: 1/100 Data: 07/2023		Titlu proiect:	AMENAJARE BENZI DEDICATE TRANSPORTULUI PUBLIC IN MUNICIPIUL BRASOV SI TROTUARE ADIACENTE
		Titlu plansa:	PROFILE TRANSVERSALE CURENTE
		Faza	P.T.
		Nr. plansa	PT-25

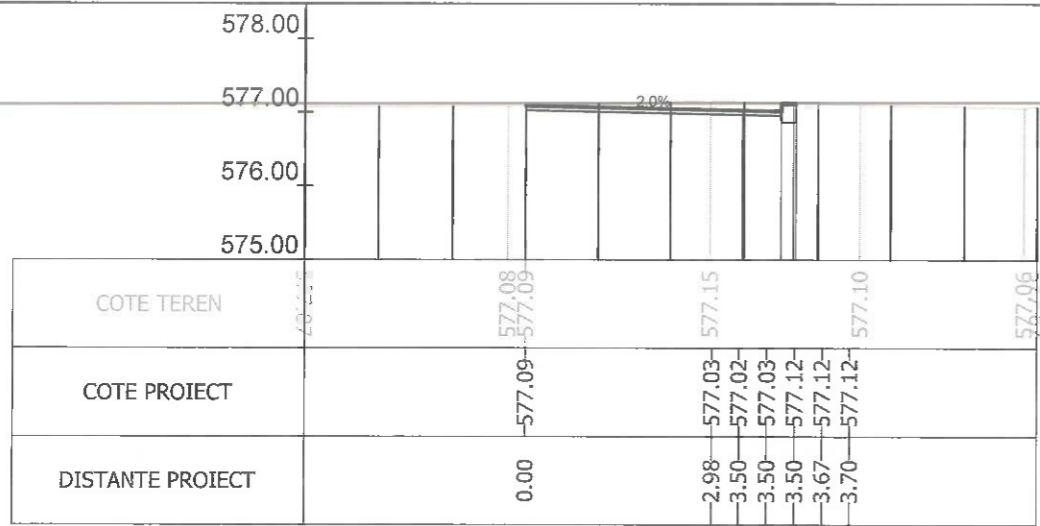

Sectiunea 173 - Km 2+325
Ax-Traseul 1

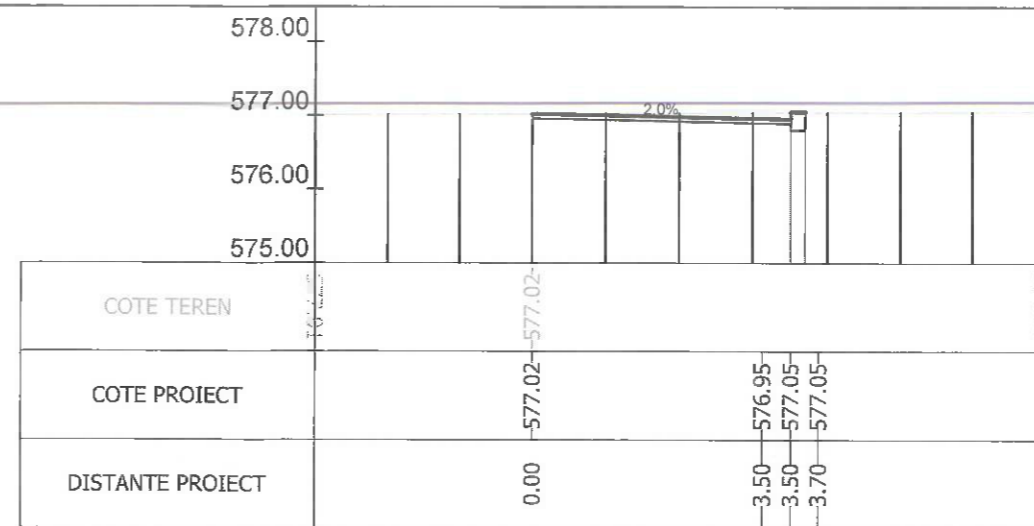

Sectiunea 174 - Km 2+335.246
Ax-Traseul 1

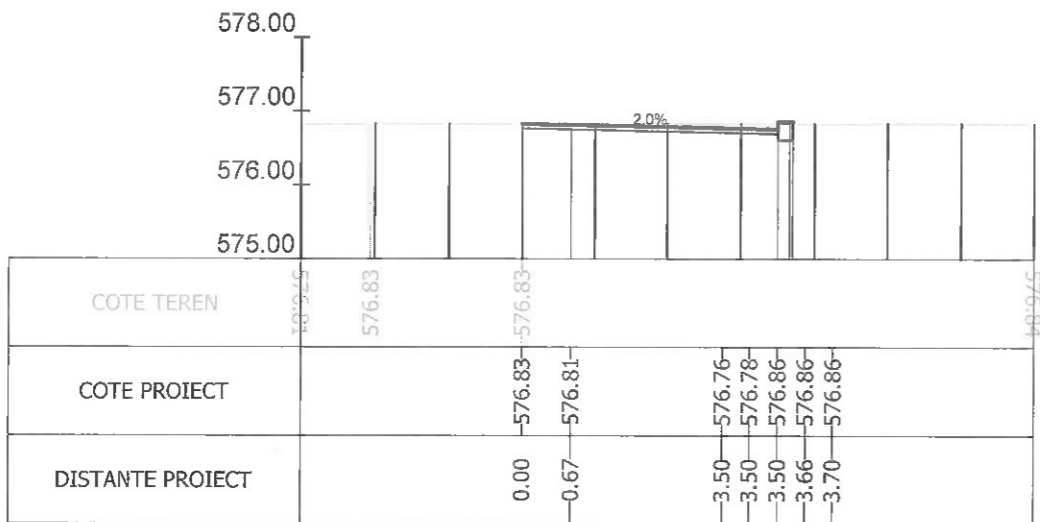

Sectiunea 175 - Km 2+350
Ax-Traseul 1

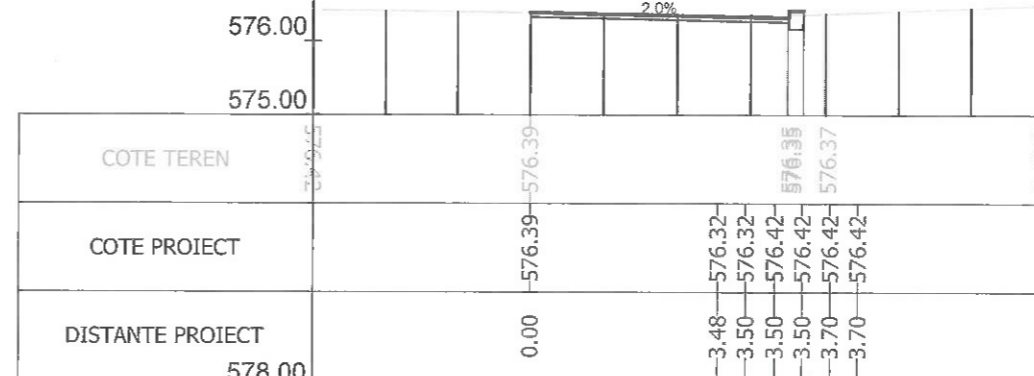

Sectiunea 176 - Km 2+374.997
Ax-Traseul 1

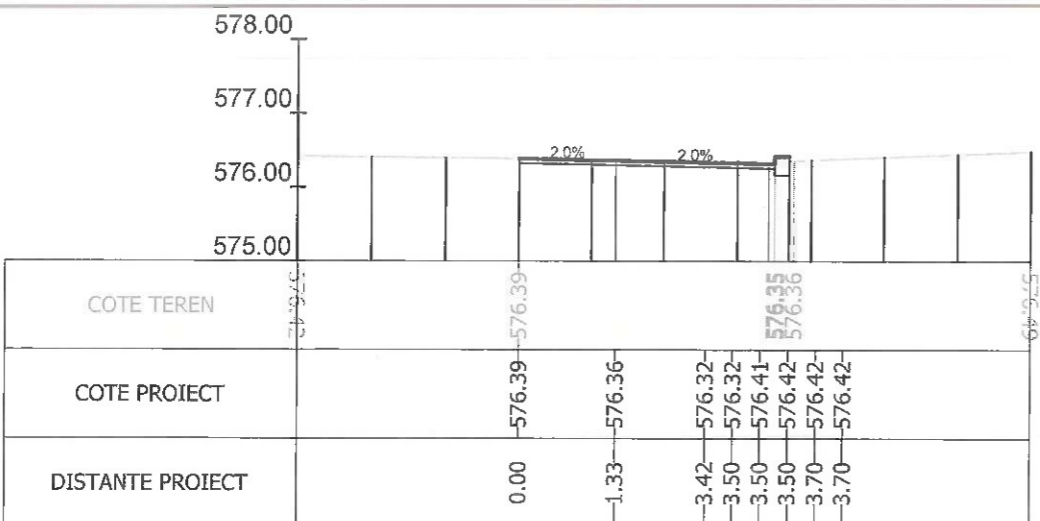

Sectiunea 177 - Km 2+375
Ax-Traseul 1

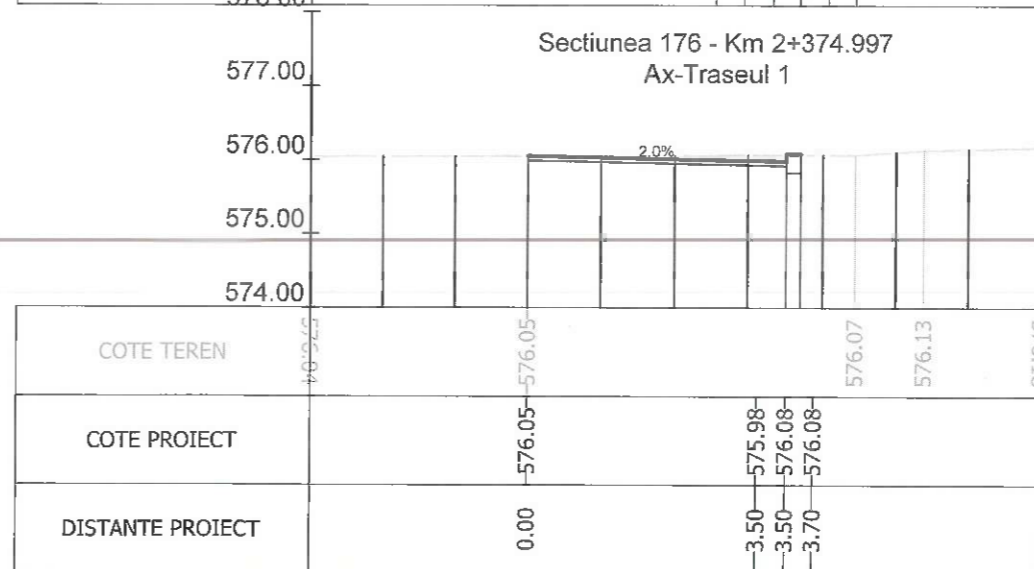

Sectiunea 178 - Km 2+400
Ax-Traseul 1

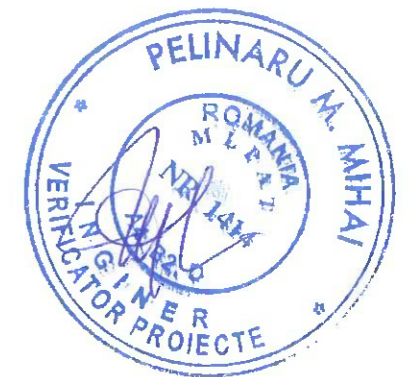

Index	A		Rev. 5
			Beneficiar: MUNICIPIUL BRASOV Bulevardul Eroilor 8, Brasov 500007
Titlu proiect: AMENAJARE BENZI DEDICATE TRANSPORTULUI PUBLIC IN MUNICIPIUL BRASOV SI TROTUARE ADIACENTE			Nr. proiect 73 / 2020
Titlu plansa: PROFILE TRANSVERSALE CURENTE			Faza P.T.
Sef Proiect	Ing. A. Buta		Nr. plansa PT-26
Proiectat	Ing. A. Buta		
Desenat	Ing. S. Patroi		
Verificat			
Scara		1/100	
Data		07/2023	

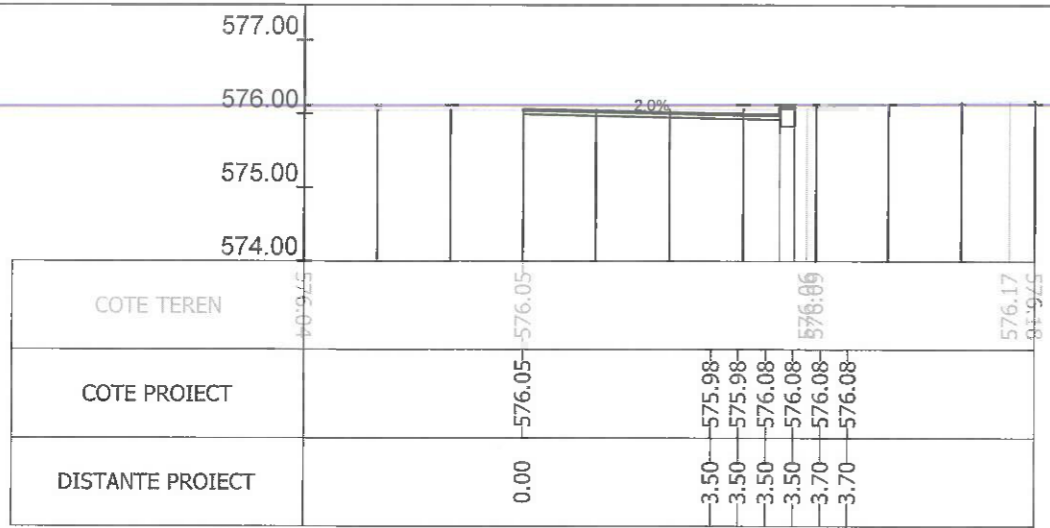

Sectiunea 179 - Km 2+403.881
Ax-Traseul 1

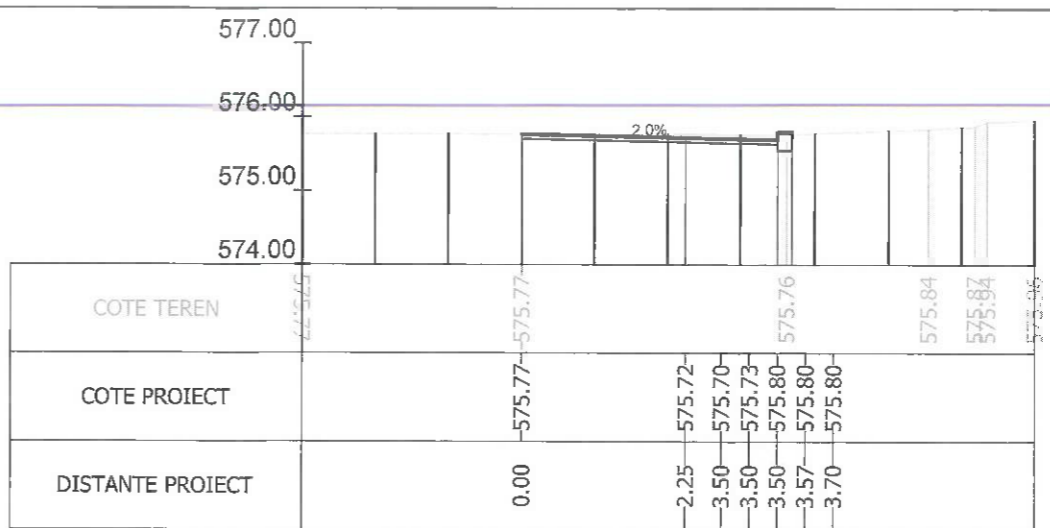
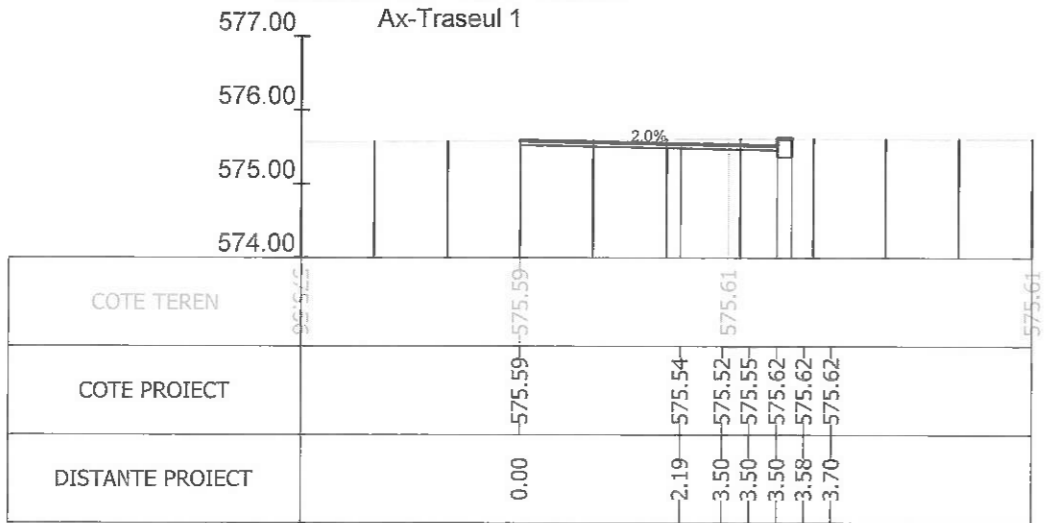

Sectiunea 180 - Km 2+425
Ax-Traseul 1

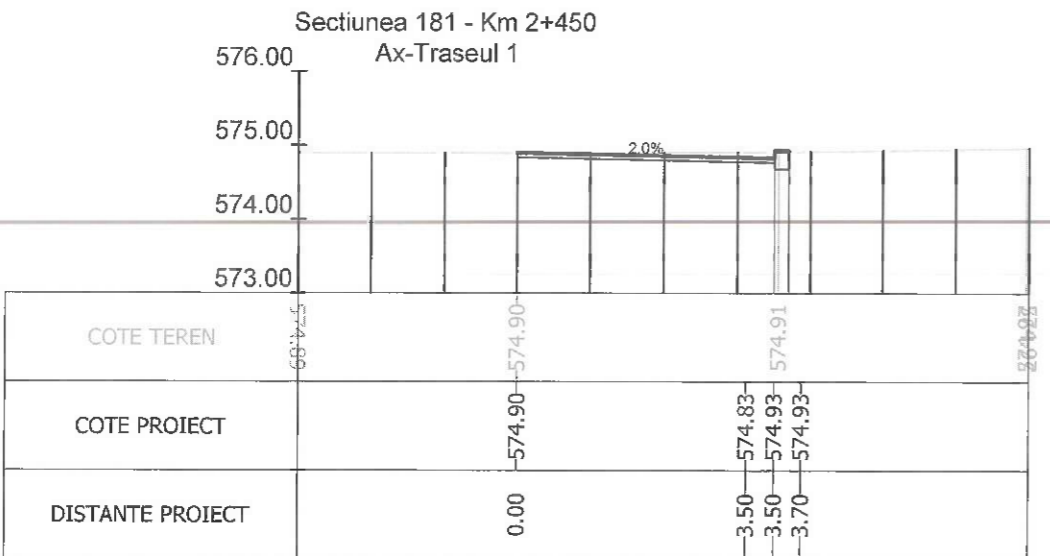
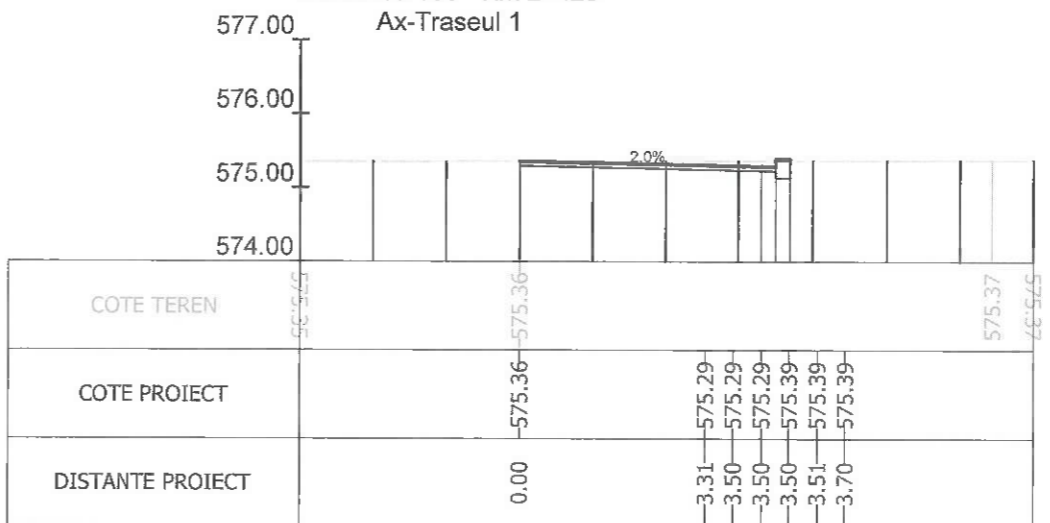

Sectiunea 181 - Km 2+450
Ax-Traseul 1

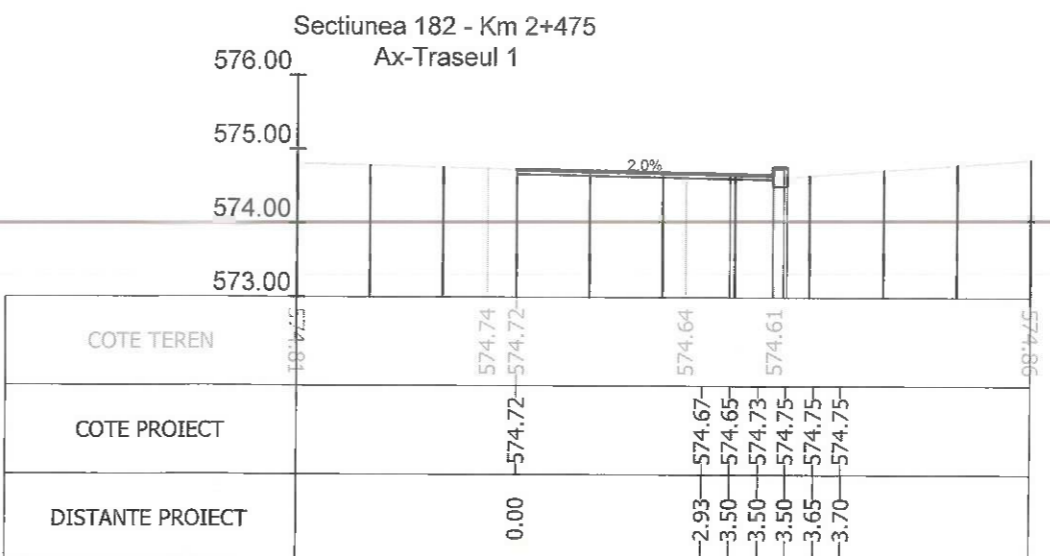

Sectiunea 182 - Km 2+475
Ax-Traseul 1

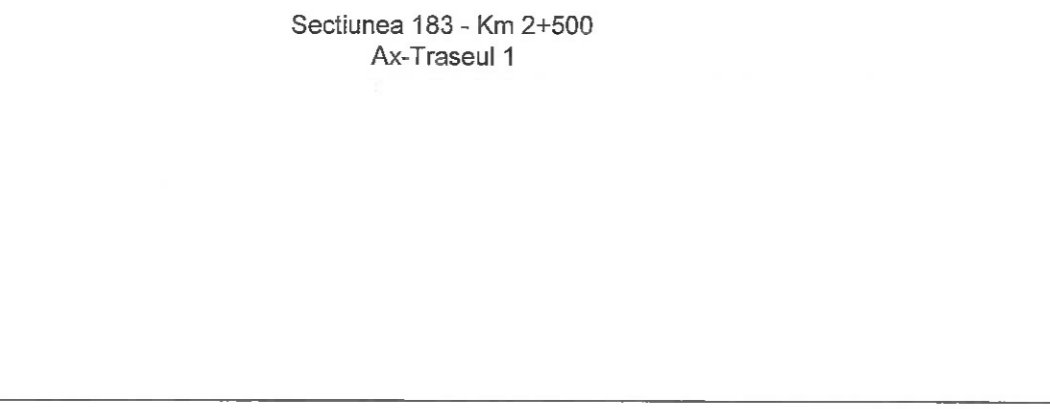

Sectiunea 183 - Km 2+500
Ax-Traseul 1

Index	A		Rev. 5
			
Beneficiar:		MUNICIPIUL BRASOV Bulevardul Eroilor 8, Brasov 500007	Nr. proiect 73 / 2020
Titlu proiect:		AMENAJARE BENZI DEDICATE TRANSPORTULUI PUBLIC IN MUNICIPIUL BRASOV SI TROTUARE ADIACENTE	Faza P.T.
Titlu plansa:		PROFILE TRANSVERSALE CURENTE	Nr. plansa PT-27
Sef Proiect	Ing. A. Buta	Scara	1/100
Proiectat	Ing. A. Buta	Data	07/2023
Desenat	Ing. S. Patroi		
Verificat			



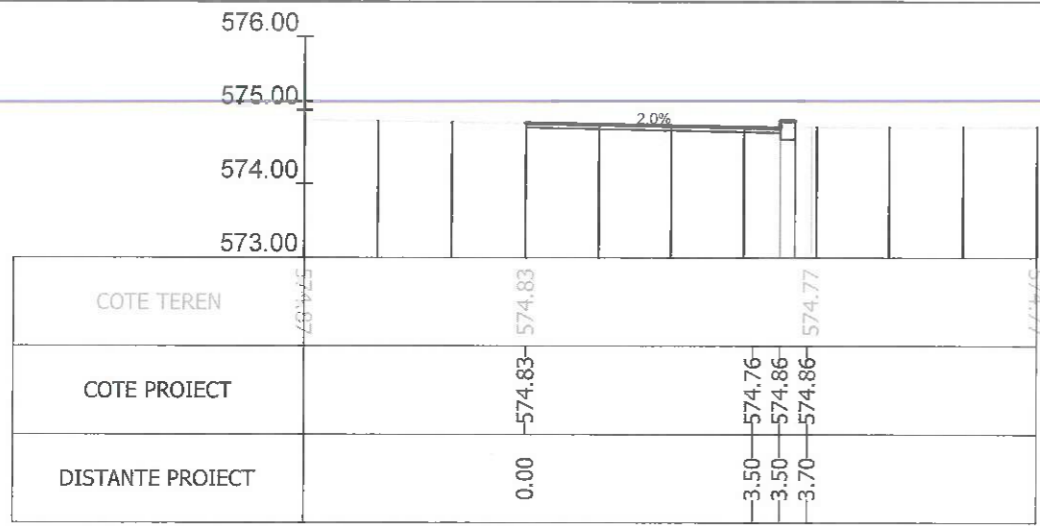

Sectiunea 185 - Km 2+518.366
Ax-Traseul 1

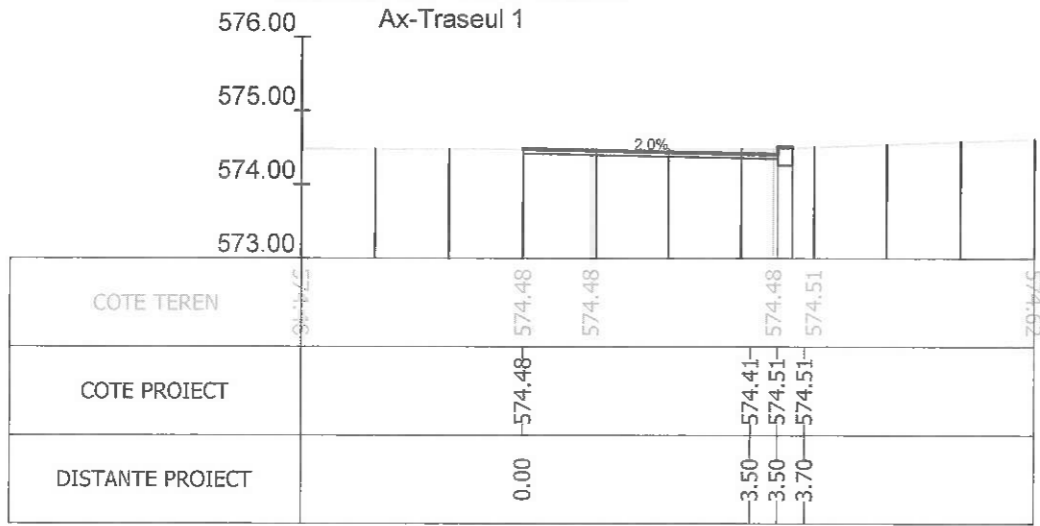

Sectiunea 186 - Km 2+525
Ax-Traseul 1

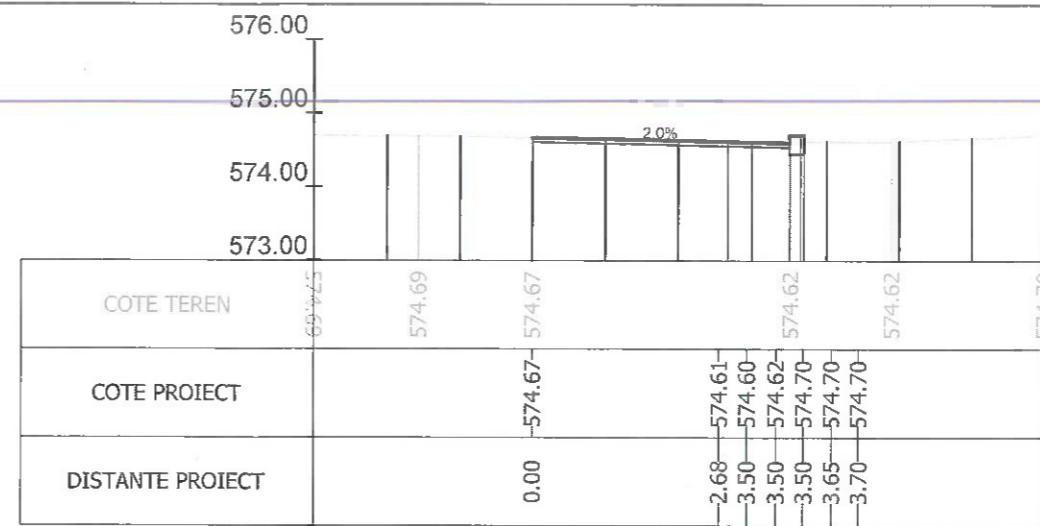

Sectiunea 188 - Km 2+542.240
Ax-Traseul 1

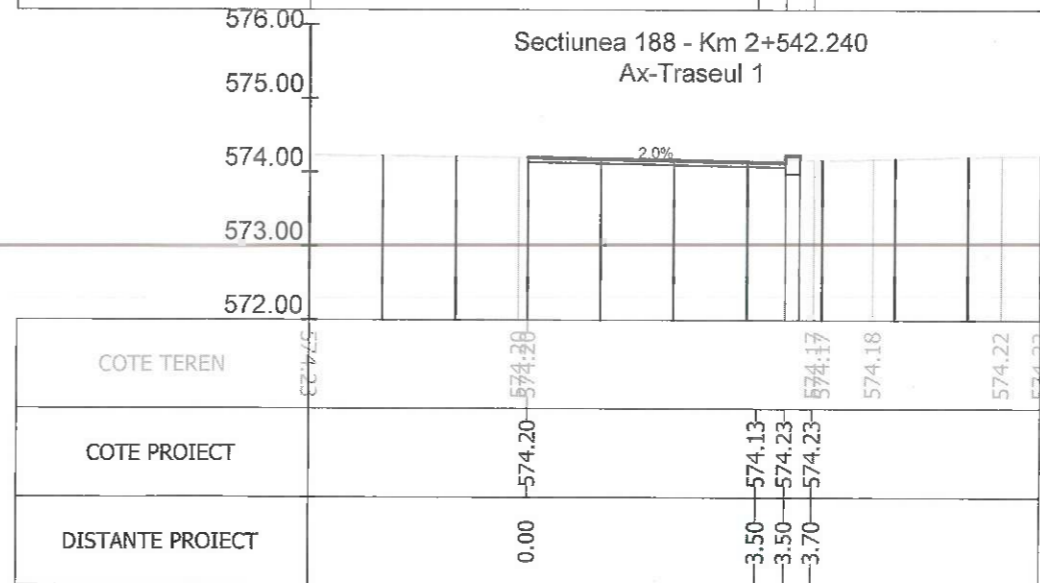

Sectiunea 189 - Km 2+550
Ax-Traseul 1

Sectiunea 190 - Km 2+553.389
Ax-Traseul 1

Index	Data	Observatii	Rev. 5
A			
		Beneficiar:	MUNICIPIUL BRASOV Bulevardul Eroilor 8, Brasov 500007
Sef Proiect: Ing. A. Buta Proiectat: Ing. A. Buta Desenat: Ing. S. Patroi Verificat:		Titlu proiect:	AMENAJARE BENZI DEDICATE TRANSPORTULUI PUBLIC IN MUNICIPIUL BRASOV SI TROTUARE ADIACENTE
Scara: 1/100 Data: 07/2023		Titlu plansa:	PROFILE TRANSVERSALE CURENTE
		Nr. proiect	73 / 2020
		Faza	P.T.
		Nr. plansa	PT-28

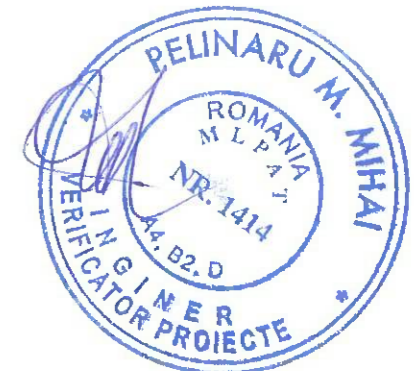

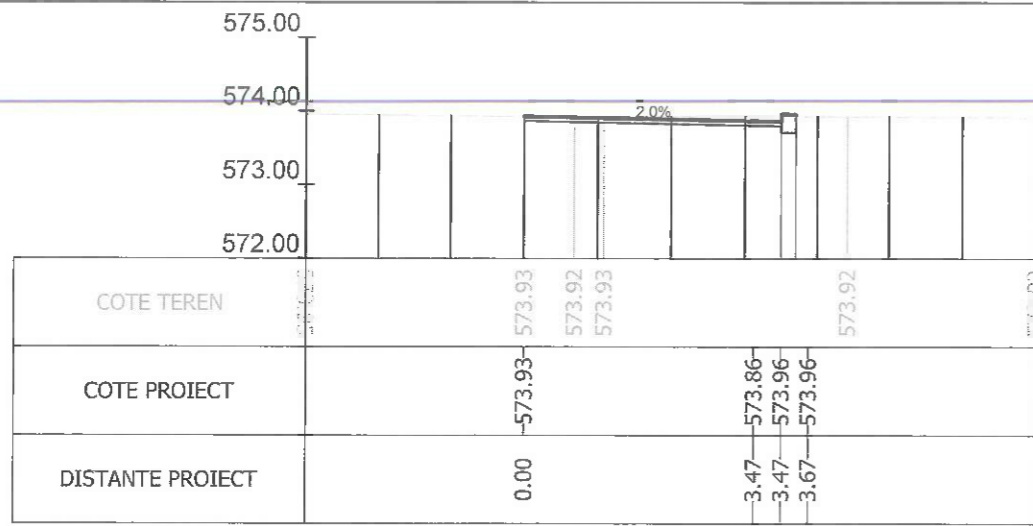

Sectiunea 191 - Km 2+570.241
Ax-Traseul 1

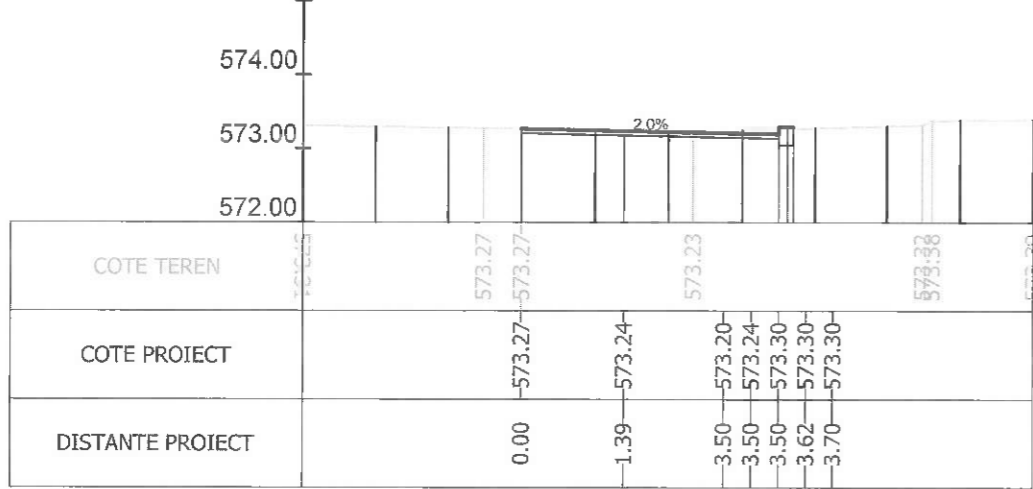

Sectiunea 196 - Km 2+625
Ax-Traseul 1

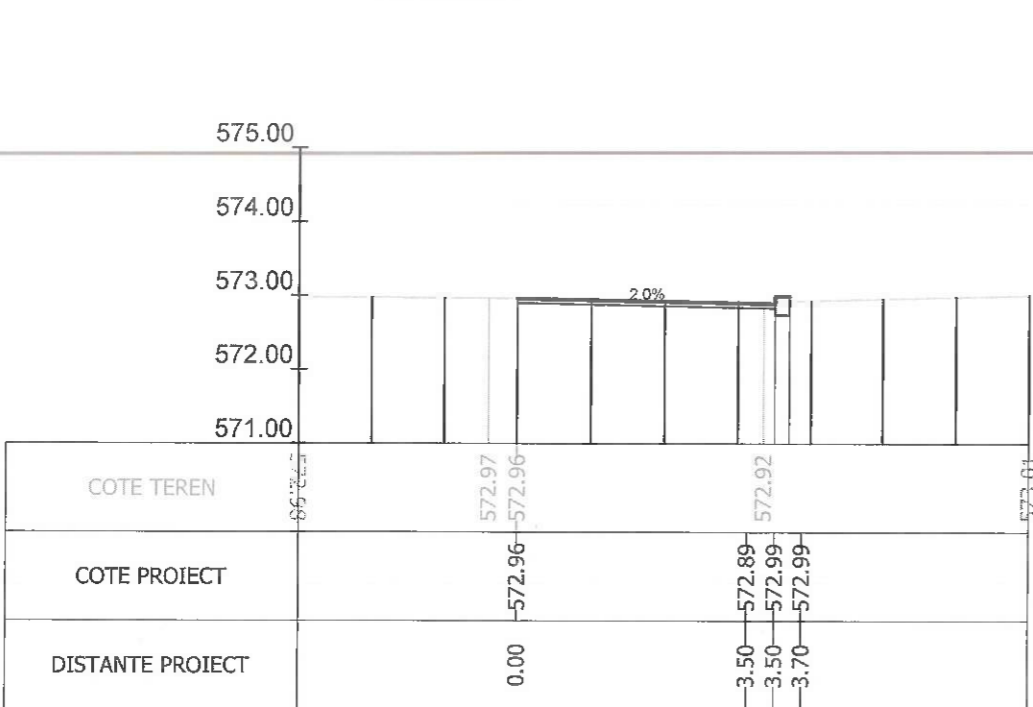

Sectiunea 198 - Km 2+650
Ax-Traseul 1

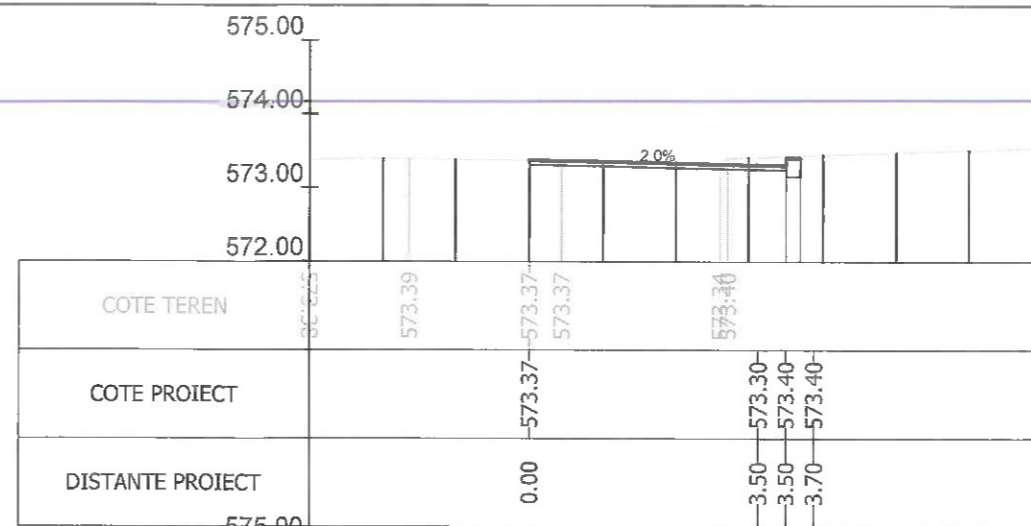

Sectiunea 195 - Km 2+620.246
Ax-Traseul 1

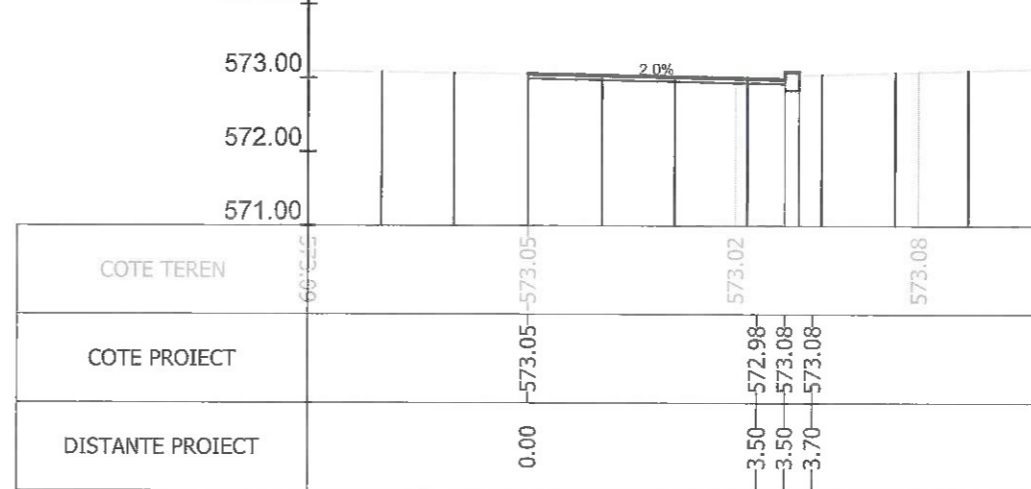

Sectiunea 197 - Km 2+639.600
Ax-Traseul 1

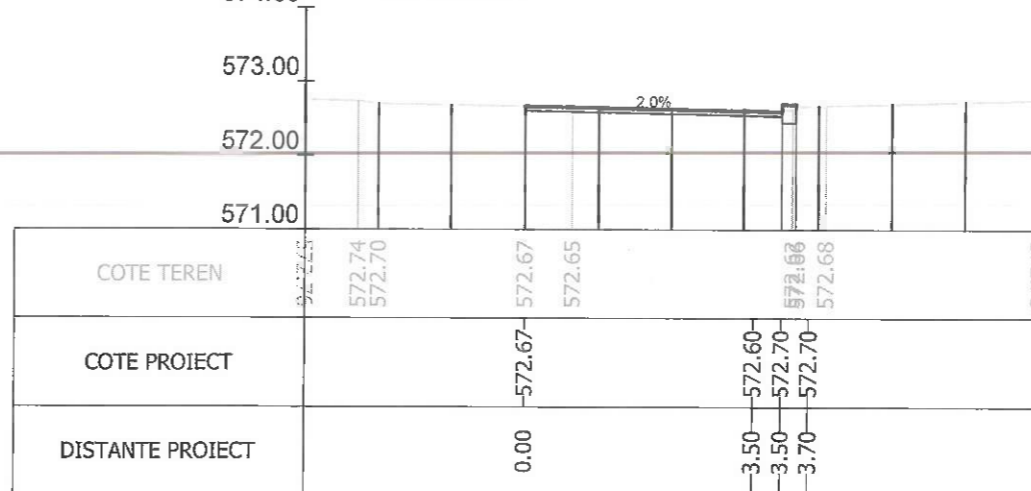

Sectiunea 199 - Km 2+669.020
Ax-Traseul 1



Index	Data	Observatii	Rev. 5
A			
		Beneficiar:	MUNICIPIUL BRASOV Bulevardul Eroilor 8, Brasov 500007
<small>SEOL, PRESENTARE NR. 17 BUCUR, 2 ETALAJ, VALLETTARI ILUTAI, TEL. +40 238 424 2449, EMAIL OFFICE@HENTZA.RO</small>		Titlu proiect:	AMENAJARE BENZI DEDICATE TRANSPORTULUI PUBLIC IN MUNICIPIUL BRASOV SI TROTUARE ADIACENTE
Sef Proiect	Ing. A. Buta	Titlu plansa:	PROFILE TRANSVERSALE CURENTE
Proiectat	Ing. A. Buta		
Desenat	Ing. S. Patroi		
Verificat			
	Scara		Nr. proiect
	1/100		73 / 2020
	Data		Faza
	07/2023		P.T.
			Nr. plansa
			PT-29

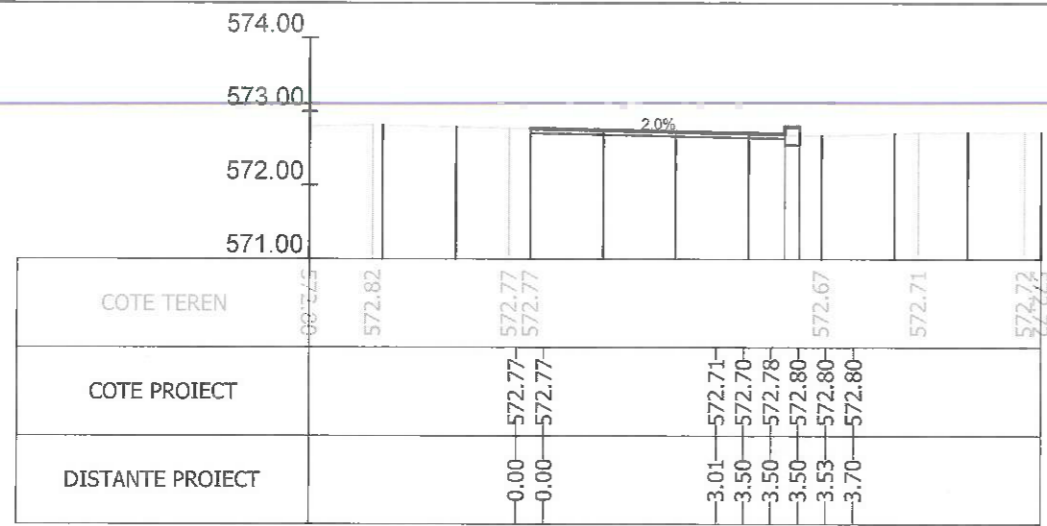

Sectiunea 200 - Km 2+675
Ax-Traseul 1

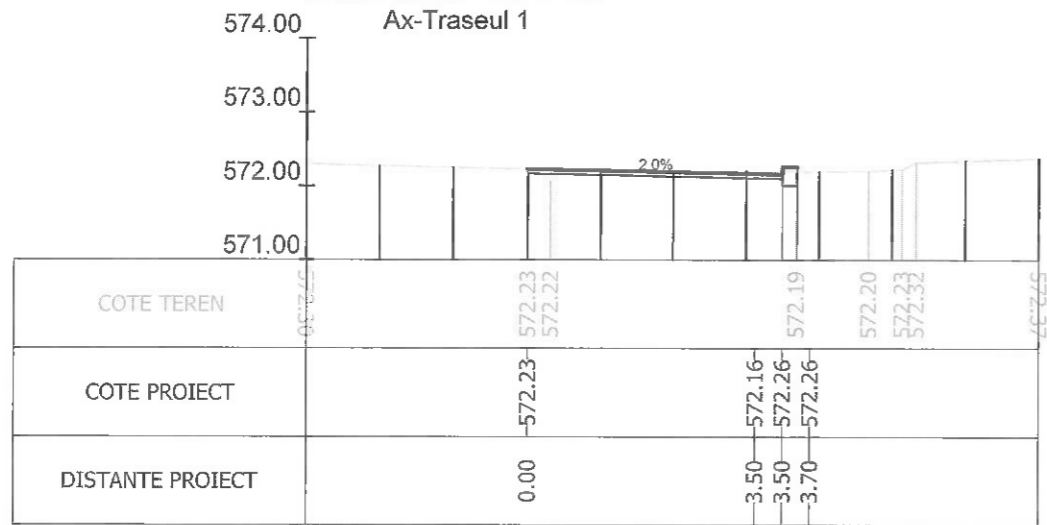

Sectiunea 202 - Km 2+700
Ax-Traseul 1

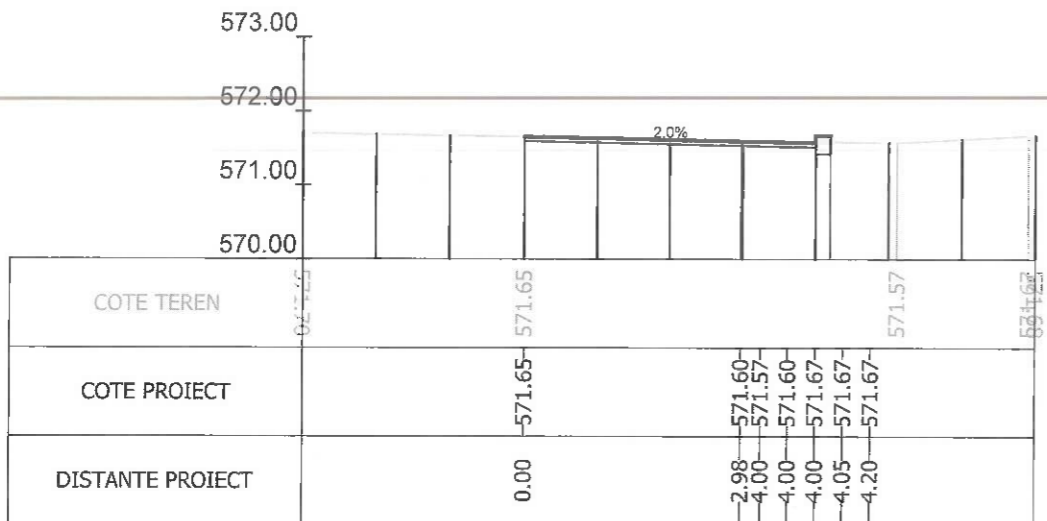

Sectiunea 204 - Km 2+750
Ax-Traseul 1

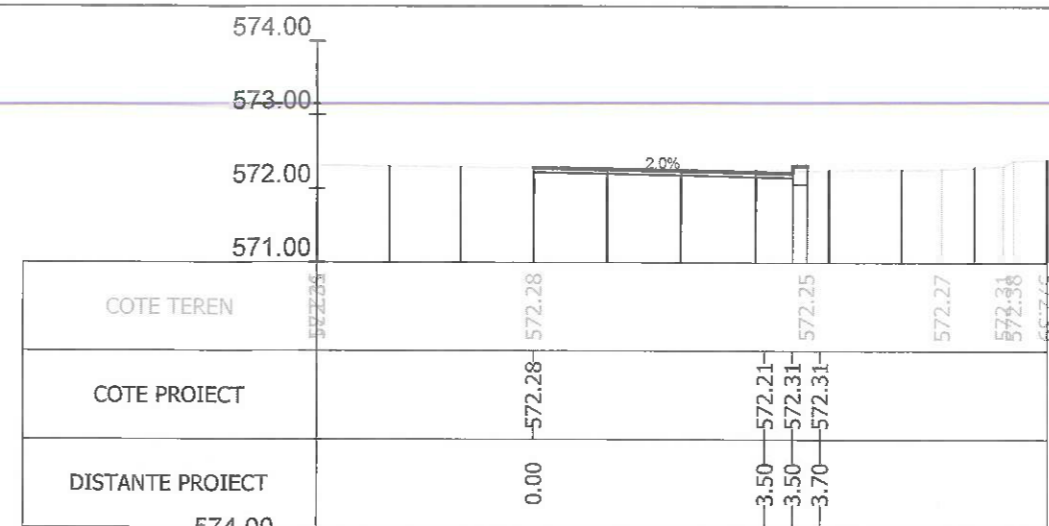

Sectiunea 201 - Km 2+698.439
Ax-Traseul 1

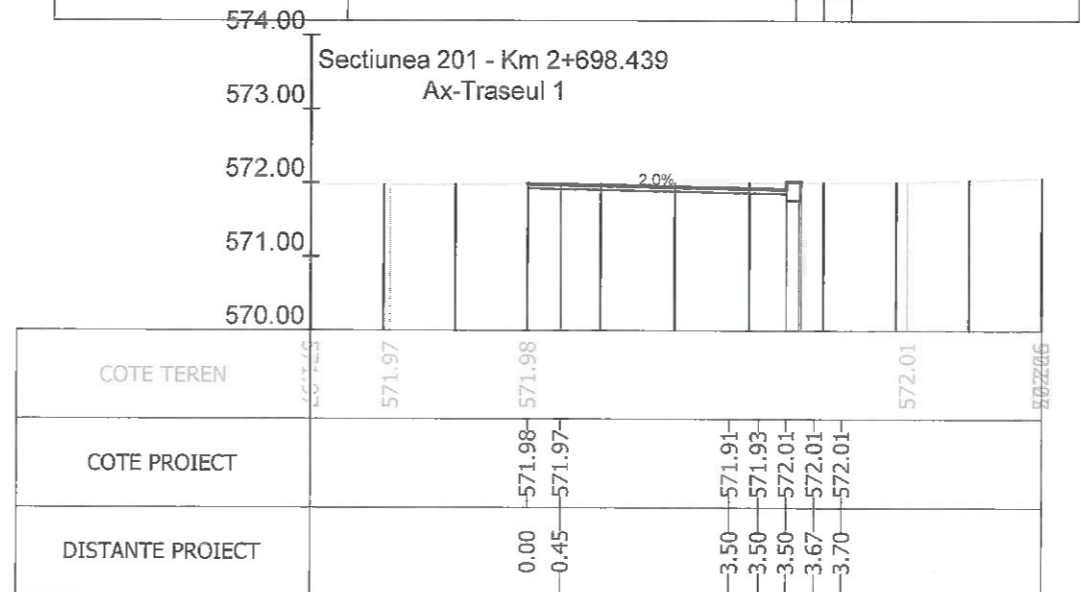

Sectiunea 203 - Km 2+725
Ax-Traseul 1

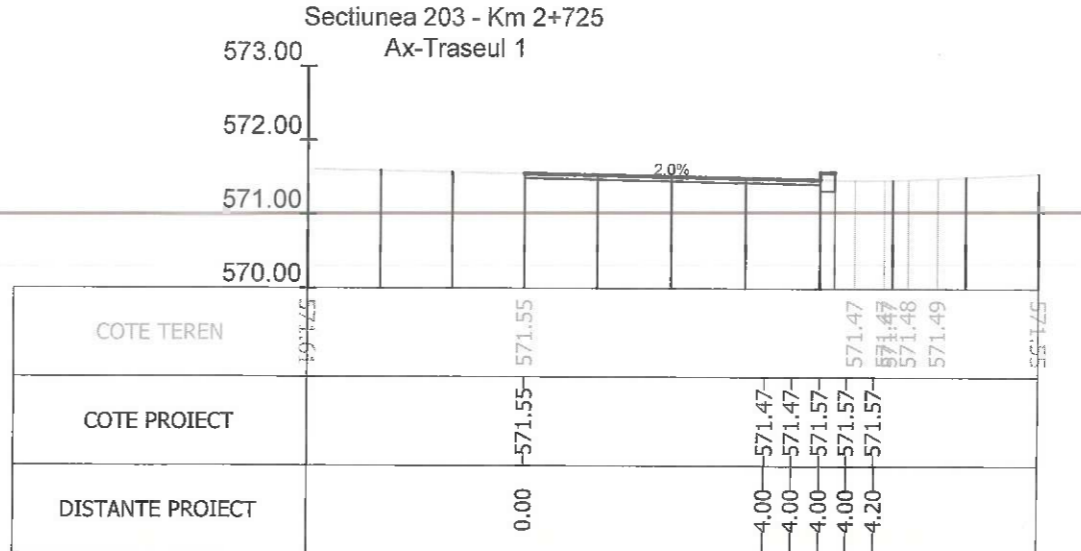

Sectiunea 205 - Km 2+754.427
Ax-Traseul 1

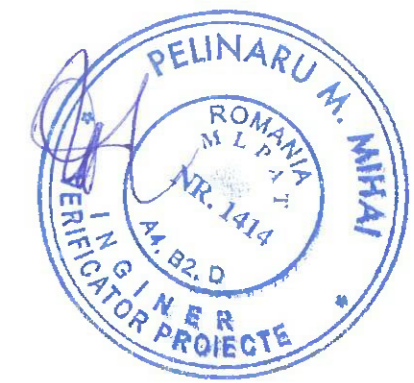

Index	A		Rev. 5
Beneficiar:	MUNICIPIUL BRASOV Bulevardul Eroilor 8, Brasov 500007	Nr. proiect	73 / 2020
Titlu proiect:	AMENAJARE BENZI DEDICATE TRANSPORTULUI PUBLIC IN MUNICIPIUL BRASOV SI TROTUARE ADIACENTE	Faza	P.T.
Titlu plansa:	PROFILE TRANSVERSALE CURENTE	Nr. plansa	PT-30
Sef Proiect	Ing. A. Buta	Scara	1/100
Proiectat	Ing. A. Buta	Data	07/2023
Desenat	Ing. S. Patroi		
Verificat			

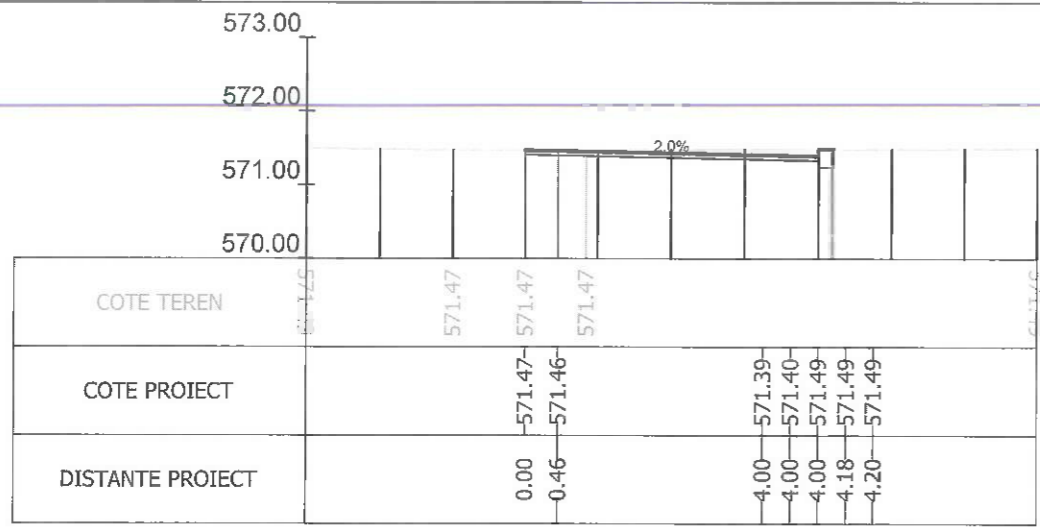

Sectiunea 206 - Km 2+775
Ax-Traseul 1

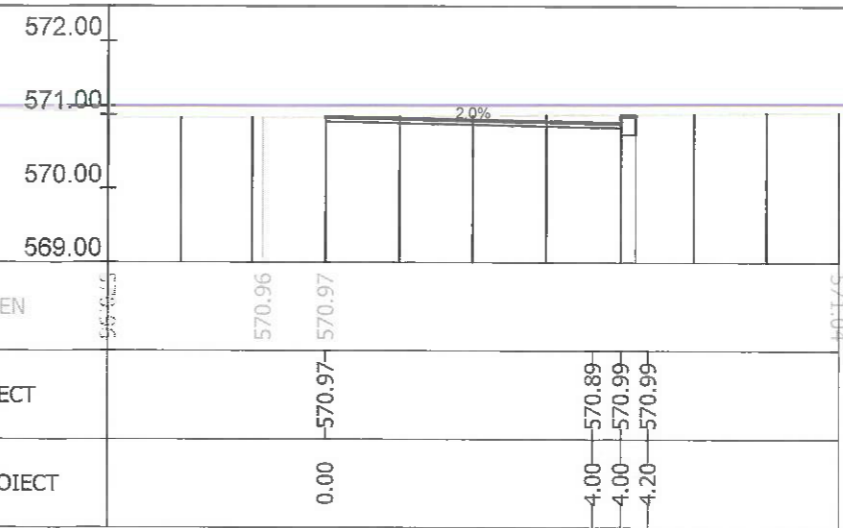
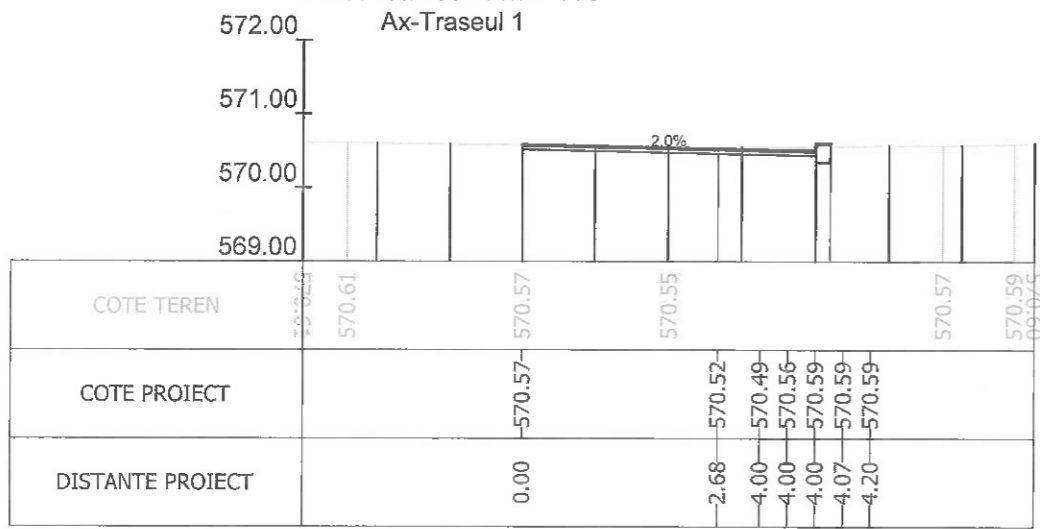

Sectiunea 207 - Km 2+800
Ax-Traseul 1

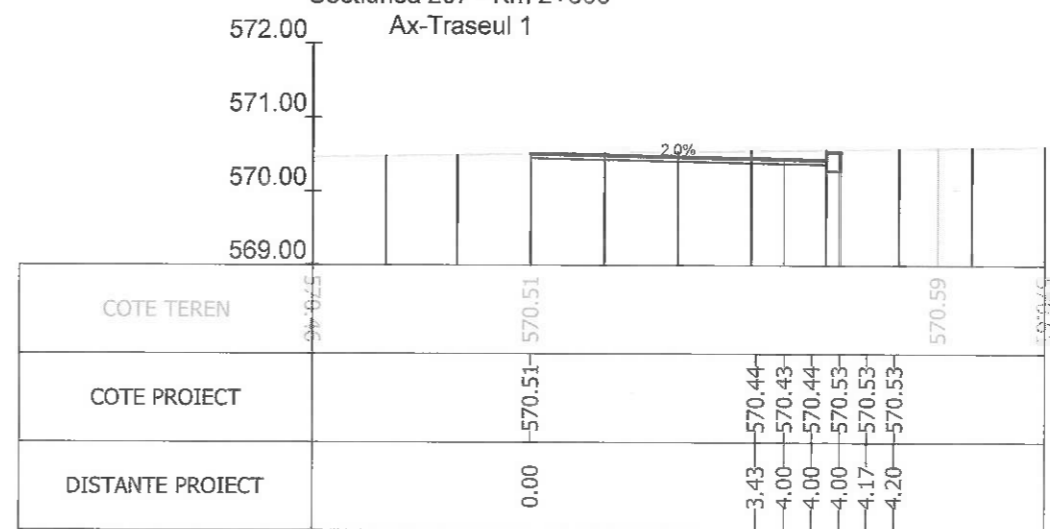

Sectiunea 209 - Km 2+850
Ax-Traseul 1

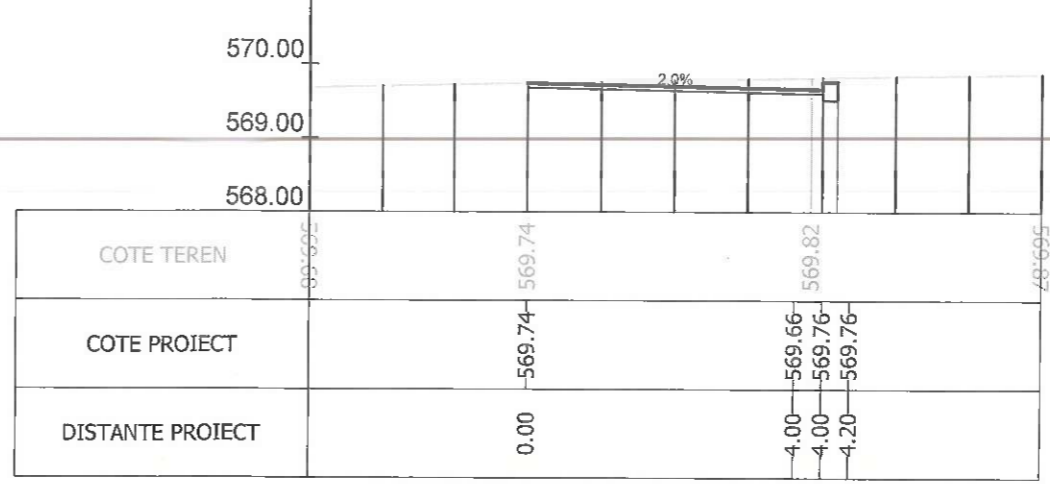

Sectiunea 210 - Km 2+875
Ax-Traseul 1

Sectiunea 211 - Km 2+900
Ax-Traseul 1

Index	Data	Rev. 5
A		
		Beneficiar: MUNICIPIUL BRASOV Bulevardul Eroilor 8, Brasov 500007
Sef Proiect	Ing. A. Buta	Nr. proiect: 73 / 2020
Proiectat	Ing. A. Buta	Titlu proiect: AMENAJARE BENZI DEDICATE TRANSPORTULUI PUBLIC IN MUNICIPIUL BRASOV SI TROTUARE ADIACENTE
Desenat	Ing. S. Patroi	Faza P.T.
Verificat		Titlu plansa: PROFILE TRANSVERSALE CURENTE
	Scara 1/100	Nr. plansa: PT-31
	Data 07/2023	



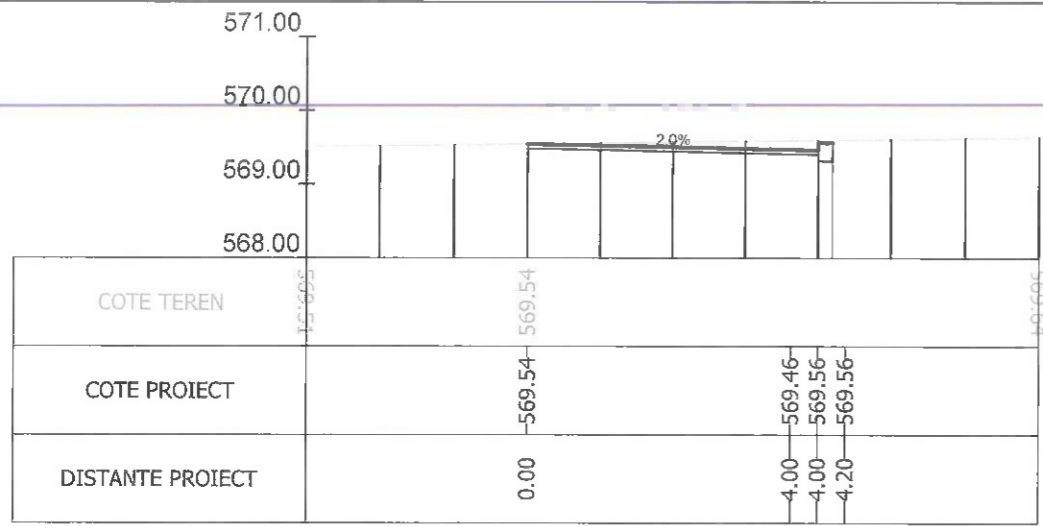

Sectiunea 212 - Km 2+913.633
Ax-Traseul 1

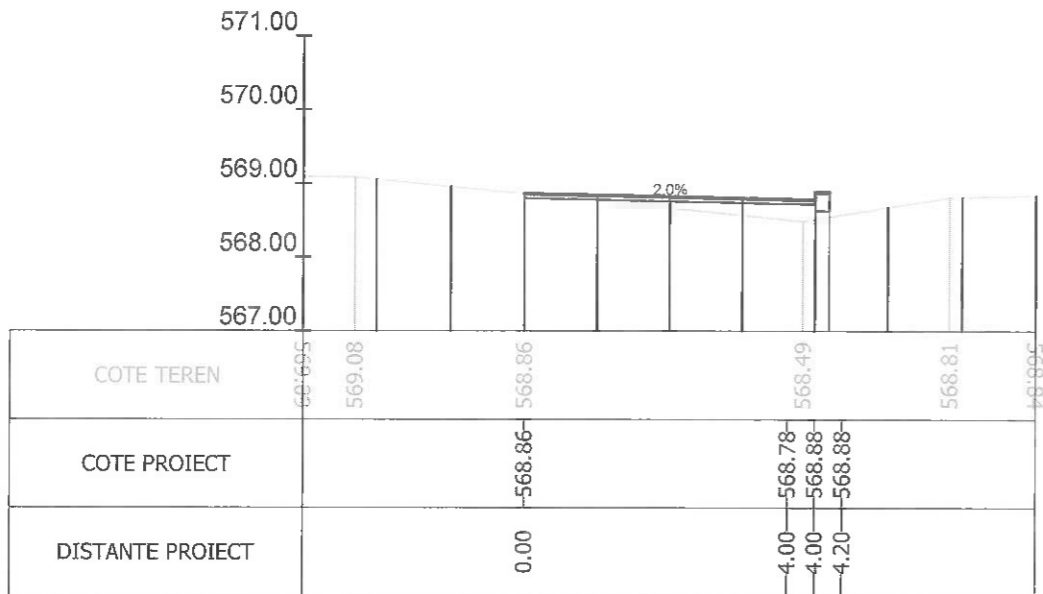

Sectiunea 220 - Km 3+000
Ax-Traseul 1

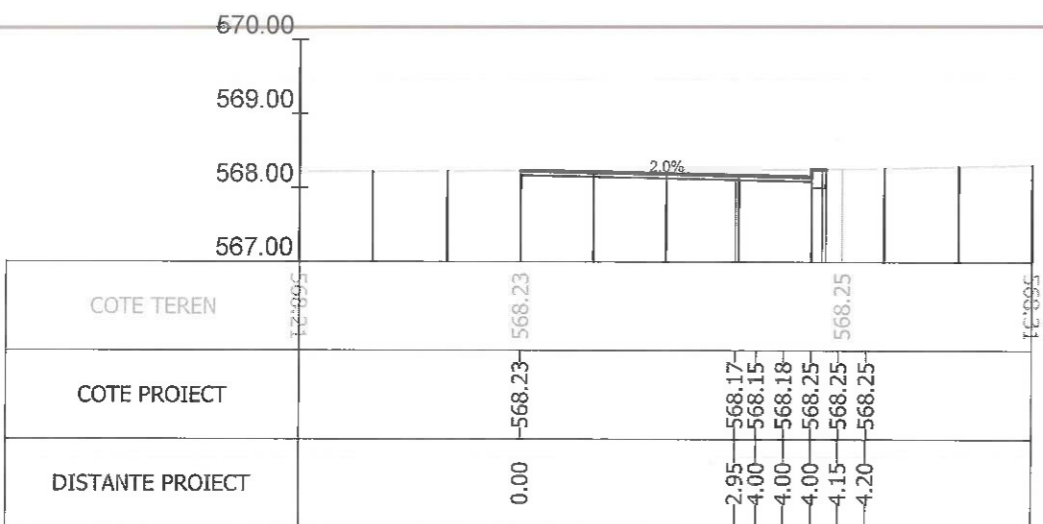

Sectiunea 222 - Km 3+025
Ax-Traseul 1

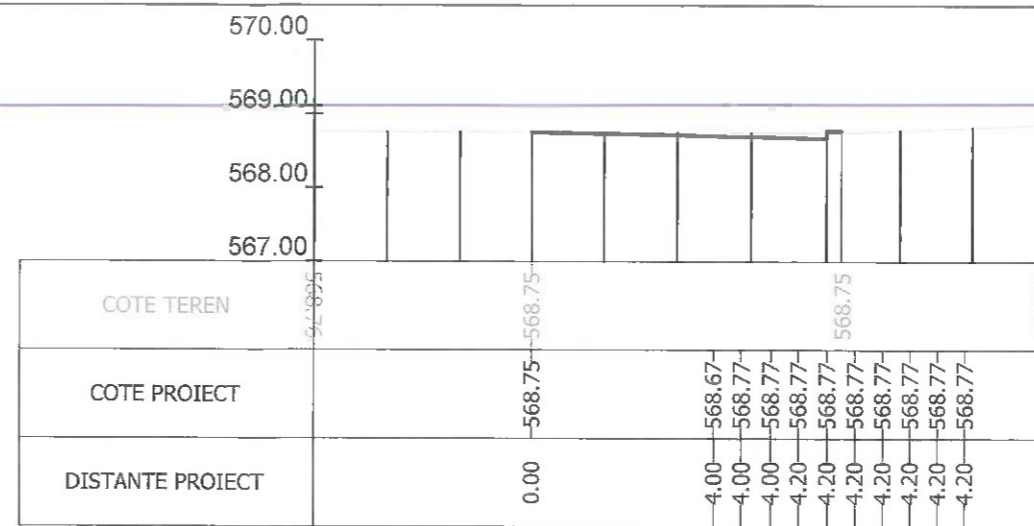

Sectiunea 219 - Km 2+983.257
Ax-Traseul 1

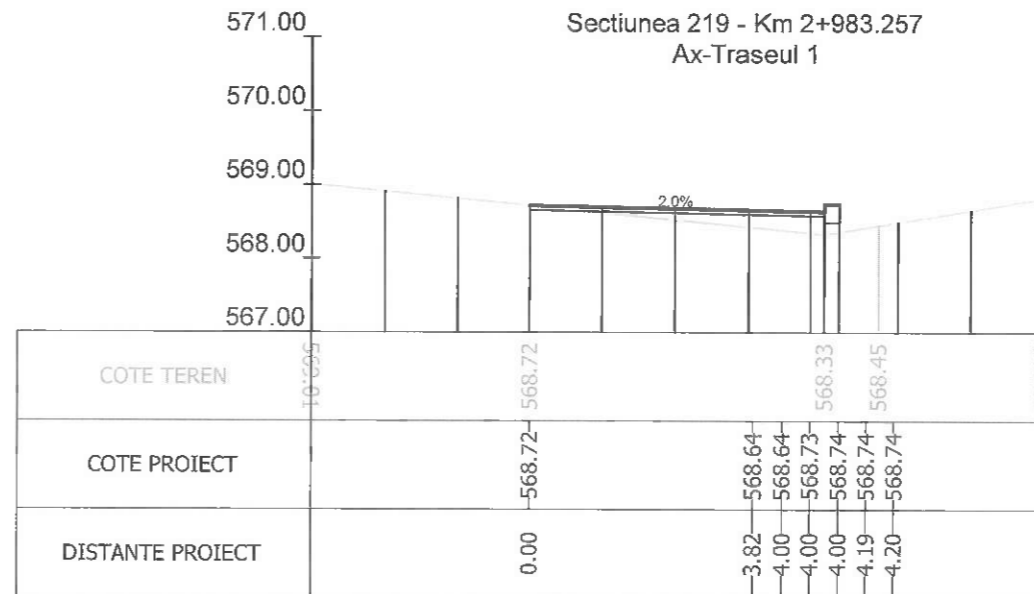

Sectiunea 221 - Km 3+012.067
Ax-Traseul 1

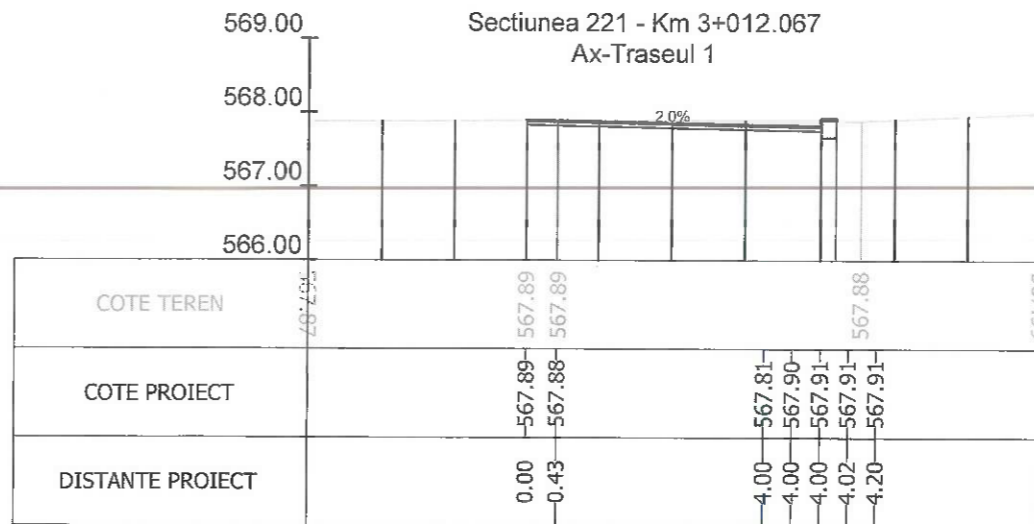

Sectiunea 223 - Km 3+050
Ax-Traseul 1

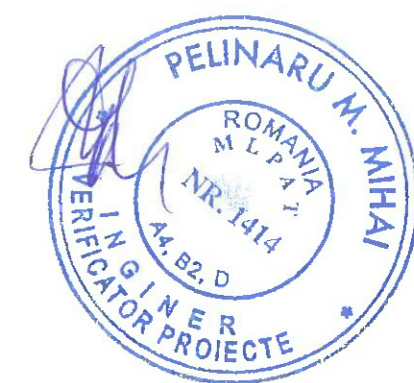

Index	Date		Rev. 5
A			
			Beneficiar: MUNICIPIUL BRASOV Bulevardul Eroilor 8, Brasov 500007
Sef Proiect: Ing. A. Buta Proiectat: Ing. A. Buta Desenat: Ing. S. Patroi Verificat:			Nr. proiect: 73 / 2020 Faza: P.T. Nr. plansa: PT-32
Scara: 1/100 Data: 07/2023			Titlu proiect: AMENAJARE BENZI DEDICATE TRANSPORTULUI PUBLIC IN MUNICIPIUL BRASOV SI TROTUARE ADIACENTE Titlu plansa: PROFILE TRANSVERSALE CURENTE

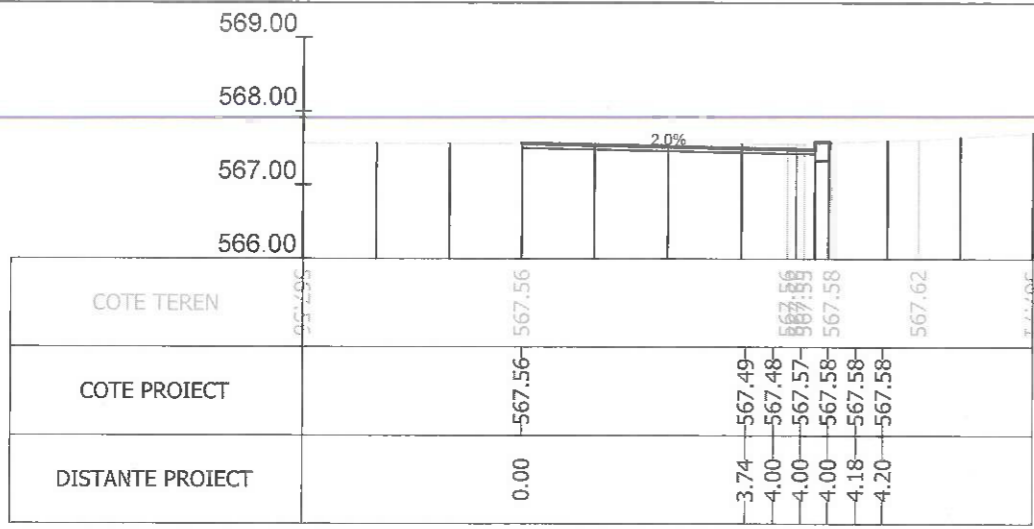

Sectiunea 224 - Km 3+070.200
Ax-Traseul 1

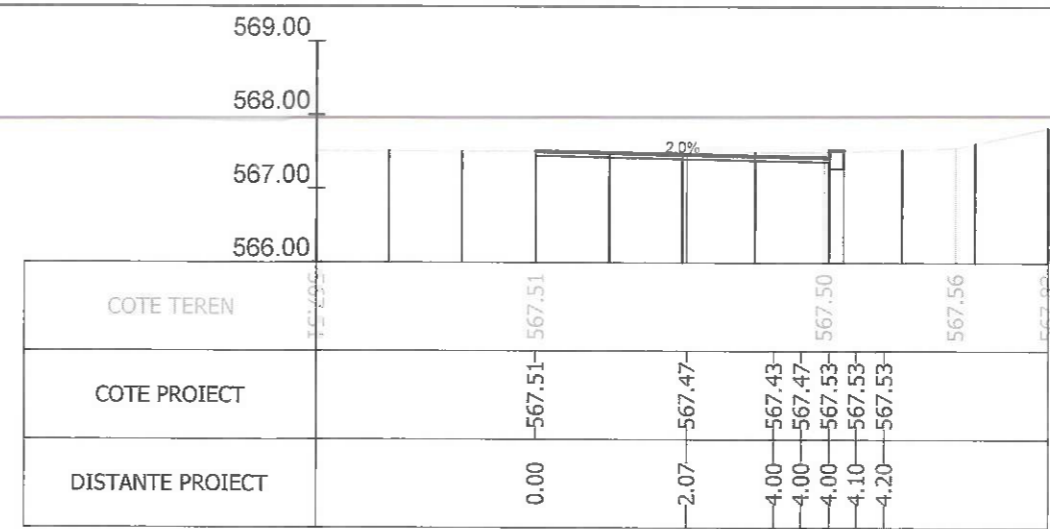

Sectiunea 225 - Km 3+075
Ax-Traseul 1

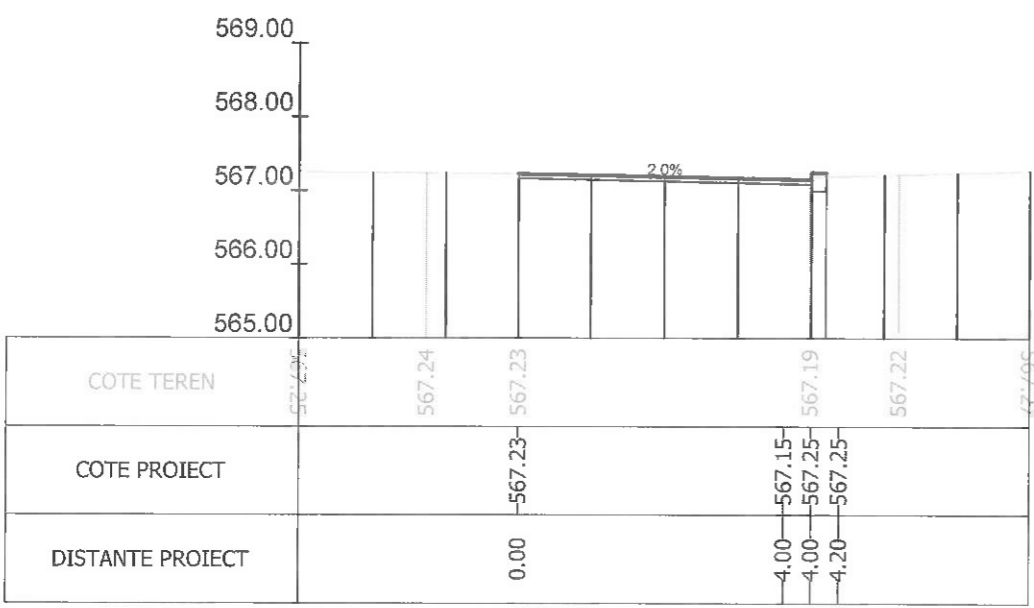

Sectiunea 226 - Km 3+100
Ax-Traseul 1

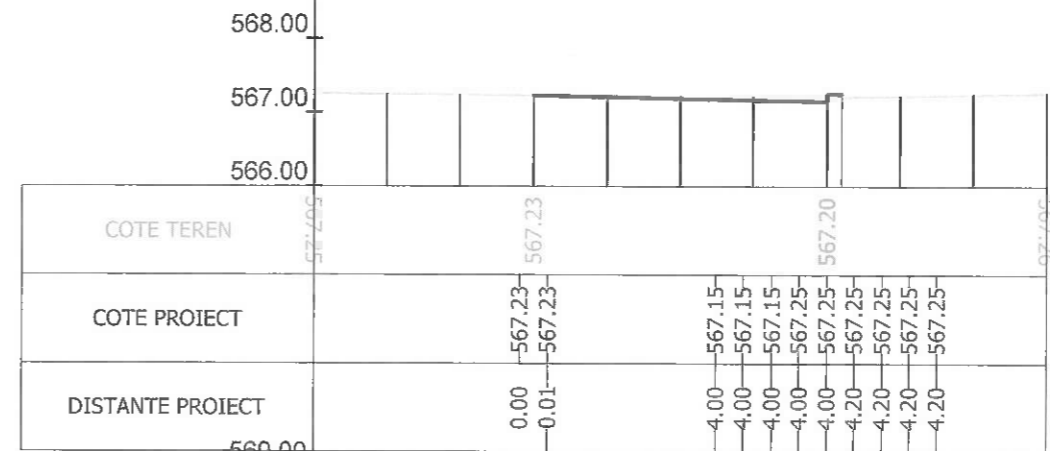

Sectiunea 227 - Km 3+100.533
Ax-Traseul 1

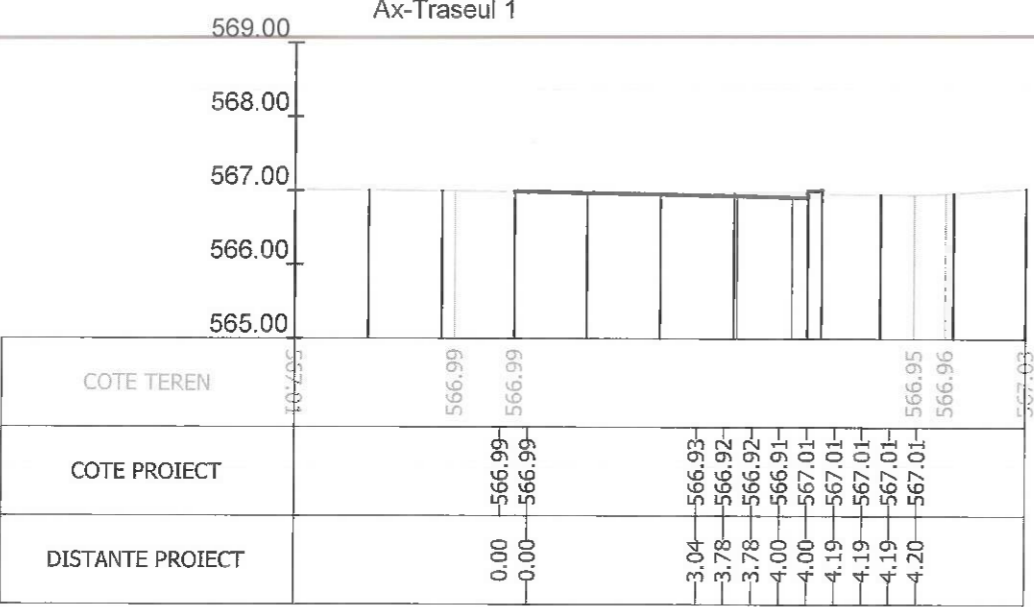

Sectiunea 229 - Km 3+150
Ax-Traseul 1

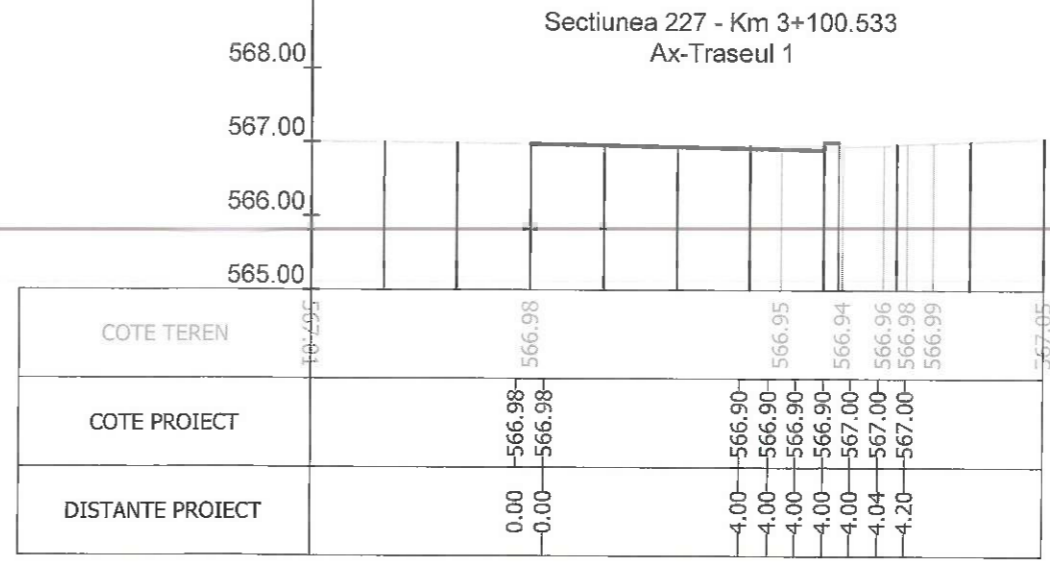

Sectiunea 230 - Km 3+152.808
Ax-Traseul 1



Index	Ax-Traseul 1		Rev. 5
A			
		Beneficiar:	MUNICIPIUL BRASOV Bulevardul Eroilor 8, Brasov 500007
Scara 1/100 Data 07/2023		Titlu proiect:	AMENAJARE BENZI DEDICATE TRANSPORTULUI PUBLIC IN MUNICIPIUL BRASOV SI TROTUARE ADIACENTE
Desenat Ing. S. Patroi		Titlu plansa:	PROFILE TRANSVERSALE CURENTE
Verificat		Nr. proiect	73 / 2020
		Faza	P.T.
		Nr. plansa	PT-33

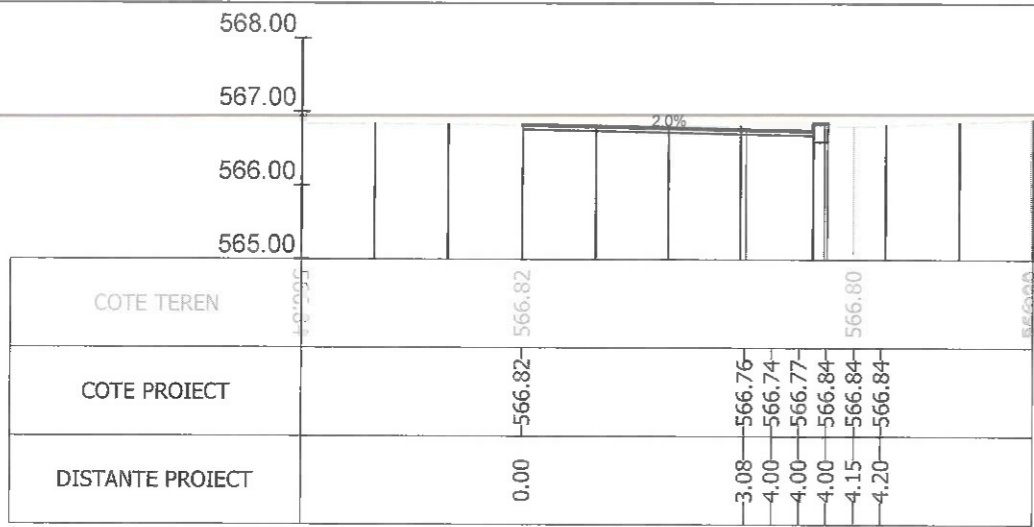

Sectiunea 231 - Km 3+175
Ax-Traseul 1

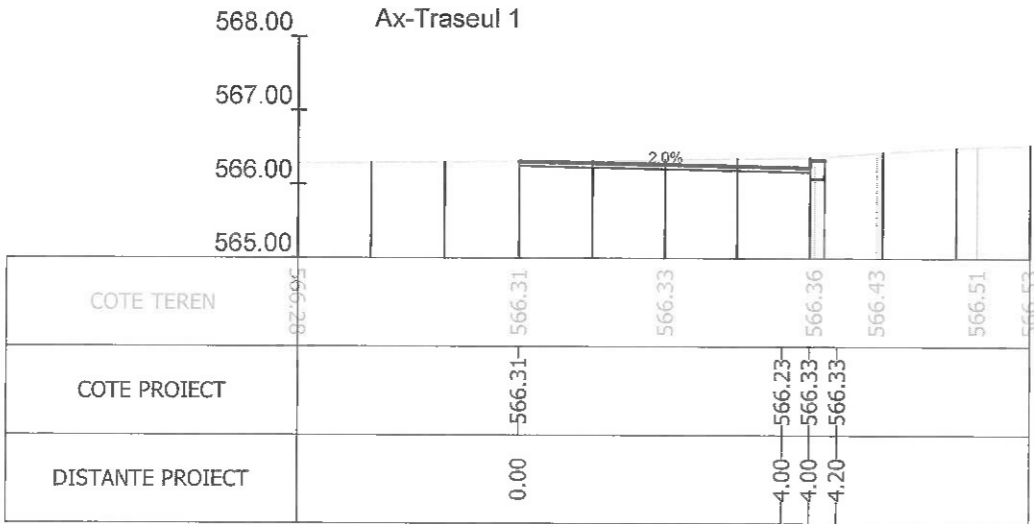

Sectiunea 233 - Km 3+224.601
Ax-Traseul 1

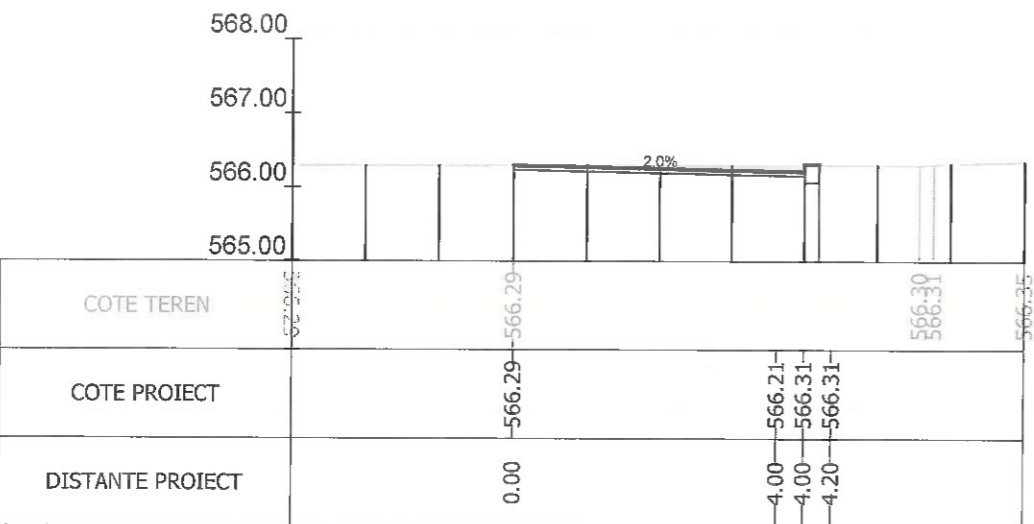

Sectiunea 235 - Km 3+234.653
Ax-Traseul 1

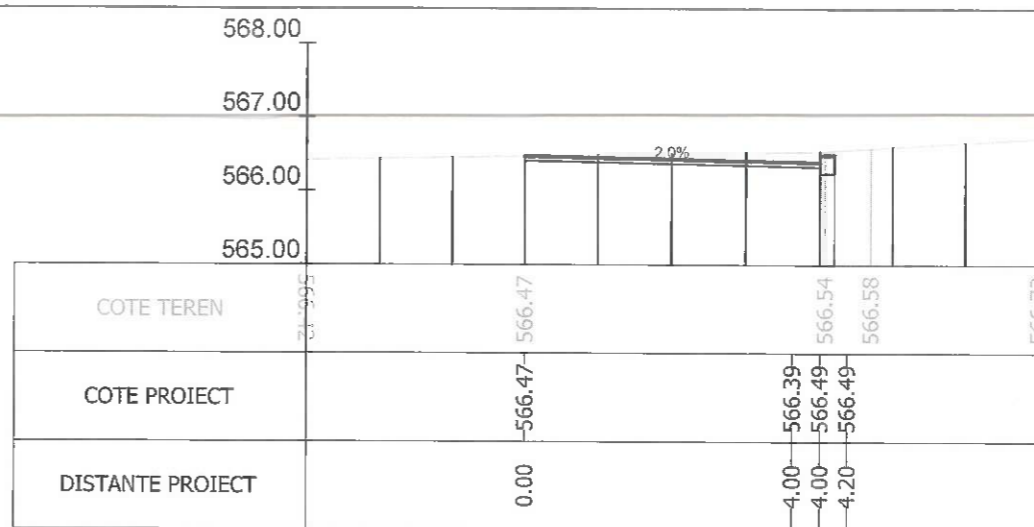

Sectiunea 232 - Km 3+200
Ax-Traseul 1

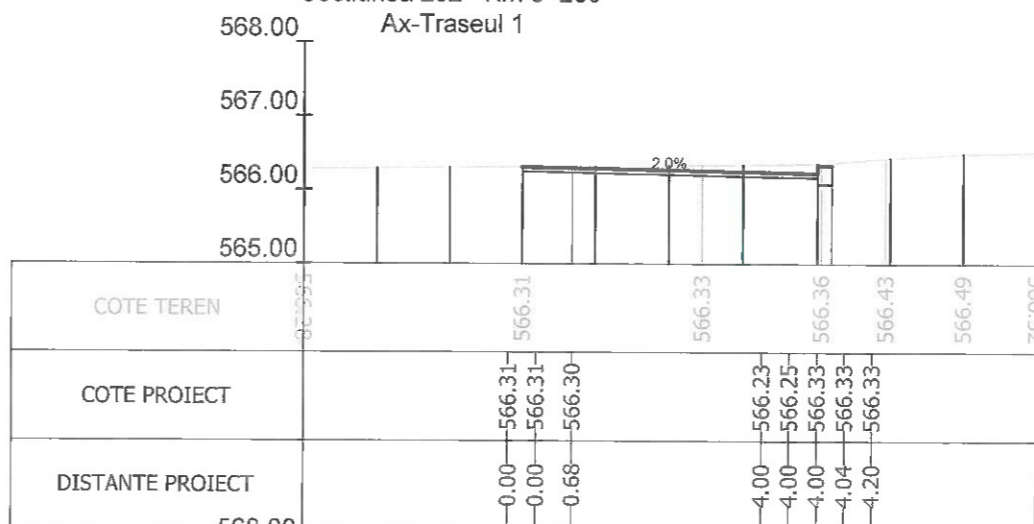

Sectiunea 234 - Km 3+225
Ax-Traseul 1

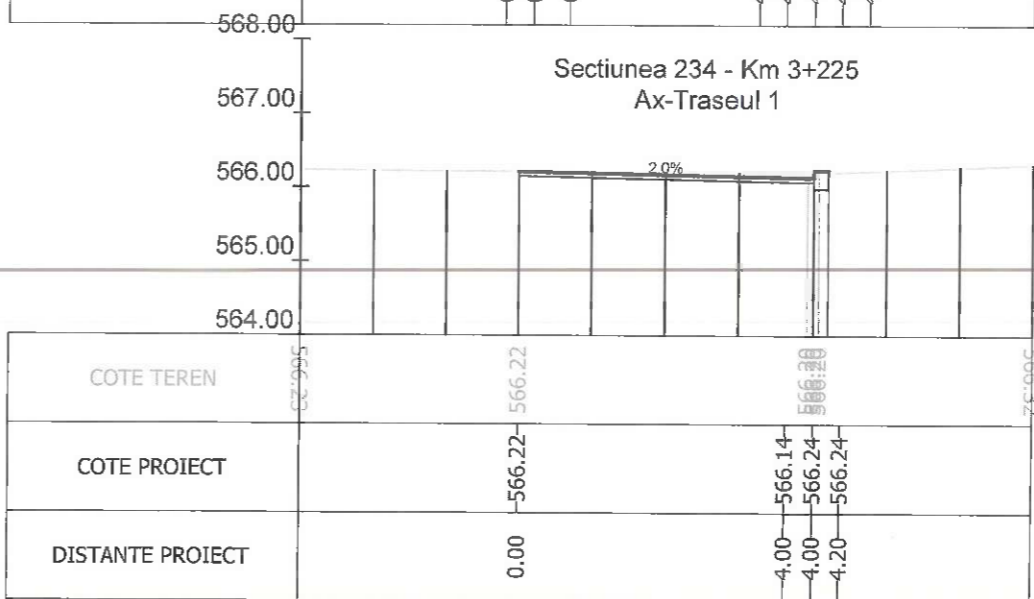

Sectiunea 236 - Km 3+244.705
Ax-Traseul 1

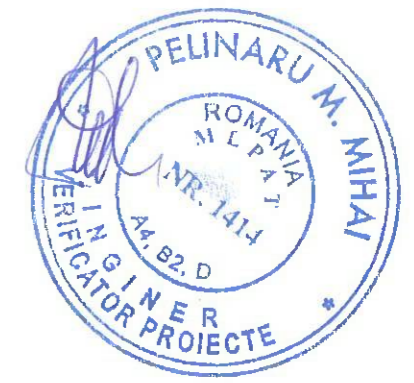

Index	A	Data	07/2023	Rev. 5
		Beneficiar: MUNICIPIUL BRASOV Bulevardul Eroilor 8, Brasov 500007		Nr. proiect 73 / 2020
Sef Proiect Ing. A. Buta Proiectat Ing. A. Buta Desenat Ing. S. Patroi Verificat		Scara 1/100 Data 07/2023		Titlu proiect: AMENAJARE BENZI DEDICATE TRANSPORTULUI PUBLIC IN MUNICIPIUL BRASOV SI TROTUARE ADIACENTE Titlu plansa: PROFILE TRANSVERSALE CURENTE
				Faza P.T. Nr. plansa PT-34

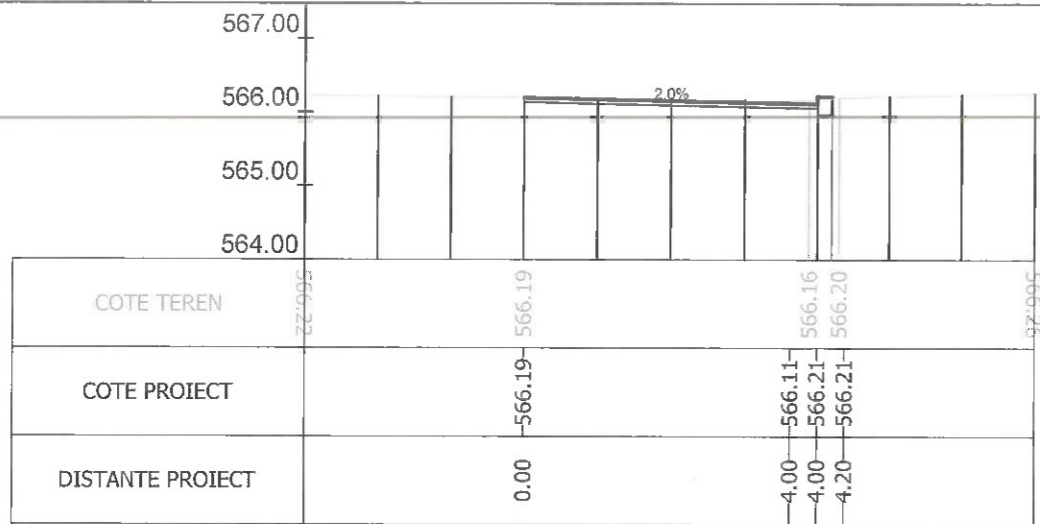

Sectiunea 237 - Km 3+250
Ax-Traseul 1

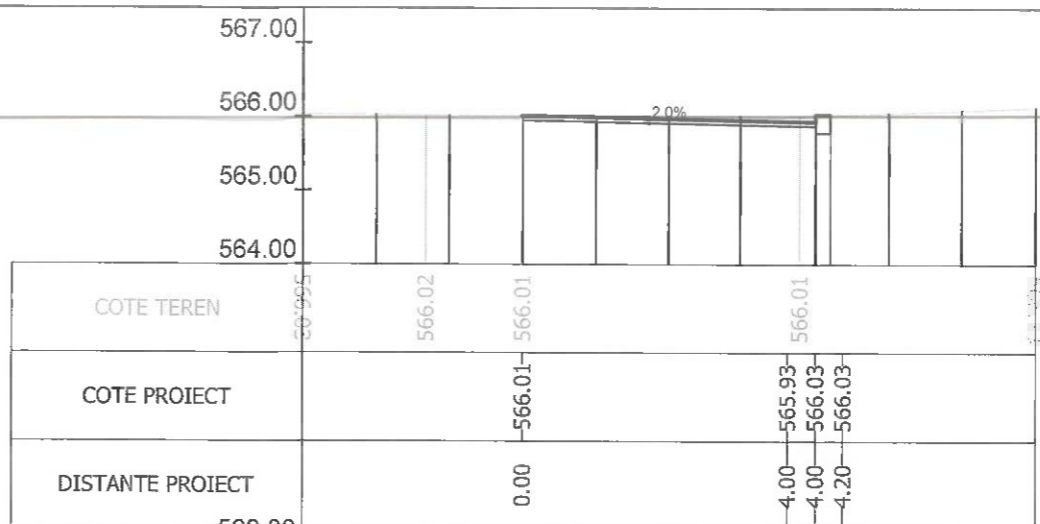

Sectiunea 238 - Km 3+269.946
Ax-Traseul 1

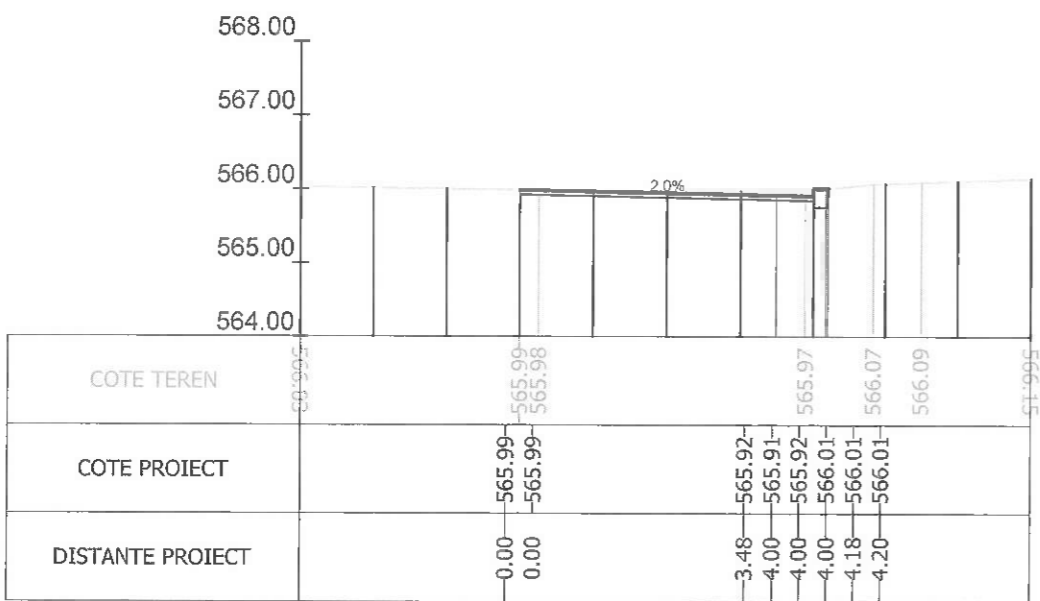

Sectiunea 239 - Km 3+275
Ax-Traseul 1

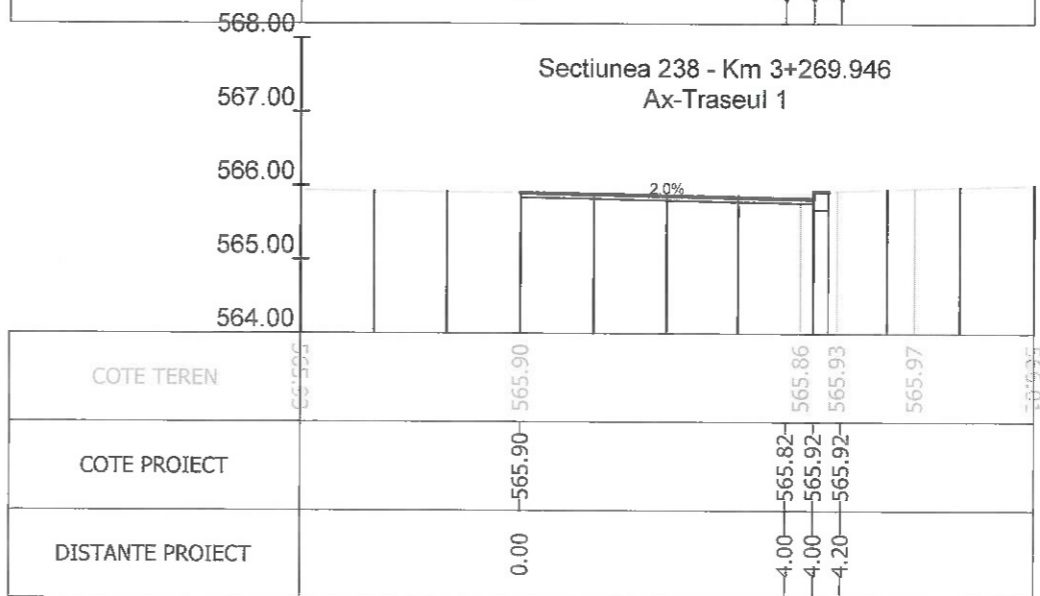

Sectiunea 240 - Km 3+295.187
Ax-Traseul 1

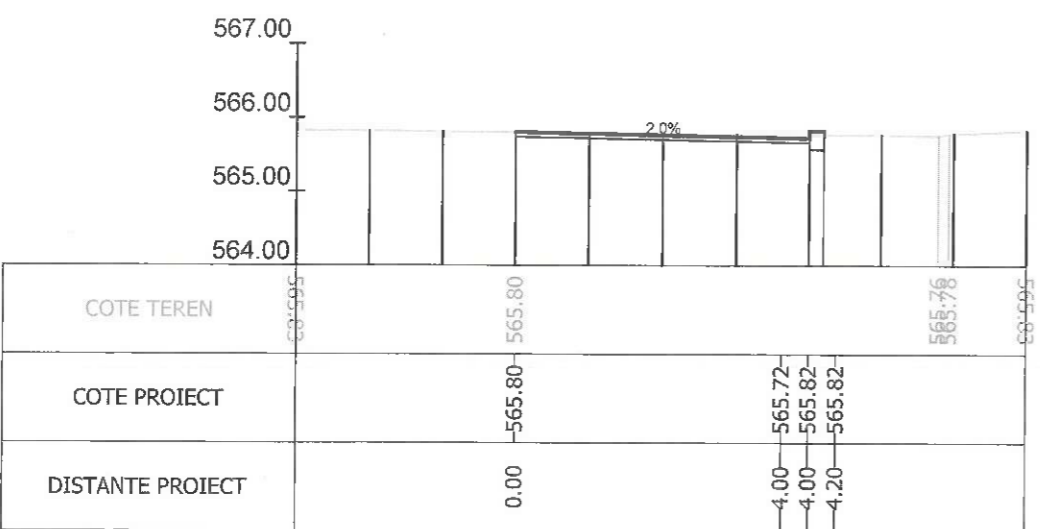

Sectiunea 241 - Km 3+300
Ax-Traseul 1

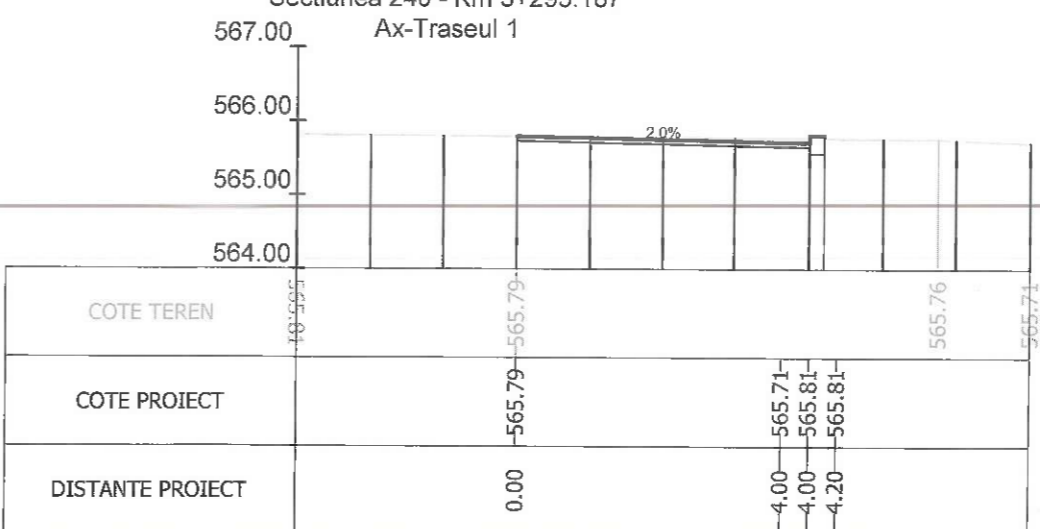

Sectiunea 242 - Km 3+308.358
Ax-Traseul 1

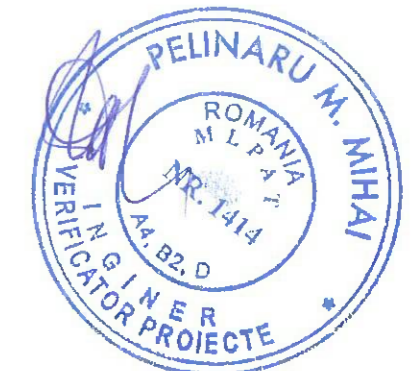

Index	A		Rev. 5
			Beneficiar:
www.hentza.ro <small>REG. PUBLICITARIILOR NR. 17 BUCURESTI NR. 2 STRADA 4 VOLUNTARII BUCURESTI, TEL. +40 0734 04 6449, EMAIL OFFICE@HENTZA.RO</small>			MUNICIPIUL BRASOV Bulevardul Eroilor 8, Brasov 500007
Sef Proiect	Ing. A. Buta	Scara 1/100	Nr. proiect 73 / 2020
Proiectat	Ing. A. Buta		Faza P.T.
Desenat	Ing. S. Patroi	Data 07/2023	Tytu proiect: AMENAJARE BENZI DEDICATE TRANSPORTULUI PUBLIC IN MUNICIPIUL BRASOV SI TROTUARE ADIACENTE
Verificat			Tytu plansa: PROFILE TRANSVERSALE CURENTE
			Nr. plansa PT-35

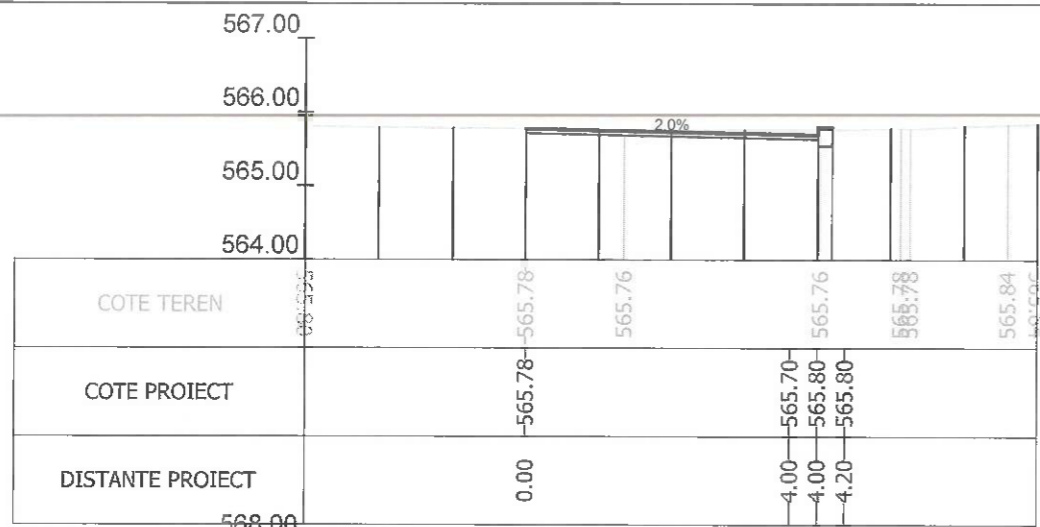

Sectiunea 243 - Km 3+321.530
Ax-Traseul 1

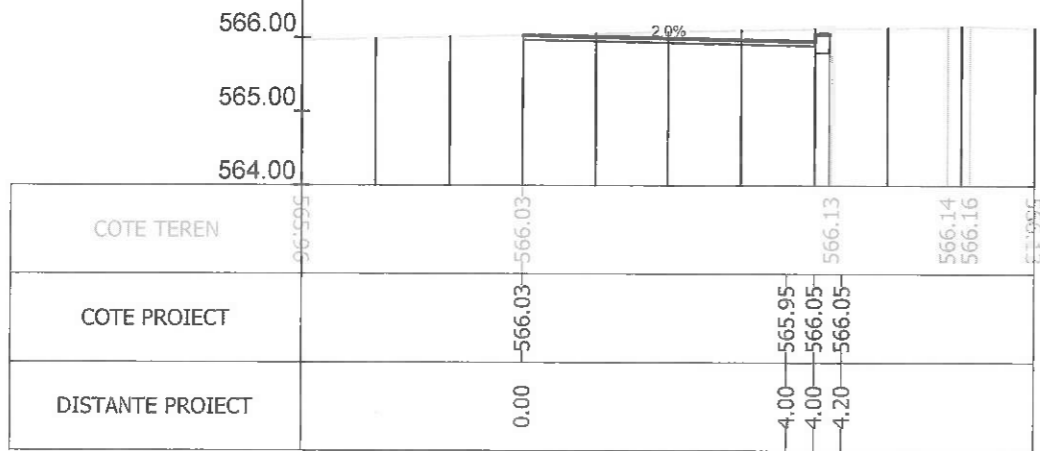

Sectiunea 245 - Km 3+346.491
Ax-Traseul 1

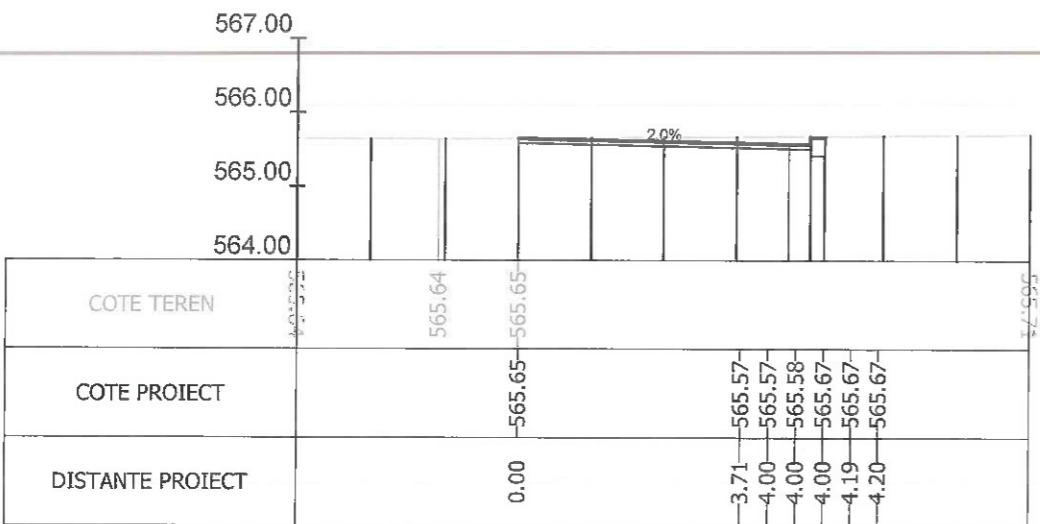

Sectiunea 247 - Km 3+375
Ax-Traseul 1

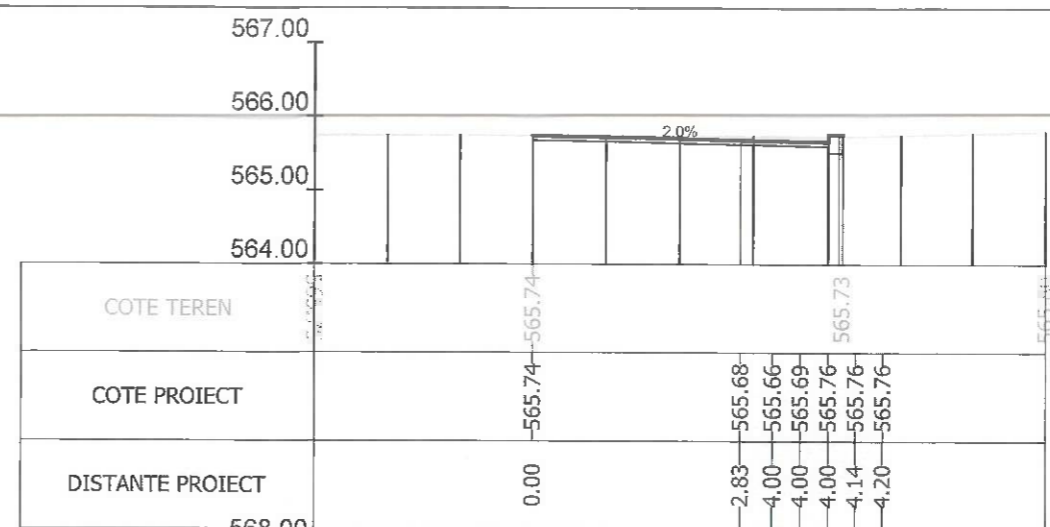

Sectiunea 244 - Km 3+325
Ax-Traseul 1

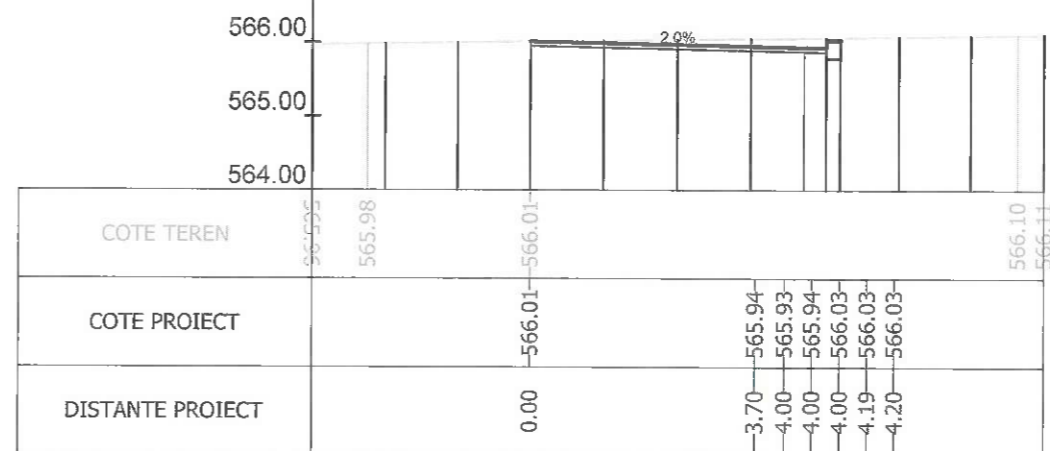

Sectiunea 246 - Km 3+350
Ax-Traseul 1



Sectiunea 248 - Km 3+400
Ax-Traseul 1

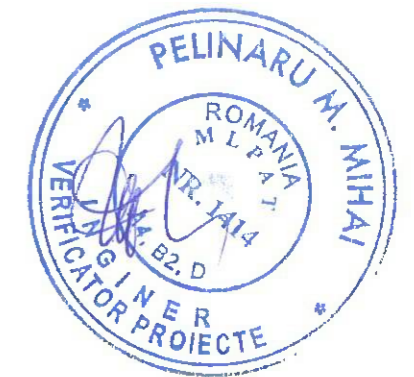

Index	A		Rev. 5
			Beneficiar: MUNICIPIUL BRASOV Bulevardul Eroilor 8, Brasov 500007
Sef Proiect	Ing. A. Buta		Nr. proiect: 73 / 2020
Proiectat	Ing. A. Buta		Faza P.T.
Desenat	Ing. S. Patroi		Titlu plansa: PROFILE TRANSVERSALE CURENTE
Verificat			Nr. plansa: PT-36
Scara 1/100			
Data 07/2023			

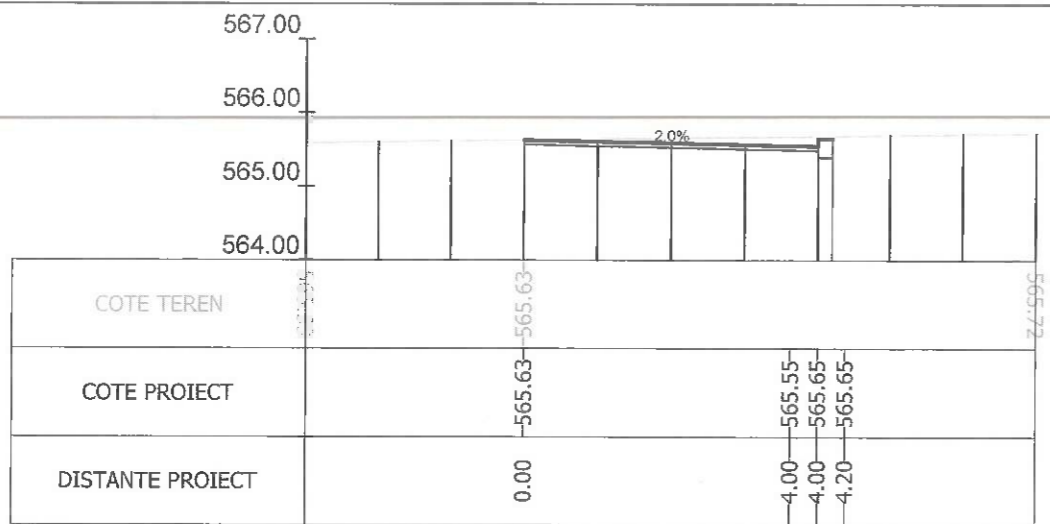

Sectiunea 249 - Km 3+421.270
Ax-Traseul 1

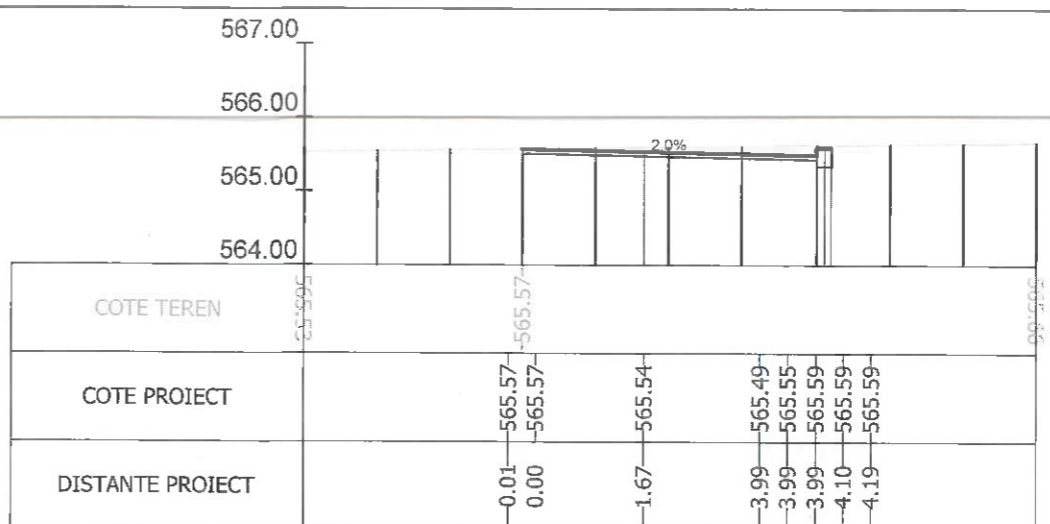

Sectiunea 250 - Km 3+425
Ax-Traseul 1

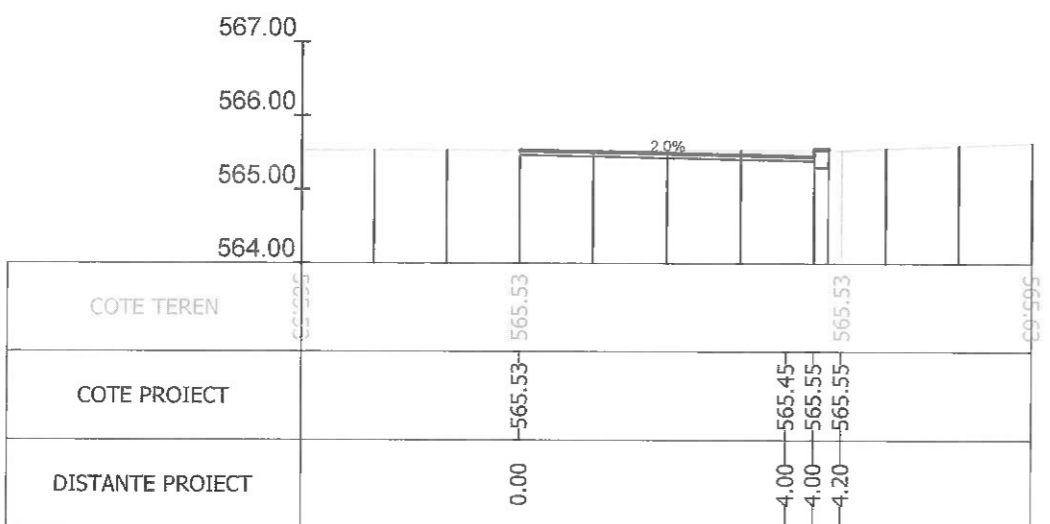

Sectiunea 251 - Km 3+450
Ax-Traseul 1

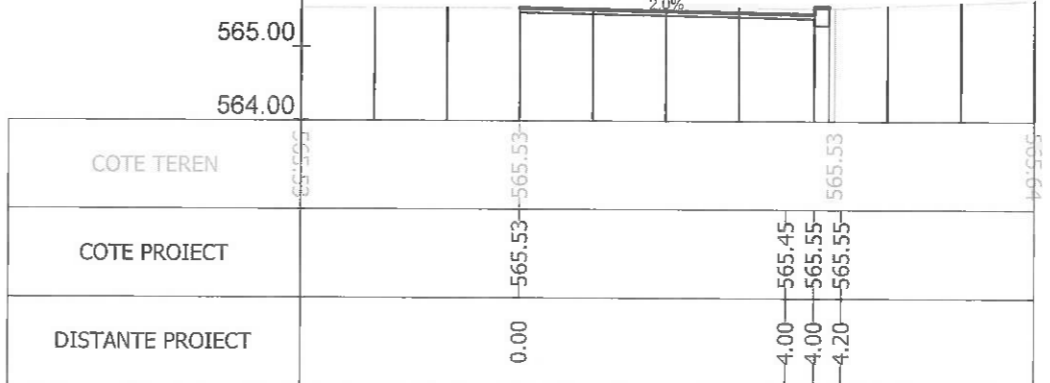

Sectiunea 252 - Km 3+451.266
Ax-Traseul 1

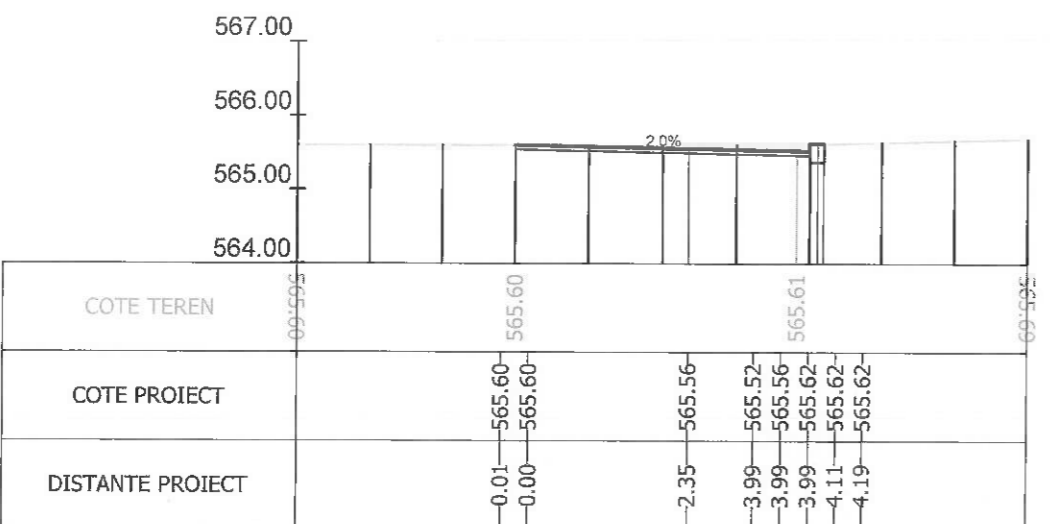

Sectiunea 253 - Km 3+475
Ax-Traseul 1

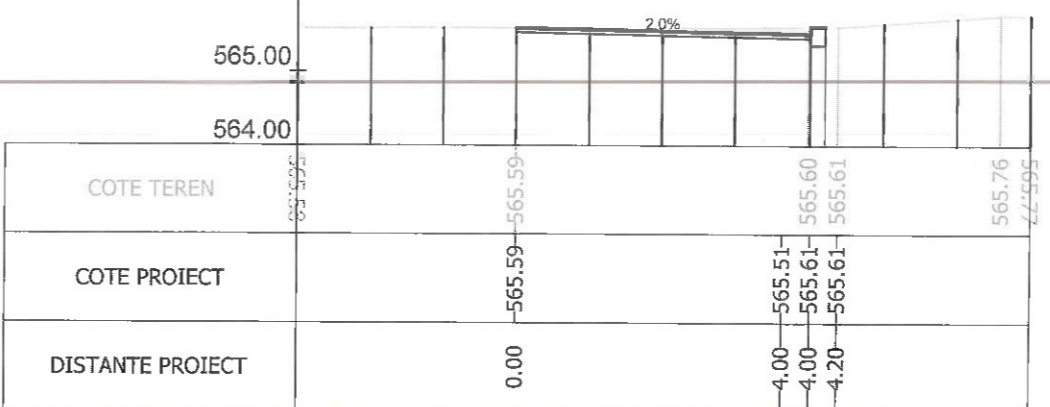

Sectiunea 254 - Km 3+481.262
Ax-Traseul 1

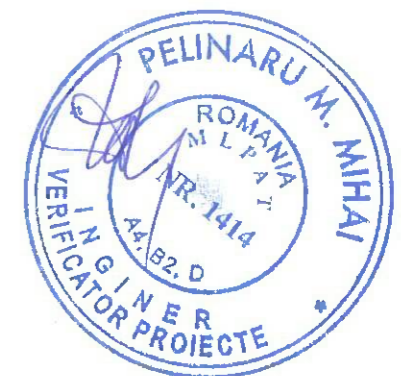

Index	Ax-Traseul 1		Rev. 5
A			
 www.hentza.ro		Beneficiar:	MUNICIPIUL BRASOV Bulevardul Eroilor 8, Brasov 500007
		Nr. proiect	73 / 2020
Sef Proiect	Ing. A. Buta		Titlu proiect:
Proiectat	Ing. A. Buta		
Desenat	Ing. S. Patroi		Faza
Verificat			P.T.
Scara		1/100	Titlu plansa:
Data		07/2023	
			Nr. plansa
			PT-37

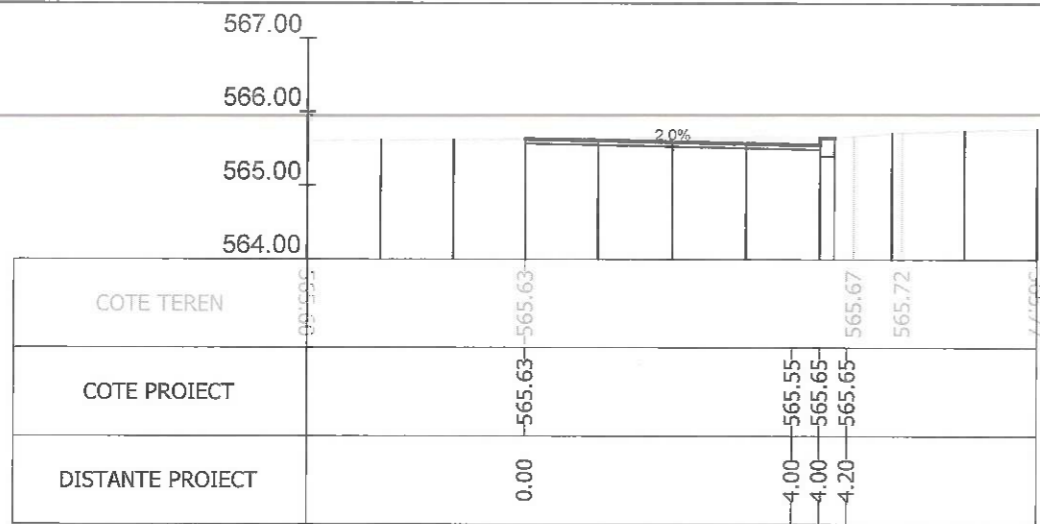

Sectiunea 255 - Km 3+484.302
Ax-Traseul 1

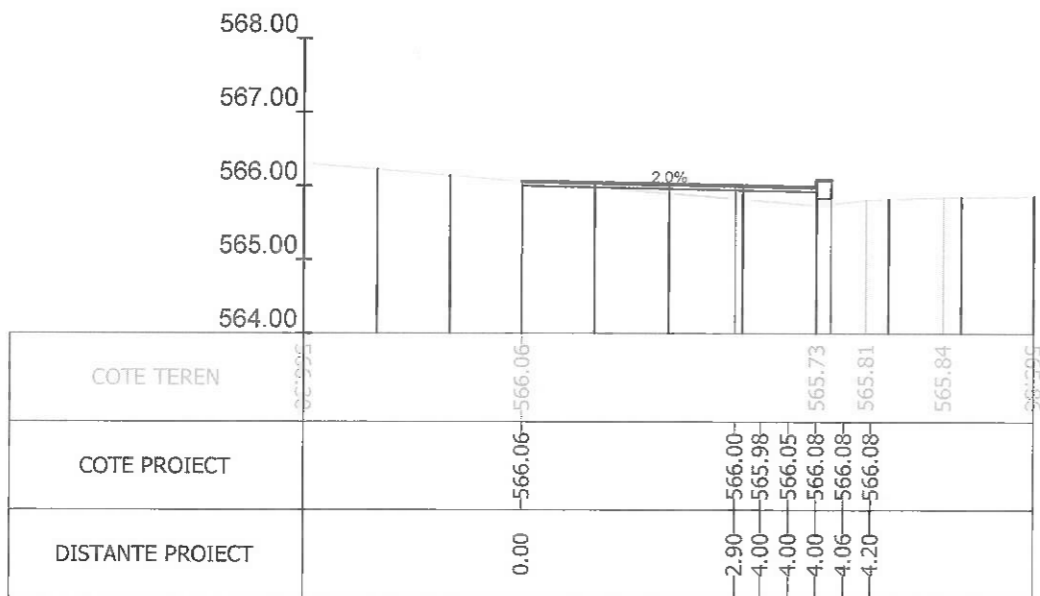

Sectiunea 257 - Km 3+525
Ax-Traseul 1

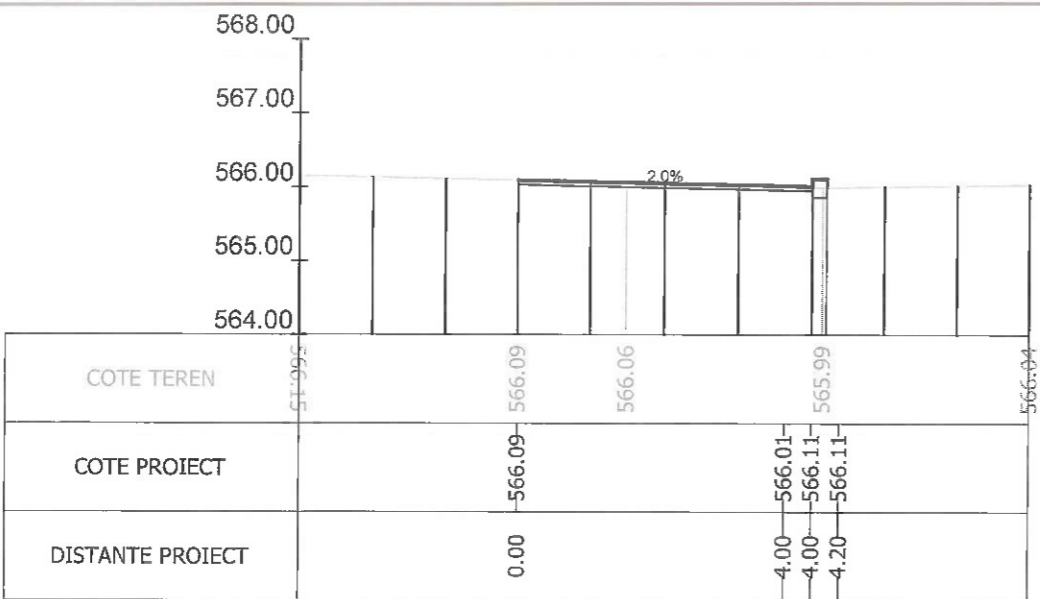

Sectiunea 260 - Km 3+567.349
Ax-Traseul 1

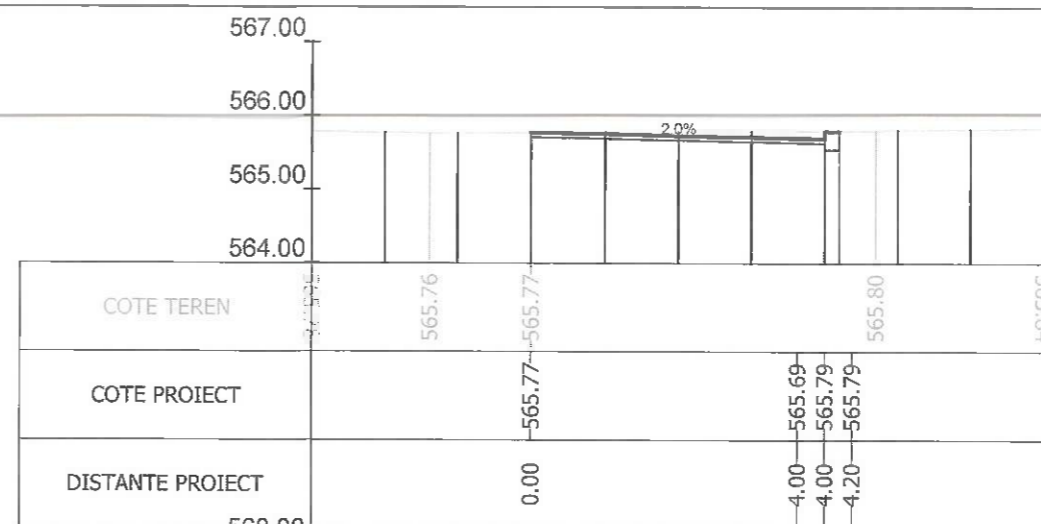

Sectiunea 256 - Km 3+500
Ax-Traseul 1

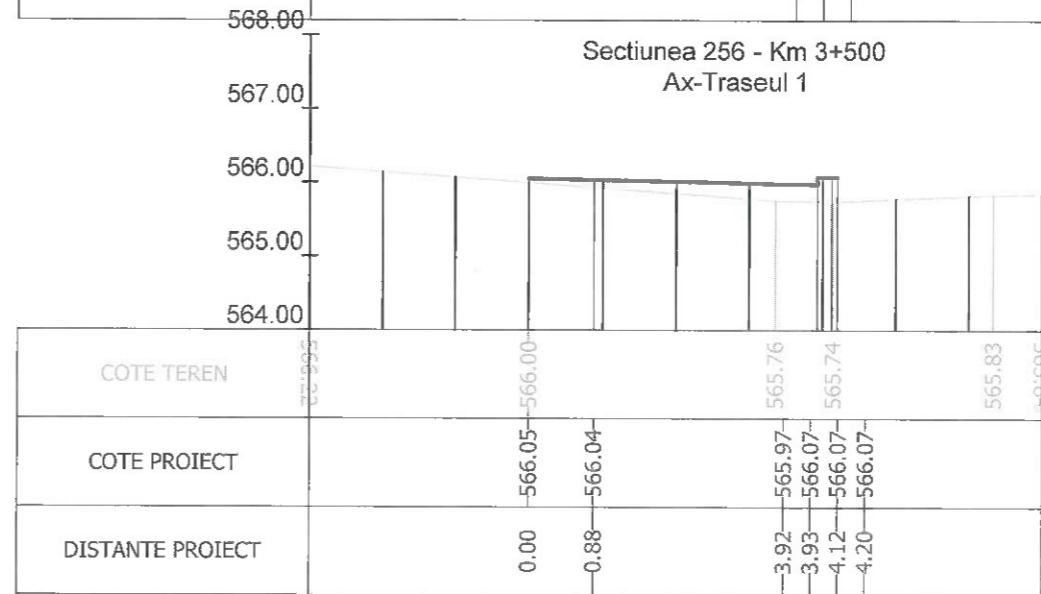

Sectiunea 258 - Km 3+527.620
Ax-Traseul 1

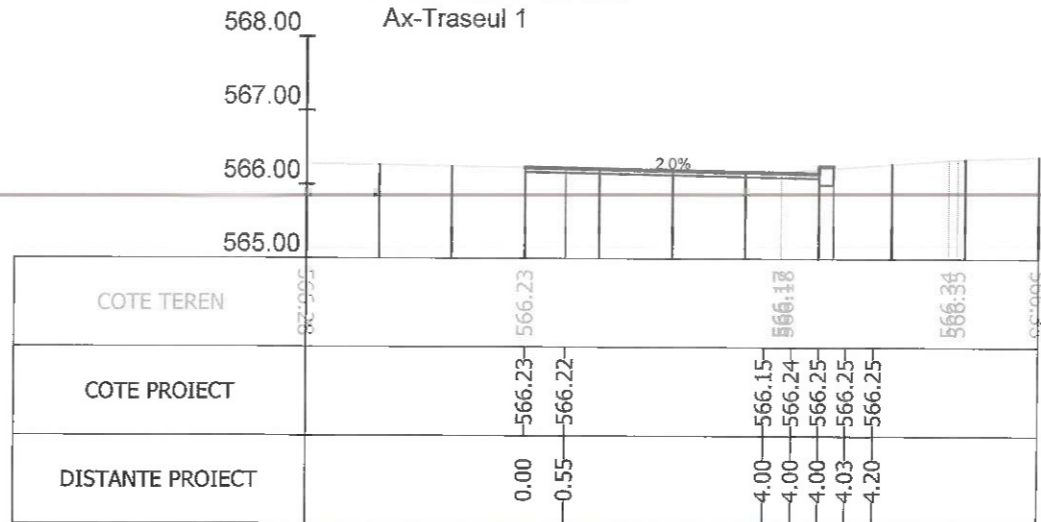

Sectiunea 261 - Km 3+575
Ax-Traseul 1

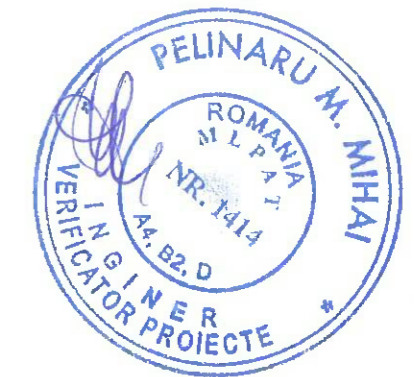

Index	Data	Observatii	Rev. 5
A			
		Beneficiar:	MUNICIPIUL BRASOV Bulevardul Eroilor 8, Brasov 500007
Sef Proiect: Ing. A. Buta Proiectat: Ing. A. Buta Desenat: Ing. S. Patroi Verificat:		Titlu proiect:	AMENAJARE BENZI DEDICATE TRANSPORTULUI PUBLIC IN MUNICIPIUL BRASOV SI TROTUARE ADIACENTE
Scara: 1/100		Titlu plansa:	PROFILE TRANSVERSALE CURENTE
Data: 07/2023		Nr. proiect:	73 / 2020
		Faza:	P.T.
		Nr. plansa:	PT-38

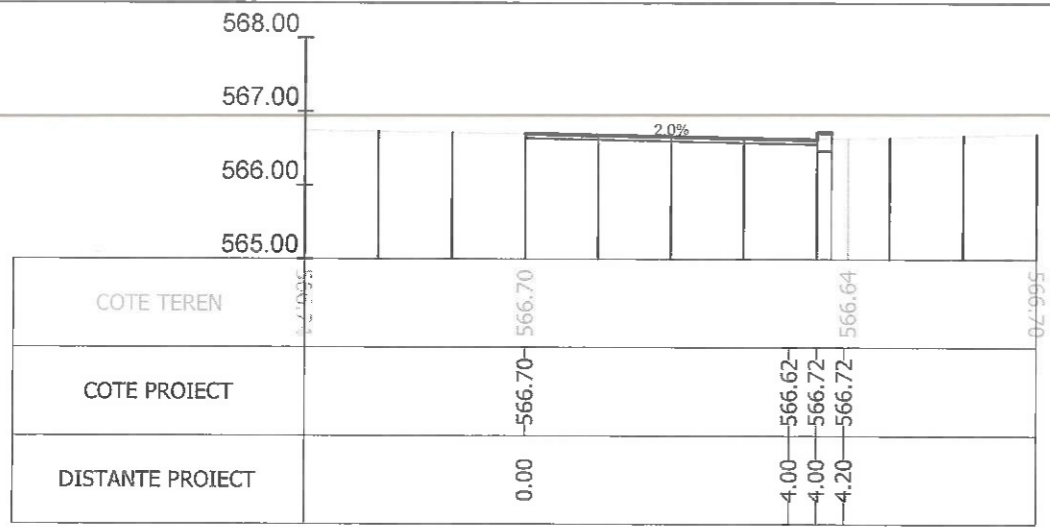

Sectiunea 262 - Km 3+600
Ax-Traseul 1

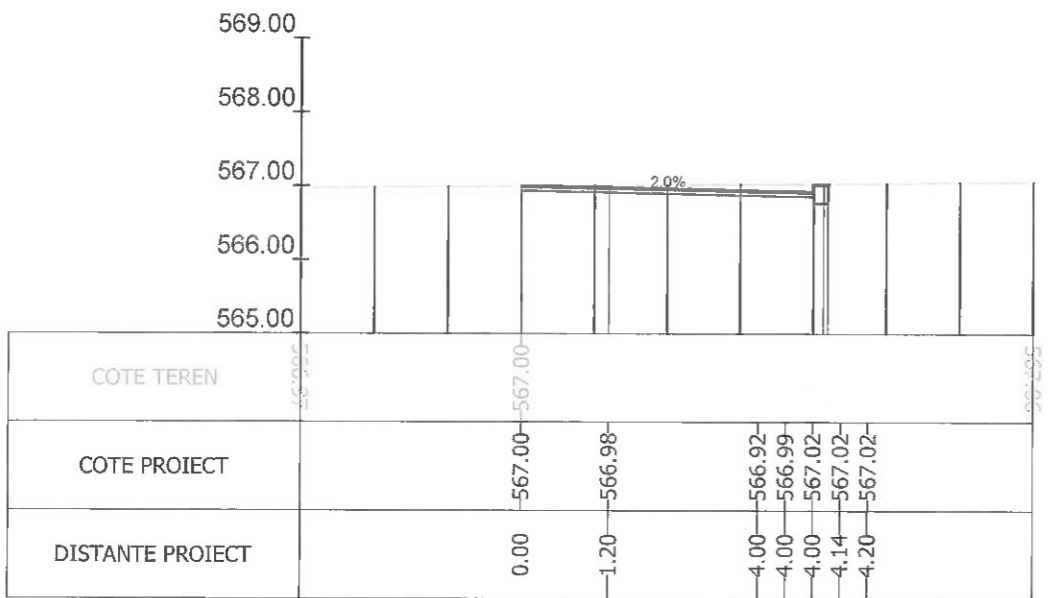

Sectiunea 264 - Km 3+625
Ax-Traseul 1

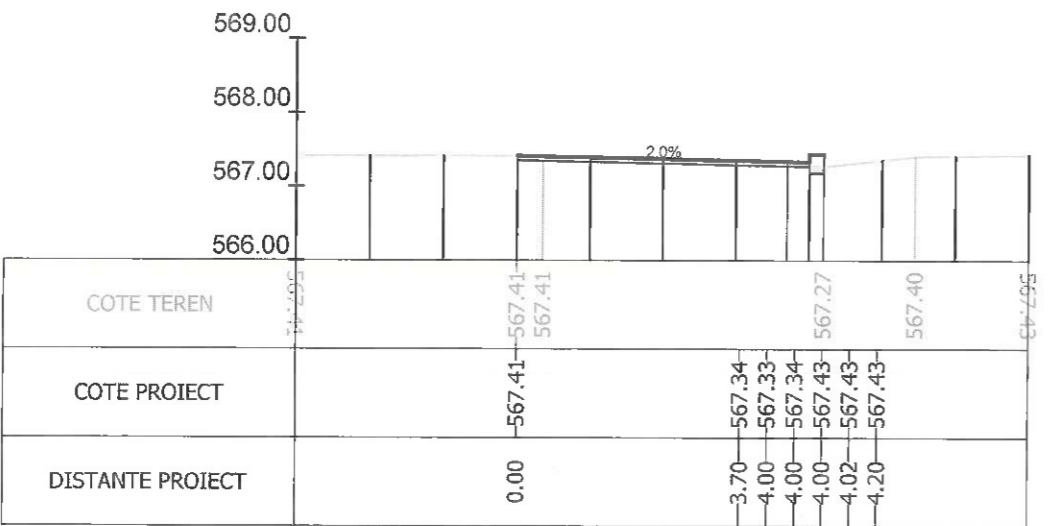

Sectiunea 266 - Km 3+675
Ax-Traseul 1

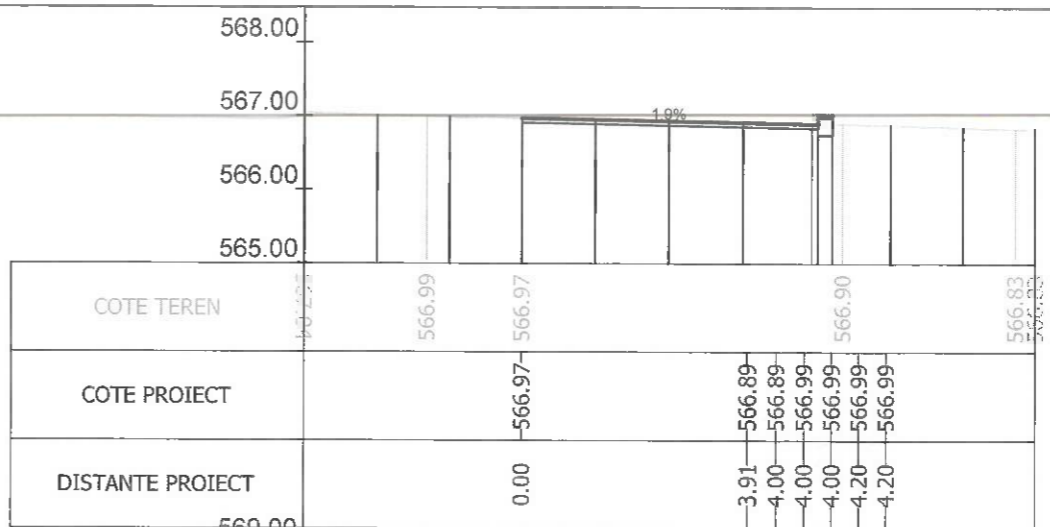

Sectiunea 263 - Km 3+607.563
Ax-Traseul 1

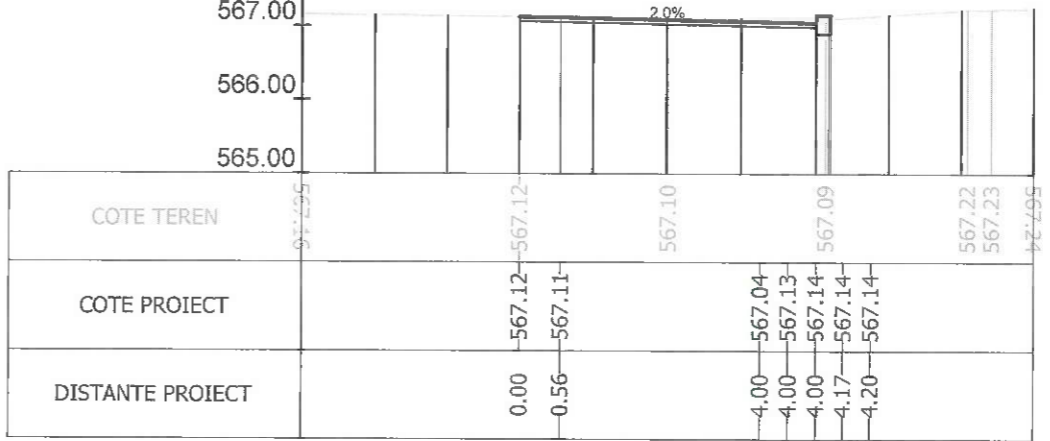

Sectiunea 265 - Km 3+650
Ax-Traseul 1

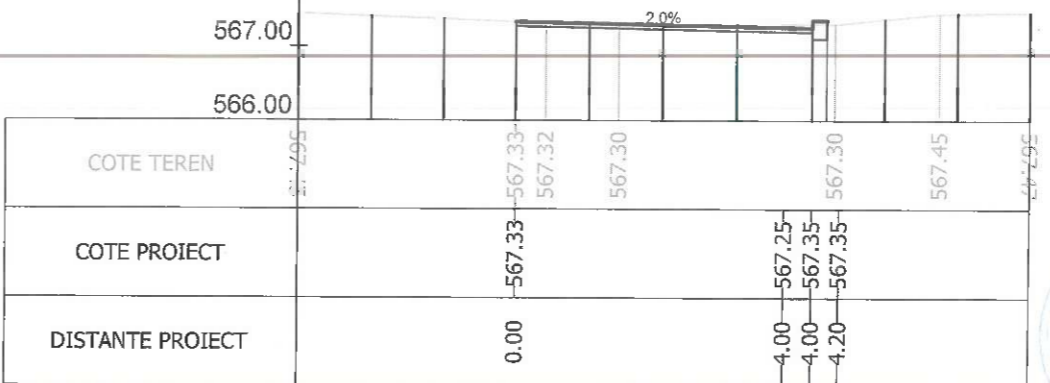

Sectiunea 267 - Km 3+679.003

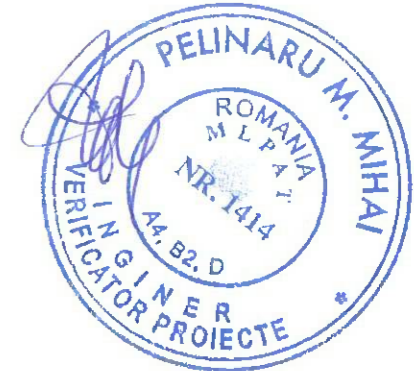

Index	Data		Rev. 5
A			
			Beneficiar:
Sef Proiect: Ing. A. Buta Proiectat: Ing. A. Buta Desenat: Ing. S. Patroi Verificat:			MUNICIPIUL BRASOV Bulevardul Eroilor 8, Brasov 500007
Scara: 1/100 Data: 07/2023			Nr. proiect: 73 / 2020 Faza: P.T. Nr. plansa: PT-39
Titlu proiect: AMENAJARE BENZI DEDICATE TRANSPORTULUI PUBLIC IN MUNICIPIUL BRASOV SI TROTUARE ADIACENTE			Titlu plansa: PROFILE TRANSVERSALE CURENTE

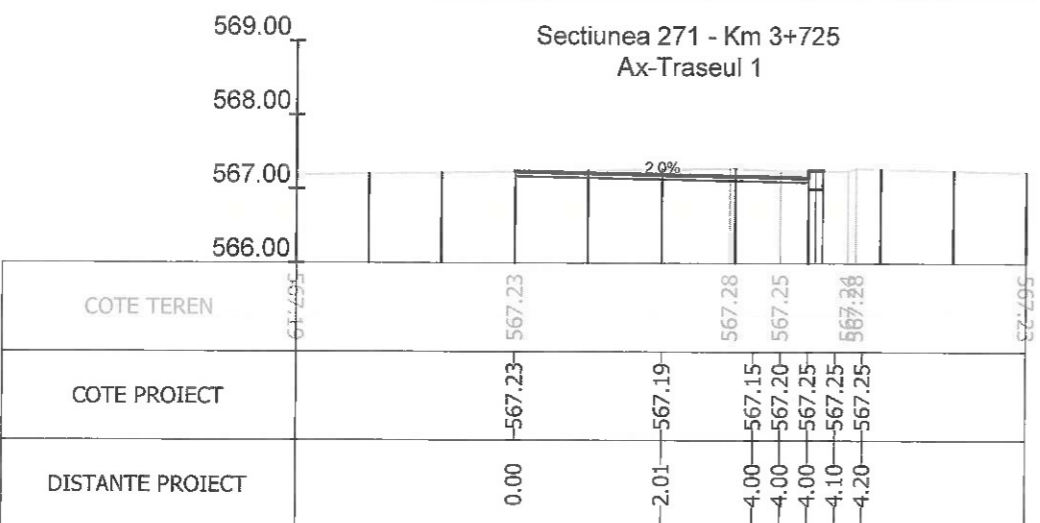
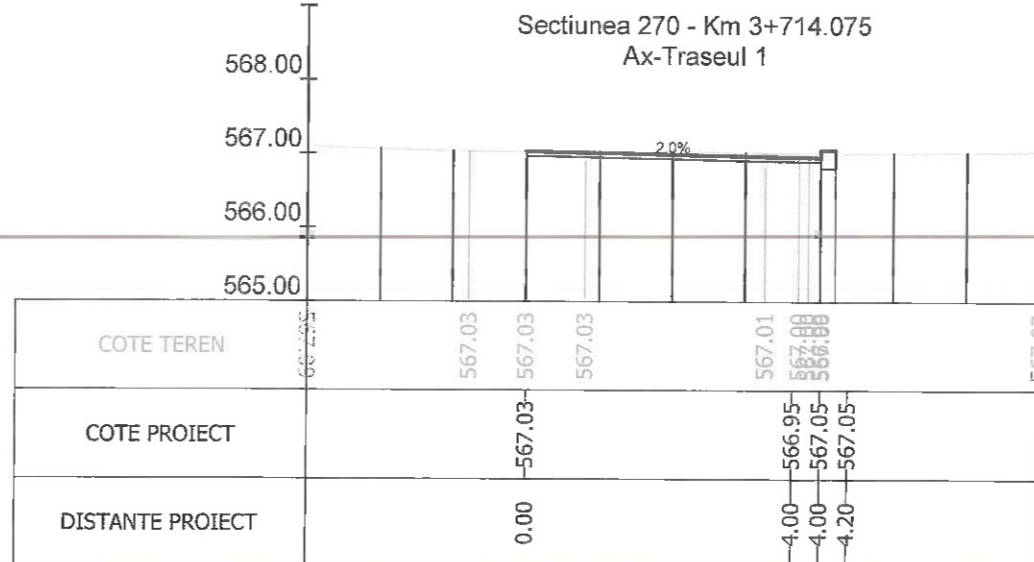
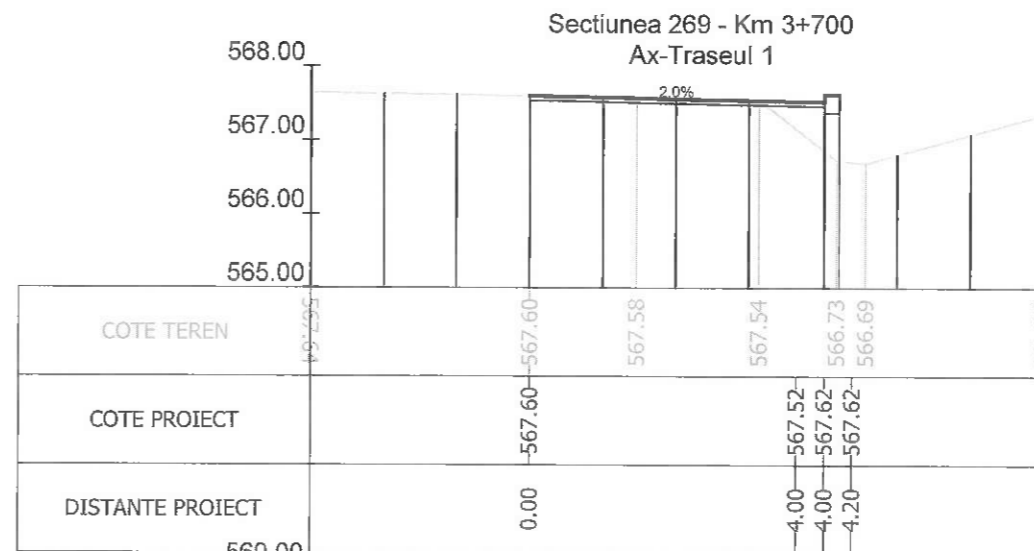
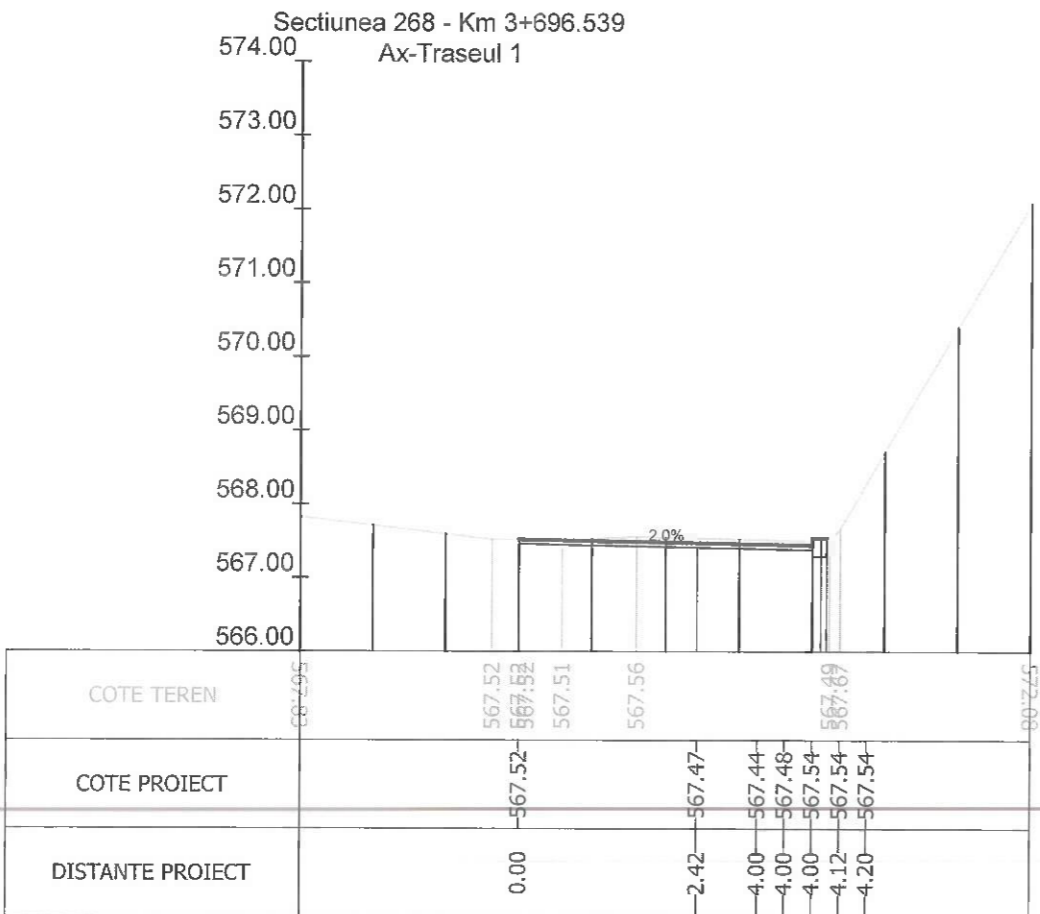
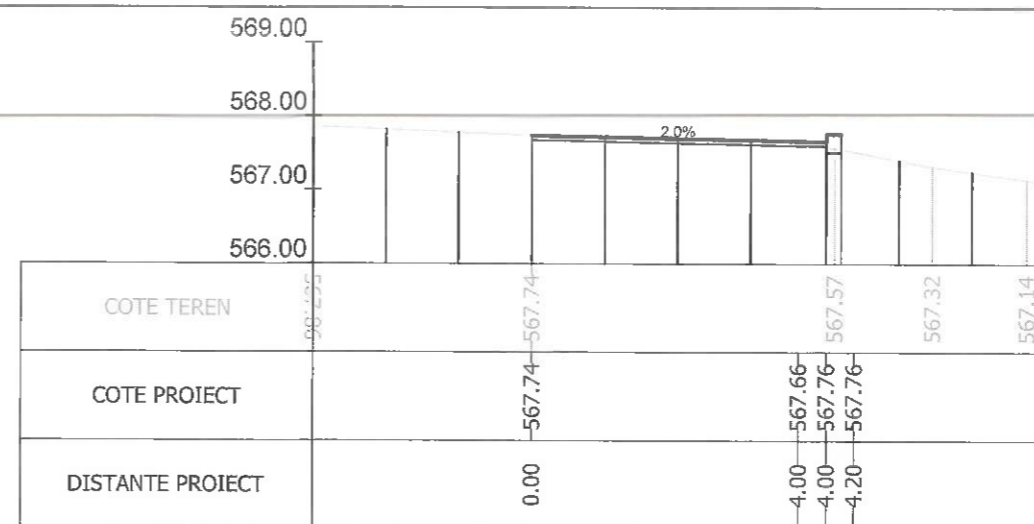
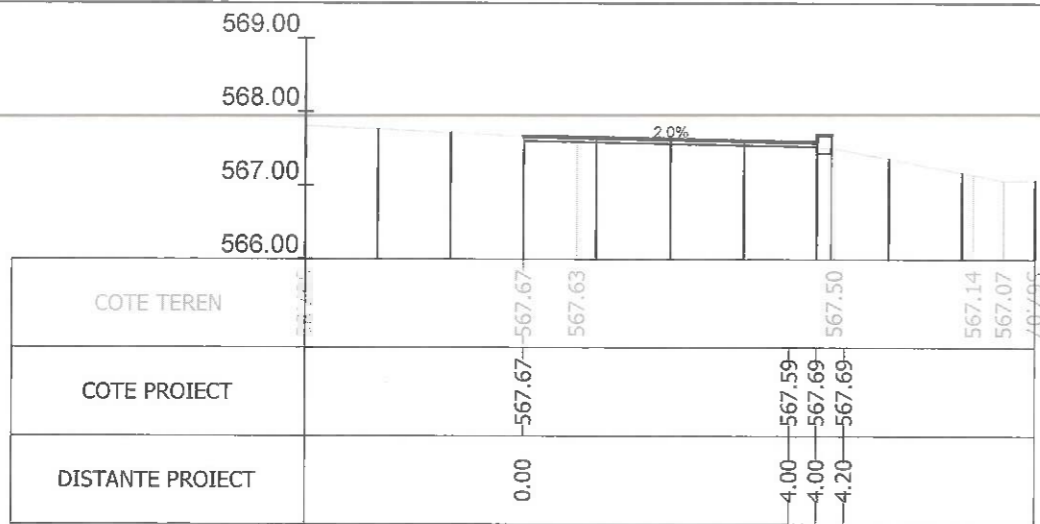

Sectiunea 273 - Km 3+760.528

Index	Det Ax-Traseul		Rev. 5
A			
		Beneficiar:	MUNICIPIUL BRASOV Bulevardul Eroilor 8, Brasov 500007
Sef Proiect: Ing. A. Buta Proiectat: Ing. A. Buta Desenat: Ing. S. Patroi Verificat:		Titlu proiect:	AMENAJARE BENZI DEDICATE TRANSPORTULUI PUBLIC IN MUNICIPIUL BRASOV SI TROTUARE ADJACENTE
Scara: 1/100		Titlu plansa:	PROFILI TRANSVERSALE CURENTE
Data: 07/2023		Nr. proiect:	73 / 2020
		Nr. plansa:	PT-40

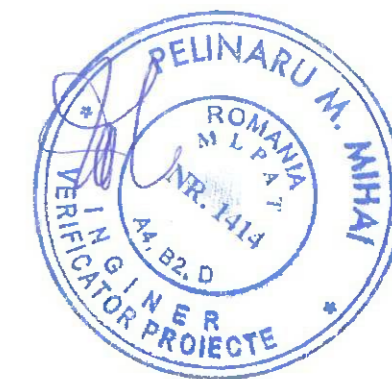

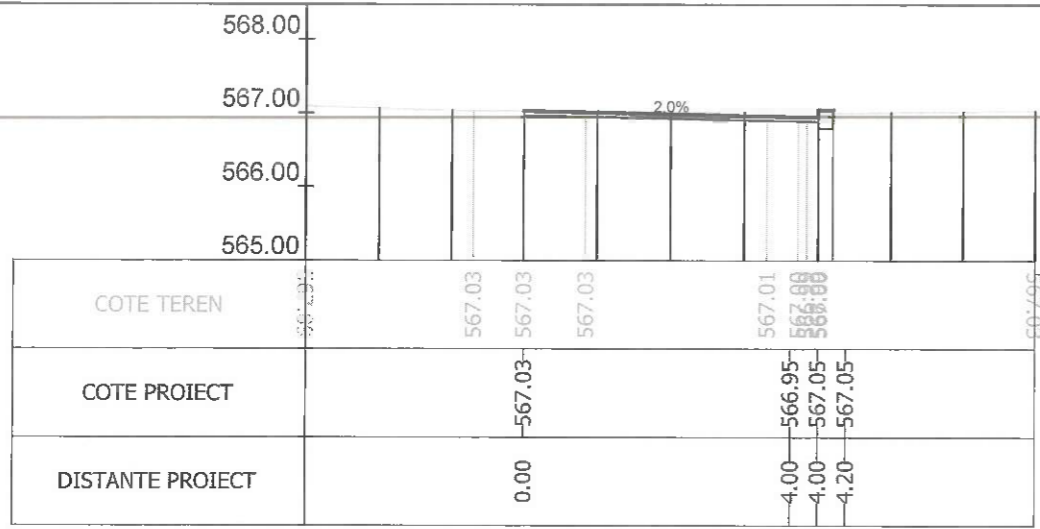

Sectiunea 274 - Km 3+760.591
Ax-Traseul 1

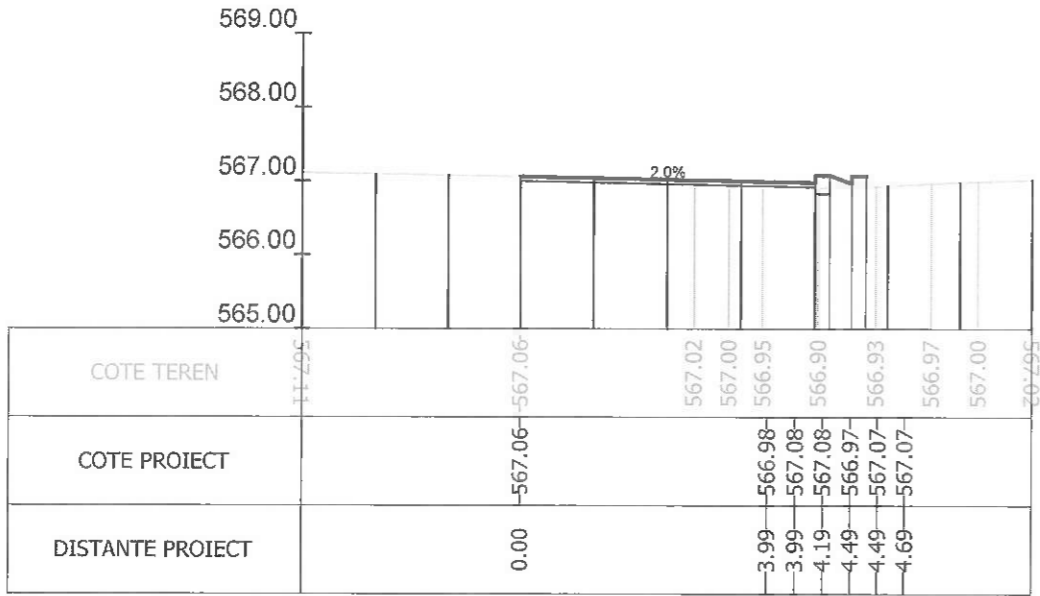

Sectiunea 276 - Km 3+773.896
Ax-Traseul 1

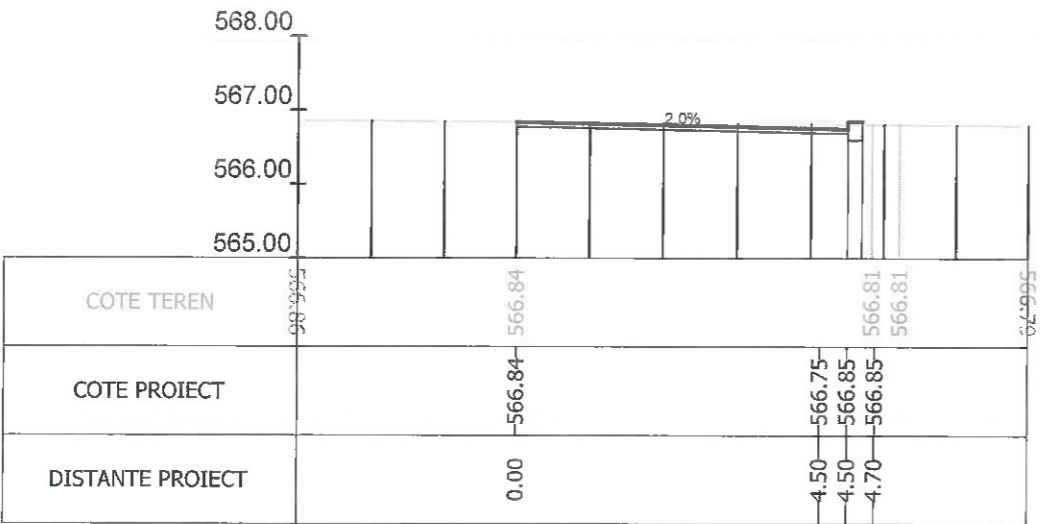

Sectiunea 278 - Km 3+800
Ax-Traseul 1

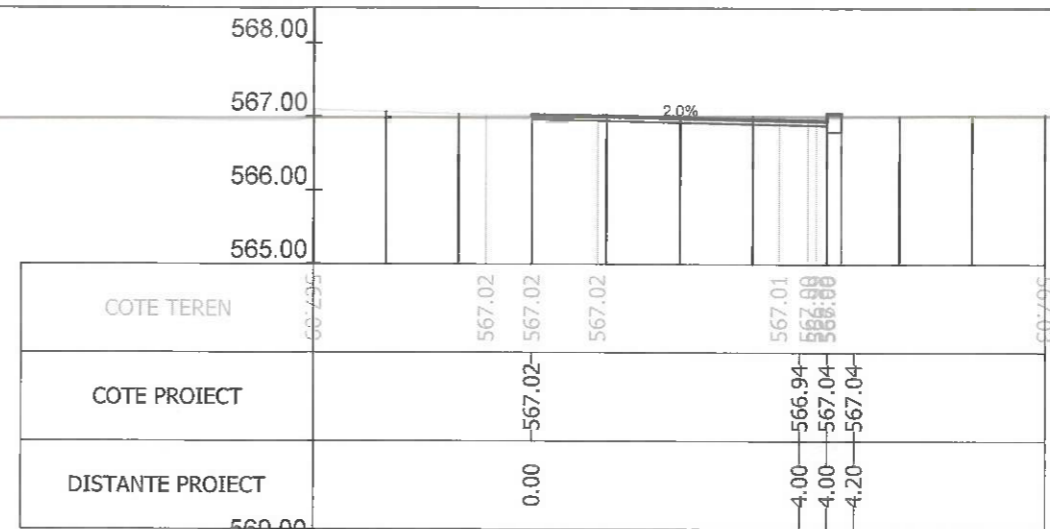

Sectiunea 275 - Km 3+760.653
Ax-Traseul 1

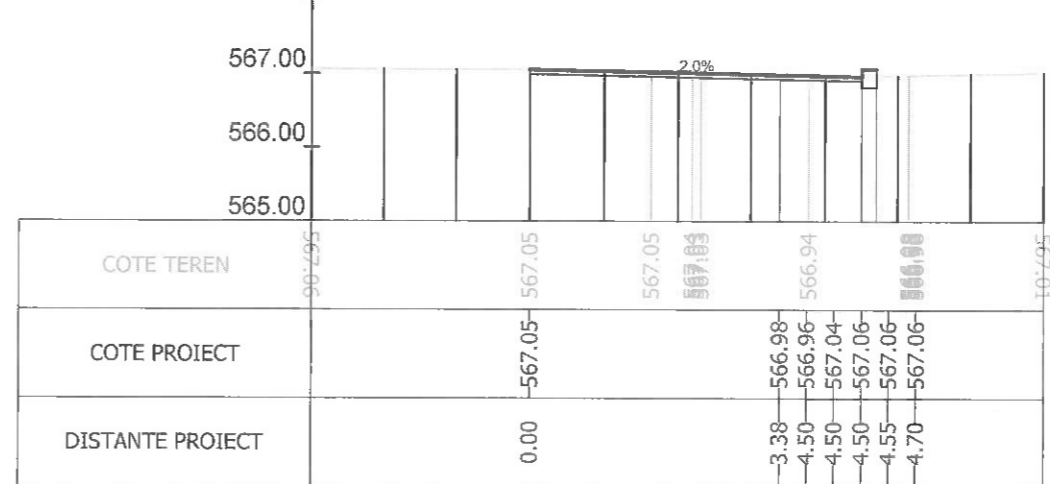

Sectiunea 277 - Km 3+775
Ax-Traseul 1

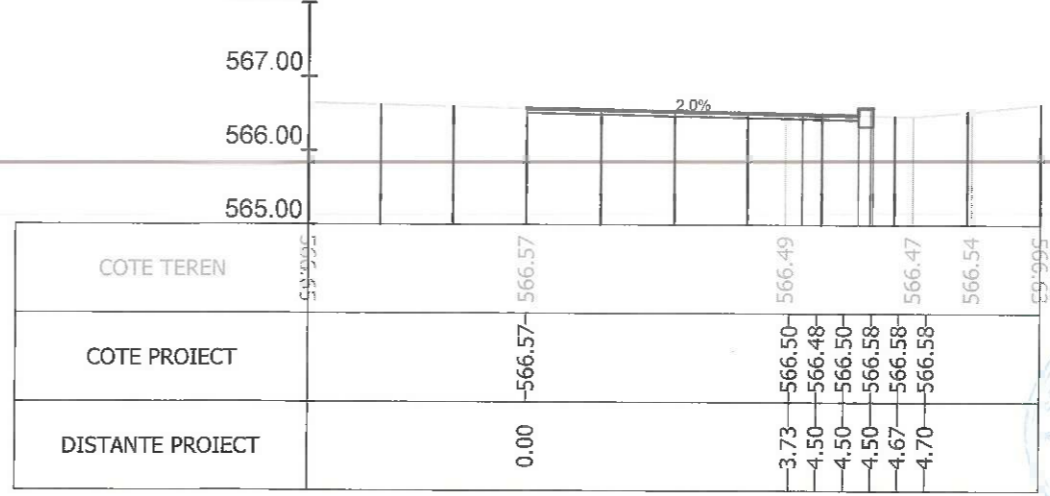

Sectiunea 279 - Km 3+825
Ax-Traseul 1



Index	A		Rev. 5
			Beneficiar: MUNICIPIUL BRASOV Bulevardul Eroilor 8, Brasov 500007
Sef Proiect	Ing. A. Buta	Scara	Nr. proiect
Proiectat	Ing. A. Buta	1/100	73 / 2020
Desenat	Ing. S. Patroi	Data	Faza
Verificat		07/2023	P.T.
Titlu proiect: AMENAJARE BENZI DEDICATE TRANSPORTULUI PUBLIC IN MUNICIPIUL BRASOV SI TROTUARE ADIACENTE			Nr. plansa
Titlu plansa: PROFILE TRANSVERSALE CURENTE			PT-41

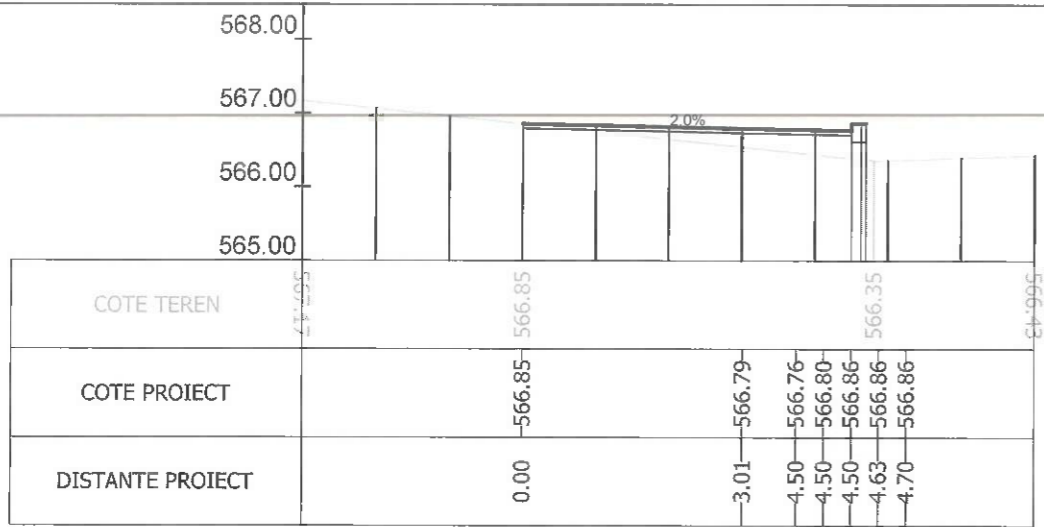

Sectiunea 280 - Km 3+850
Ax-Traseul 1

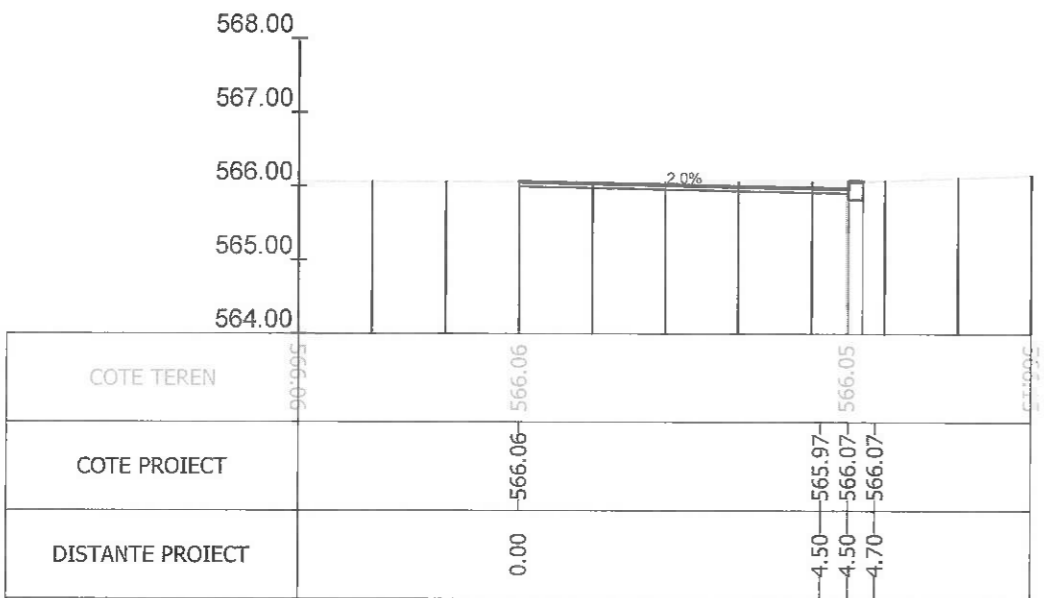

Sectiunea 282 - Km 3+900
Ax-Traseul 1

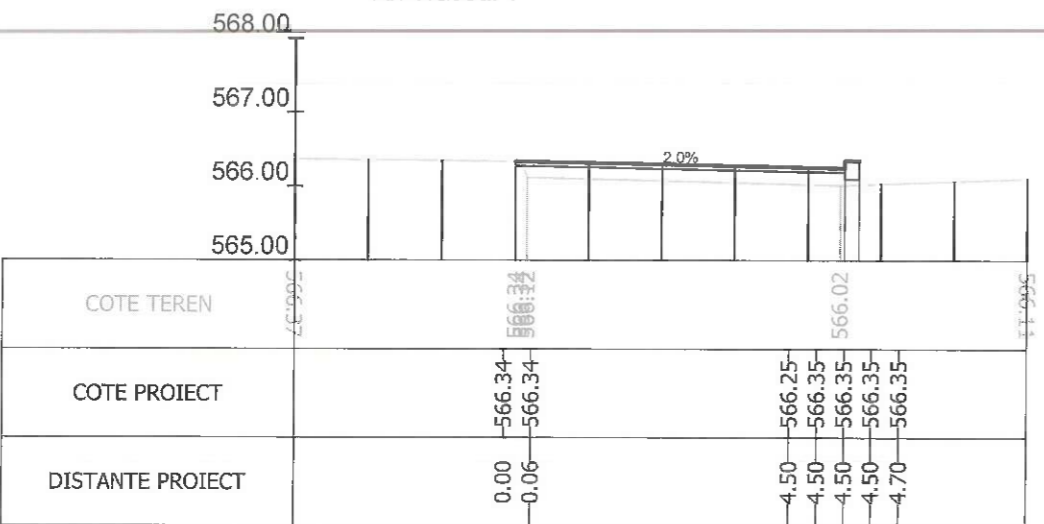

Sectiunea 284 - Km 3+925
Ax-Traseul 1

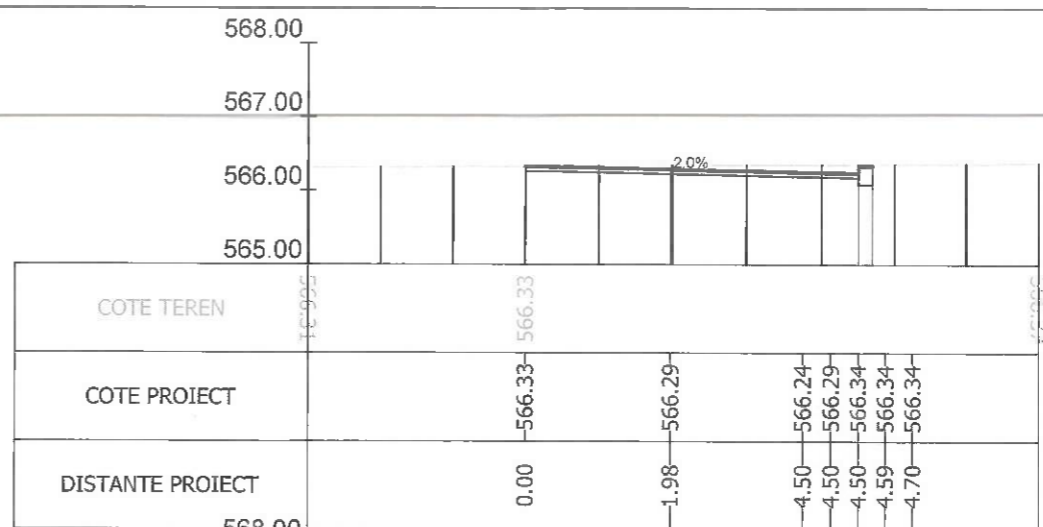

Sectiunea 281 - Km 3+875
Ax-Traseul 1

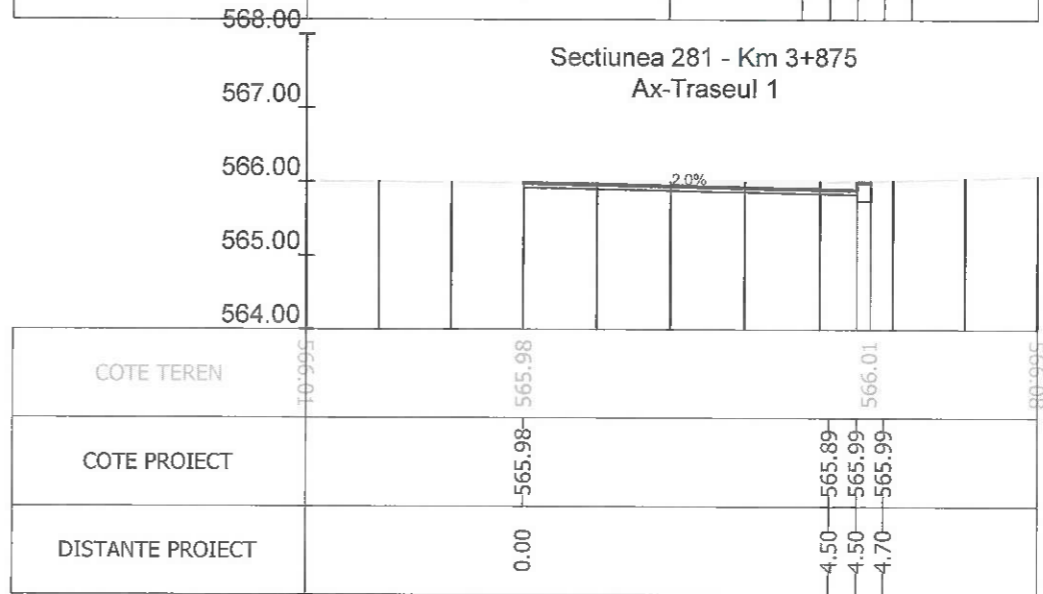

Sectiunea 283 - Km 3+917.711
Ax-Traseul 1

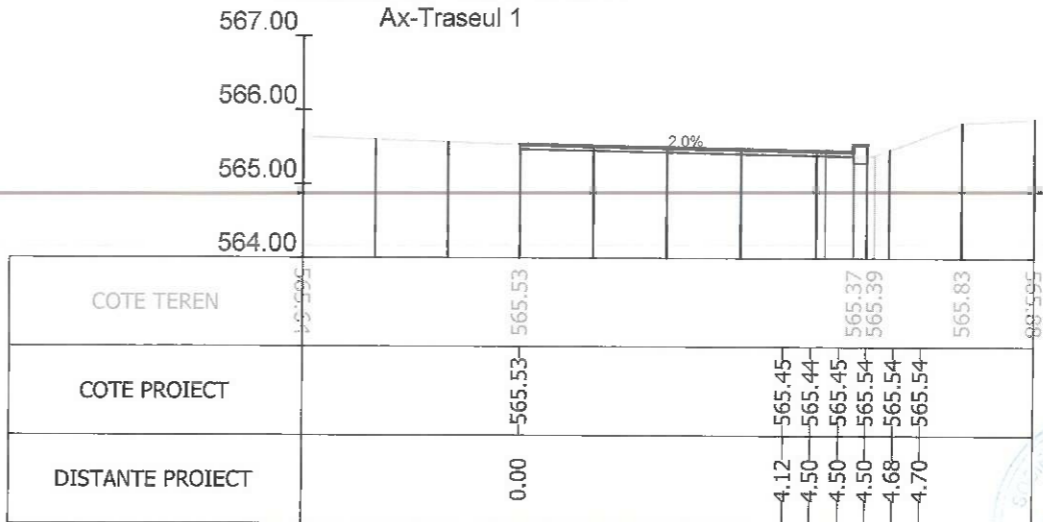

Sectiunea 285 - Km 3+950
Ax-Traseul 1

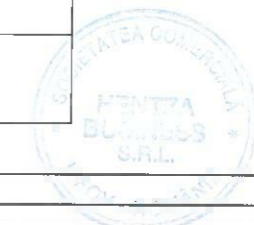

Index	A	Data	07/2023	Rev. 5
		Beneficiar: MUNICIPIUL BRASOV Bulevardul Eroilor 8, Brasov 500007		Nr. proiect 73 / 2020
Sef Proiect Ing. A. Buta Proiectat Ing. A. Buta Desenat Ing. S. Patroi Verificat		Scara 1/100 Data 07/2023		Faza P.T. Nr. plansa PT-42
Titlu proiect: AMENAJARE BENZI DEDICATE TRANSPORTULUI PUBLIC IN MUNICIPIUL BRASOV SI TROTUARE ADIACENTE		Titlu plansa: PROFILE TRANSVERSALE CURENTE		

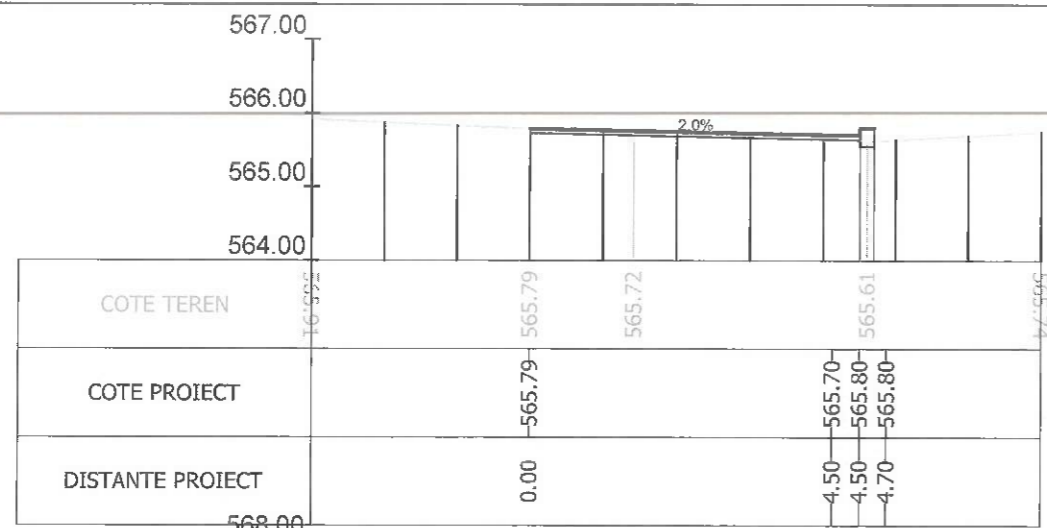

Sectiunea 286 - Km 3+961.401
Ax-Traseul 1

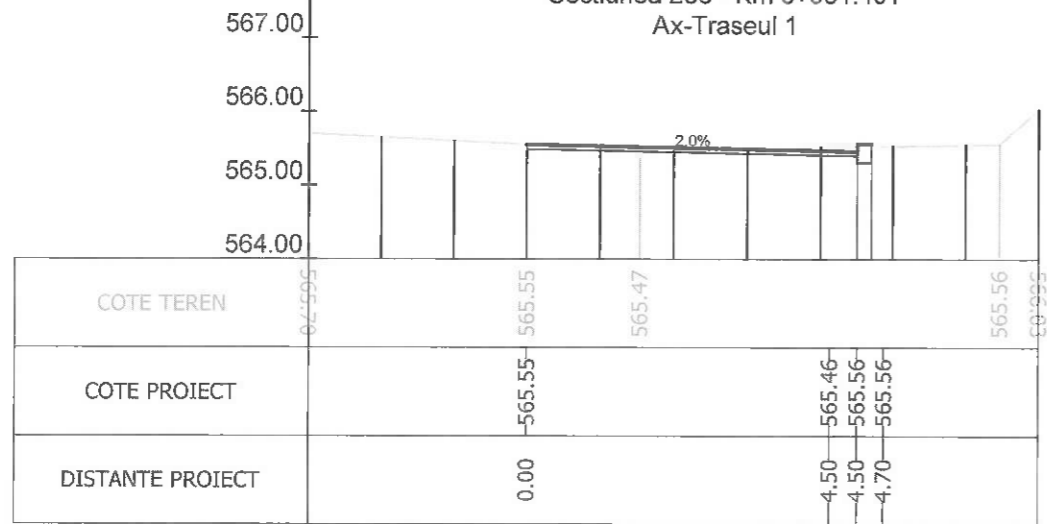

Sectiunea 288 - Km 4+000
Ax-Traseul 1

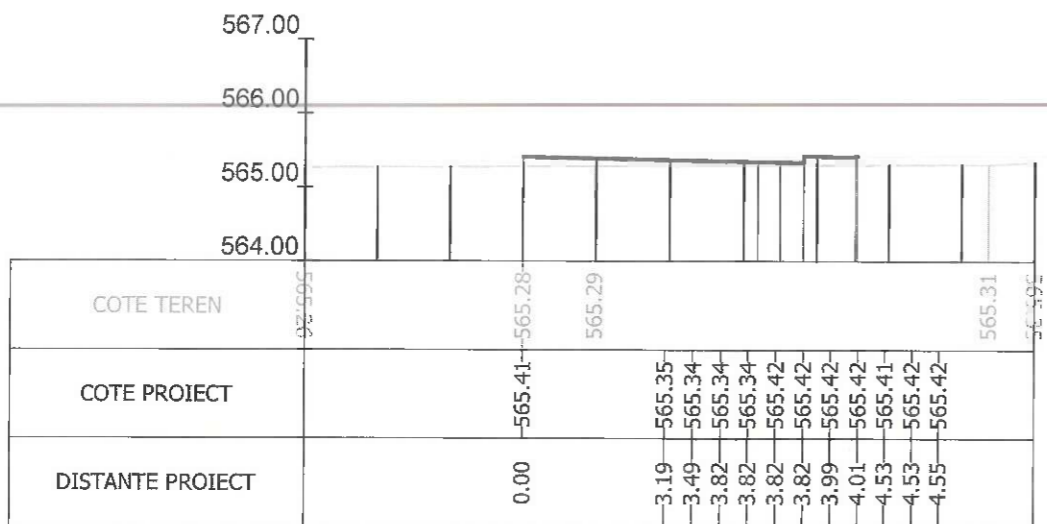

Sectiunea 290 - Km 4+025
Ax-Traseul 1

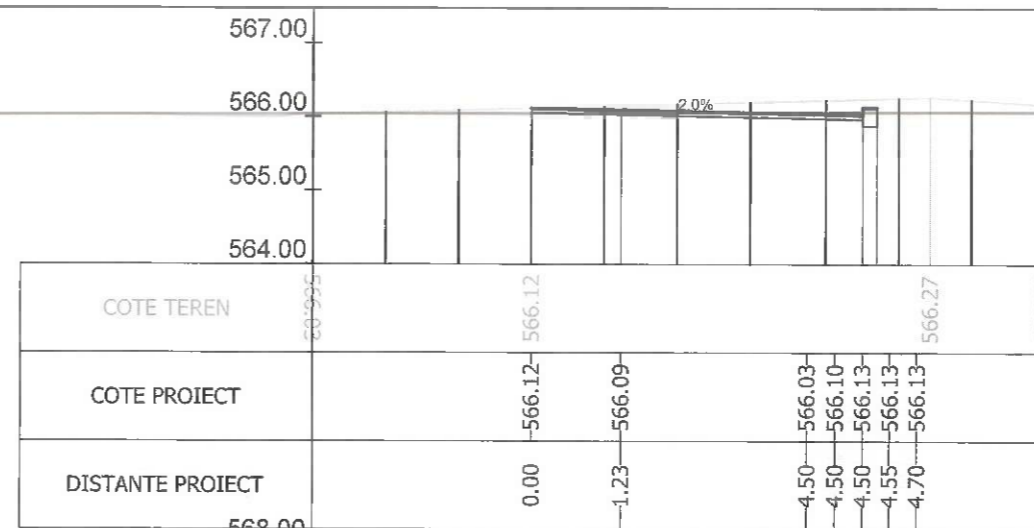

Sectiunea 287 - Km 3+975
Ax-Traseul 1

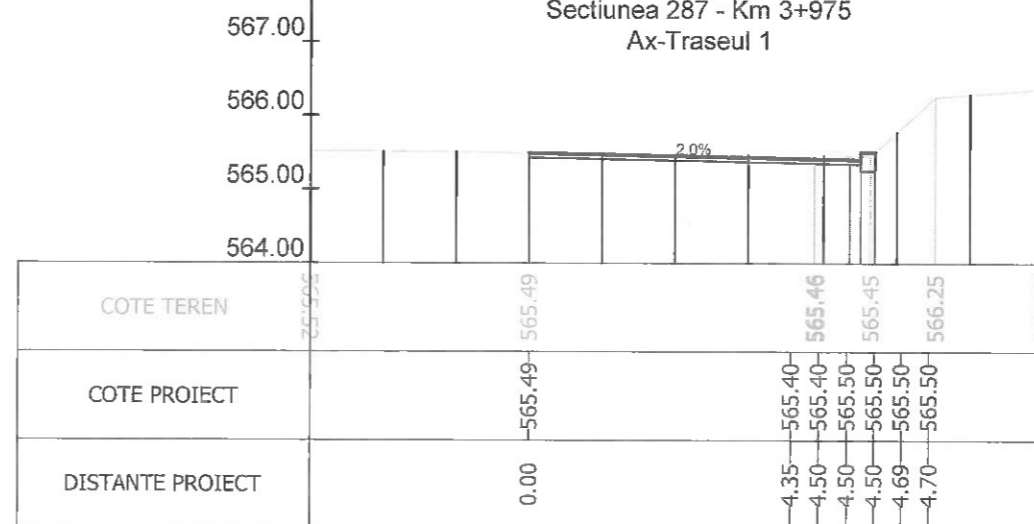

Sectiunea 289 - Km 4+004.441
Ax-Traseul 1

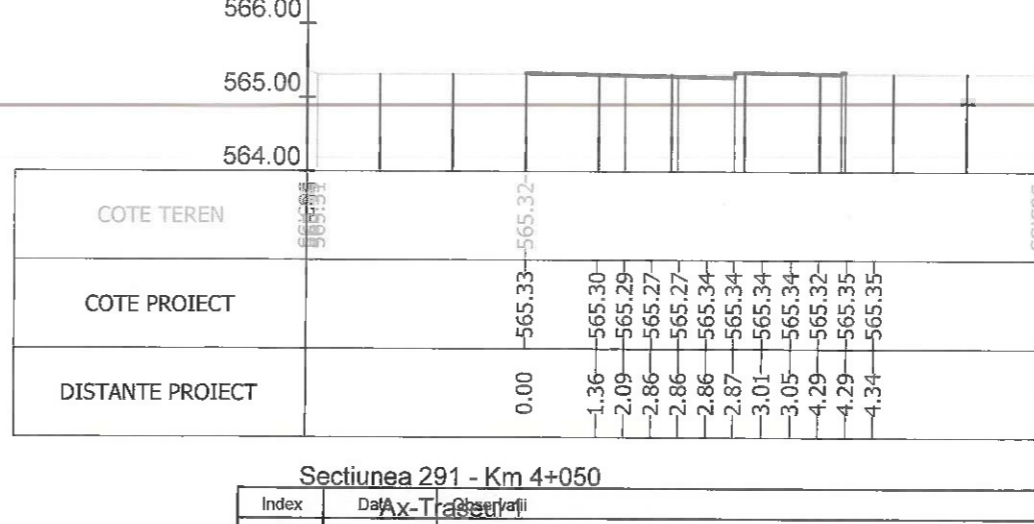

Sectiunea 291 - Km 4+050
Ax-Traseul 1

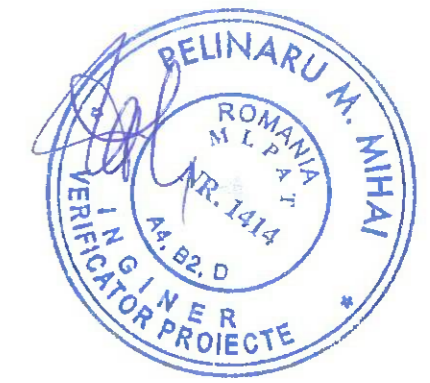

Index	Data	Rev. 5
A		
		Beneficiar: MUNICIPIUL BRASOV Bulevardul Eroilor 8, Brasov 500007
Sef Proiect	Ing. A. Buta	Nr. proiect 73 / 2020
Proiectat	Ing. A. Buta	Faza P.T.
Desenat	Ing. S. Patroi	Tytu planşa: PROFILE TRANSVERSALE CURENTE
Verificat		Nr. planşa PT-43
Scara 1/100		
Data 07/2023		

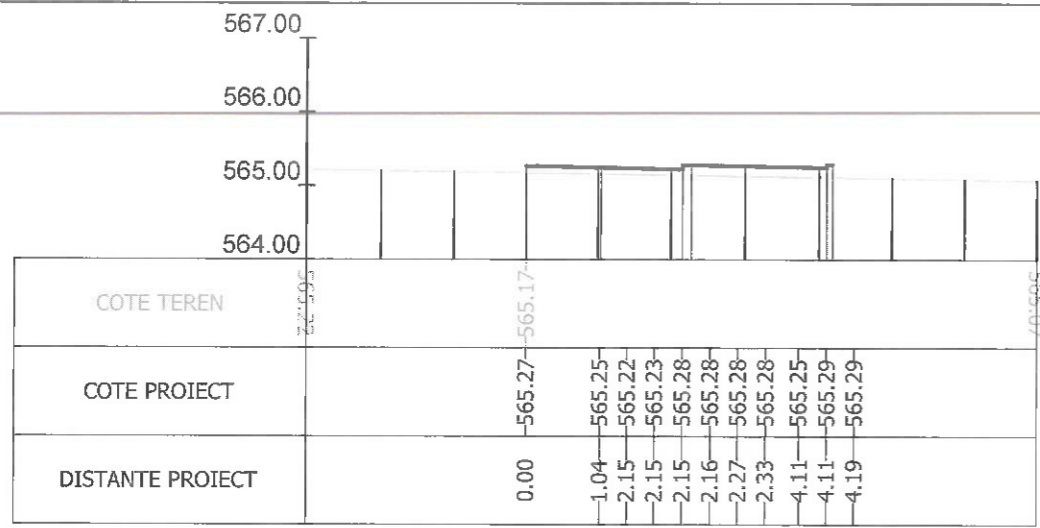

Sectiunea 292 - Km 4+068.619

Ax-Traseul 1

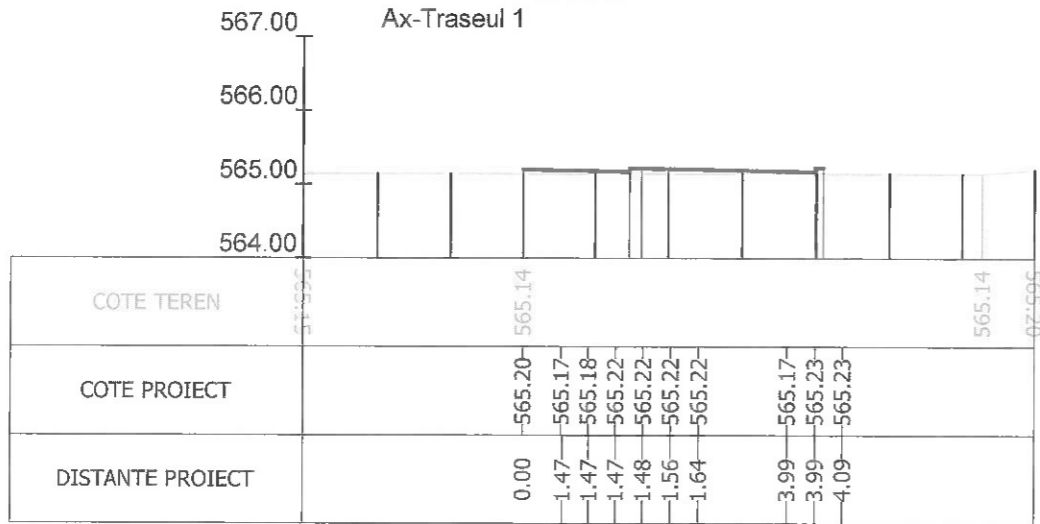

Sectiunea 294 - Km 4+088.360

Ax-Traseul 1

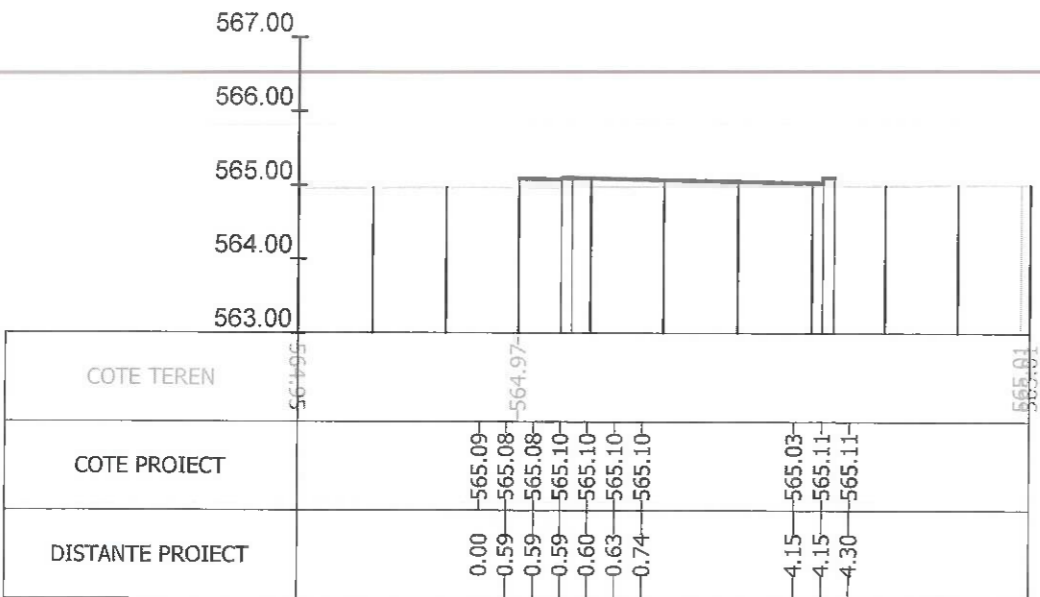

Sectiunea 296 - Km 4+125

Ax-Traseul 1

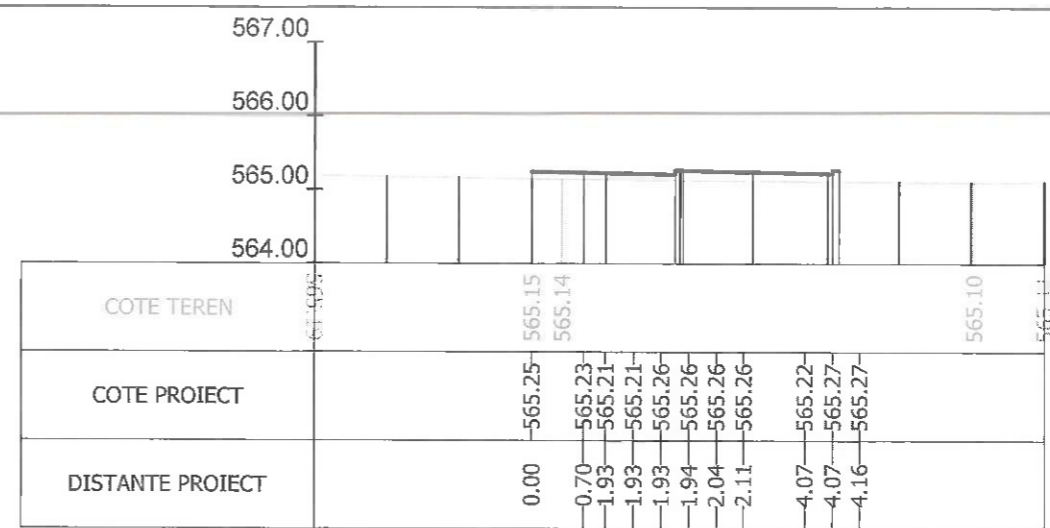

Sectiunea 293 - Km 4+075

Ax-Traseul 1

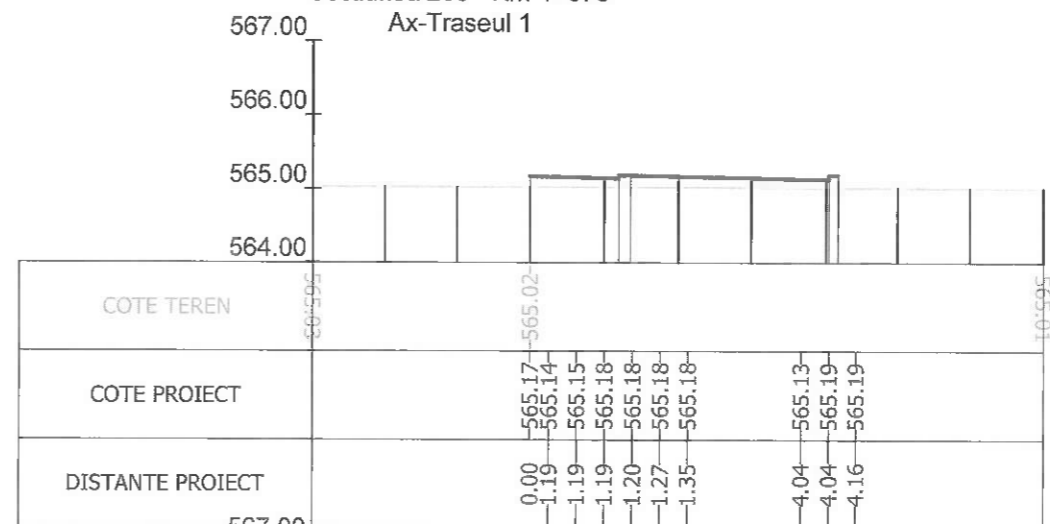

Sectiunea 295 - Km 4+100

Ax-Traseul 1

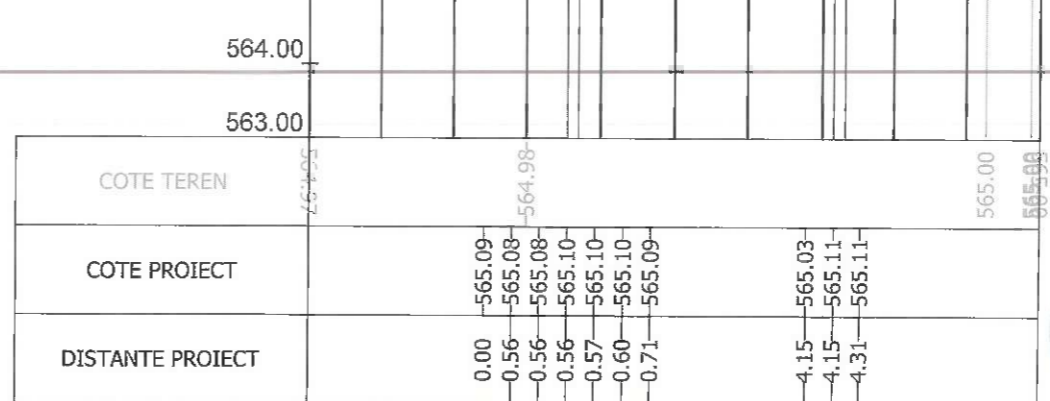

Sectiunea 297 - Km 4+126.386

Index	Data	Rev. 5
A		
		Beneficiar: MUNICIPIUL BRASOV Bulevardul Eroilor 8, Brasov 500007
Sef Proiect	Ing. A. Buta	Nr. proiect 73 / 2020
Proiectat	Ing. A. Buta	Faza P.T.
Desenat	Ing. S. Patroi	Nr. plansa PT-44
Verificat		
Scara 1/100		Titlu proiect: AMENAJARE BENZI DEDICATE TRANSPORTULUI PUBLIC IN MUNICIPIUL BRASOV SI TROTUARE ADIACENTE
Data 07/2023		Titlu plansa: PROFILE TRANSVERSALE CURENTE



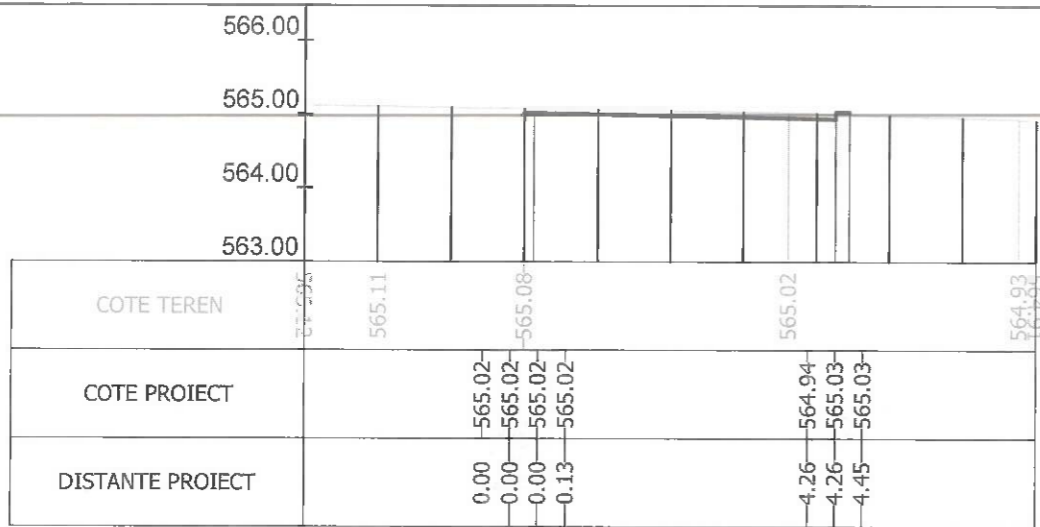

Sectiunea 298 - Km 4+150
Ax-Traseul 1

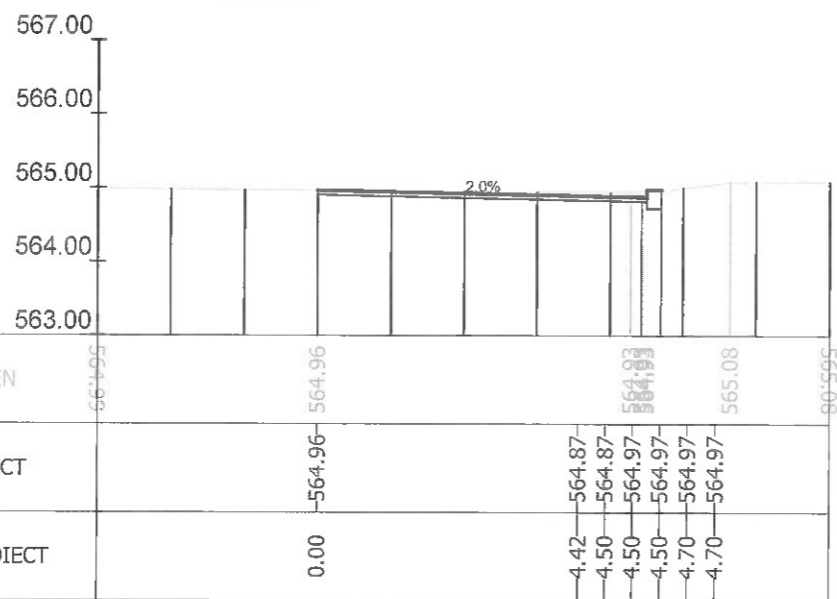

Sectiunea 300 - Km 4+158.374
Ax-Traseul 1

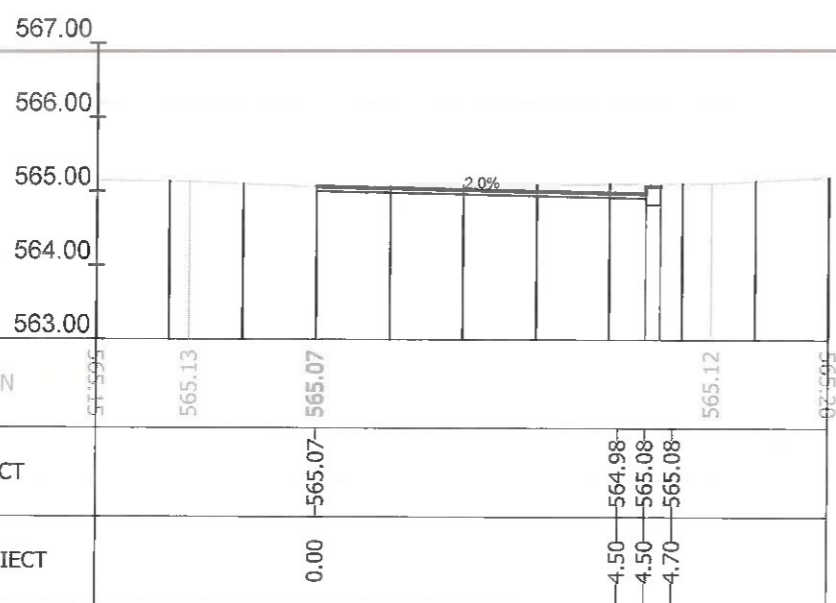

Sectiunea 302 - Km 4+200
Ax-Traseul 1

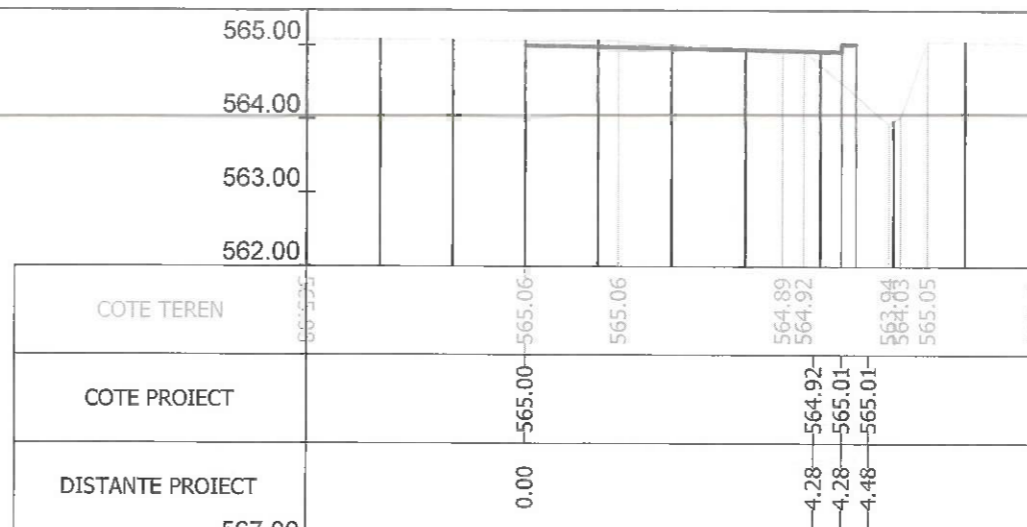

Sectiunea 299 - Km 4+155.384
Ax-Traseul 1

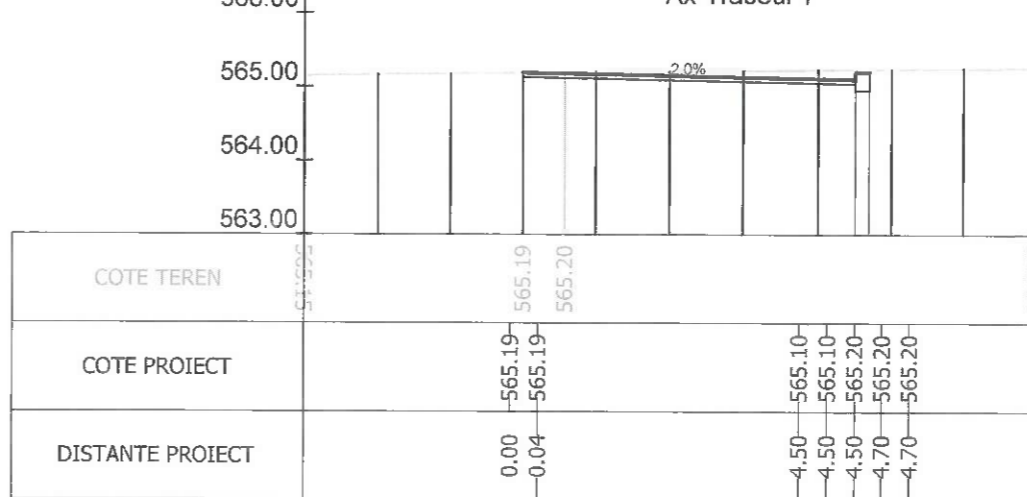

Sectiunea 301 - Km 4+175
Ax-Traseul 1

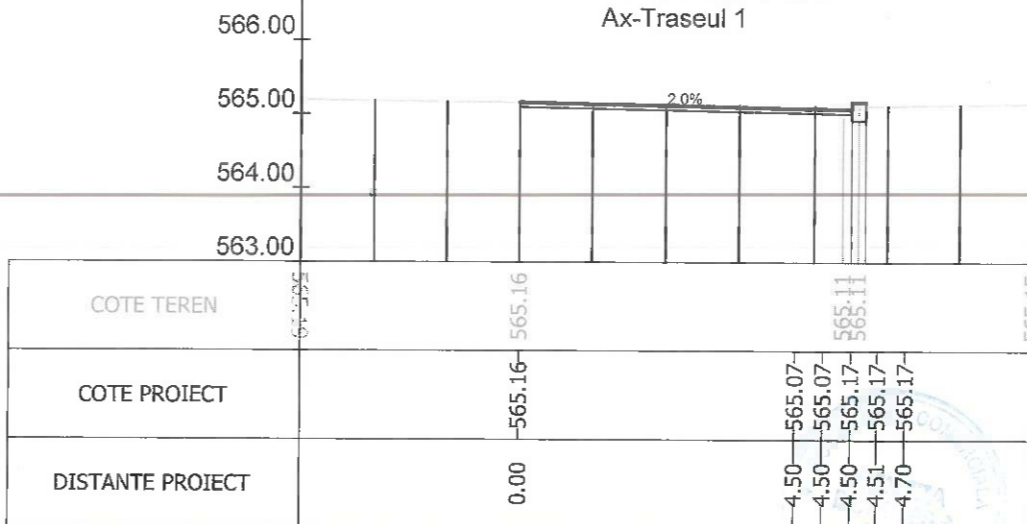

Sectiunea 303 - Km 4+203.970

Index	Data	Rev. 5
A		
		Beneficiar: MUNICIPIUL BRASOV Bulevardul Eroilor 8, Brasov 500007
Sef Proiect	Ing. A. Buta	Nr. proiect 73 / 2020
Proiectat	Ing. A. Buta	Titlu proiect: AMENAJARE BENZI DEDICATE TRANSPORTULUI PUBLIC IN MUNICIPIUL BRASOV SI TROTUARE ADIACENTE
Desenat	Ing. S. Patroi	Faza P.T.
Verificat		Titlu plansa: PROFILE TRANSVERSALE CURENTE
	Scara 1/100	Nr. plansa PT-45
	Data 07/2023	



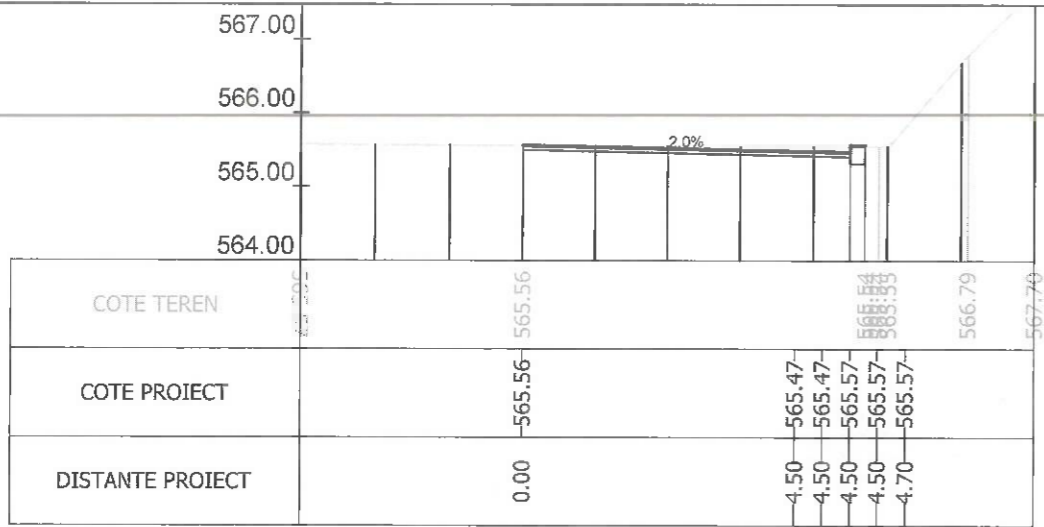

Sectiunea 310 - Km 4+277.980
Ax-Traseul 1

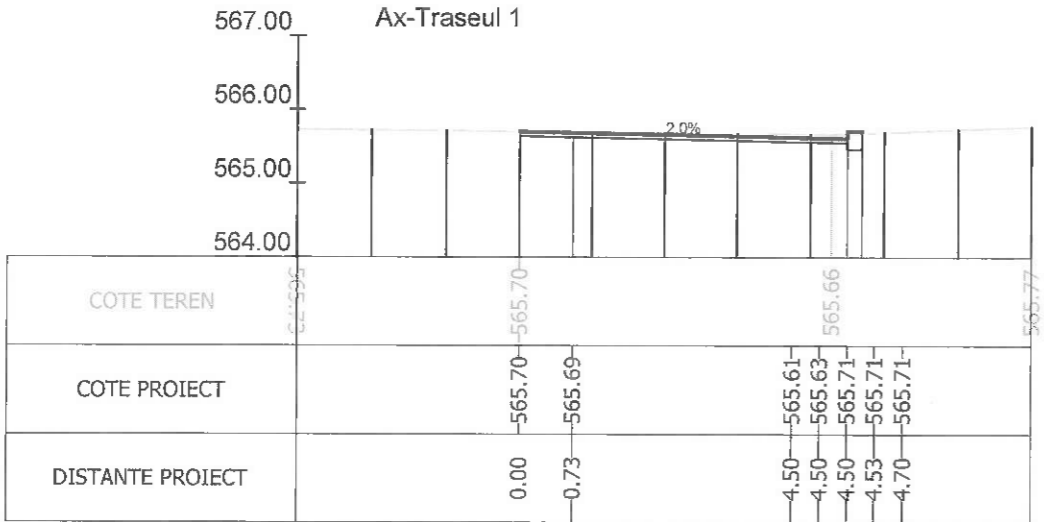

Sectiunea 311 - Km 4+300
Ax-Traseul 1

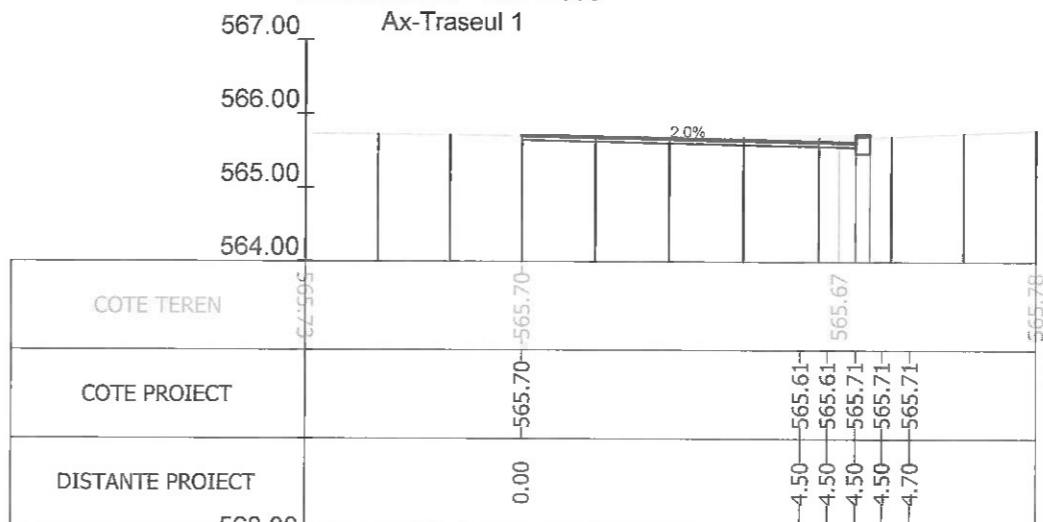

Sectiunea 312 - Km 4+325
Ax-Traseul 1

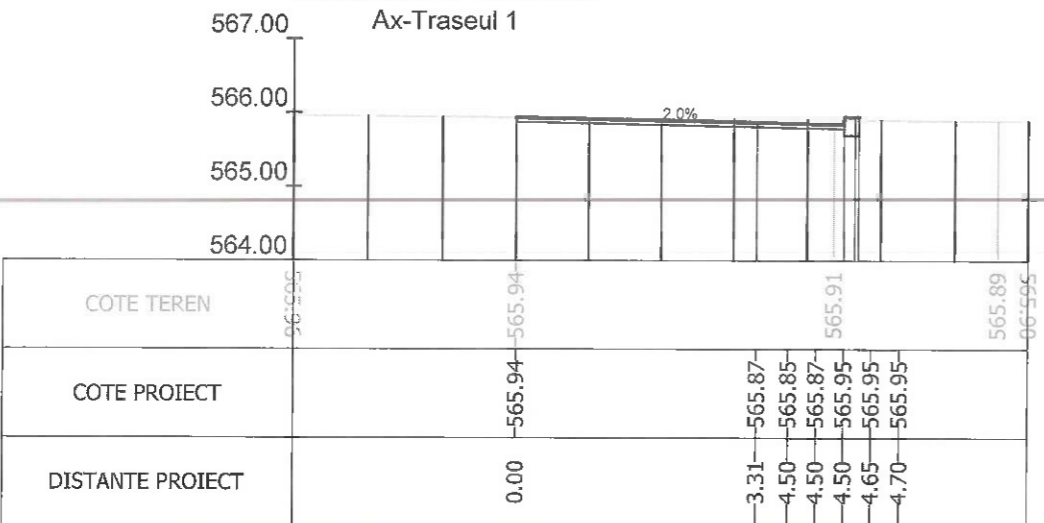

Sectiunea 313 - Km 4+325.968
Ax-Traseul 1

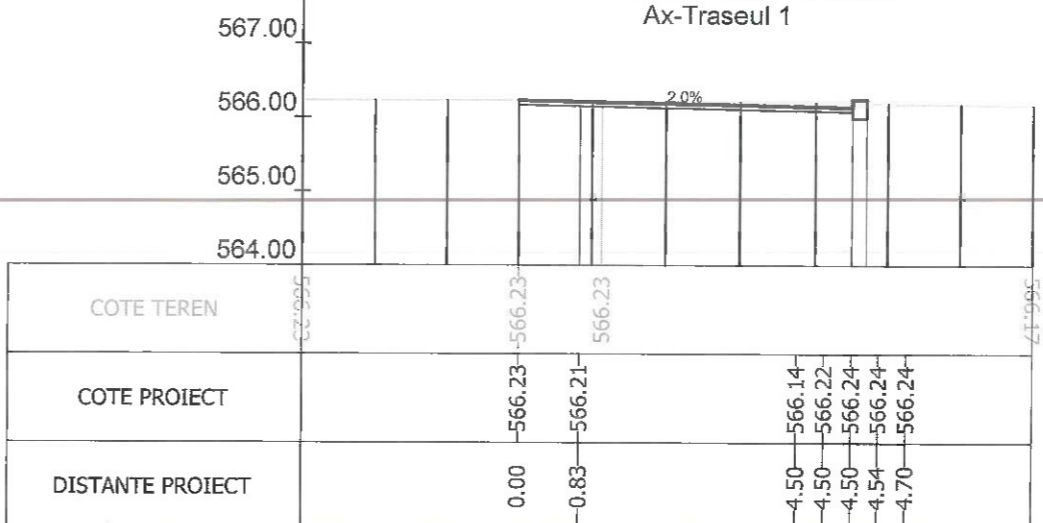

Sectiunea 314 - Km 4+350
Ax-Traseul 1

Sectiunea 315 - Km 4+375
Ax-Traseul 1

Index	A		Rev. 5	
				Beneficiar:
Sef Proiect	Ing. A. Buta		Scara	1/100
Proiectat	Ing. A. Buta		Data	07/2023
Desenat	Ing. S. Patroi		Titlu plansa:	PROFILE TRANSVERSALE CURENTE
Verificat			Nr. plansa	PT-47

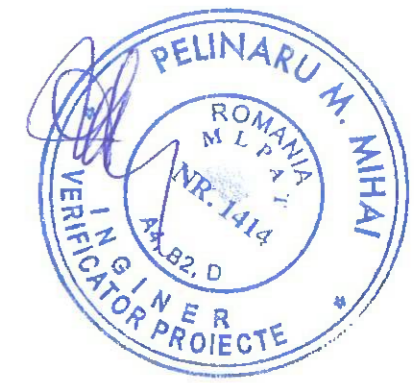

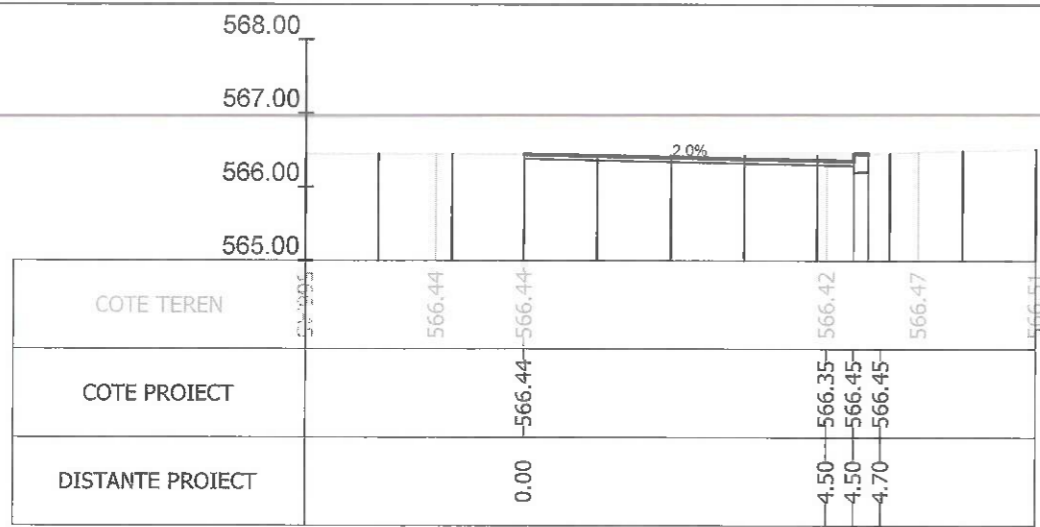

Sectiunea 316 - Km 4+400
Ax-Traseul 1

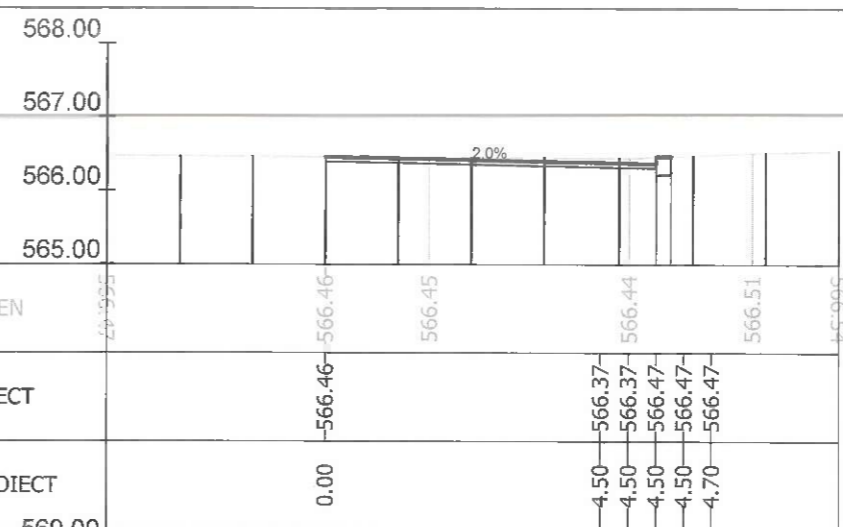
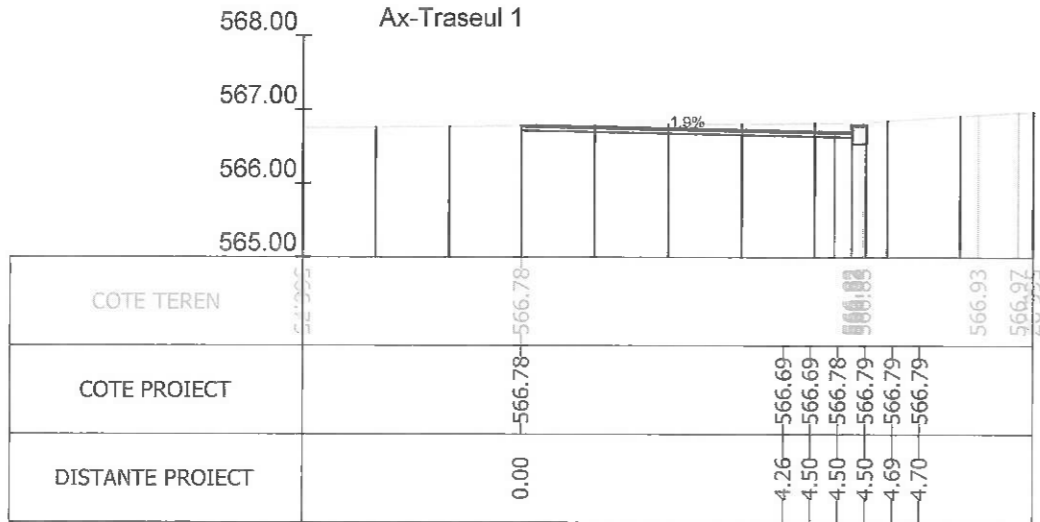

Sectiunea 317 - Km 4+400.843
Ax-Traseul 1

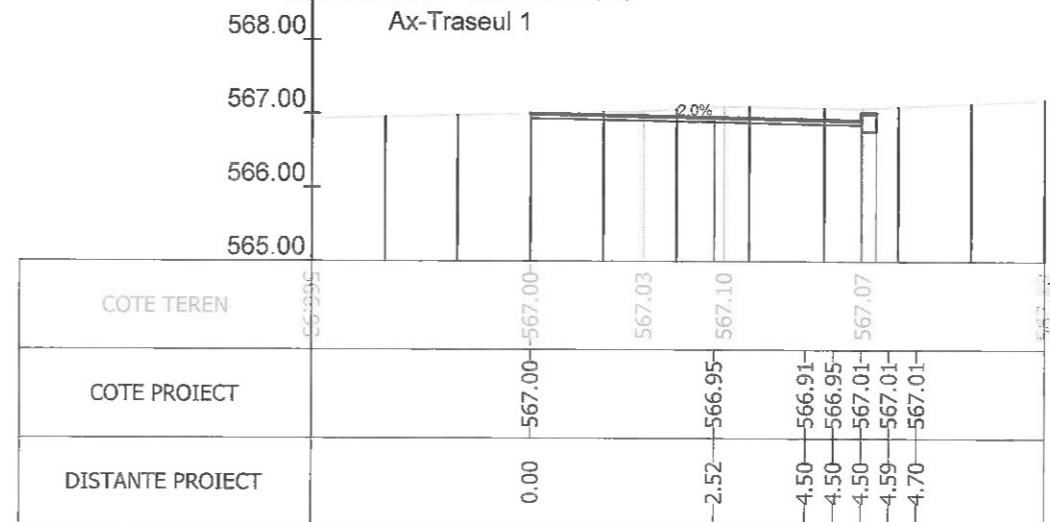

Sectiunea 319 - Km 4+425
Ax-Traseul 1

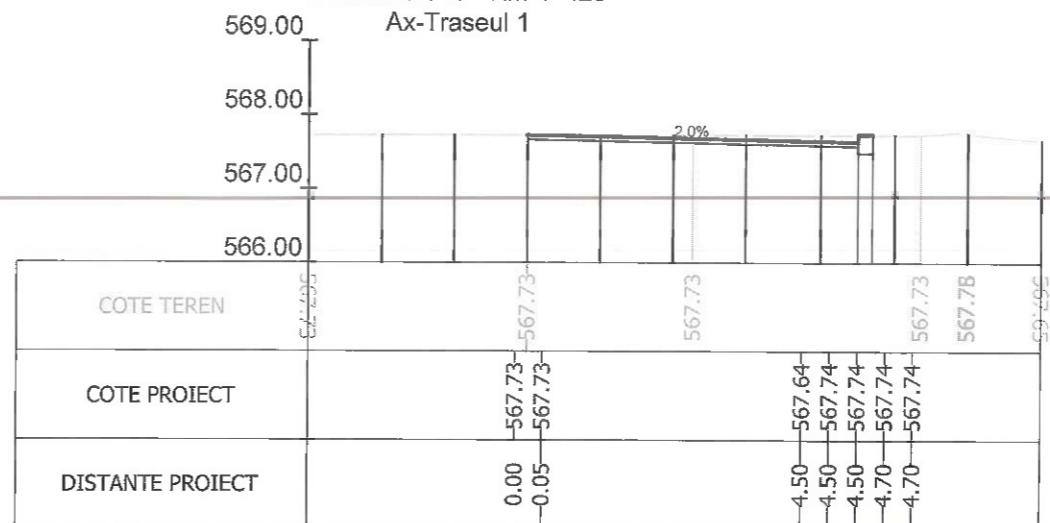

Sectiunea 320 - Km 4+437.721
Ax-Traseul 1

Index		Data		Rev. 5	
A					
		Beneficiar:		MUNICIPIUL BRASOV Bulevardul Eroilor 8, Brasov 500007	
		Titlu proiect:		AMENAJARE BENZI DEDICATE TRANSPORTULUI PUBLIC IN MUNICIPIUL BRASOV SI TROTUARE ADIACENTE	
Sef Proiect		Ing. A. Buta		Nr. proiect 73 / 2020	
Proiectat		Ing. A. Buta		Faza P.T.	
Desenat		Ing. S. Patroi		Titlu plansa:	
Verificat				PROFILE TRANSVERSALE CURENTE	
		Scara 1/100		Nr. plansa PT-48	
		Data 07/2023			



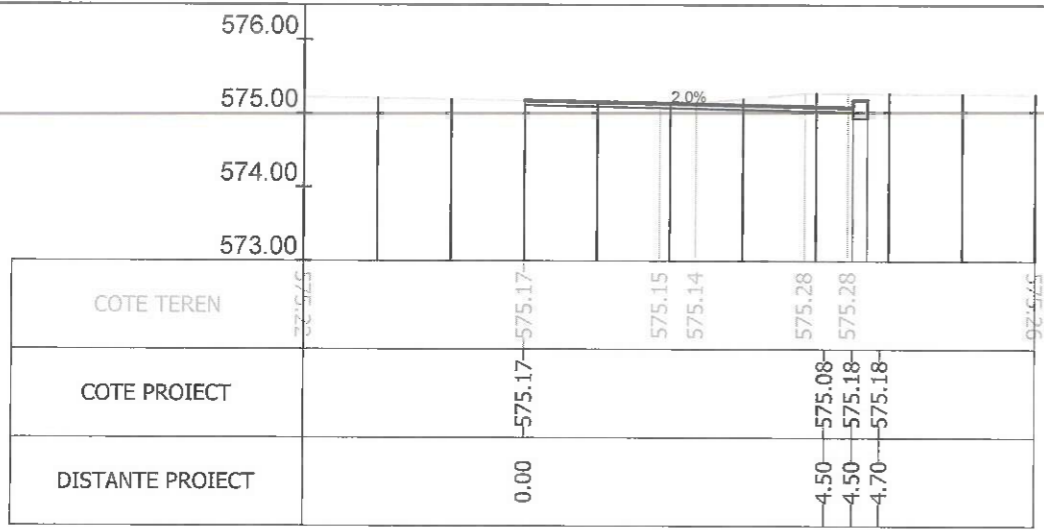

Sectiunea 365 - Km 4+944.447

Ax-Traseul 1

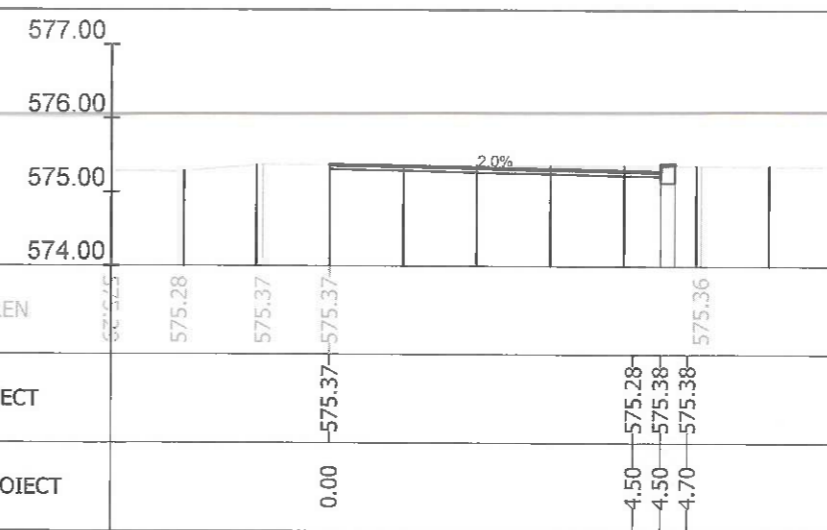
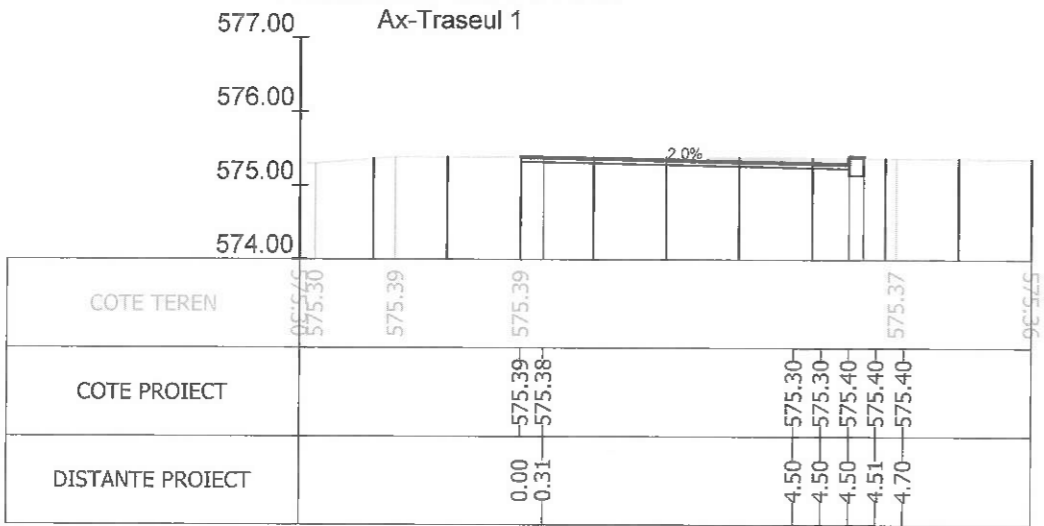

Sectiunea 366 - Km 4+949.248

Ax-Traseul 1

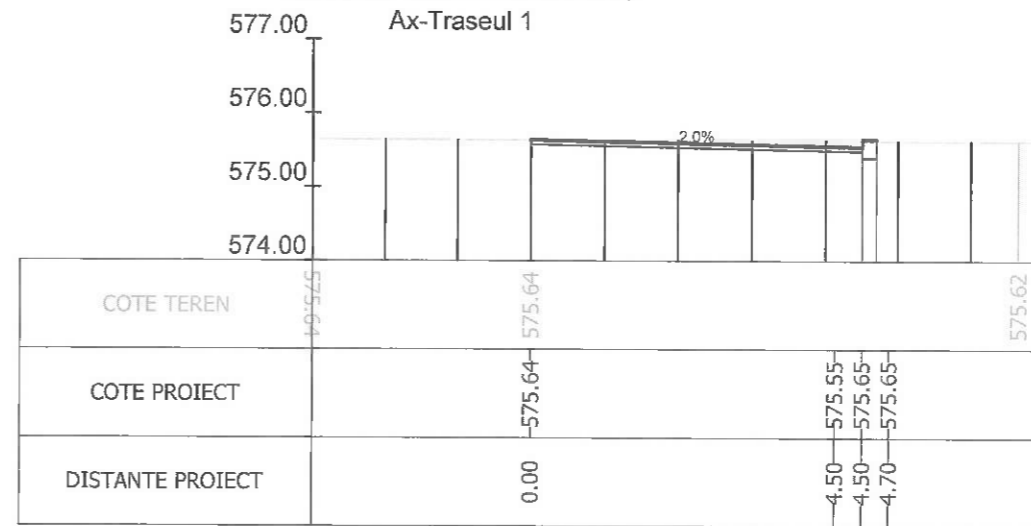

Sectiunea 368 - Km 4+963.278

Ax-Traseul 1

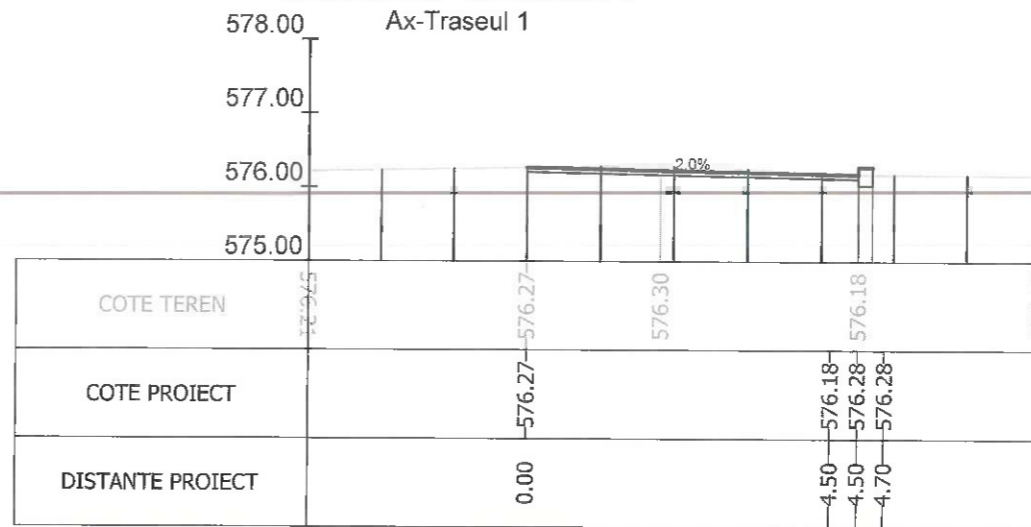

Sectiunea 369 - Km 4+975

Ax-Traseul 1

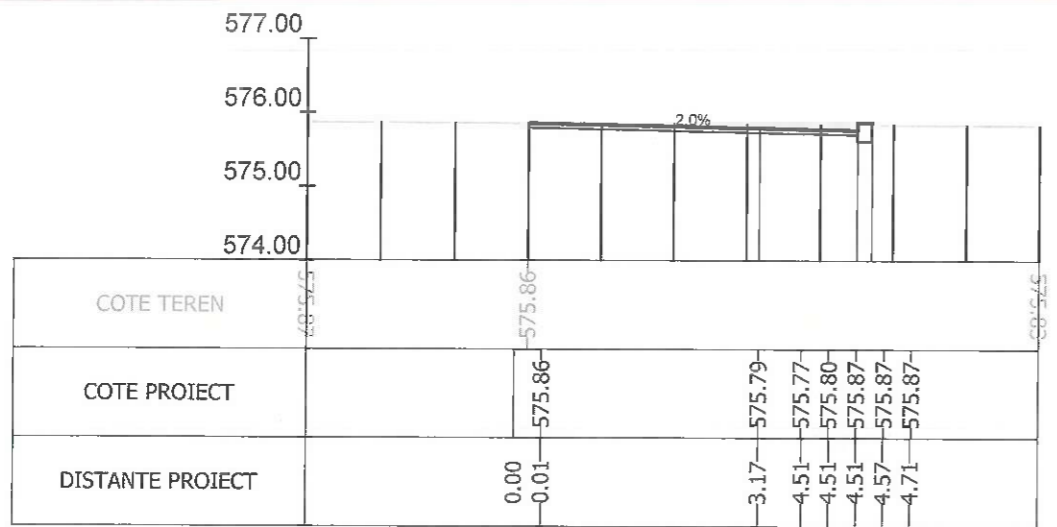

Sectiunea 370 - Km 4+993.682

Ax-Traseul 1

Index	Data	Descriere	Rev. 5
A			

HENTZA BUSINESS

www.hentza.ro

ROU, PENTRU PLANUL NR. 17 BRBU NR. 2 ETIAJ 4, VOLUNTARI ILDOV, TEL. +40 87 494 0549, EMAIL OFFICE@HENTZA.RO

Sef Proiect	Ing. A. Buta	Scara	
Proiectat	Ing. A. Buta	1/100	
Desenat	Ing. S. Patroi	Data	
Verificat		07/2023	

Beneficiar:	MUNICIPIUL BRASOV Bulevardul Eroilor 8, Brasov 500007
Titlu proiect:	AMENAJARE BENZI DEDICATE TRANSPORTULUI PUBLIC IN MUNICIPIUL BRASOV SI TROTUARE ADIACENTE
Titlu plansa:	PROFILE TRANSVERSALE CURENTE
Nr. proiect	73 / 2020
Faza	P.T.
Nr. plansa	PT-51



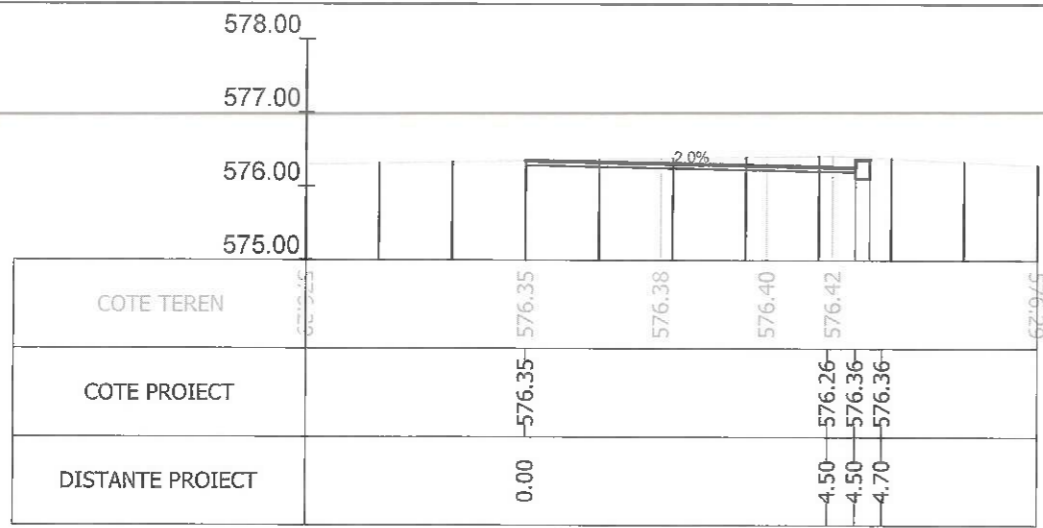

Sectiunea 371 - Km 5+000
Ax-Traseul 1

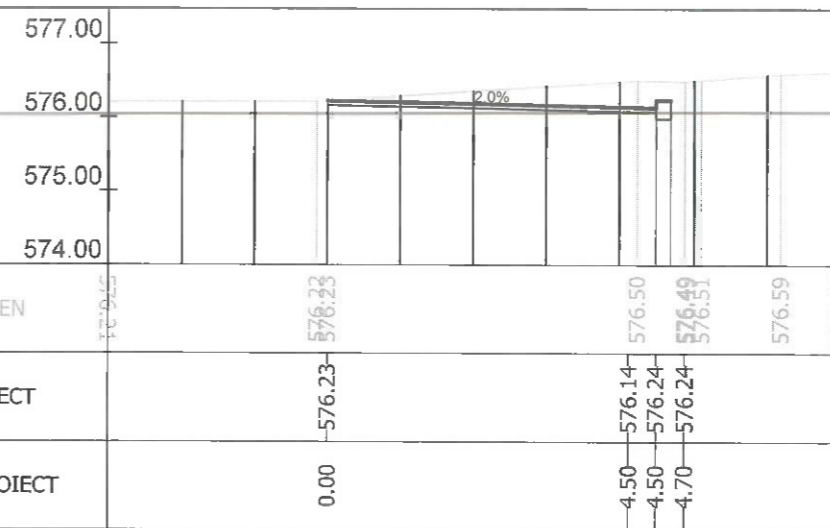
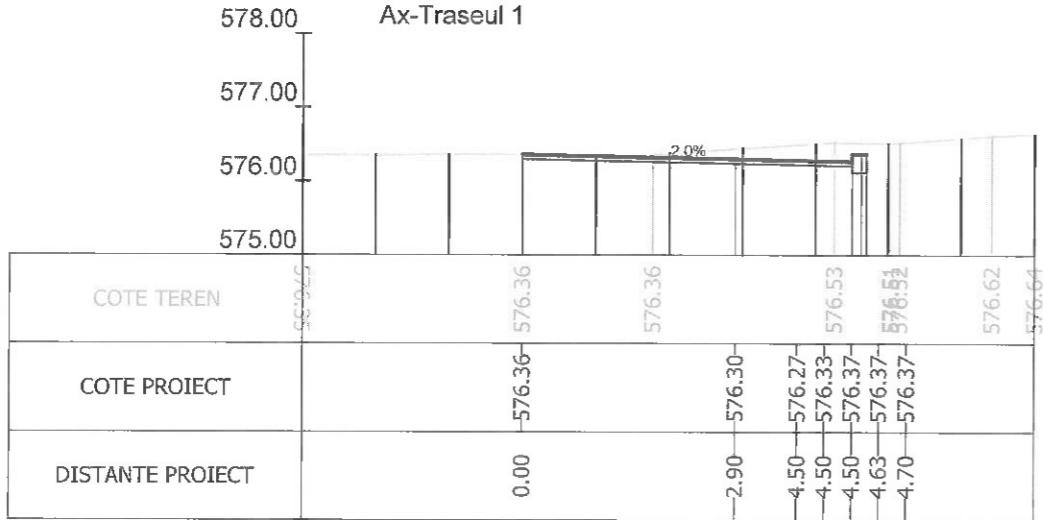

Sectiunea 372 - Km 5+024.085
Ax-Traseul 1

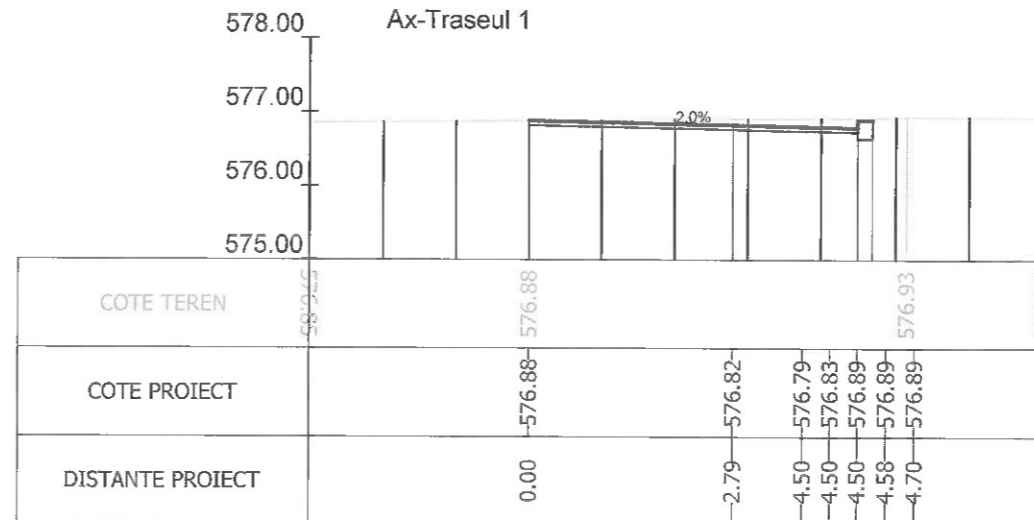

Sectiunea 373 - Km 5+025
Ax-Traseul 1

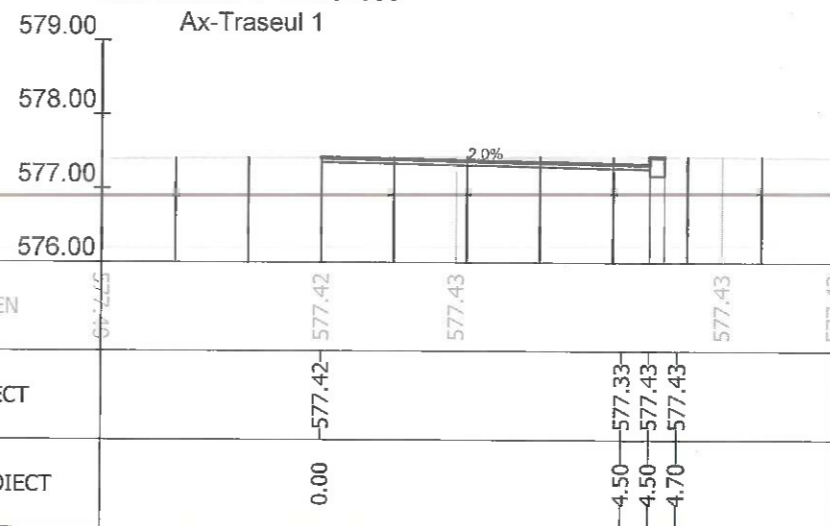
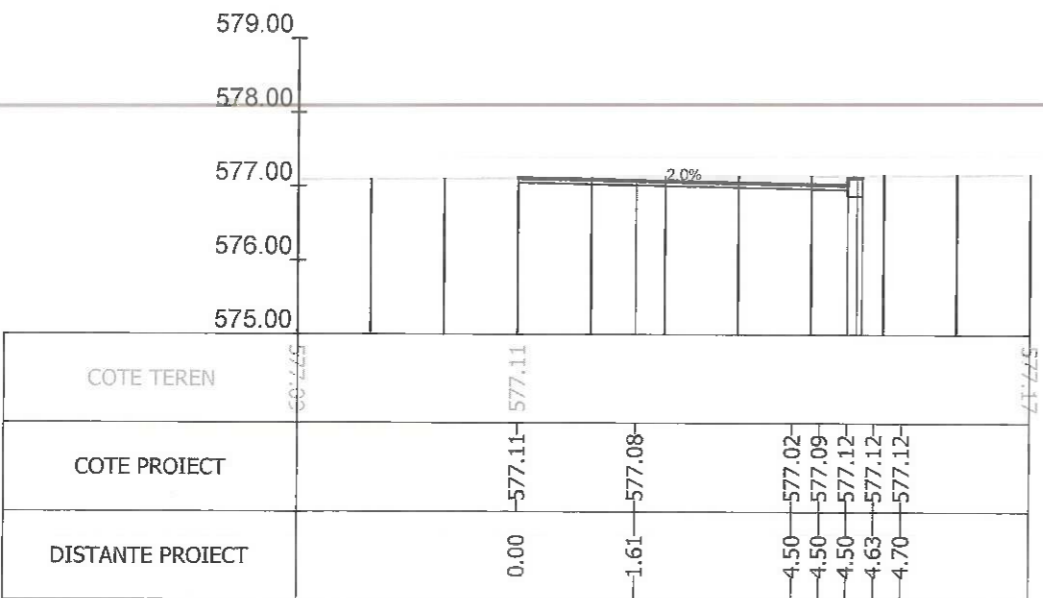

Sectiunea 375 - Km 5+075
Ax-Traseul 1

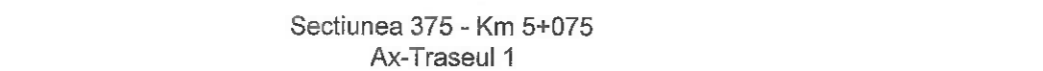

Index		Data		Rev. 5	
A					
		Beneficiar:		MUNICIPIUL BRASOV Bulevardul Eroilor 8, Brasov 500007	
		Titlu proiect:		AMENAJARE BENZI DEDICATE TRANSPORTULUI PUBLIC IN MUNICIPIUL BRASOV SI TROTUARE ADIACENTE	
Sef Proiect		Ing. A. Buta		Nr. proiect 73 / 2020	
Proiectat		Ing. A. Buta		Faza P.T.	
Desenat		Ing. S. Patroi		Titlu planşa:	
Verificat				PROFILE TRANSVERSALE CURENTE	
		Scara 1/100		Nr. planşa PT-52	
		Data 07/2023			

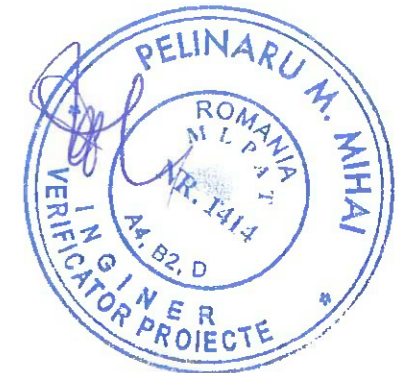

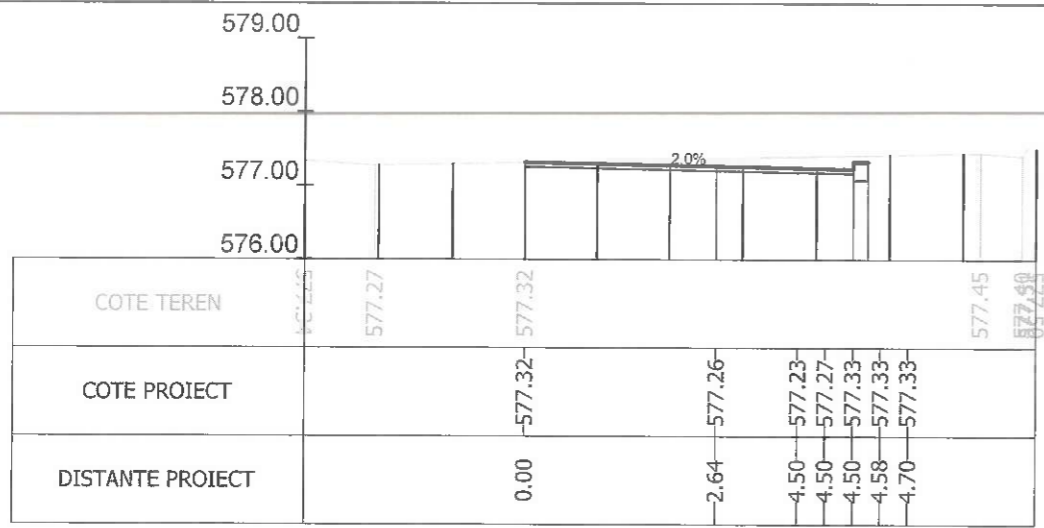

Sectiunea 377 - Km 5+125
Ax-Traseul 1

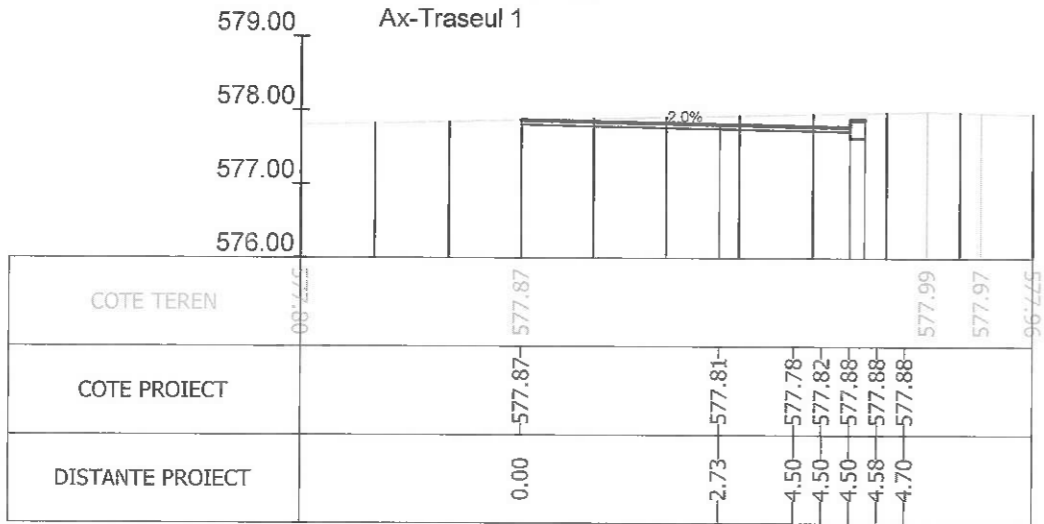

Sectiunea 379 - Km 5+175
Ax-Traseul 1

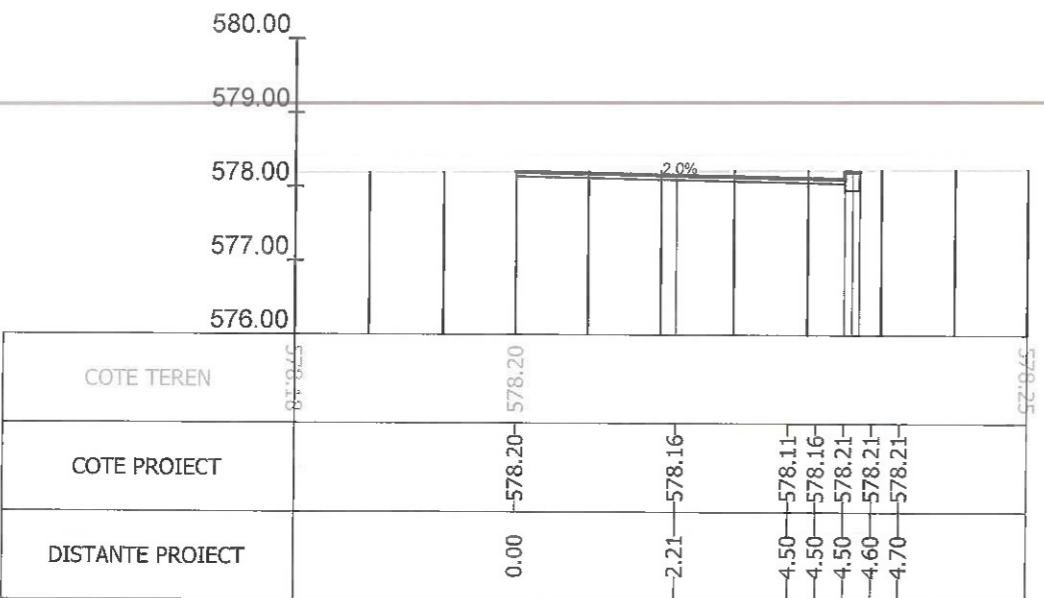

Sectiunea 381 - Km 5+225
Ax-Traseul 1

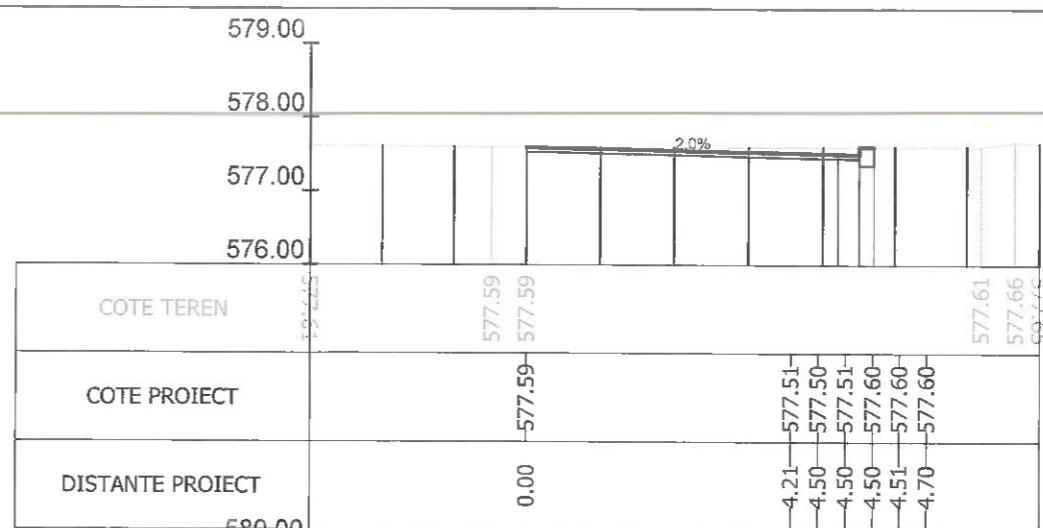

Sectiunea 378 - Km 5+150
Ax-Traseul 1

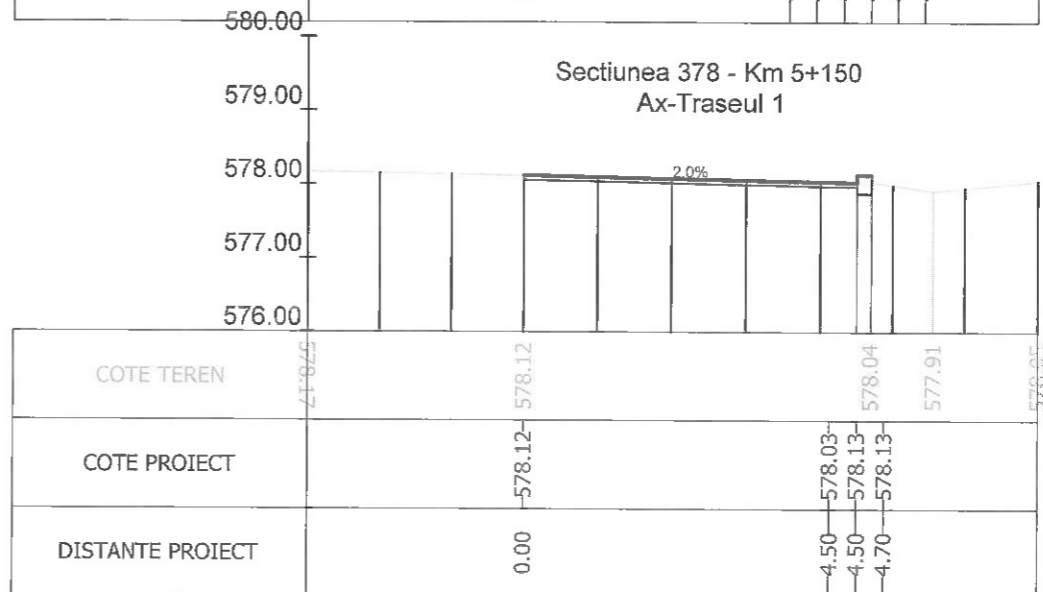

Sectiunea 380 - Km 5+200
Ax-Traseul 1

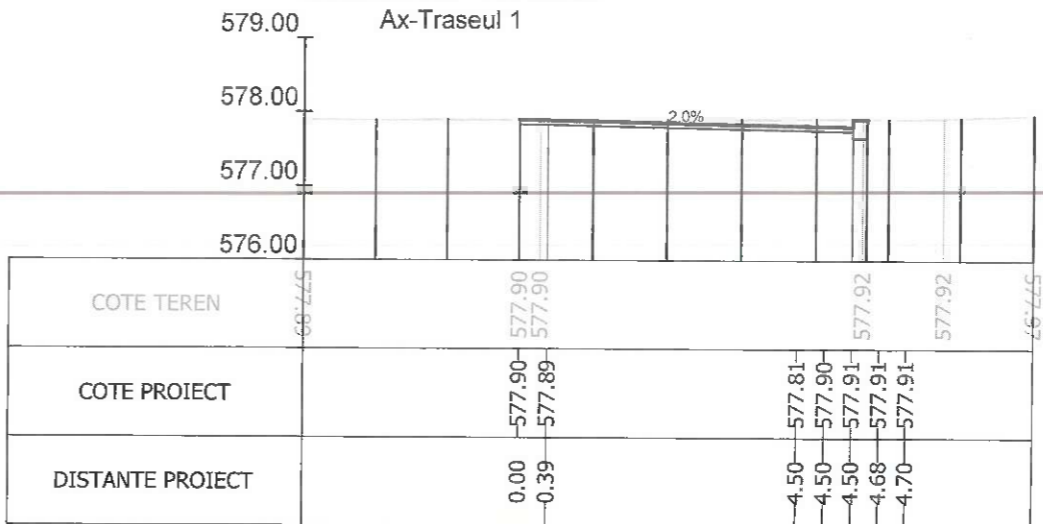

Sectiunea 382 - Km 5+250
Ax-Traseul 1

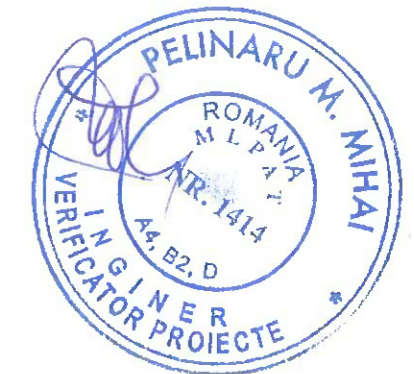

Index	Data	Observatii	Rev. 5
A			
		Beneficiar:	MUNICIPIUL BRASOV Bulevardul Eroilor 8, Brasov 500007
Sef Proiect: Ing. A. Buta Proiectat: Ing. A. Buta Desenat: Ing. S. Patroi Verificat:		Titlu proiect:	AMENAJARE BENZI DEDICATE TRANSPORTULUI PUBLIC IN MUNICIPIUL BRASOV SI TROTUARE ADIACENTE
Scara: 1/100 Data: 07/2023		Titlu plansa:	PROFILE TRANSVERSALE CURENTE
		Nr. proiect:	73 / 2020
		Faza:	P.T.
		Nr. plansa:	PT-53

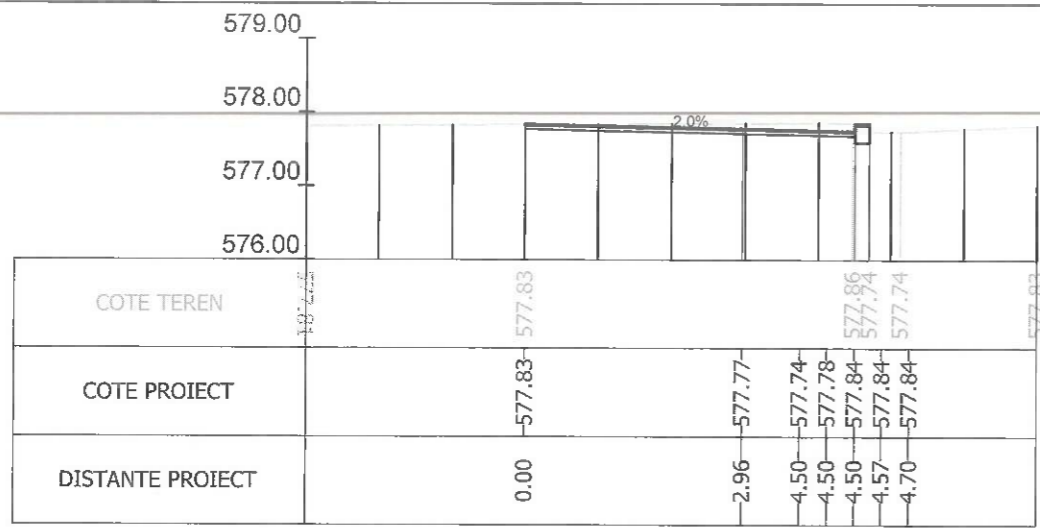

Sectiunea 383 - Km 5+275
Ax-Traseul 1

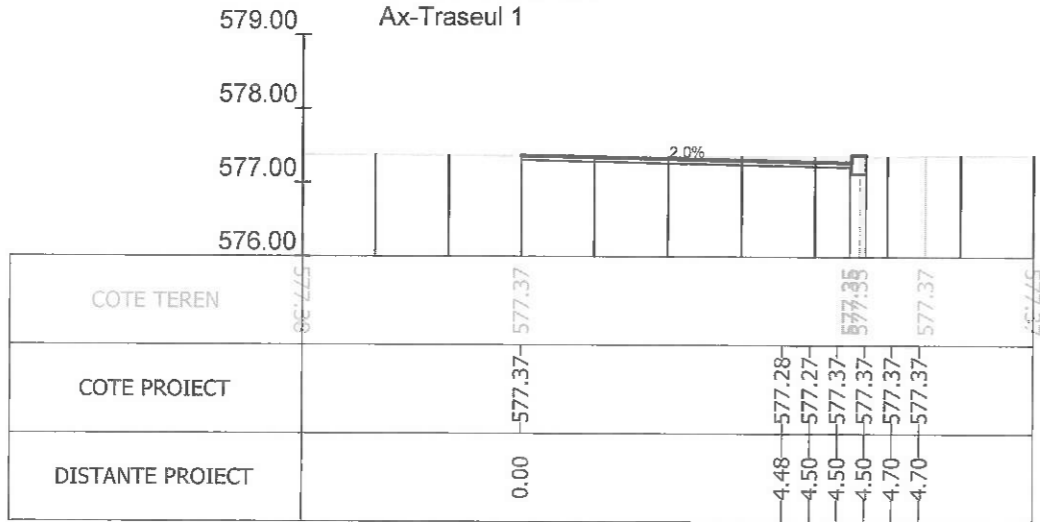

Sectiunea 385 - Km 5+313.849
Ax-Traseul 1

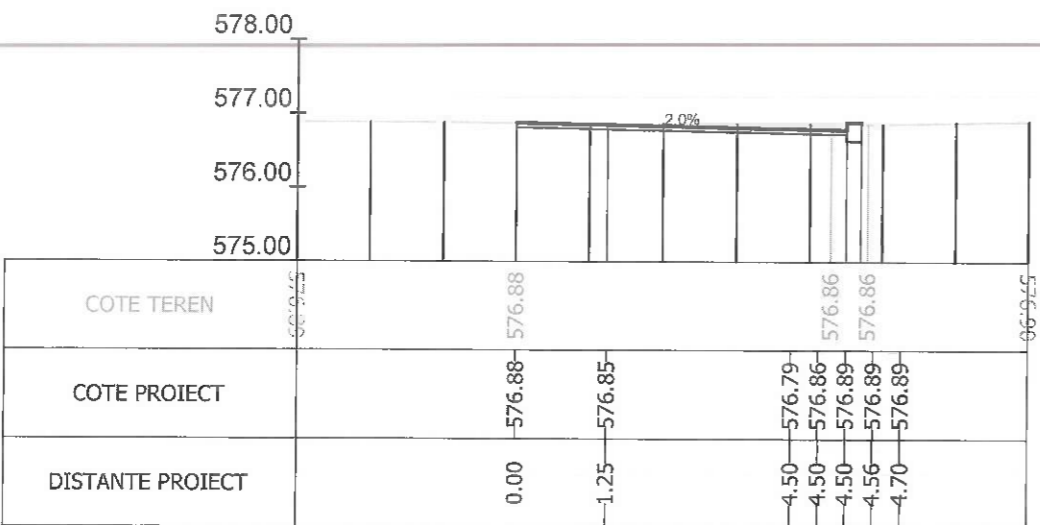

Sectiunea 387 - Km 5+350
Ax-Traseul 1

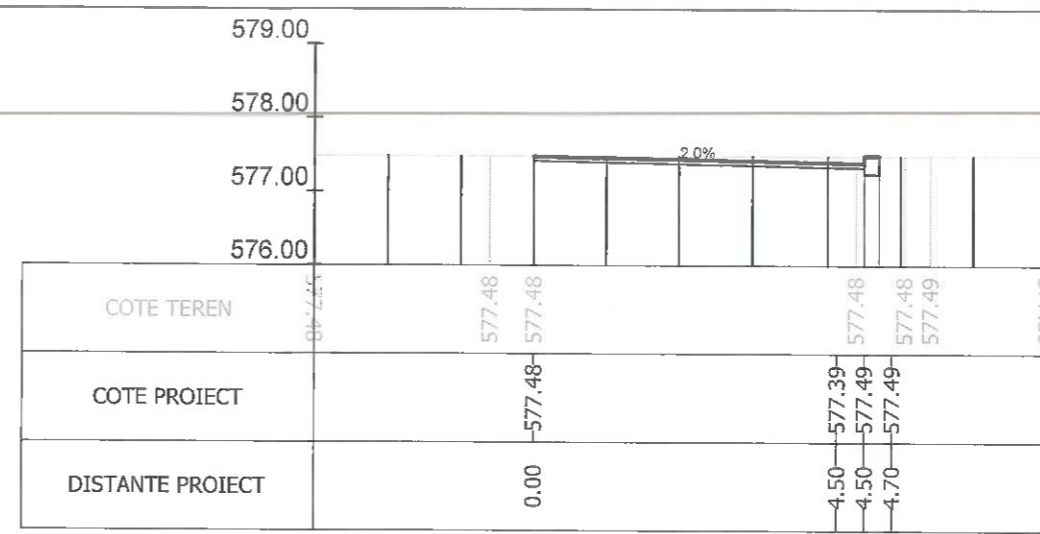

Sectiunea 384 - Km 5+300
Ax-Traseul 1

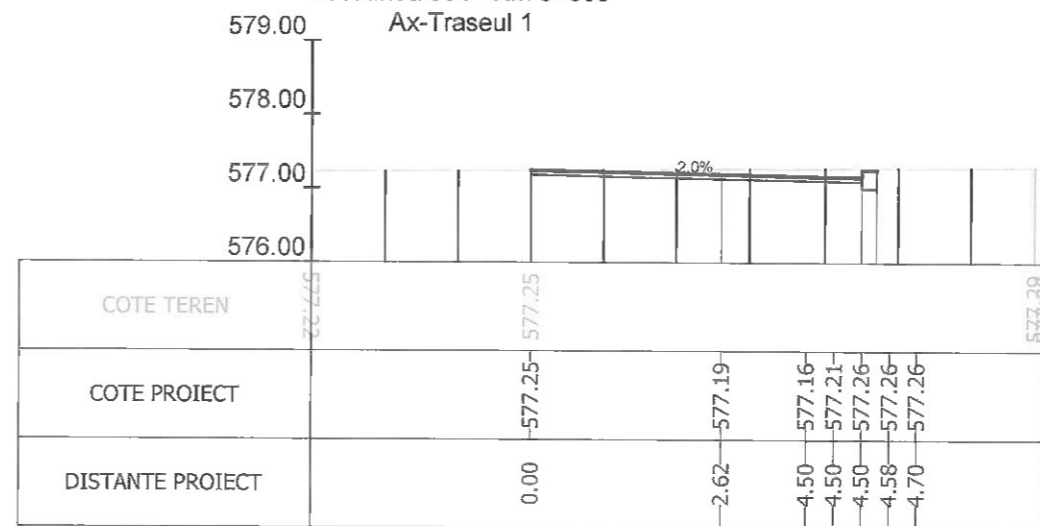

Sectiunea 386 - Km 5+325
Ax-Traseul 1

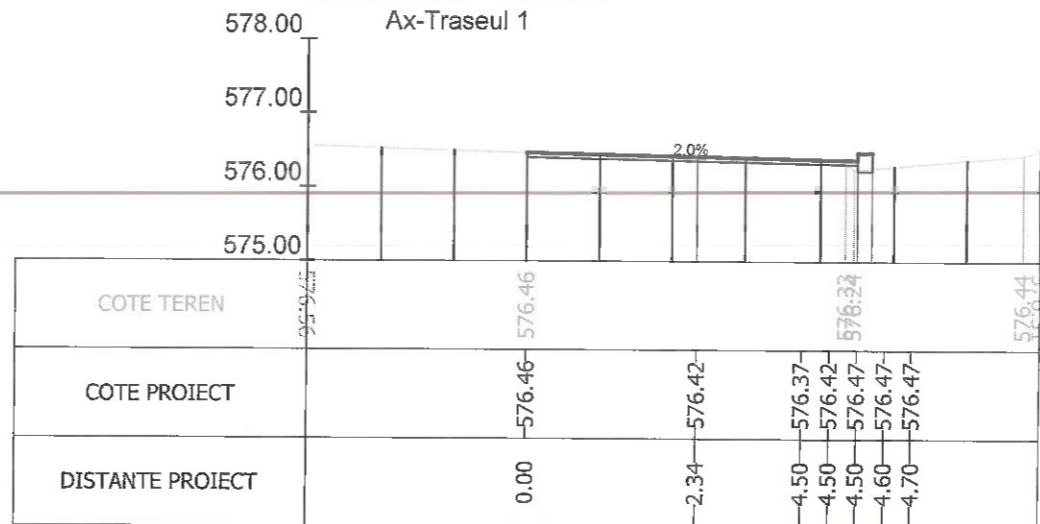

Sectiunea 388 - Km 5+375
Ax-Traseul 1

Index	Data	Rev. 5
A		
Sef Proiect	Ing. A. Buta	Beneficiar:
Proiectat	Ing. A. Buta	MUNICIPIUL BRASOV
Desenat	Ing. S. Patroi	Bulevardul Eroilor 8, Brasov 500007
Verificat		Nr. proiect
		73 / 2020
		Titlu proiect:
		AMENAJARE BENZI DEDICATE
		TRANSPORTULUI PUBLIC IN MUNICIPIUL
		BRASOV SI TROTUARE ADIACENTE
		Faza
		P.T.
		Titlu plansa:
		PROFILE TRANSVERSALE
		CURENTE
		Nr. plansa
		PT-54

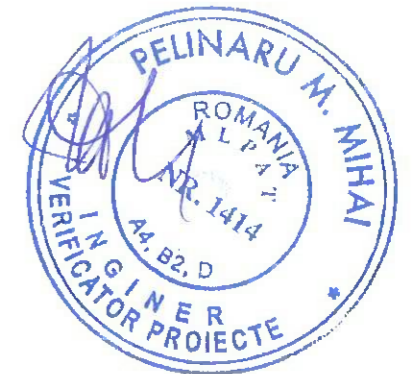

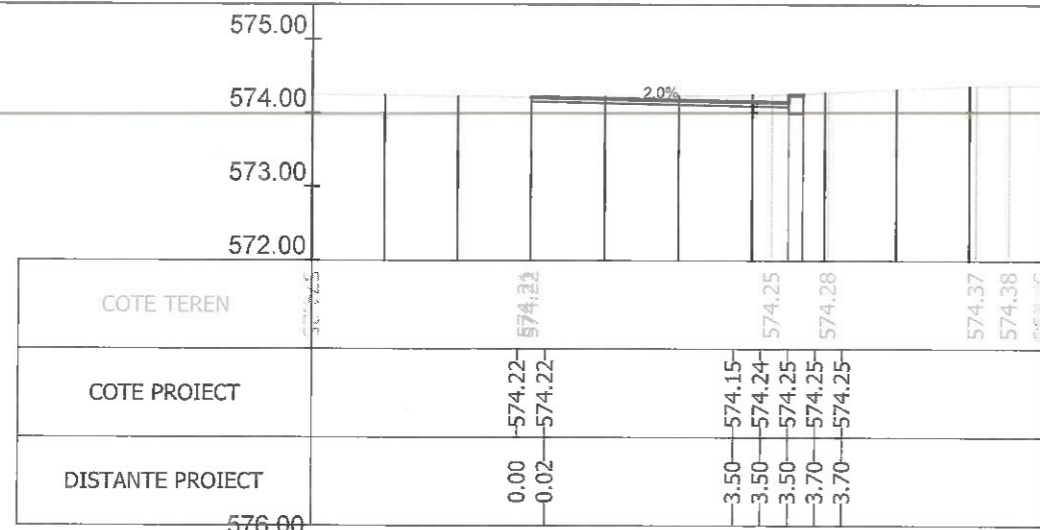

Sectiunea 399 - Km 5+475
Ax-Traseul 1

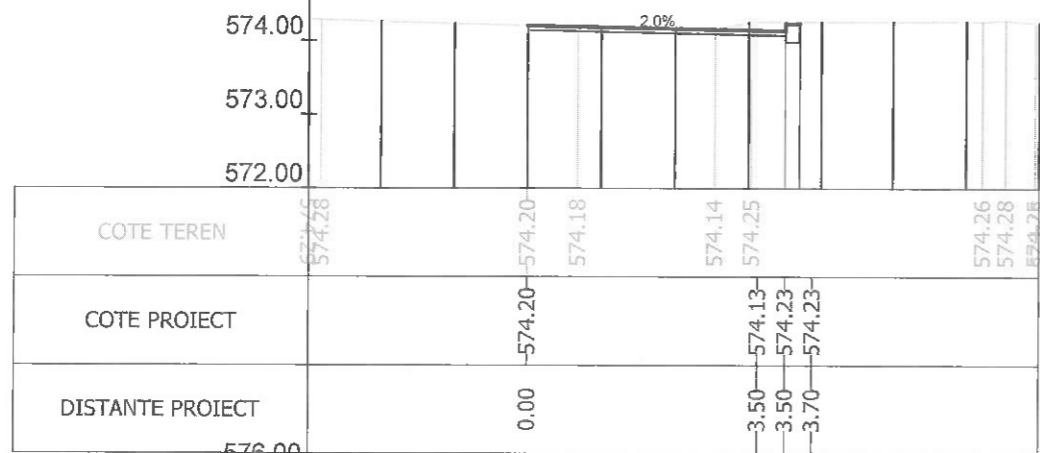

Sectiunea 401 - Km 5+480.669
Ax-Traseul 1

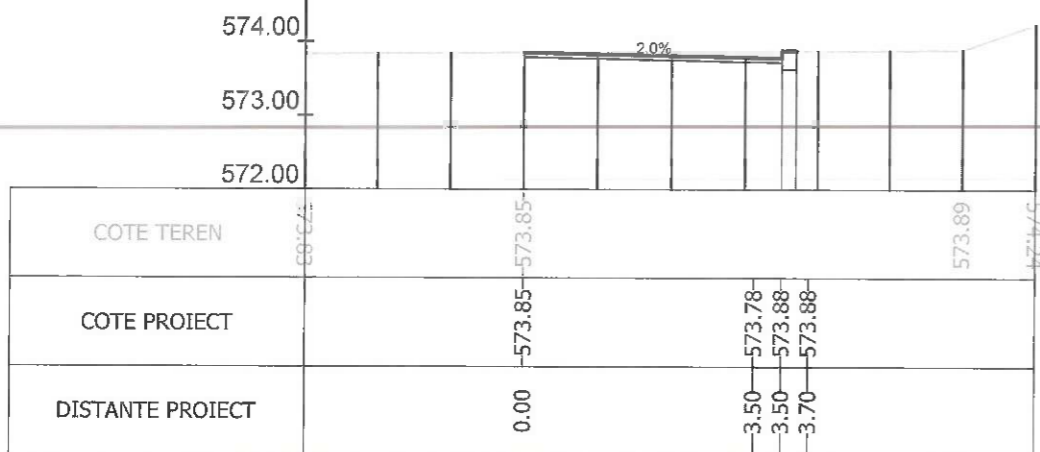

Sectiunea 403 - Km 5+500
Ax-Traseul 1

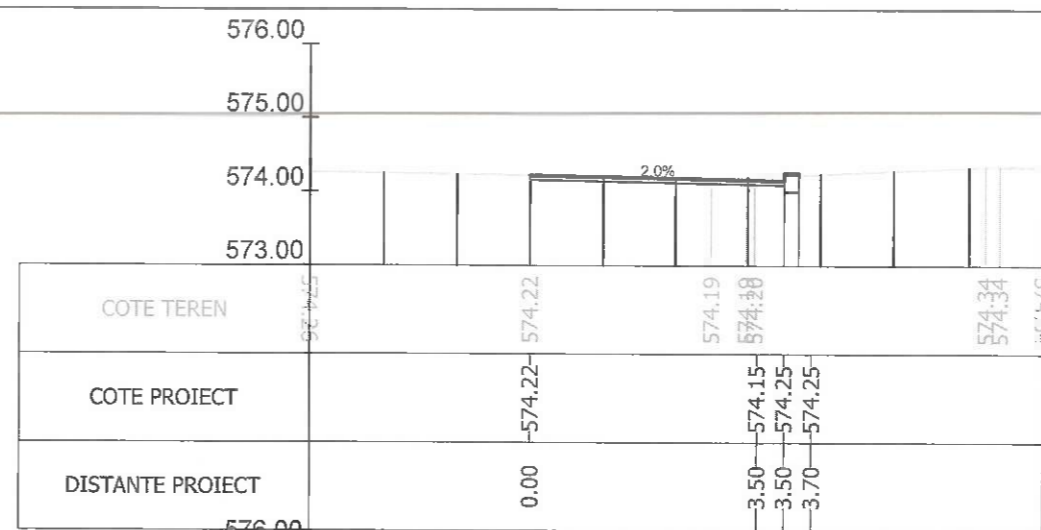

Sectiunea 400 - Km 5+476.522
Ax-Traseul 1

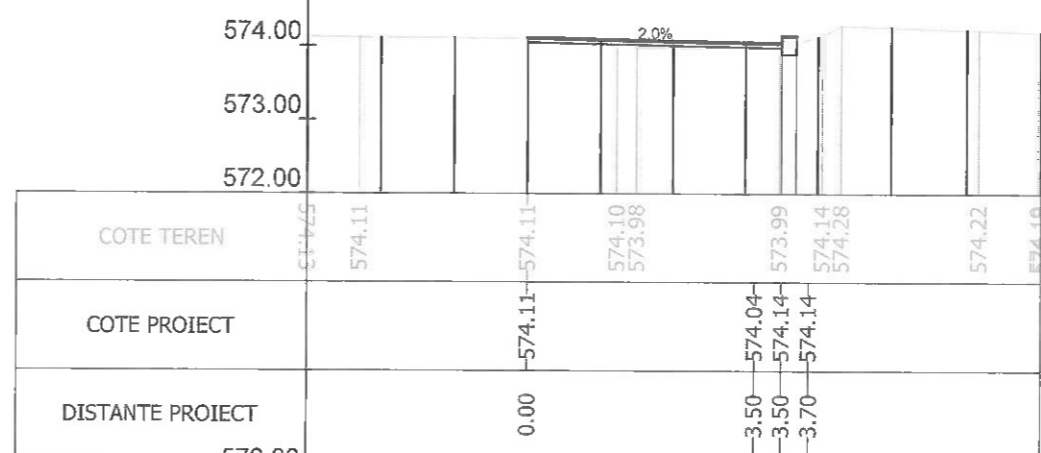

Sectiunea 402 - Km 5+484.815
Ax-Traseul 1

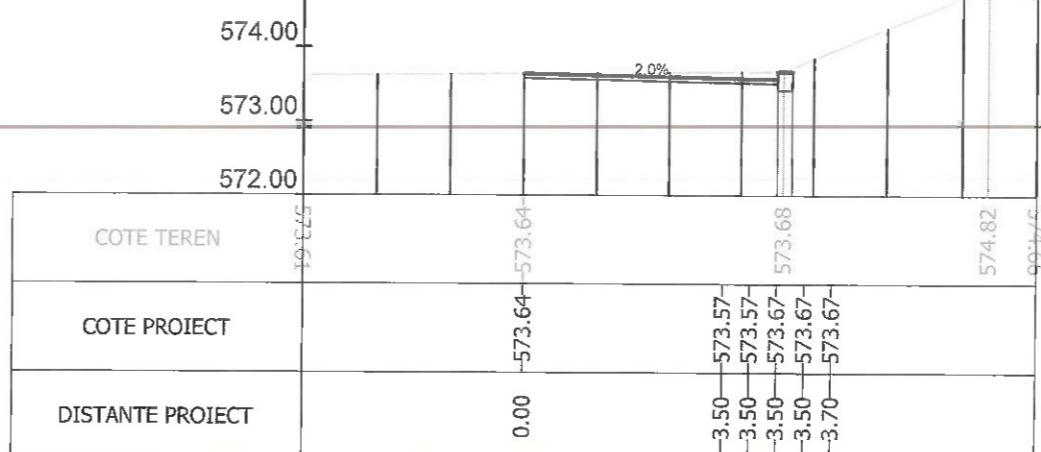

Sectiunea 404 - Km 5+511.245
Ax-Traseul 1

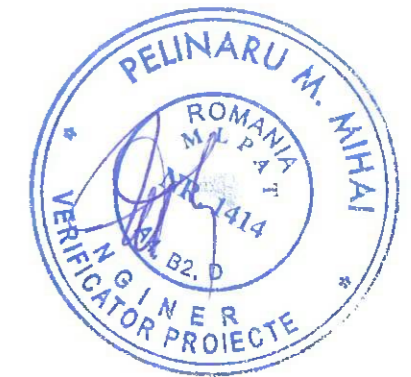

Index	A		Rev. 5
			Beneficiar: MUNICIPIUL BRASOV Bulevardul Eroilor 8, Brasov 500007
Sef Proiect: Ing. A. Buta Proiectat: Ing. A. Buta Desenat: Ing. S. Patroi Verificat:			Nr. proiect: 73 / 2020 Faza: P.T. Nr. plansa: PT-56
Scara: 1/100 Data: 07/2023			Titlu proiect: AMENAJARE BENZI DEDICATE TRANSPORTULUI PUBLIC IN MUNICIPIUL BRASOV SI TROTUARE ADIACENTE Titlu plansa: PROFILE TRANSVERSALE CURENTE

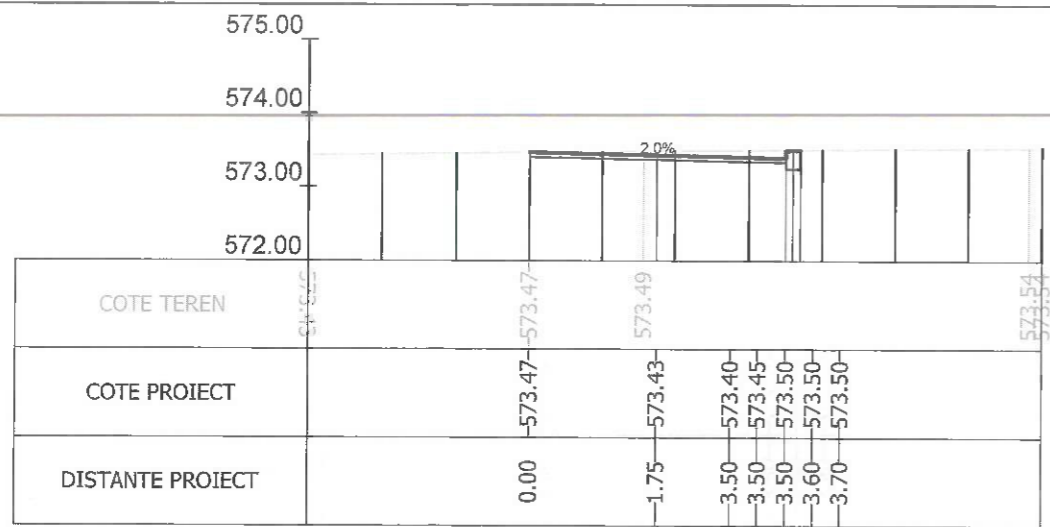

Sectiunea 405 - Km 5+525
Ax-Traseul 1

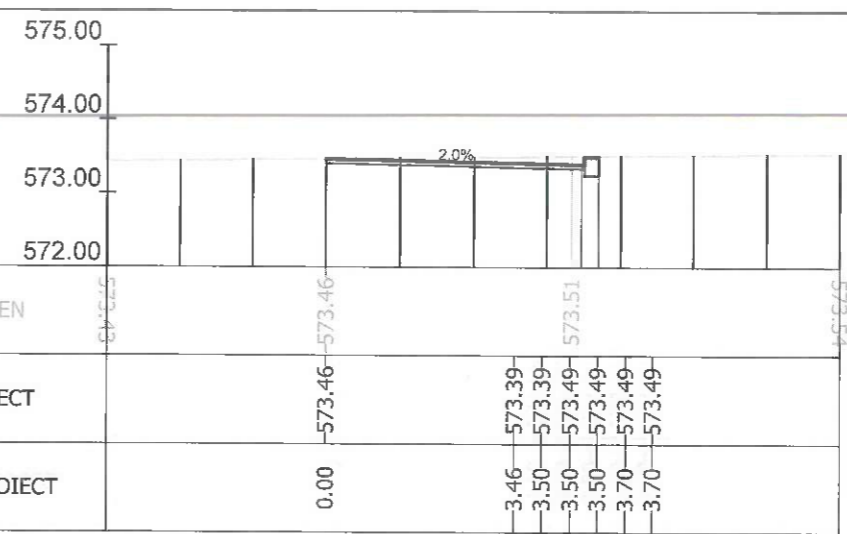
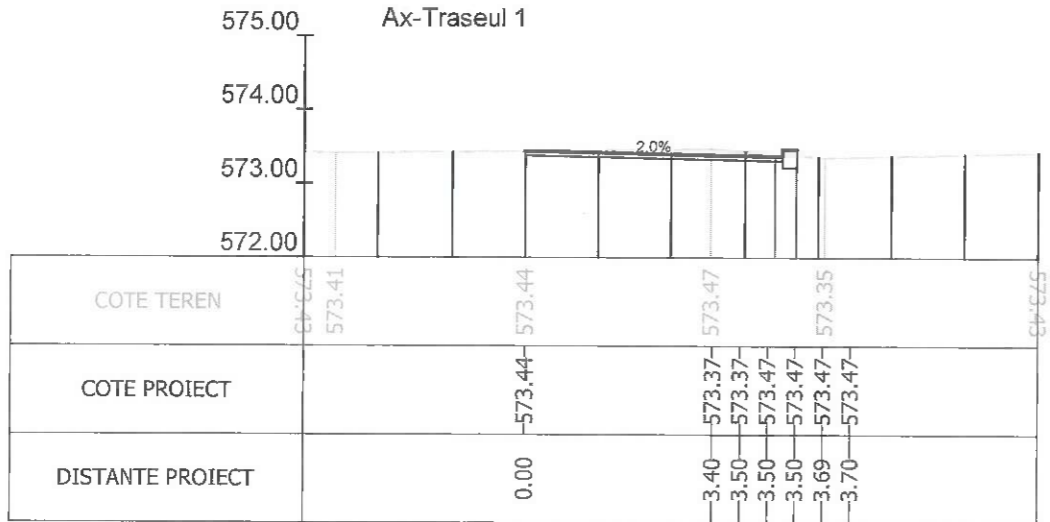

Sectiunea 406 - Km 5+525.867
Ax-Traseul 1

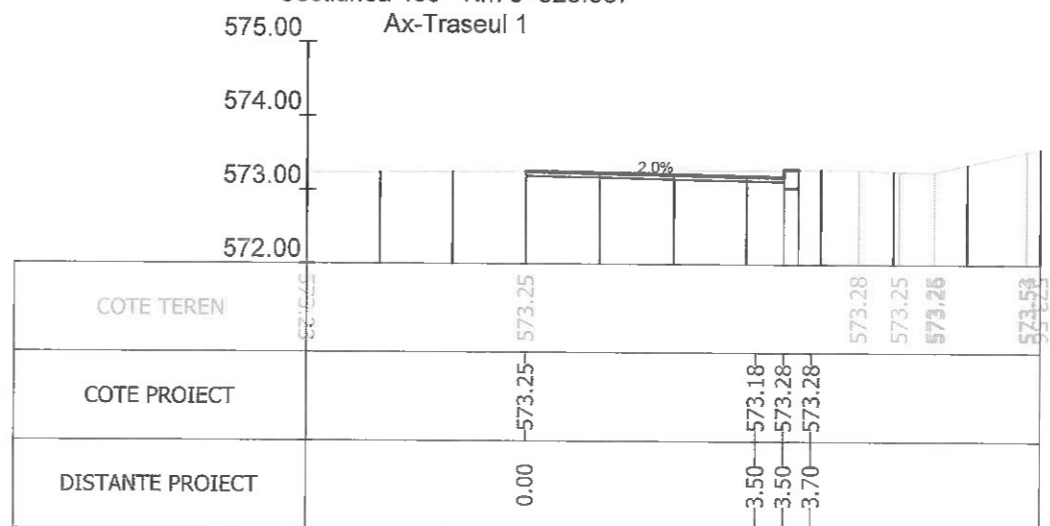

Sectiunea 408 - Km 5+545.393
Ax-Traseul 1

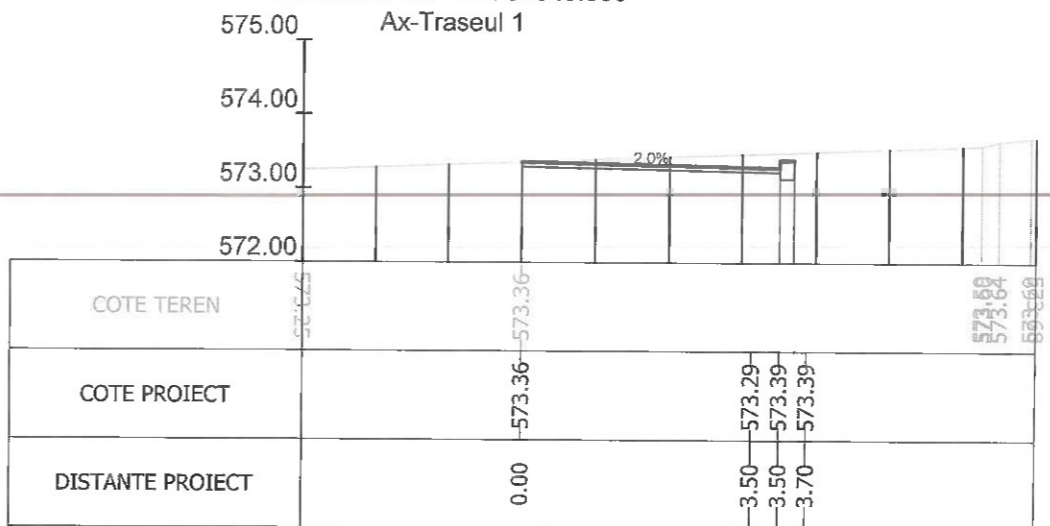

Sectiunea 409 - Km 5+549.266
Ax-Traseul 1

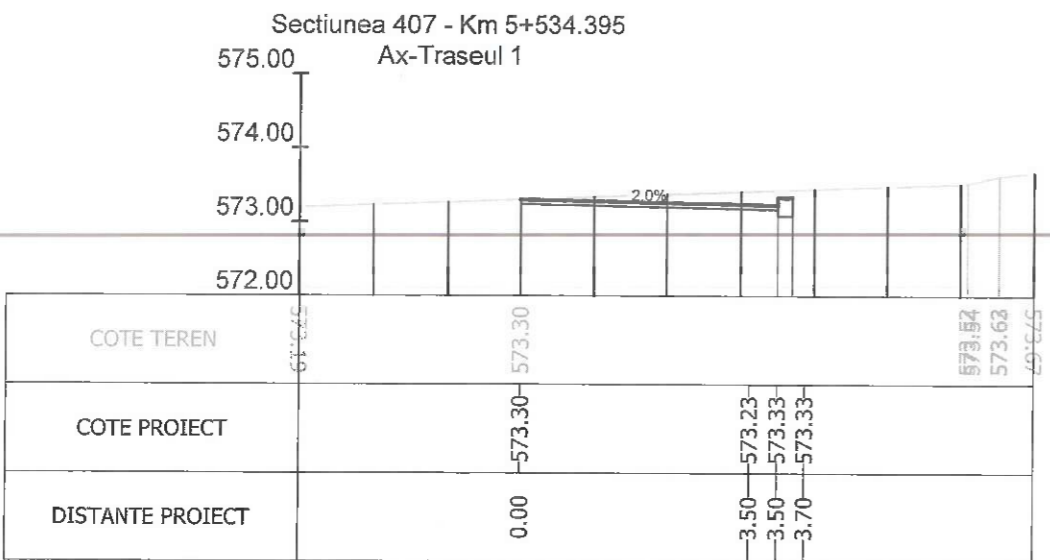

Sectiunea 410 - Km 5+550

Index	Data	Descriere	Rev. 5
A			
		Beneficiar:	MUNICIPIUL BRASOV Bulevardul Eroilor 8, Brasov 500007
Sef Proiect: Ing. A. Buta Proiectat: Ing. A. Buta Desenat: Ing. S. Patroi Verificat:		Titlu proiect:	AMENAJARE BENZI DEDICATE TRANSPORTULUI PUBLIC IN MUNICIPIUL BRASOV SI TROTUARE ADIACENTE
Scara: 1/100 Data: 07/2023		Titlu plansa:	PROFILE TRANSVERSALE CURENTE
		Nr. proiect	73 / 2020
		Faza P.T.	
		Nr. plansa	PT-57



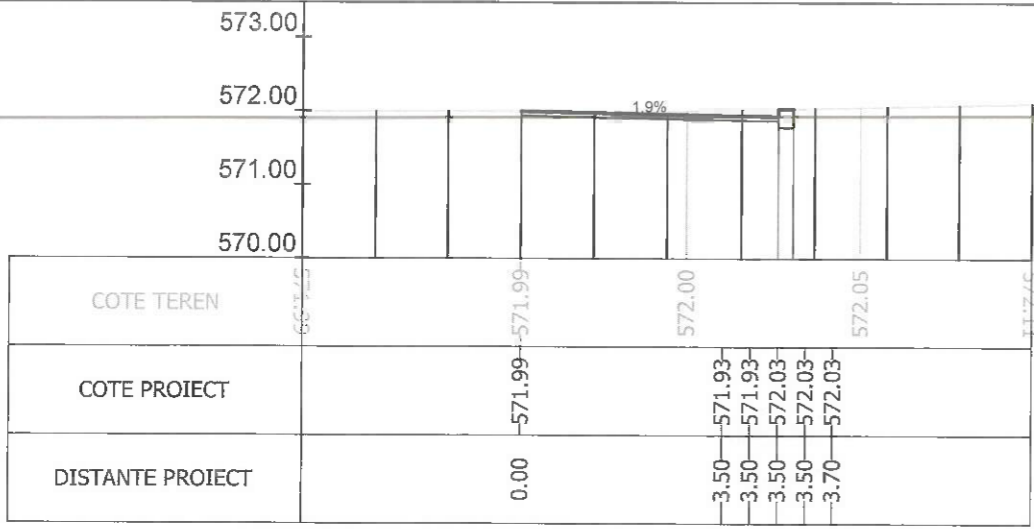

Sectiunea 417 - Km 5+616.216
Ax-Traseul 1

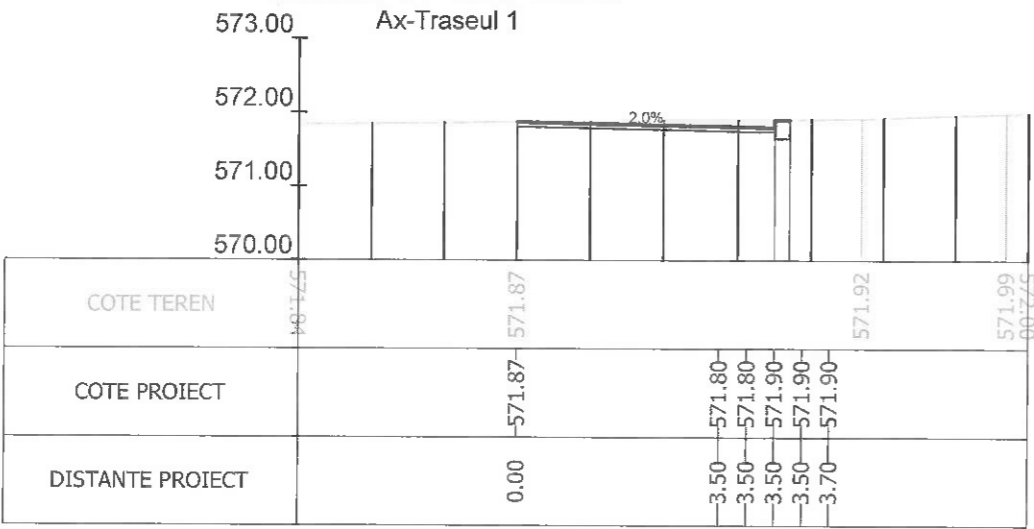

Sectiunea 419 - Km 5+625.756
Ax-Traseul 1

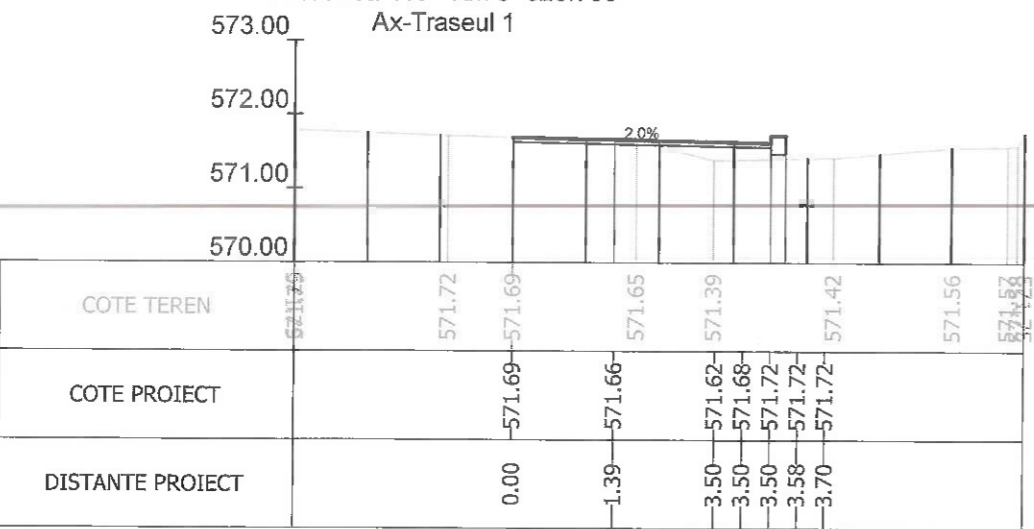

Sectiunea 421 - Km 5+650
Ax-Traseul 1

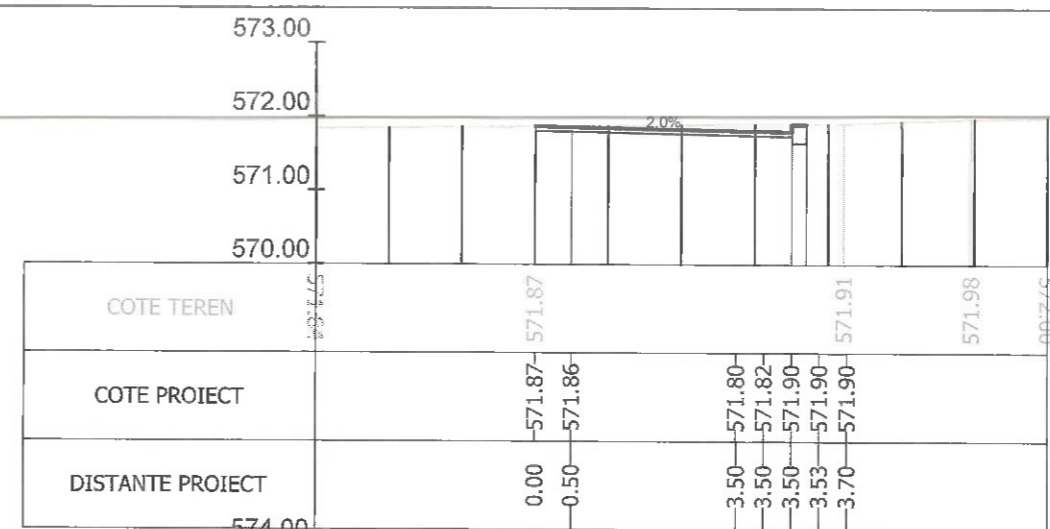

Sectiunea 418 - Km 5+625
Ax-Traseul 1

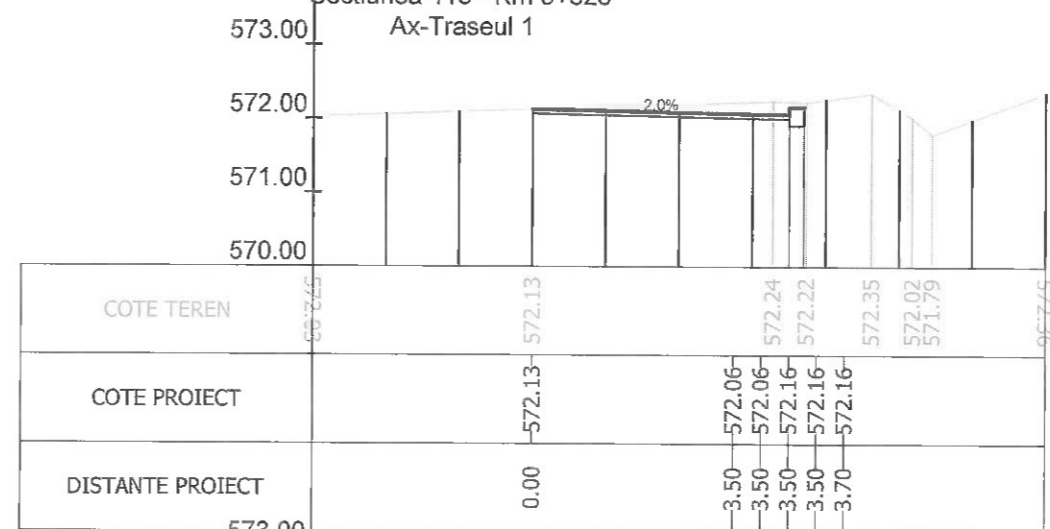

Sectiunea 420 - Km 5+642.120
Ax-Traseul 1

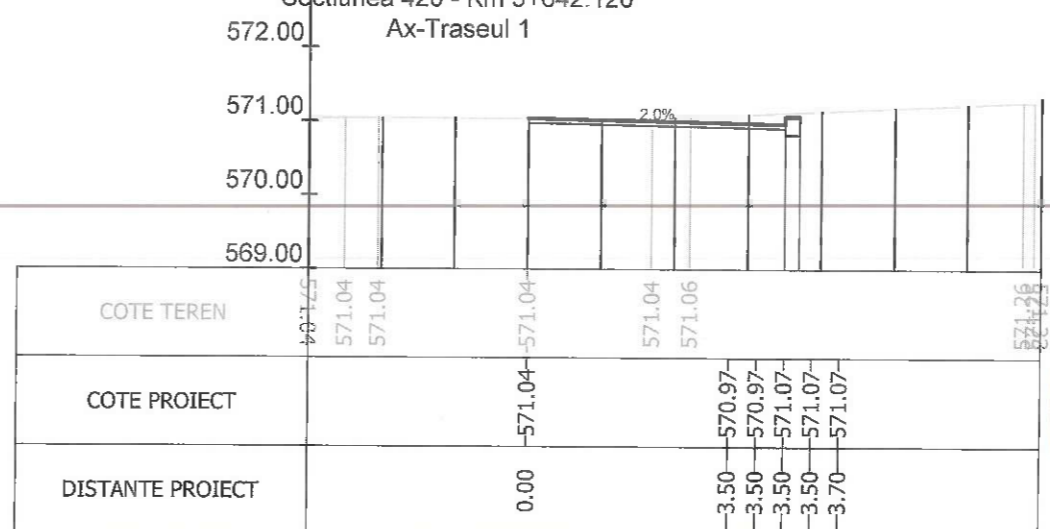

Sectiunea 422 - Km 5+669.782
Ax-Traseul 1



Index	Ax-Traceul 1		Rev. 5
A			
		Beneficiar:	MUNICIPIUL BRASOV Bulevardul Eroilor 8, Brasov 500007
<small>ROMANIA M.L.P.A. NR. 1414 INGINER VERIFICATOR PROIECTE</small>		Titlu proiect:	AMENAJARE BENZI DEDICATE TRANSPORTULUI PUBLIC IN MUNICIPIUL BRASOV SI TROTUARE ADIACENTE
<small>ROMANIA M.L.P.A. NR. 1414 INGINER VERIFICATOR PROIECTE</small>		Titlu plansa:	PROFILE TRANSVERSALE CURENTE
Sef Proiect	Ing. A. Buta	Scara	Nr. proiect 73 / 2020
Proiectat	Ing. A. Buta	1/100	Faza P.T.
Desenat	Ing. S. Patroi	Data	Nr. plansa PT-59
Verificat		07/2023	

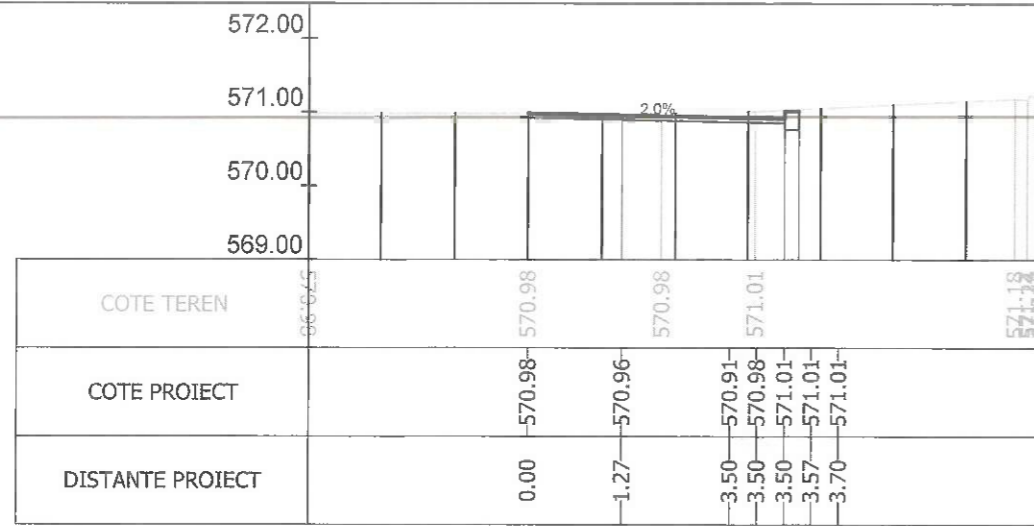

Sectiunea 423 - Km 5+675
Ax-Traseul 1

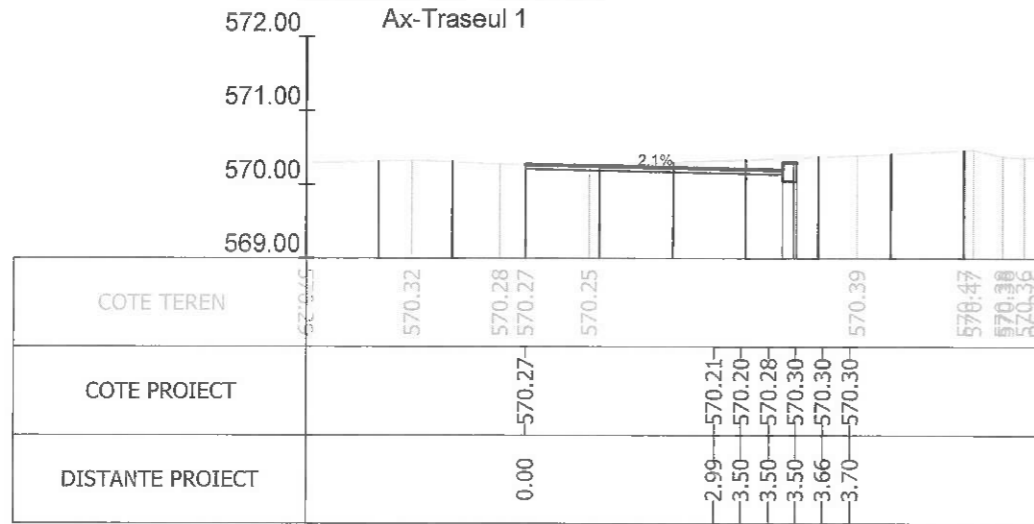

Sectiunea 425 - Km 5+719.664
Ax-Traseul 1

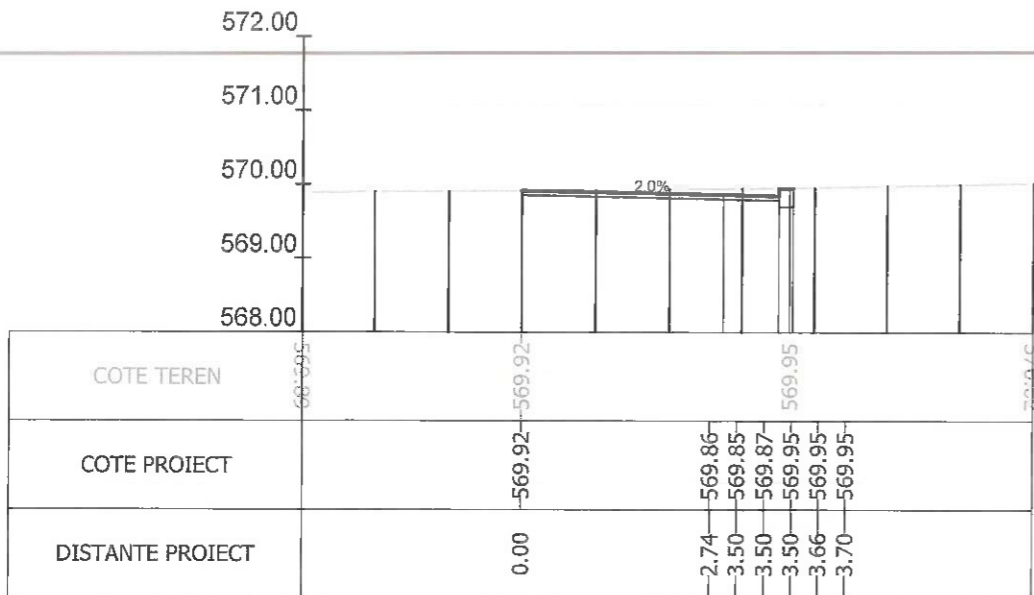

Sectiunea 427 - Km 5+750
Ax-Traseul 1

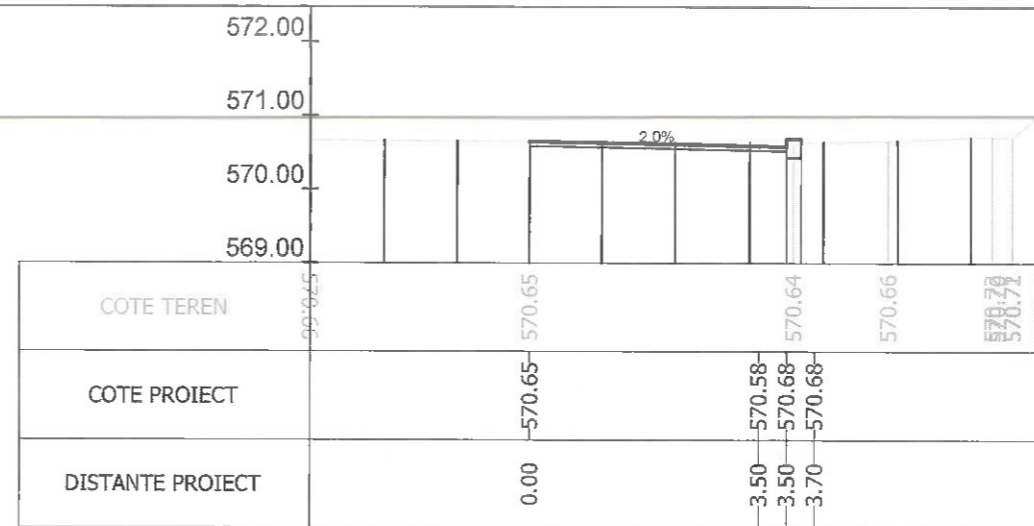

Sectiunea 424 - Km 5+700
Ax-Traseul 1

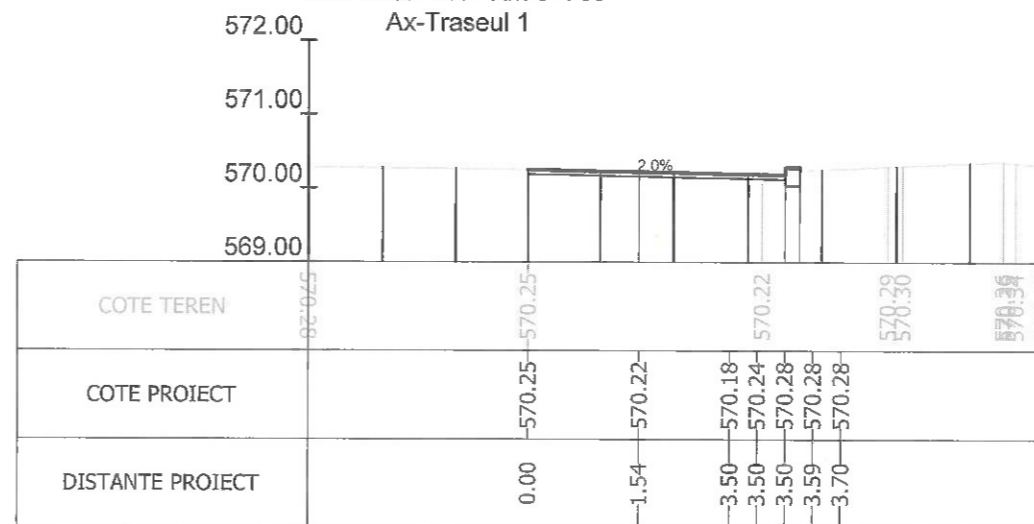

Sectiunea 426 - Km 5+725
Ax-Traseul 1

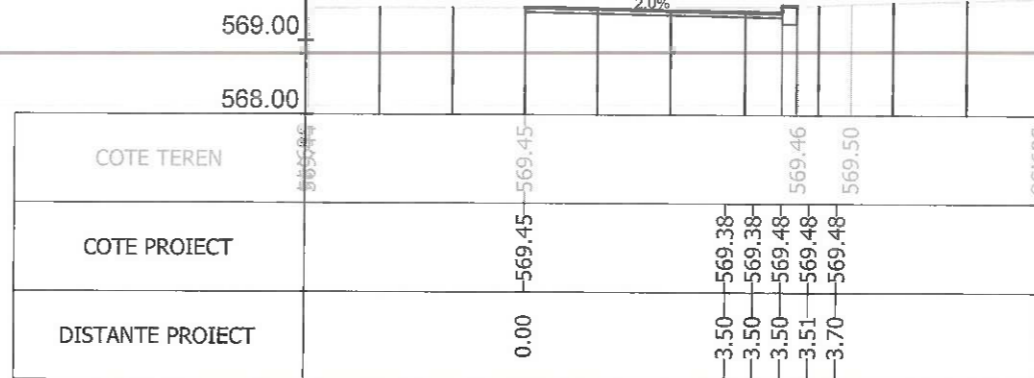

Sectiunea 428 - Km 5+770.571
Ax-Traseul 1

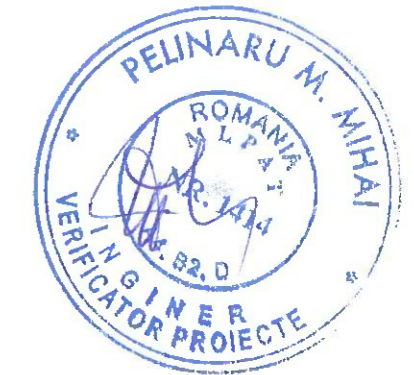

Index	A		Rev. 5
			Beneficiar:
Sef Proiect: Ing. A. Buta Proiectat: Ing. A. Buta Desenat: Ing. S. Patroi Verificat:			MUNICIPIUL BRASOV Bulevardul Eroilor 8, Brasov 500007
Scara: 1/100 Data: 07/2023			Nr. proiect: 73 / 2020 Faza: P.T. Nr. planşa: PT-60
Titlu proiect: AMENAJARE BENZI DEDICATE TRANSPORTULUI PUBLIC IN MUNICIPIUL BRASOV SI TROTUARE ADIACENTE			Titlu planşa: PROFILE TRANSVERSALE CURENTE

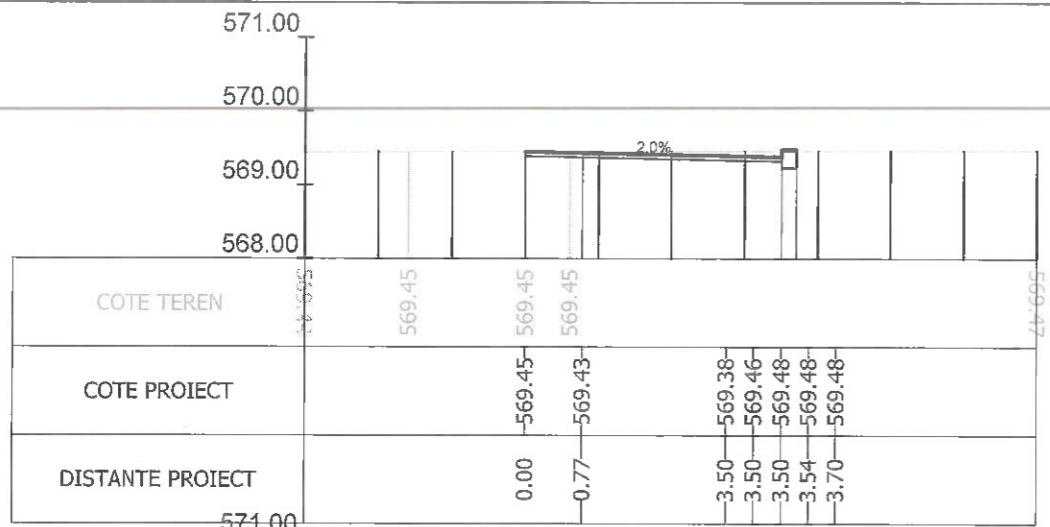

Sectiunea 429 - Km 5+775
Ax-Traseul 1

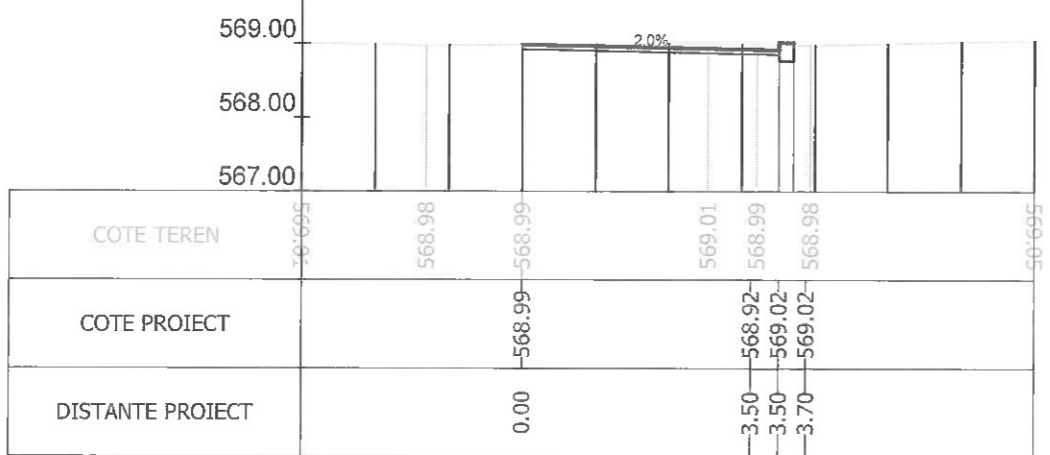

Sectiunea 431 - Km 5+800
Ax-Traseul 1

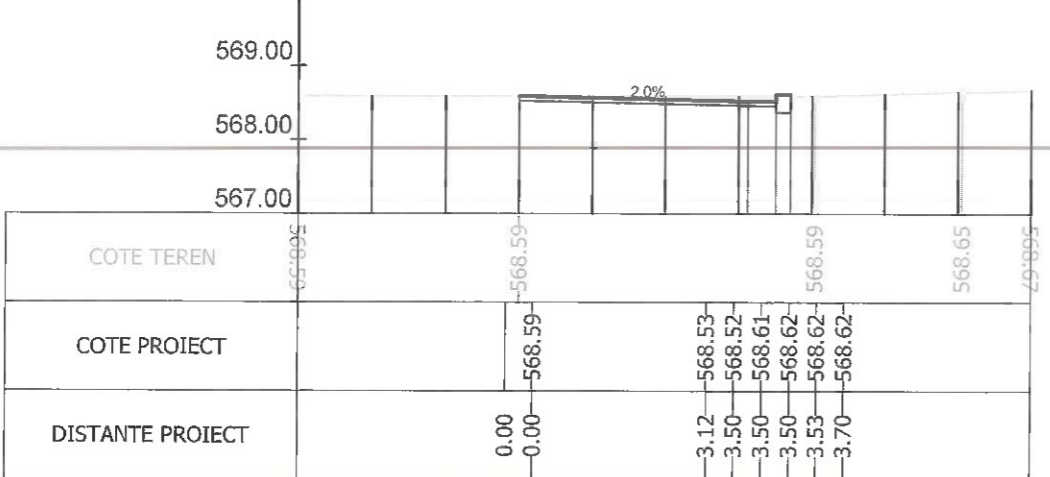

Sectiunea 433 - Km 5+825
Ax-Traseul 1

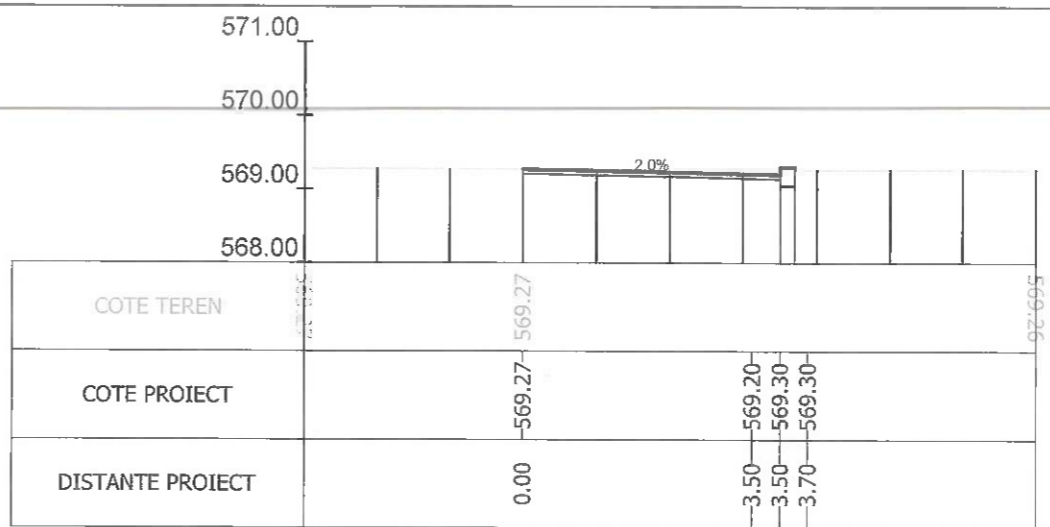

Sectiunea 430 - Km 5+790.250
Ax-Traseul 1

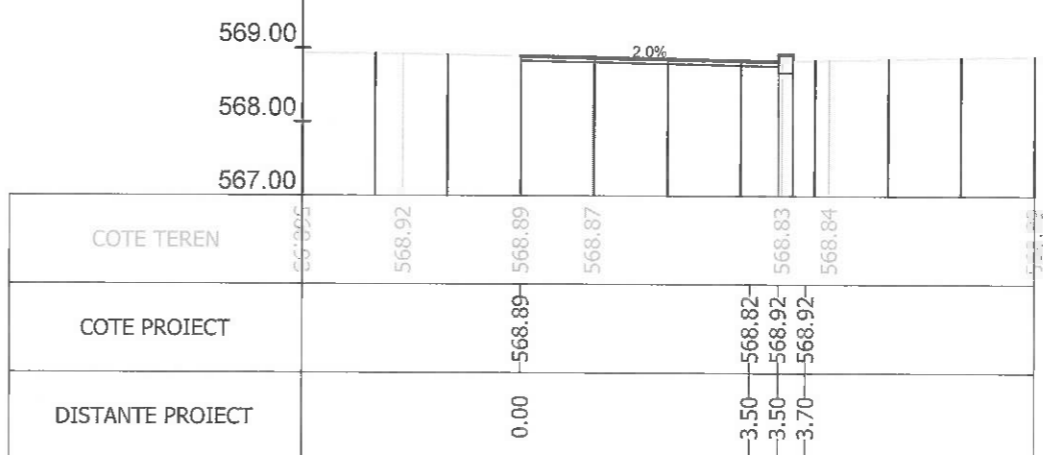

Sectiunea 432 - Km 5+810.126
Ax-Traseul 1

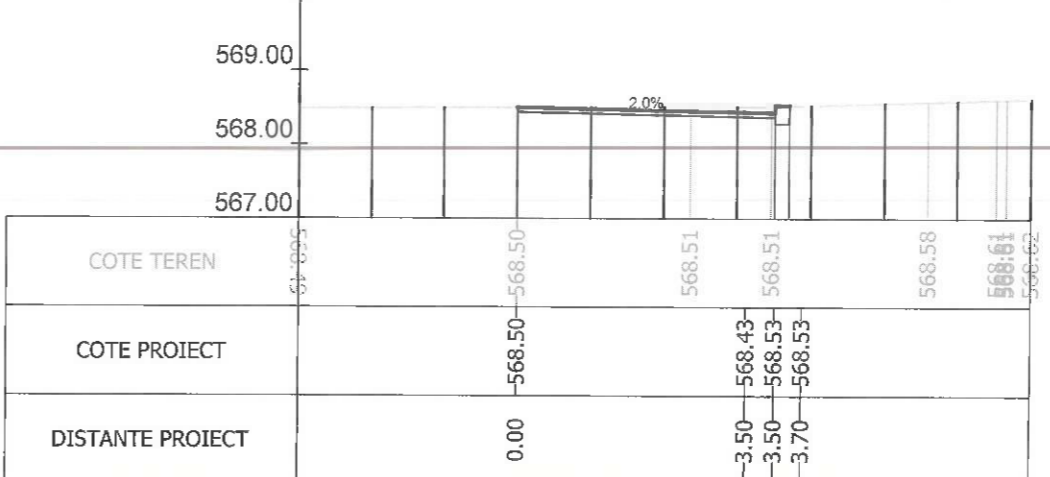

Sectiunea 434 - Km 5+830.002
Ax-Traseul 1

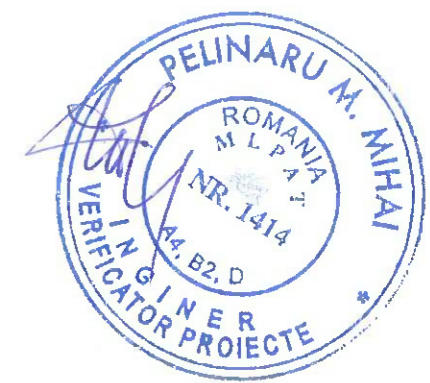

Index	A		Rev. 5
			Beneficiar: MUNICIPIUL BRASOV Bulevardul Eroilor 8, Brasov 500007
Sef Proiect	Ing. A. Buta	Scara	Nr. proiect
Proiectat	Ing. A. Buta	1/100	73 / 2020
Desenat	Ing. S. Patroi	Data	Faza
Verificat		07/2023	P.T.
			Tytu proiect: AMENAJARE BENZI DEDICATE TRANSPORTULUI PUBLIC IN MUNICIPIUL BRASOV SI TROTUARE ADIACENTE
			Tytu plansa: PROFILE TRANSVERSALE CURENTE
			Nr. plansa PT-61

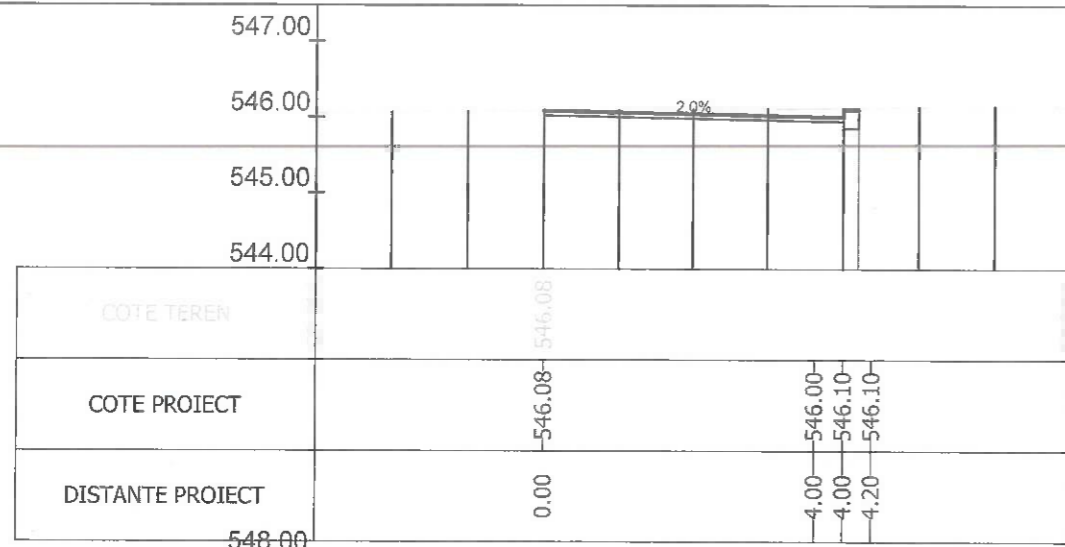

Sectiunea 3 - Km 0+050
Ax-Traseul 2

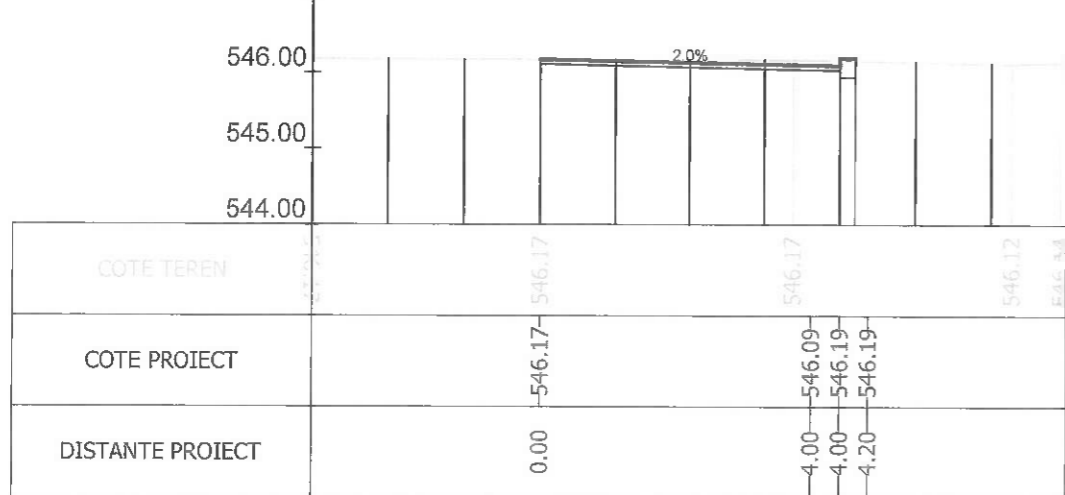

Sectiunea 5 - Km 0+075
Ax-Traseul 2

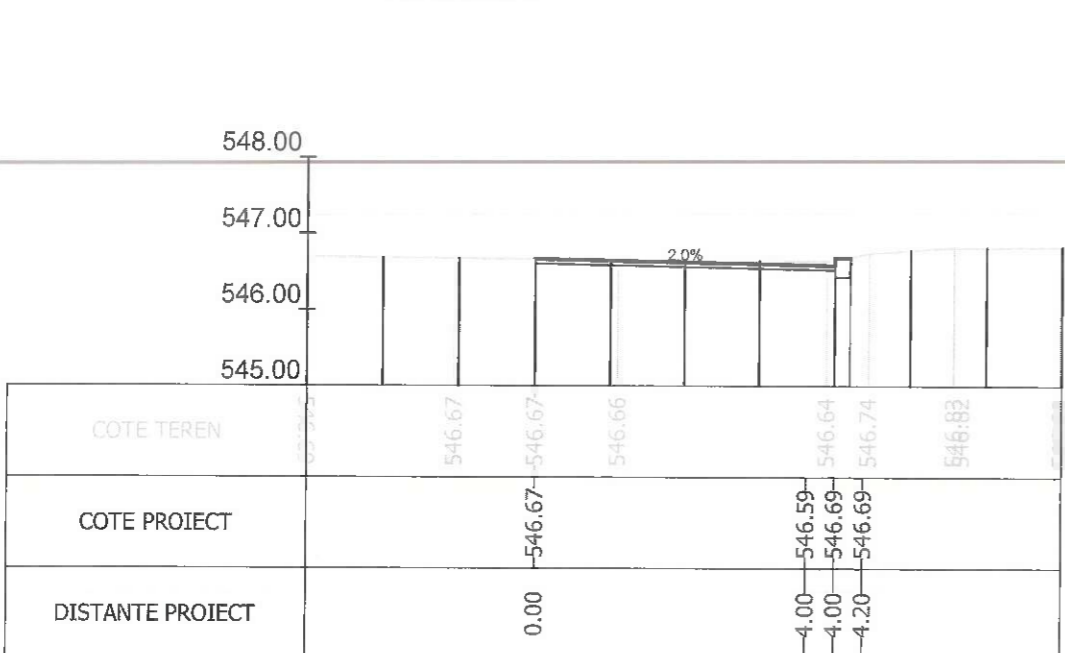

Sectiunea 7 - Km 0+125
Ax-Traseul 2

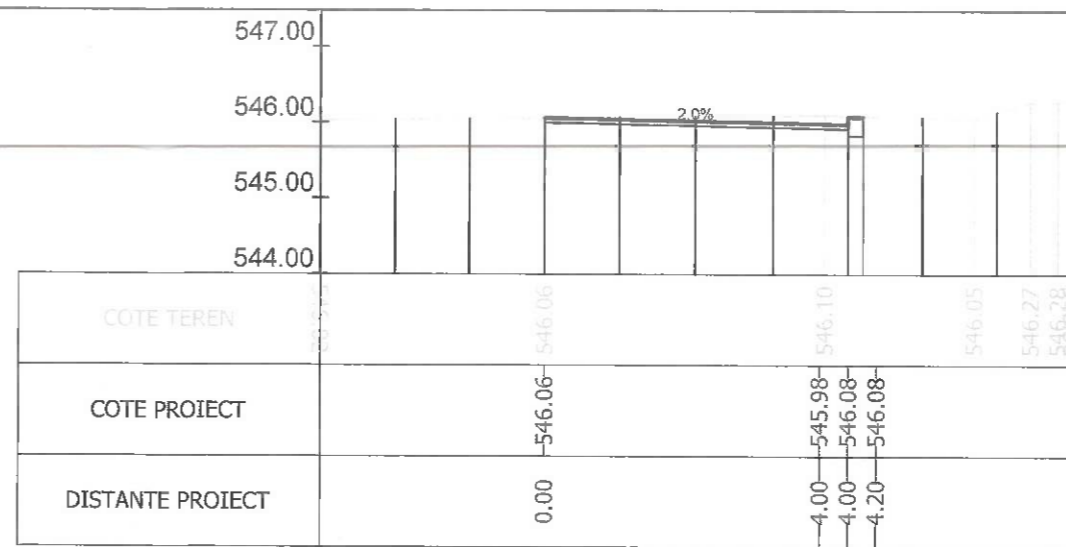

Sectiunea 4 - Km 0+063.802
Ax-Traseul 2

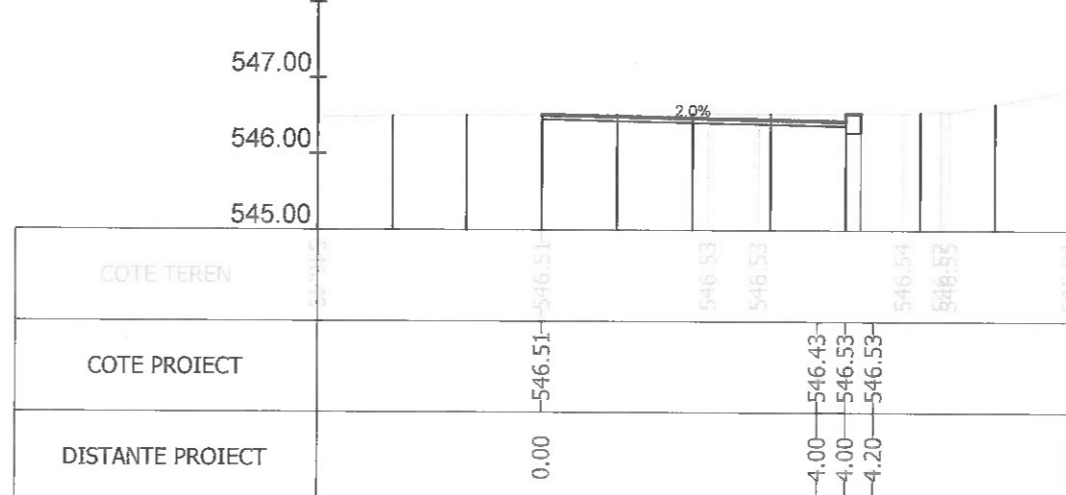

Sectiunea 6 - Km 0+100
Ax-Traseul 2

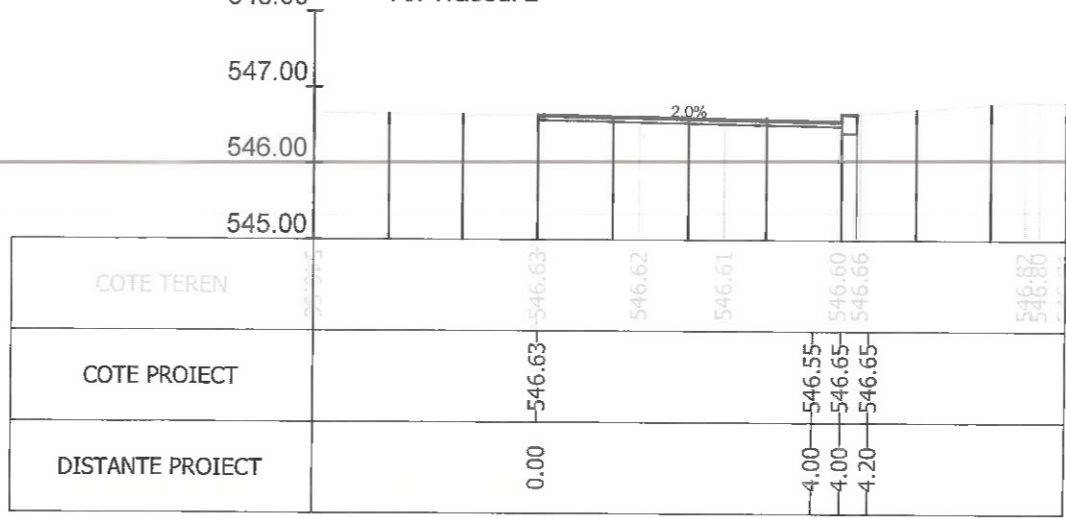

Sectiunea 8 - Km 0+127.604
Ax-Traseul 2



Index	A		Rev. 5
Beneficiar:		MUNICIPIUL BRASOV Bulevardul Eroilor 8, Brasov 500007	Nr. proiect 73 / 2020
Titlu proiect:		AMENAJARE BENZI DEDICATE TRANSPORTULUI PUBLIC IN MUNICIPIUL BRASOV SI TROTUARE ADIACENTE	Faza P.T.
Titlu plansa:		PROFILE TRANSVERSALE CURENTE	Nr. plansa PT-62
Sef Proiect	Ing. A. Buta	Scara	
Proiectat	Ing. A. Buta	1/100	
Desenat	Ing. S. Patroi	Data	
Verificat		07/2023	

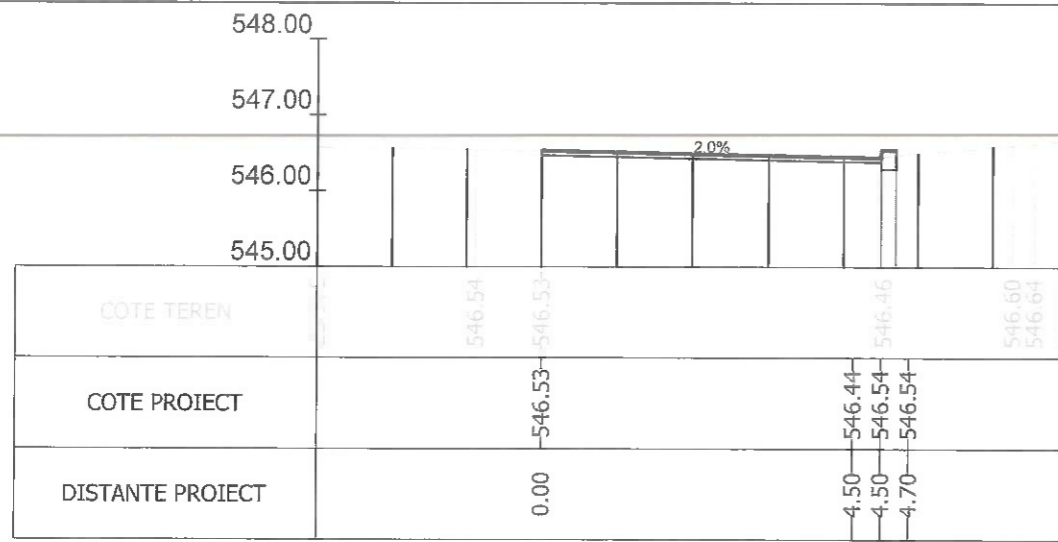

Sectiunea 12 - Km 0+148.927

Ax-Traseul 2

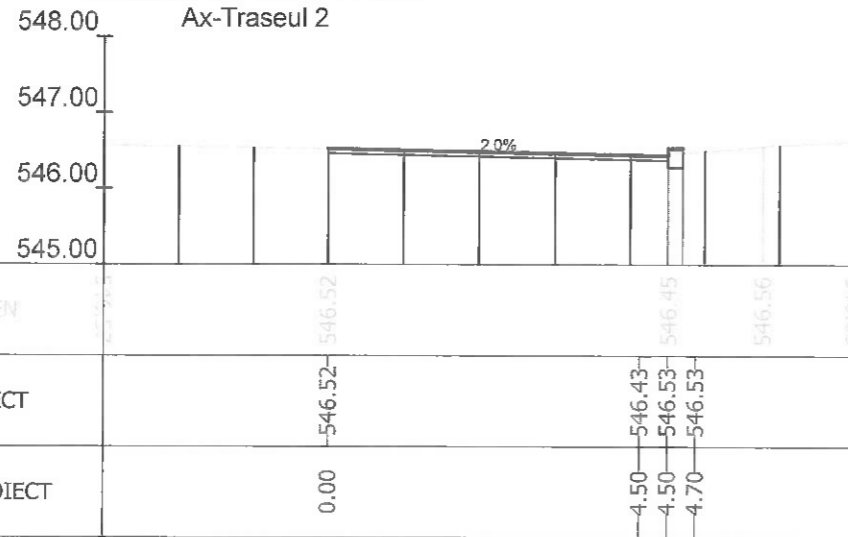

Sectiunea 14 - Km 0+151.794

Ax-Traseul 2

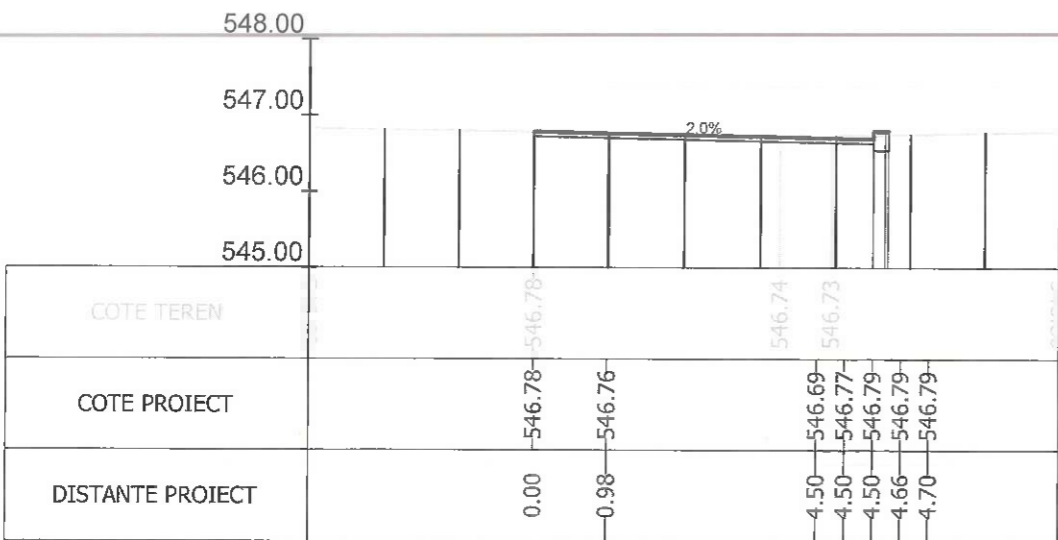

Sectiunea 16 - Km 0+175

Ax-Traseul 2

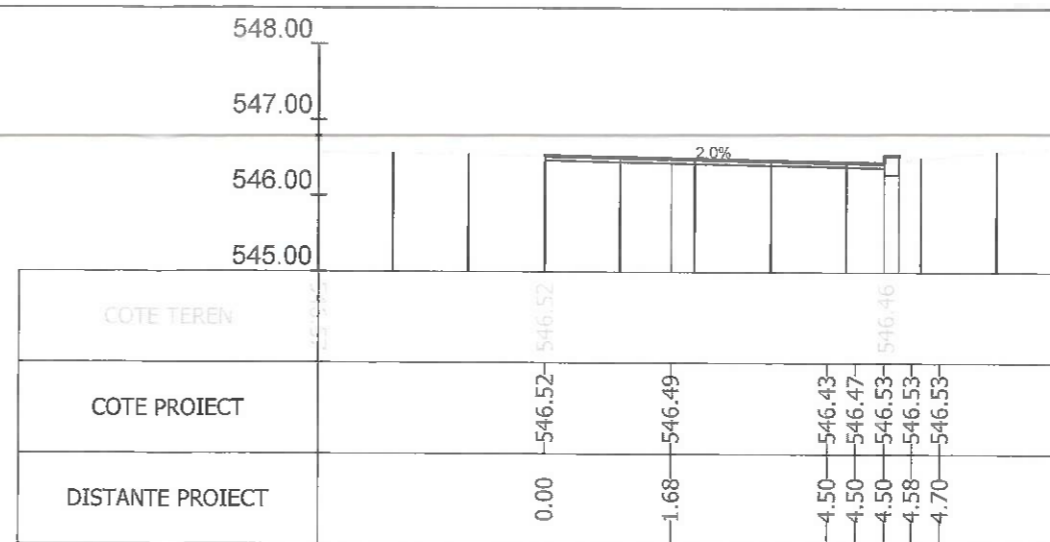

Sectiunea 13 - Km 0+150

Ax-Traseul 2

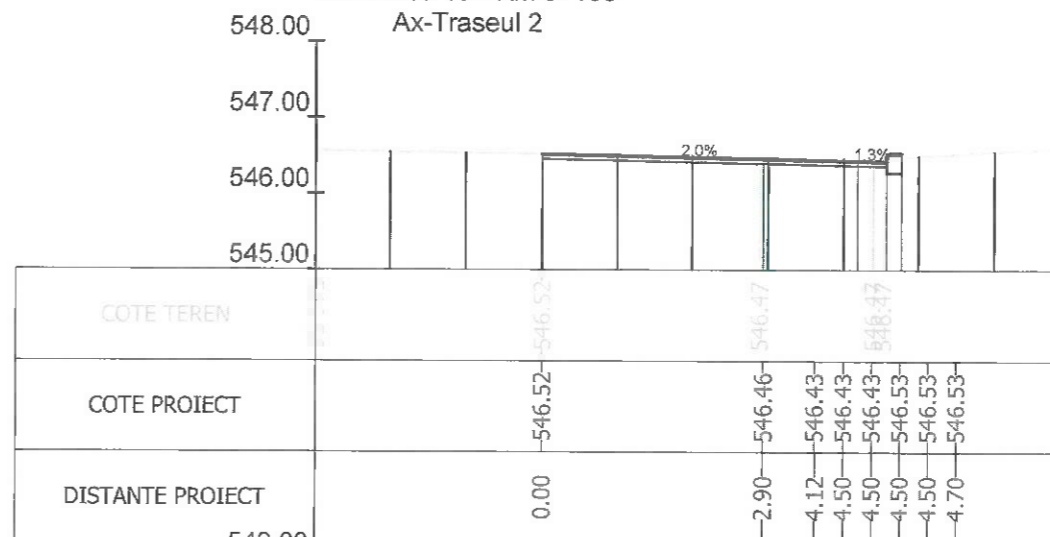

Sectiunea 15 - Km 0+153.971

Ax-Traseul 2

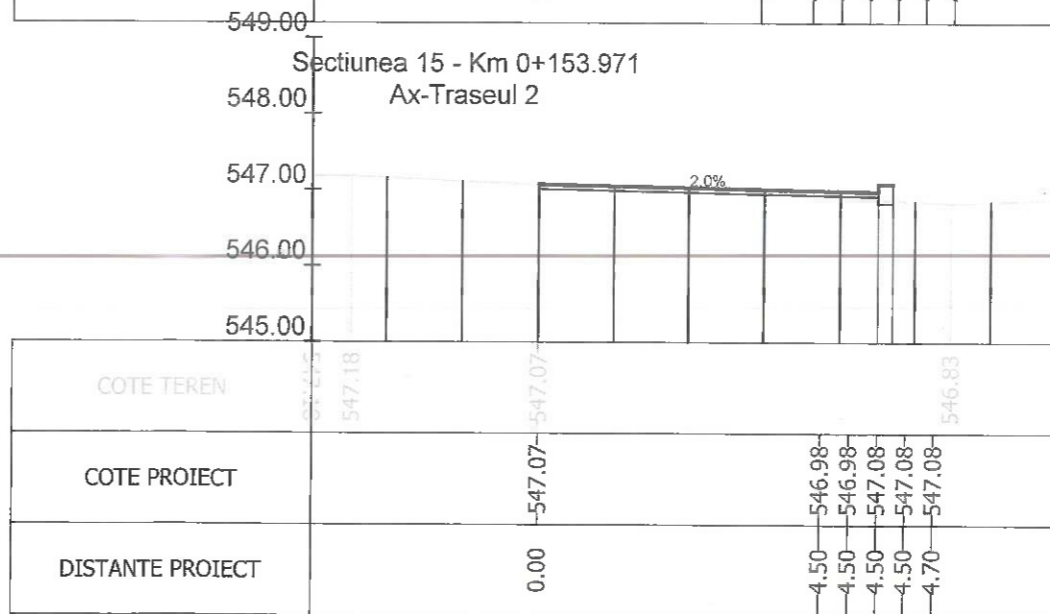

Sectiunea 17 - Km 0+184.280

Index	Data	Rev. 5
A		

HENTZA BUSINESS
www.hentza.ro

Sef Proiect: Ing. A. Buta
Proiectat: Ing. A. Buta
Desenat: Ing. S. Patroiu
Verificat:

Scara: 1/100
Data: 07/2023

Beneficiar:	MUNICIPIUL BRASOV Bulevardul Eroilor 8, Brasov 500007	Nr. proiect 73 / 2020
Titlu proiect:	AMENAJARE BENZI DEDICATE TRANSPORTULUI PUBLIC IN MUNICIPIUL BRASOV SI TROTUARE ADIACENTE	Faza P.T.
Titlu planşa:	PROFILE TRANSVERSALE CURENTE	Nr. planşa PT-63



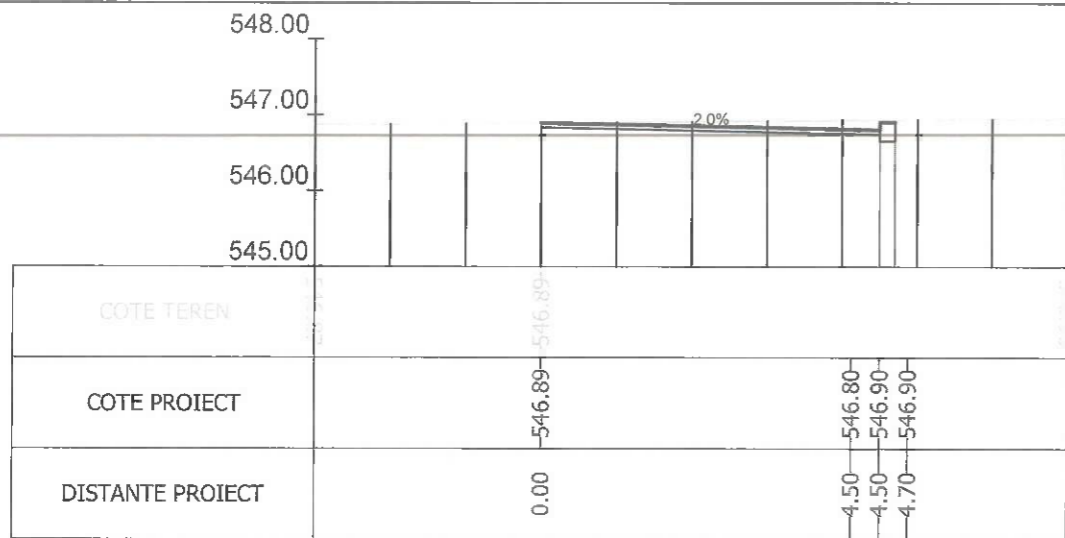

Sectiunea 18 - Km 0+200
Ax-Traseul 2

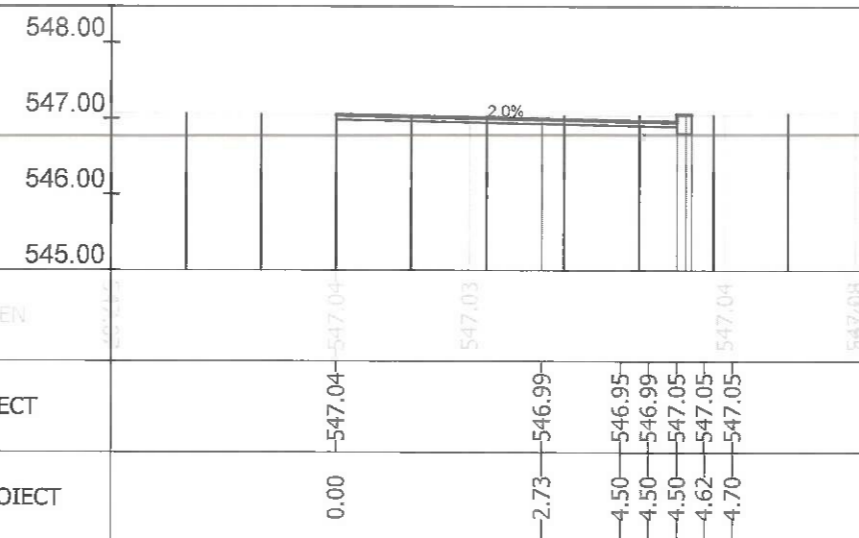
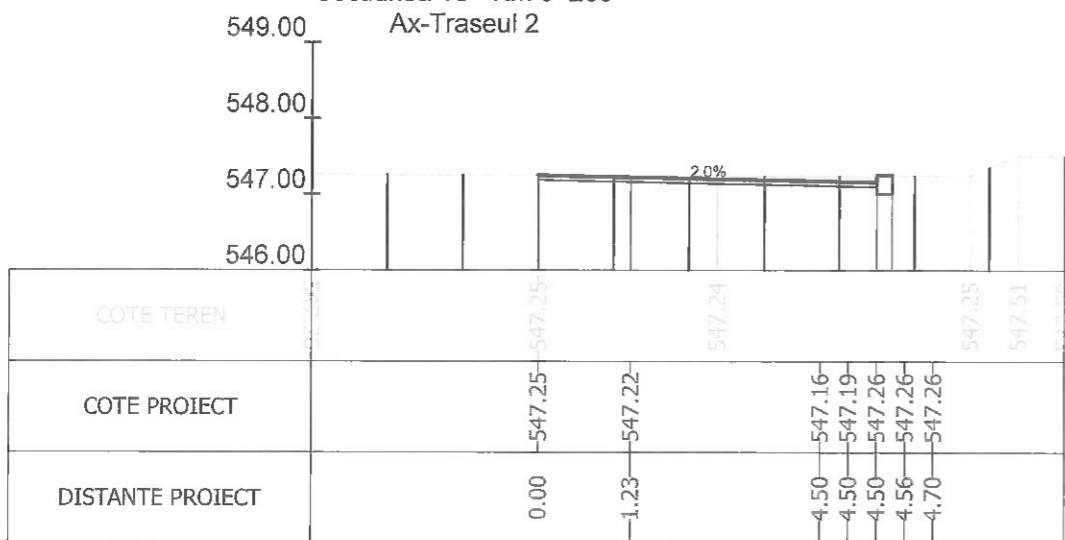

Sectiunea 19 - Km 0+225
Ax-Traseul 2

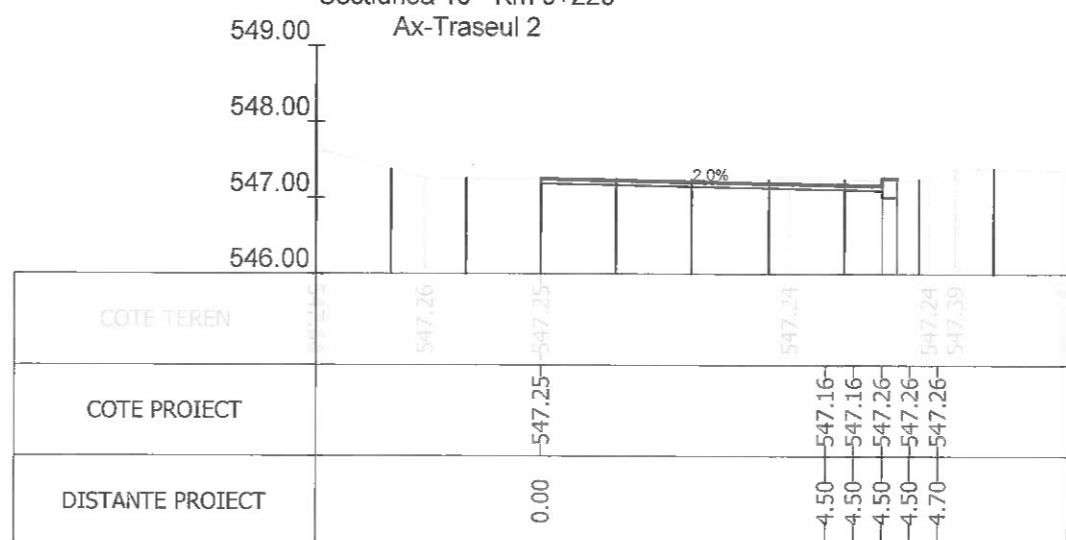

Sectiunea 20 - Km 0+250
Ax-Traseul 2

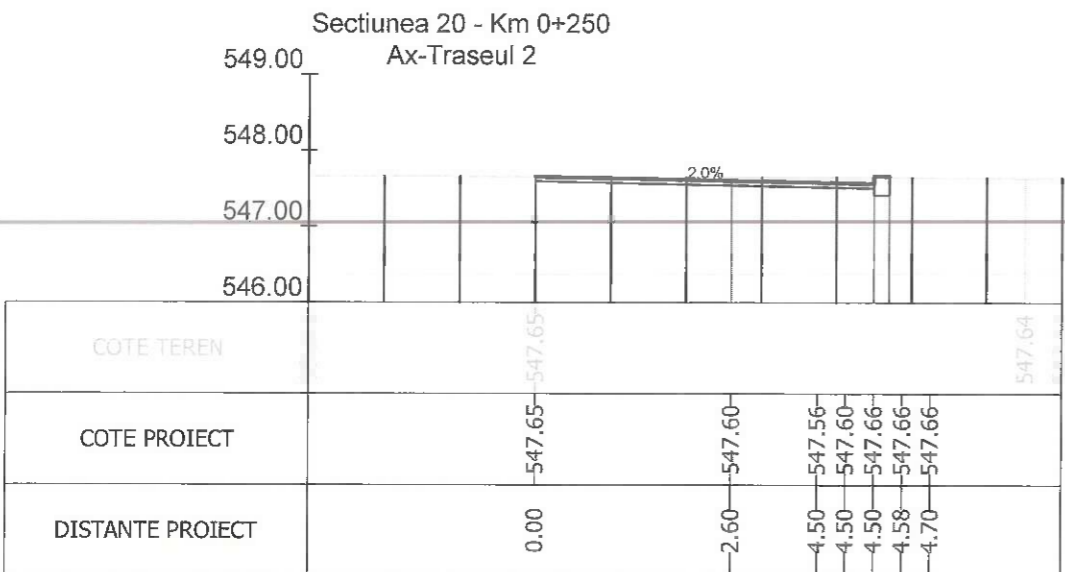

Sectiunea 21 - Km 0+250.899
Ax-Traseul 2

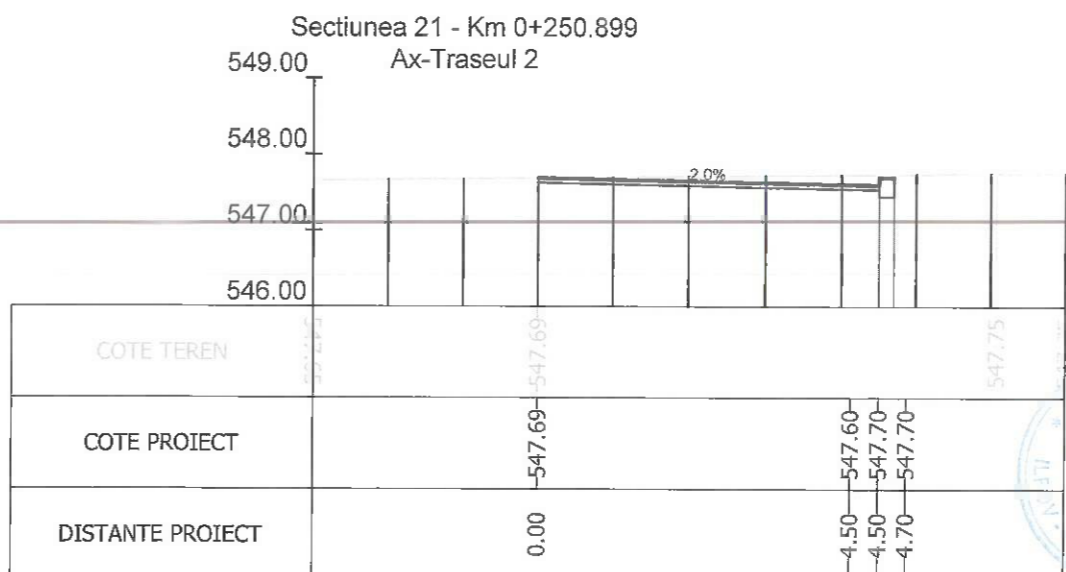

Sectiunea 22 - Km 0+275
Ax-Traseul 2

Index	A		Rev. 5
			
Beneficiar:	MUNICIPIUL BRASOV Bulevardul Eroilor 8, Brasov 500007		Nr. proiect 73 / 2020
Titlu proiect:	AMENAJARE BENZI DEDICATE TRANSPORTULUI PUBLIC IN MUNICIPIUL BRASOV SI TROTUARE ADIACENTE		Faza P.T.
Titlu plansa:	PROFILE TRANSVERSALE CURENTE		Nr. plansa PT-64
Sef Proiect	Ing. A. Buta	Scara	1/100
Proiectat	Ing. A. Buta	Data	07/2023
Desenat	Ing. S. Patroi		
Verificat			

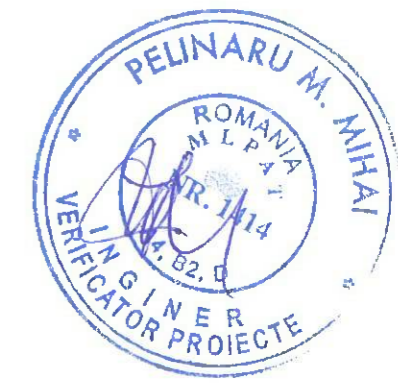

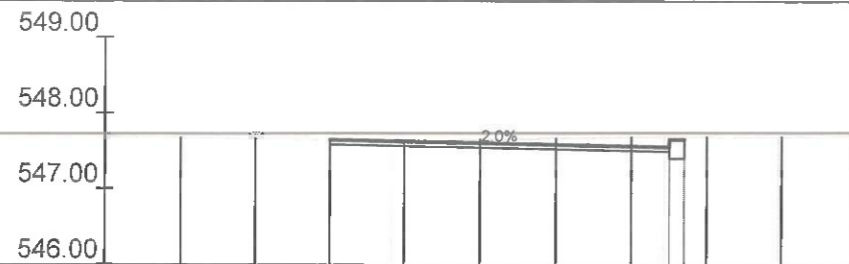

COTE TEREN										
COTE PROIECT										
DISTANTE PROIECT	0.00					4.50	4.50	4.70		

Sectiunea 24 - Km 0+300
Ax-Traseul 2

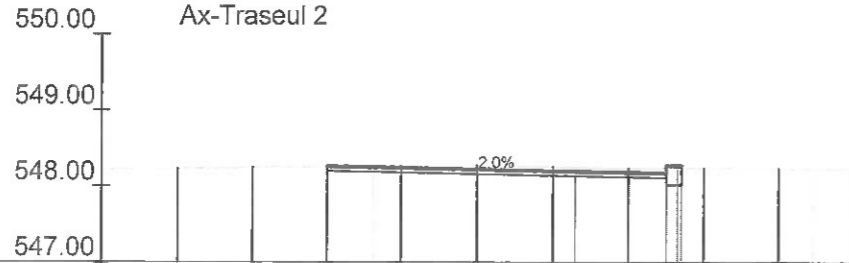

COTE TEREN										
COTE PROIECT										
DISTANTE PROIECT	0.00					3.30	4.50	4.50	4.65	4.70

Sectiunea 26 - Km 0+350
Ax-Traseul 2

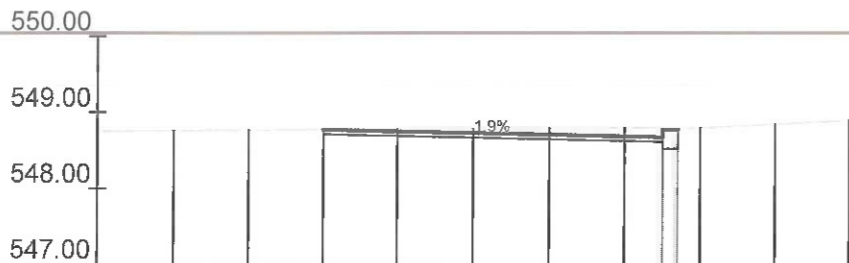

COTE TEREN										
COTE PROIECT										
DISTANTE PROIECT	0.00					4.50	4.50	4.50	4.70	

Sectiunea 28 - Km 0+375.436
Ax-Traseul 2

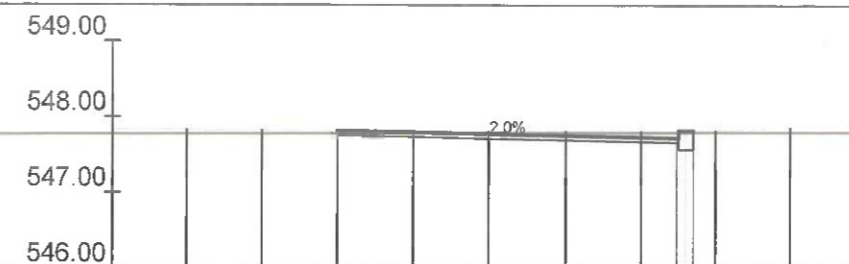

COTE TEREN										
COTE PROIECT										
DISTANTE PROIECT	0.00					4.48	4.50	4.50	4.70	

Sectiunea 25 - Km 0+325
Ax-Traseul 2

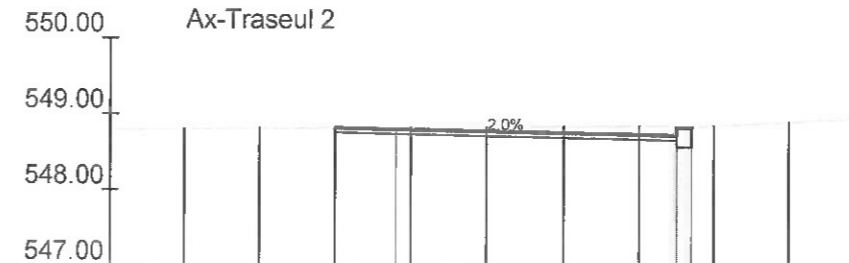

COTE TEREN										
COTE PROIECT										
DISTANTE PROIECT	0.00					0.80				

Sectiunea 27 - Km 0+375
Ax-Traseul 2

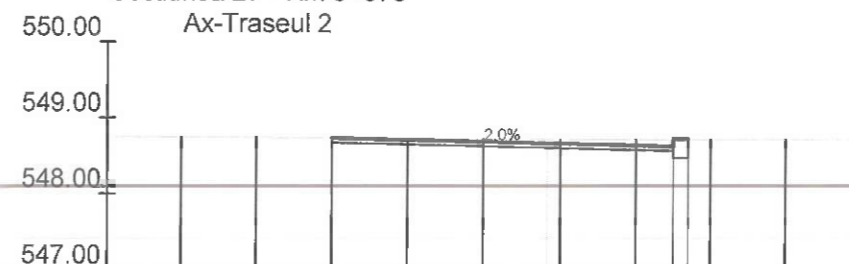

COTE TEREN										
COTE PROIECT										
DISTANTE PROIECT	0.00					4.50	4.50	4.70		

Sectiunea 29 - Km 0+400
Ax-Traseul 2

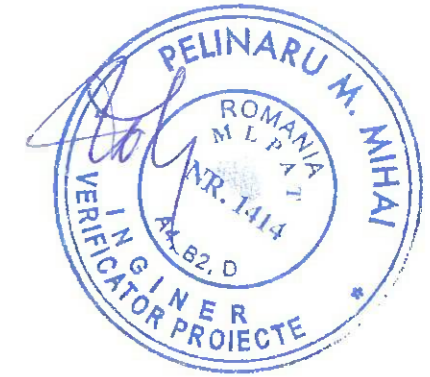

Index	Data		Rev. 5	
A	Ax-Traseul 2			
 www.hentza.ro			Beneficiar:	
			MUNICIPIUL BRASOV Bulevardul Eroilor 8, Brasov 500007	
Sef Proiect			Nr. proiect	
Proiectat			73 / 2020	
Desenat			Faza	
Verificat			P.T.	
			Titlu planşa:	
			Nr. planşa	
			PT-65	
Scara			Titlu proiect:	
1/100			AMENAJARE BENZI DEDICATE TRANSPORTULUI PUBLIC IN MUNICIPIUL BRASOV SI TROTUARE ADIACENTE	
Data			Titlu planşa:	
07/2023			PROFILE TRANSVERSALE CURENTE	

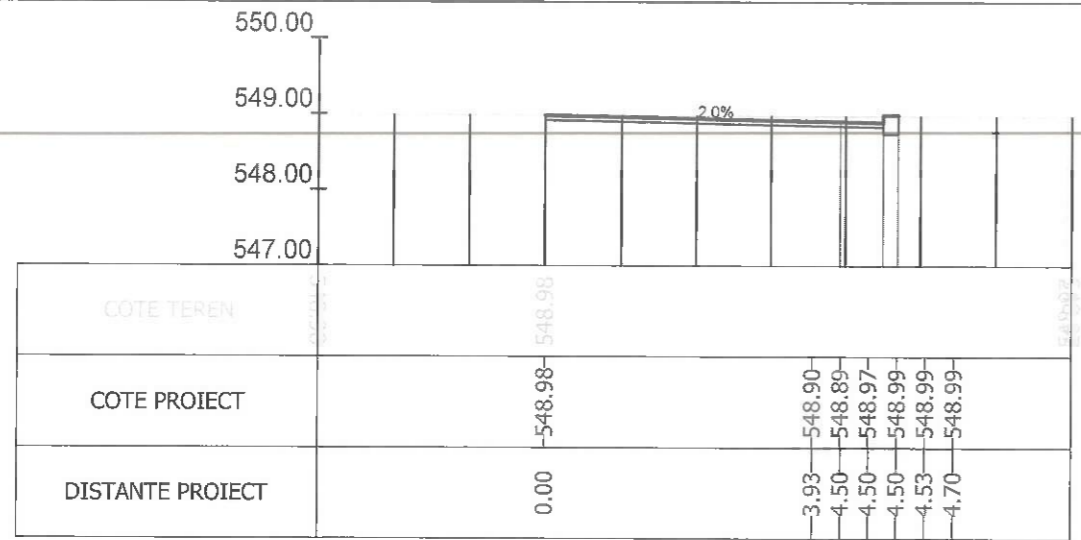

Sectiunea 30 - Km 0+425
Ax-Traseul 2

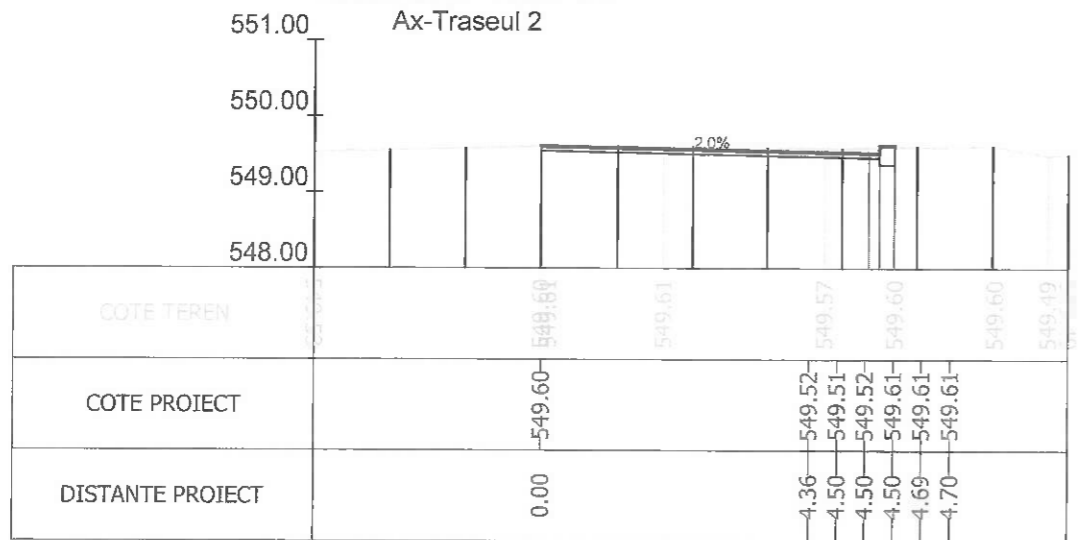

Sectiunea 32 - Km 0+475
Ax-Traseul 2

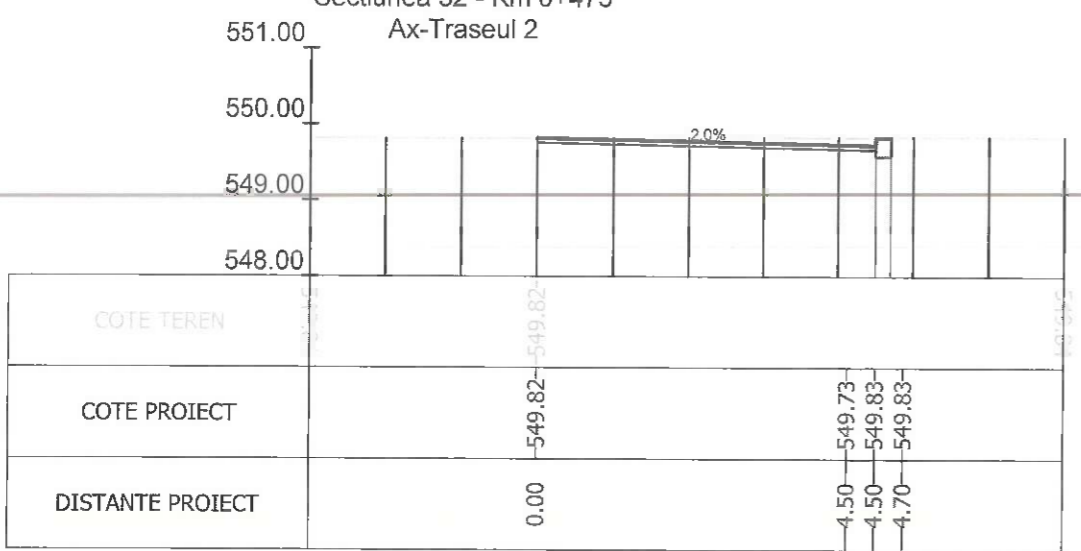

Sectiunea 34 - Km 0+500
Ax-Traseul 2

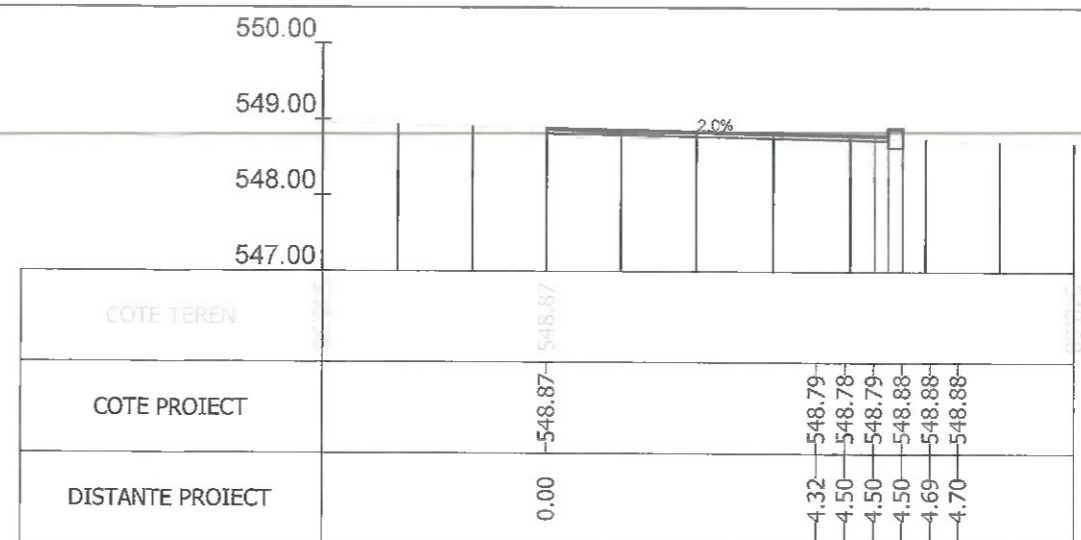

Sectiunea 31 - Km 0+450
Ax-Traseul 2

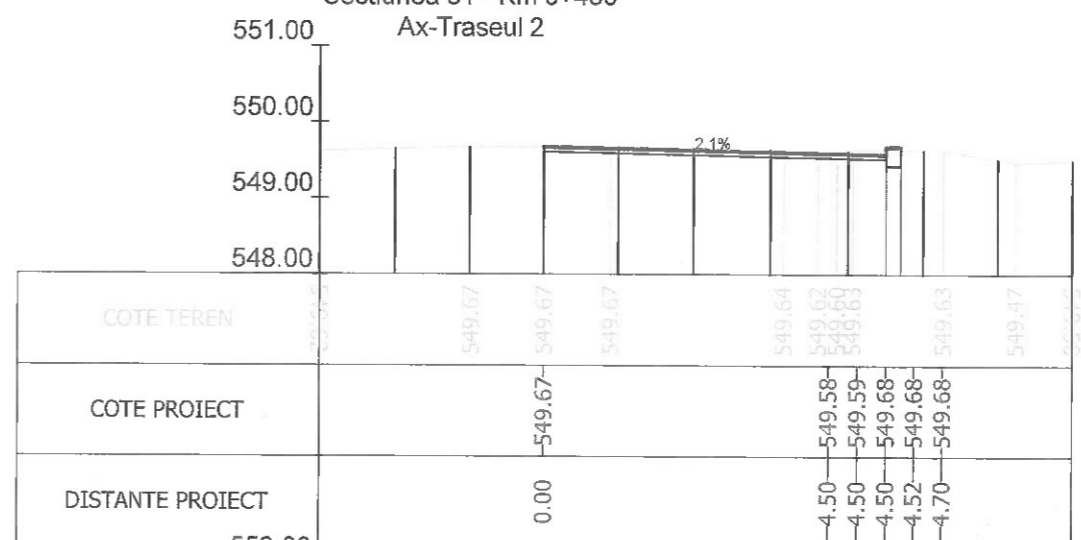

Sectiunea 33 - Km 0+476.228
Ax-Traseul 2

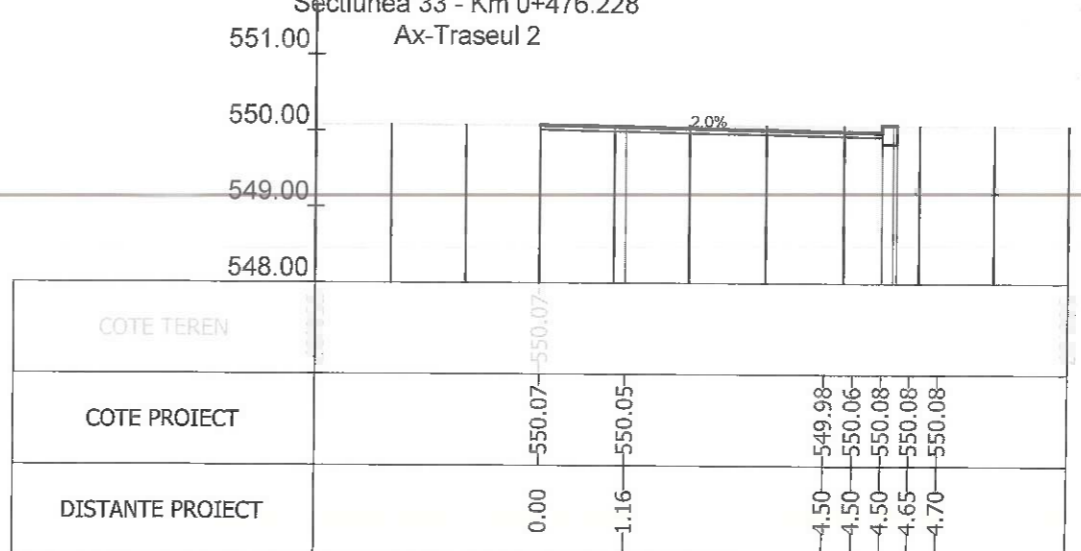

Sectiunea 35 - Km 0+525



Index	A		Rev. 5
HENTZA BUSINESS			
Beneficiar:		MUNICIPIUL BRASOV Bulevardul Eroilor 8, Brasov 500007	Nr. proiect 73 / 2020
Titlu proiect:		AMENAJARE BENZI DEDICATE TRANSPORTULUI PUBLIC IN MUNICIPIUL BRASOV SI TROTUARE ADIACENTE	Faza P.T.
Titlu plansa:		PROFILE TRANSVERSALE CURENTE	Nr. plansa PT-66
Sef Proiect	Ing. A. Buta	Scara 1/100	
Proiectat	Ing. A. Buta		
Desenat	Ing. S. Patroi	Data 07/2023	
Verificat			

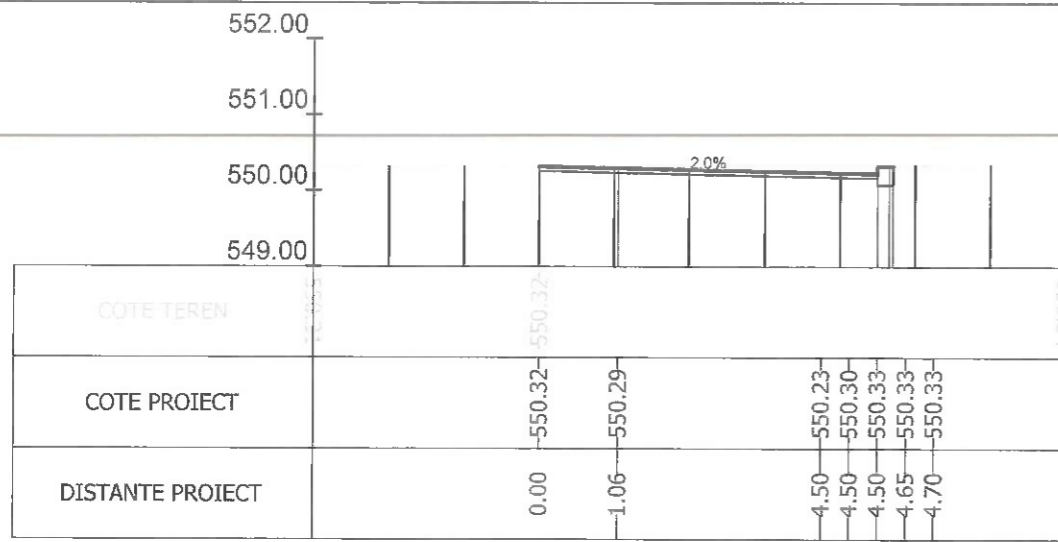

Sectiunea 36 - Km 0+550
Ax-Traseul 2

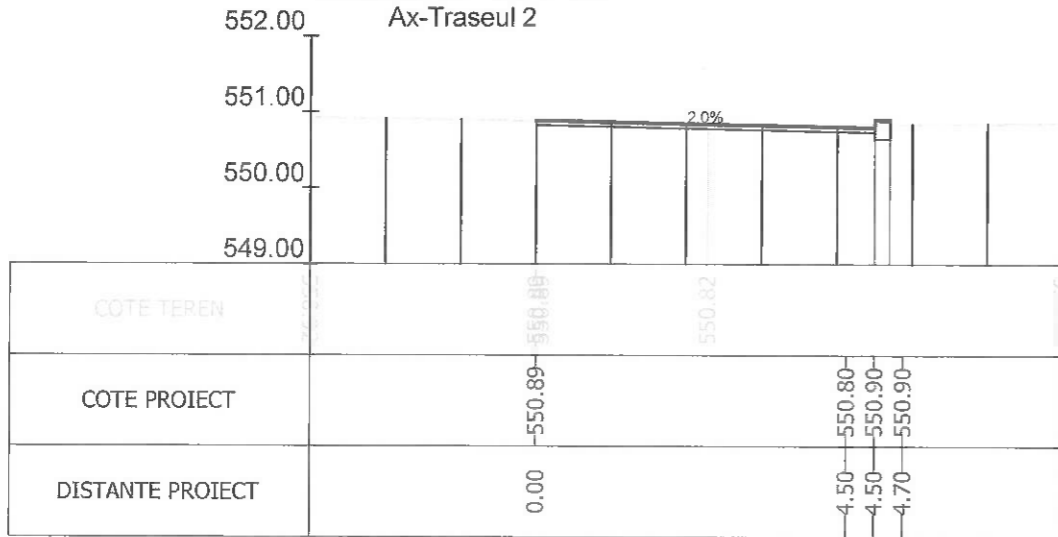

Sectiunea 38 - Km 0+600
Ax-Traseul 2

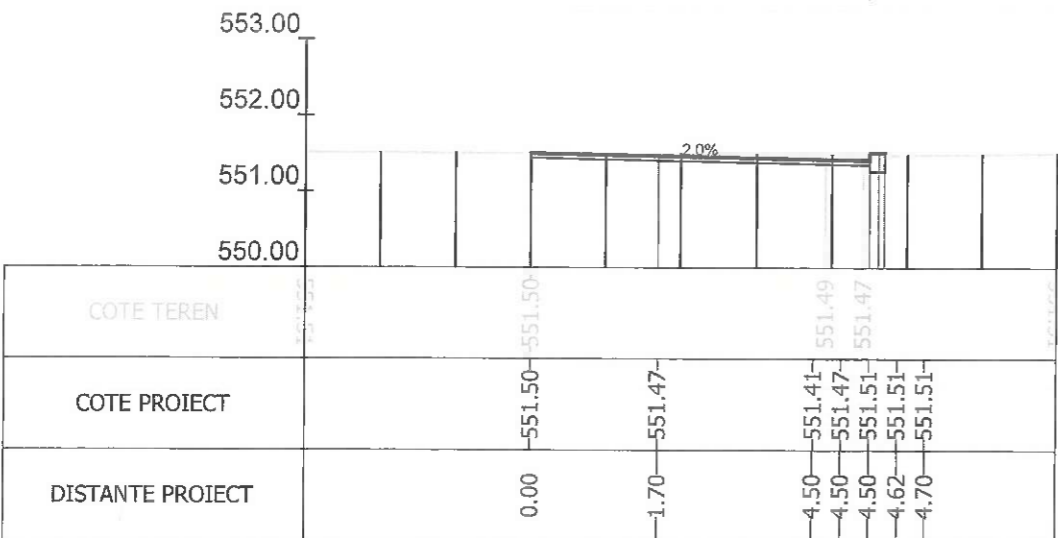

Sectiunea 40 - Km 0+650
Ax-Traseul 2

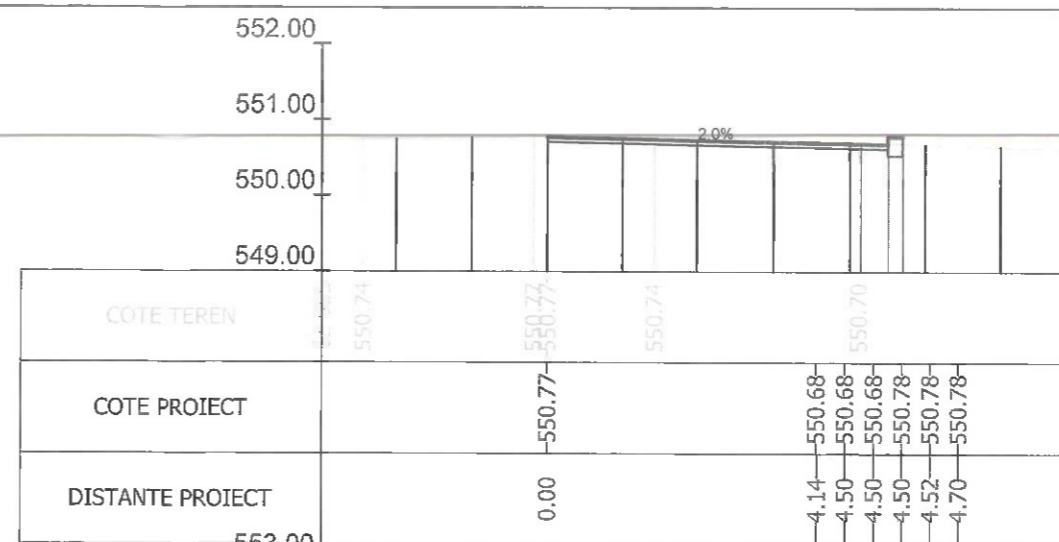

Sectiunea 37 - Km 0+575
Ax-Traseul 2

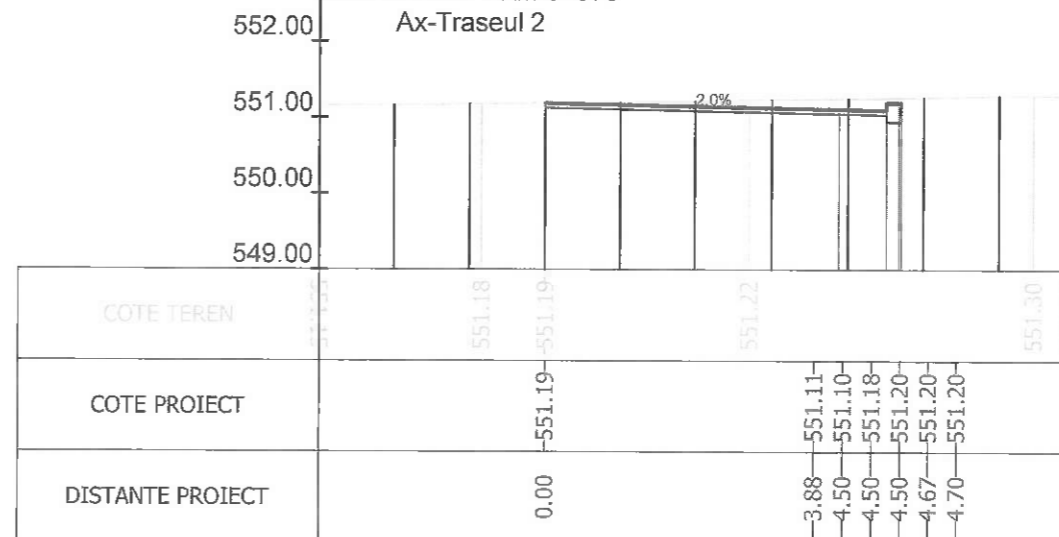

Sectiunea 39 - Km 0+625
Ax-Traseul 2

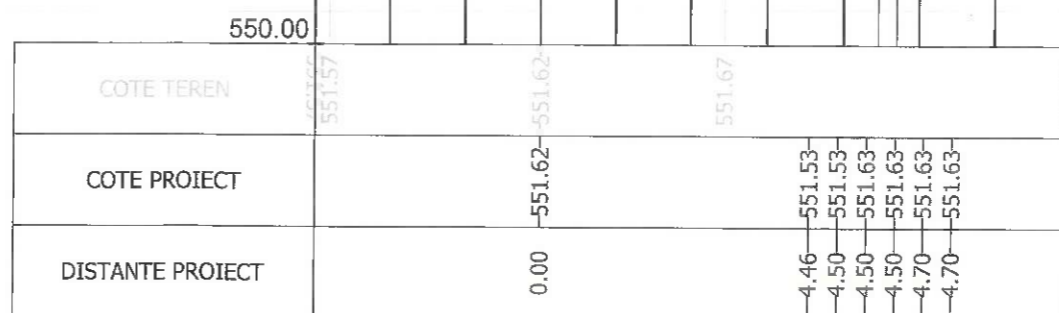

Sectiunea 41 - Km 0+665.170
Ax-Traseul 2

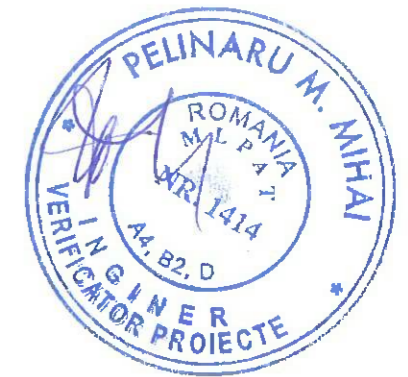

Index	Data	Observatii	Rev. 5
A			
		Beneficiar:	MUNICIPIUL BRASOV Bulevardul Eroilor 8, Brasov 500007
Sef Proiect	Ing. A. Buta	Titlu proiect:	AMENAJARE BENZI DEDICATE TRANSPORTULUI PUBLIC IN MUNICIPIUL BRASOV SI TROTUARE ADIACENTE
Proiectat	Ing. A. Buta	Titlu plansa:	PROFILE TRANSVERSALE CURENTE
Desenat	Ing. S. Patroi	Scara	1/100
Verificat		Data	07/2023
		Nr. proiect	73 / 2020
		Faza	P.T.
		Nr. plansa	PT-67

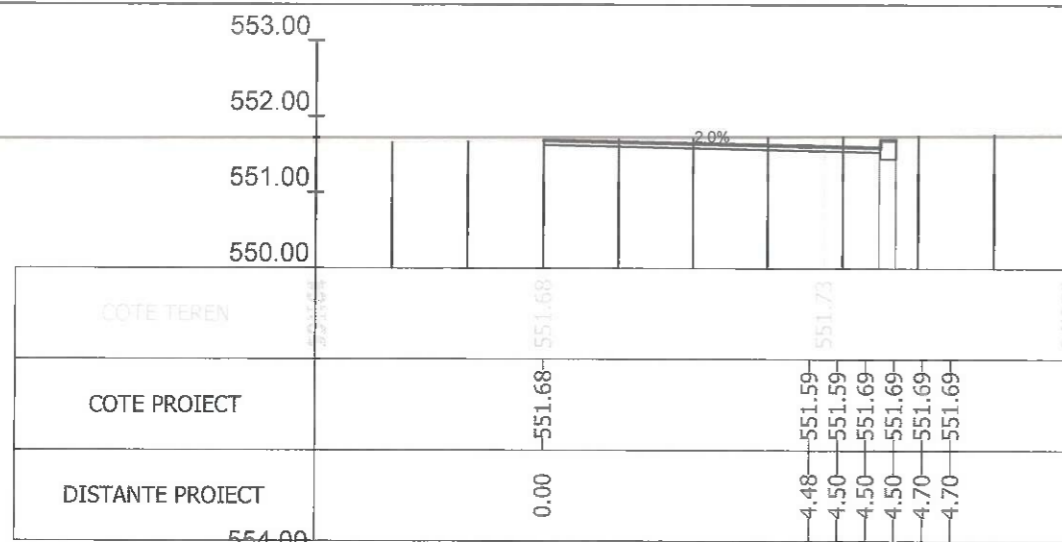

Sectiunea 42 - Km 0+669.469
Ax-Traseul 2

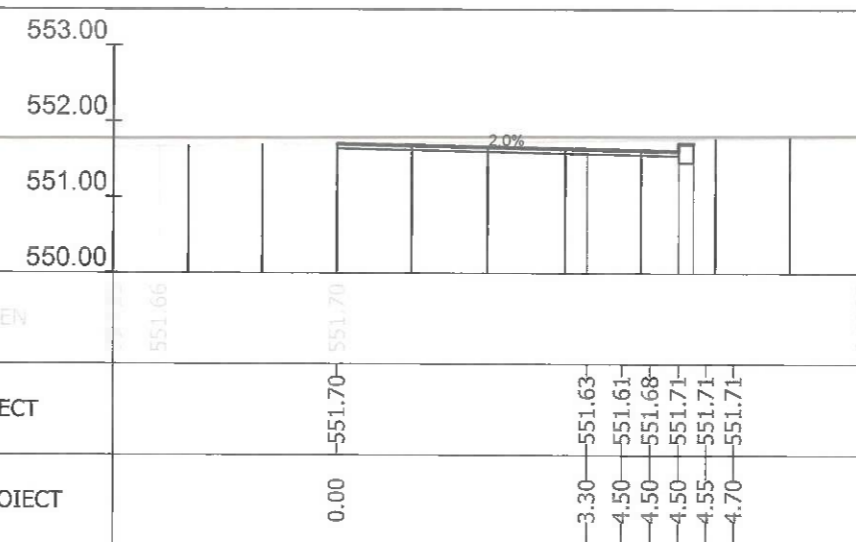
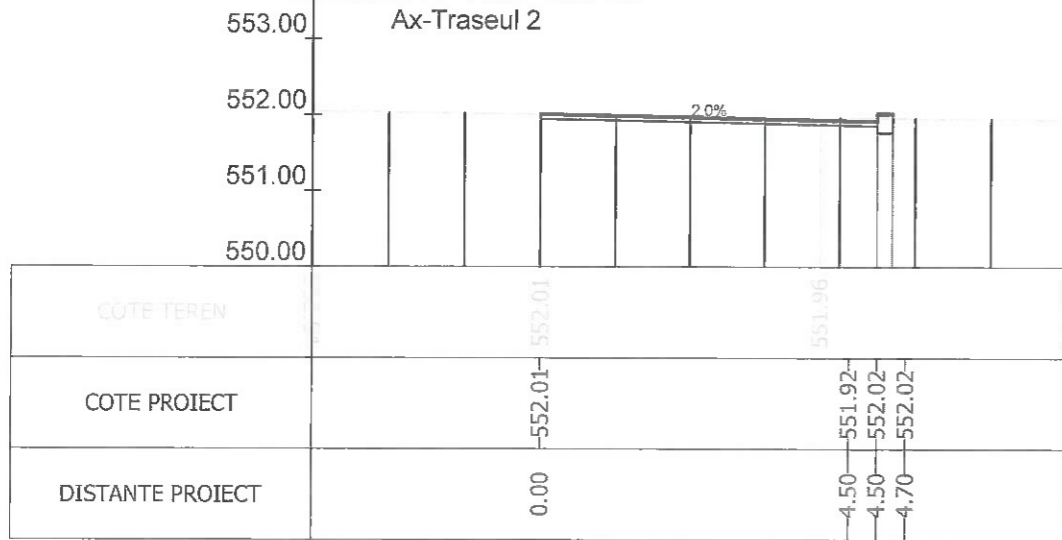

Sectiunea 43 - Km 0+675
Ax-Traseul 2

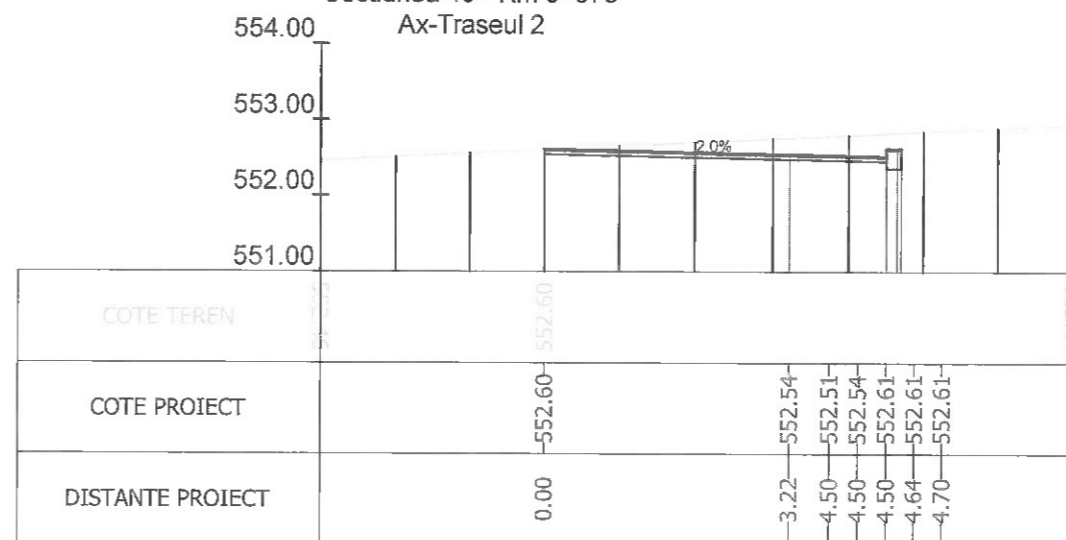

Sectiunea 44 - Km 0+700
Ax-Traseul 2

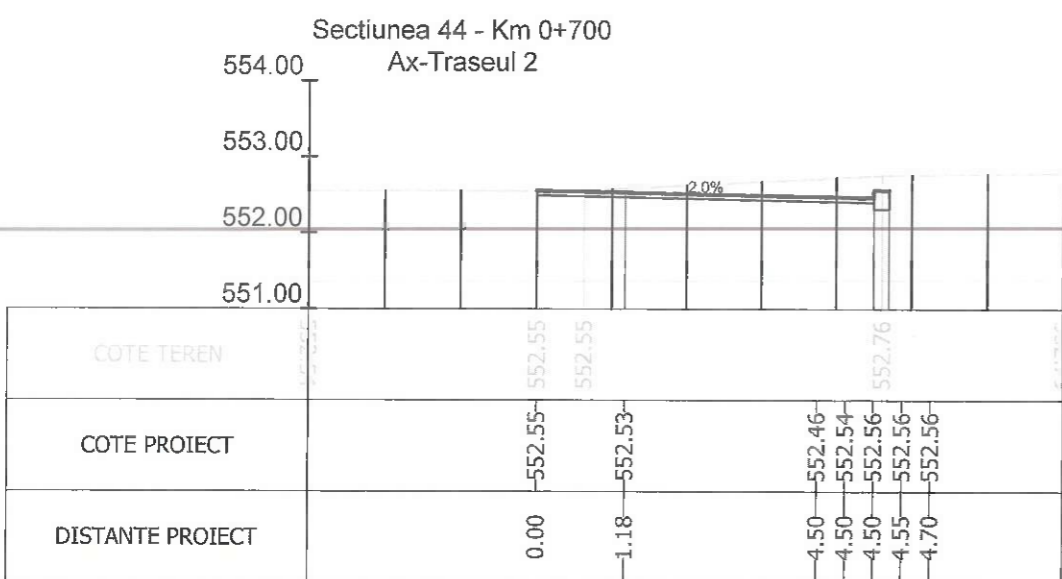

Sectiunea 45 - Km 0+725
Ax-Traseul 2

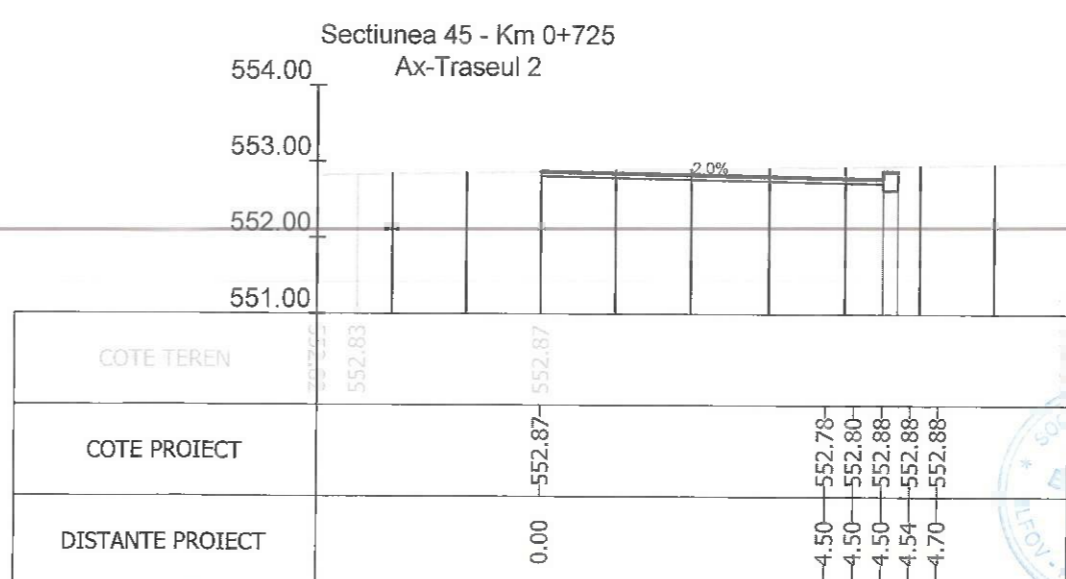

Sectiunea 46 - Km 0+750
Ax-Traseul 2



Index	A	Data	07/2023	Rev. 5
		Beneficiar: MUNICIPIUL BRASOV Bulevardul Eroilor 8, Brasov 500007		Nr. proiect 73 / 2020
Sef Proiect	Ing. A. Buta	Scara	1/100	Faza P.T.
Proiectat	Ing. A. Buta	Data	07/2023	Nr. plansa PT-68
Desenat	Ing. S. Patroi	Titlu plansa: PROFILE TRANSVERSALE CURENTE		
Verificat				

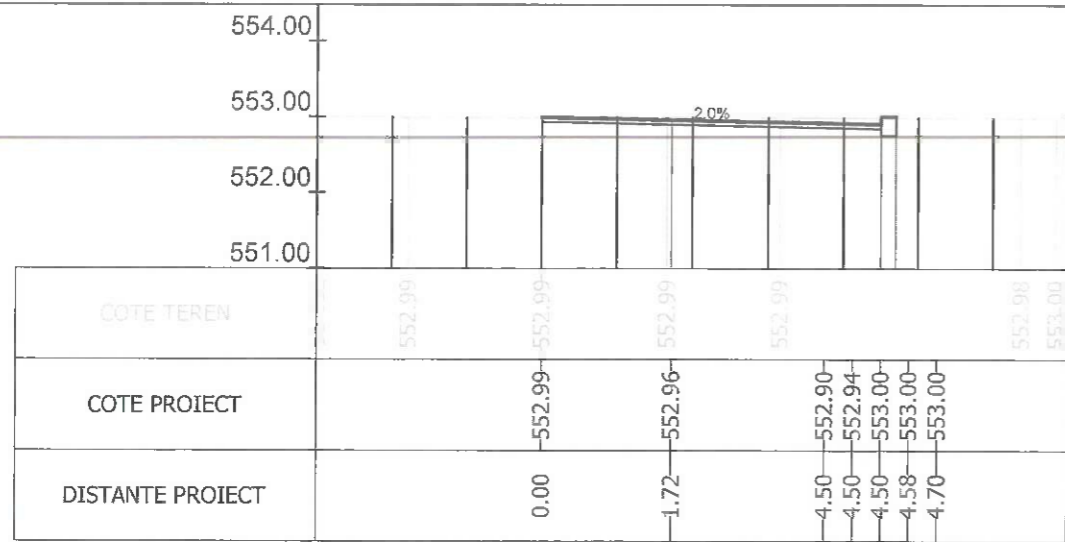

Sectiunea 48 - Km 0+775
Ax-Traseul 2

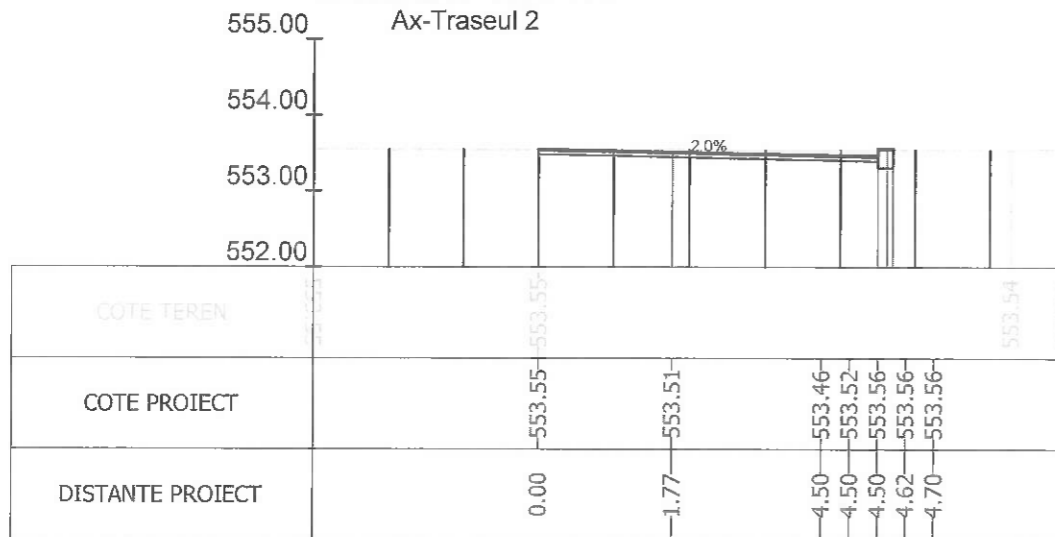

Sectiunea 50 - Km 0+825
Ax-Traseul 2

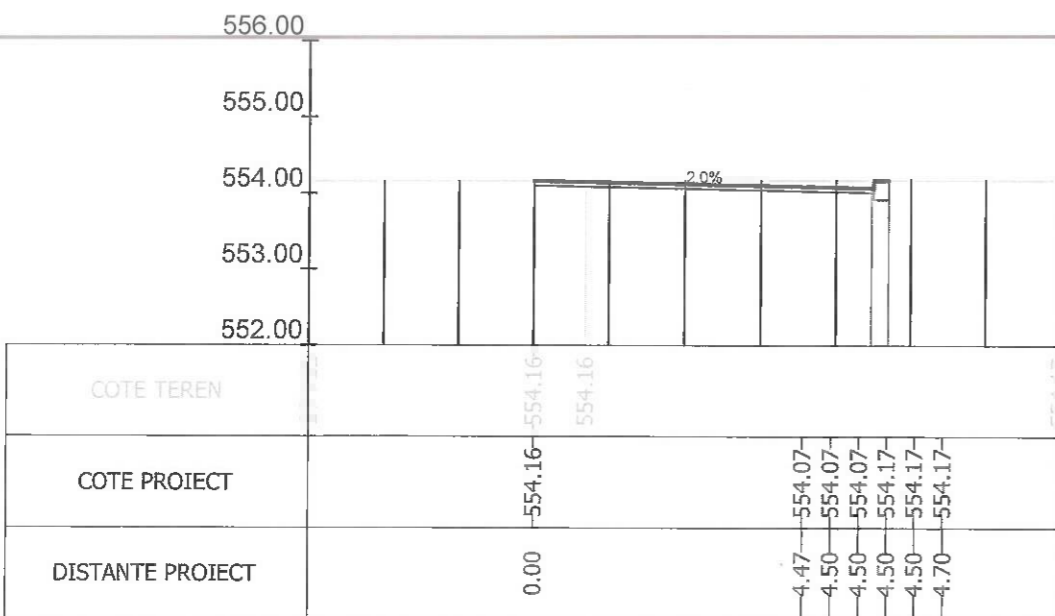

Sectiunea 52 - Km 0+875
Ax-Traseul 2

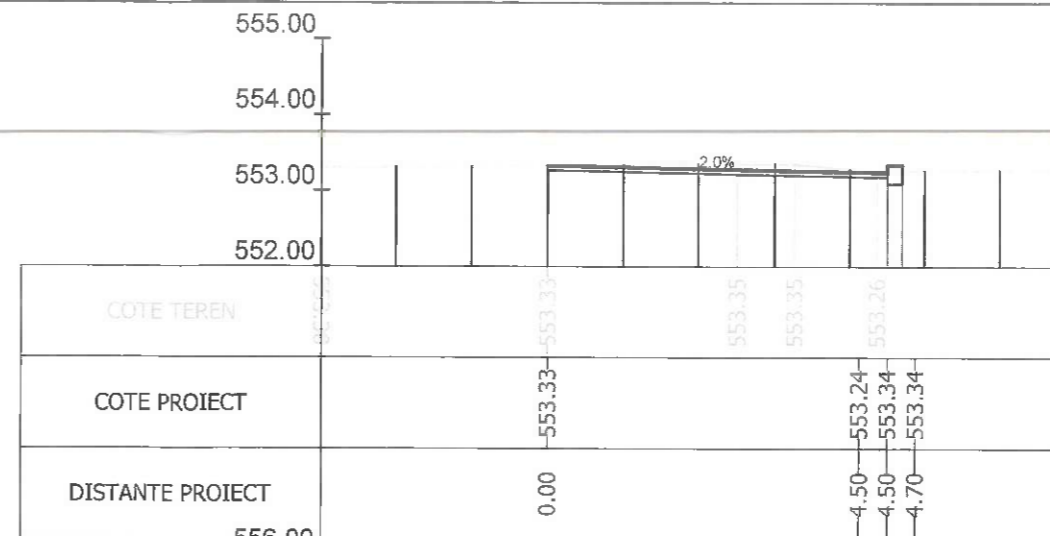

Sectiunea 49 - Km 0+800
Ax-Traseul 2

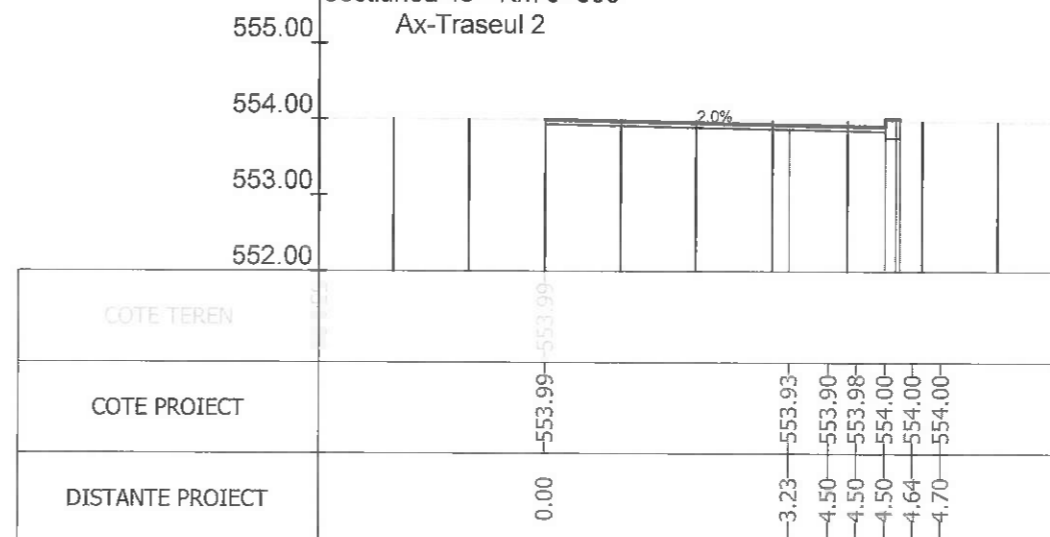

Sectiunea 51 - Km 0+850
Ax-Traseul 2

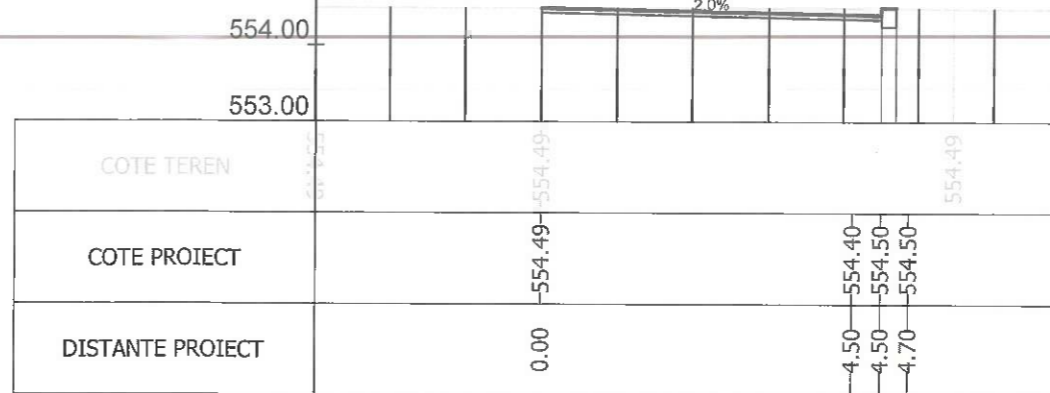

Sectiunea 53 - Km 0+900

index	Data Observații		Rev. 5
A			
			Beneficiar:
			MUNICIPIUL BRASOV Bulevardul Eroilor 8, Brasov 500007
Sef Proiect: Ing. A. Buta Proiectat: Ing. A. Buta Desenat: Ing. S. Patroi Verificat:			Nr. proiect 73 / 2020
Scara 1/100 Data 07/2023			Faza P.T.
Titlu proiect: AMENAJARE BENZI DEDICATE TRANSPORTULUI PUBLIC IN MUNICIPIUL BRASOV SI TROTUARE ADIACENTE			Nr. planșa PT-69
Titlu planșa: PROFILE TRANSVERSALE CURENTE			



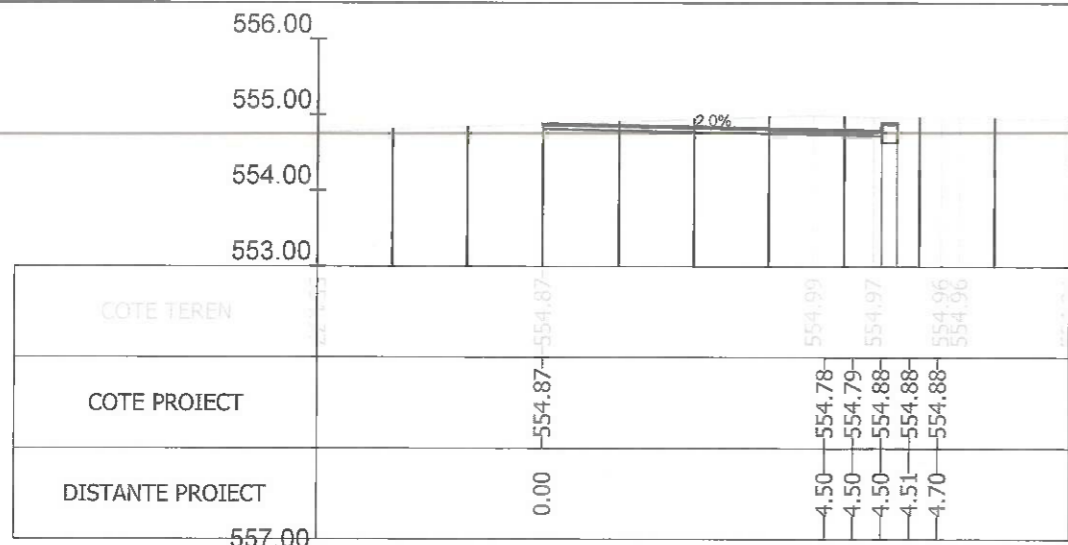

Sectiunea 54 - Km 0+921.617
Ax-Traseul 2

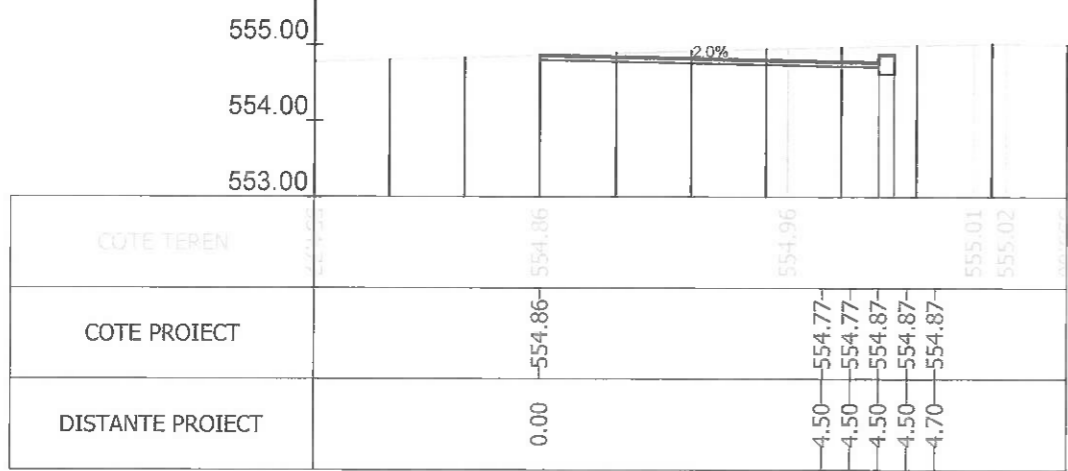

Sectiunea 56 - Km 0+925.617
Ax-Traseul 2

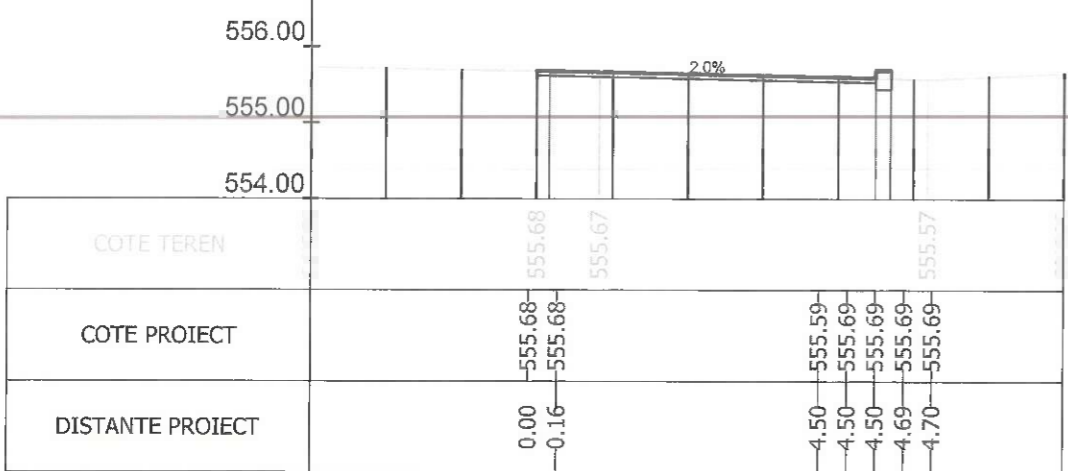

Sectiunea 58 - Km 0+975
Ax-Traseul 2

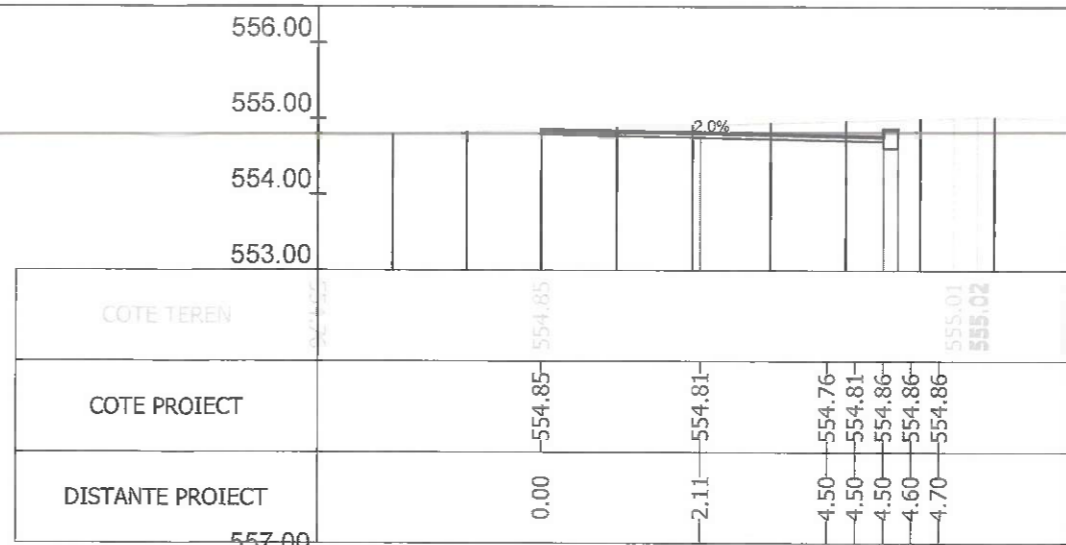

Sectiunea 55 - Km 0+925
Ax-Traseul 2

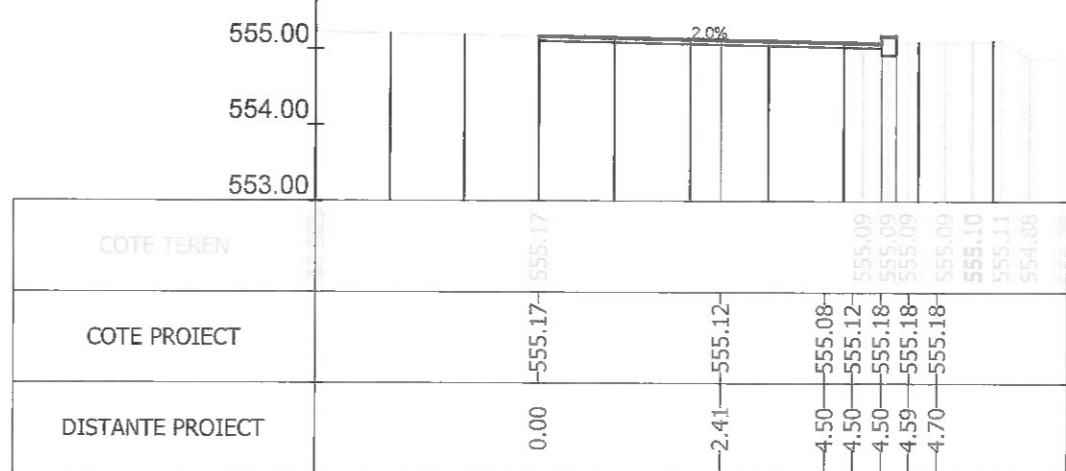

Sectiunea 57 - Km 0+950
Ax-Traseul 2

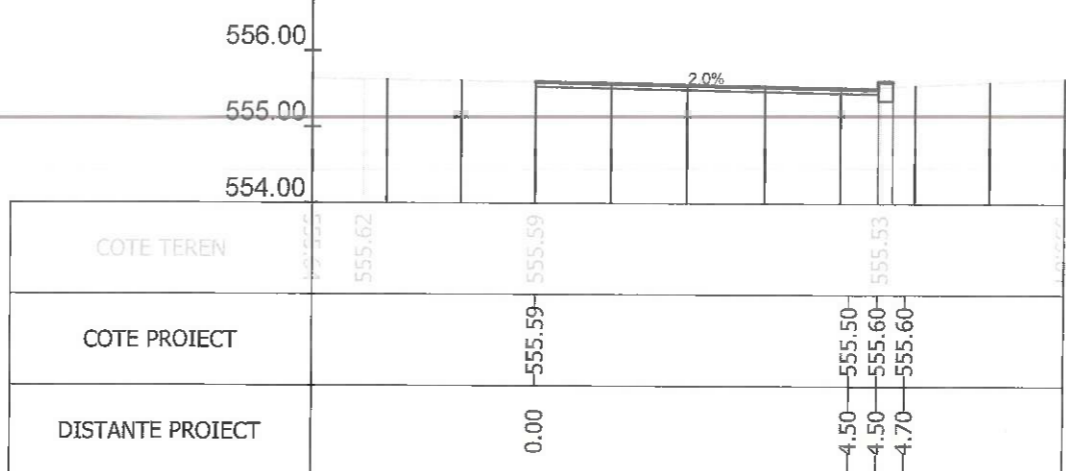

Sectiunea 59 - Km 0+981.838
Ax-Traseul 2



Index	A		Rev. 5
			Beneficiar:
Sef Proiect: Ing. A. Buta Proiectat: Ing. A. Buta Desenat: Ing. S. Patroi Verificat:			MUNICIPIUL BRASOV Bulevardul Eroilor 8, Brasov 500007
Scara: 1/100 Data: 07/2023			Nr. proiect: 73 / 2020 Faza: P.T. Nr. plansa: PT-70
Titlu proiect: AMENAJARE BENZI DEDICATE TRANSPORTULUI PUBLIC IN MUNICIPIUL BRASOV SI TROTUARE ADIACENTE Titlu plansa: PROFILE TRANSVERSALE CURENTE			

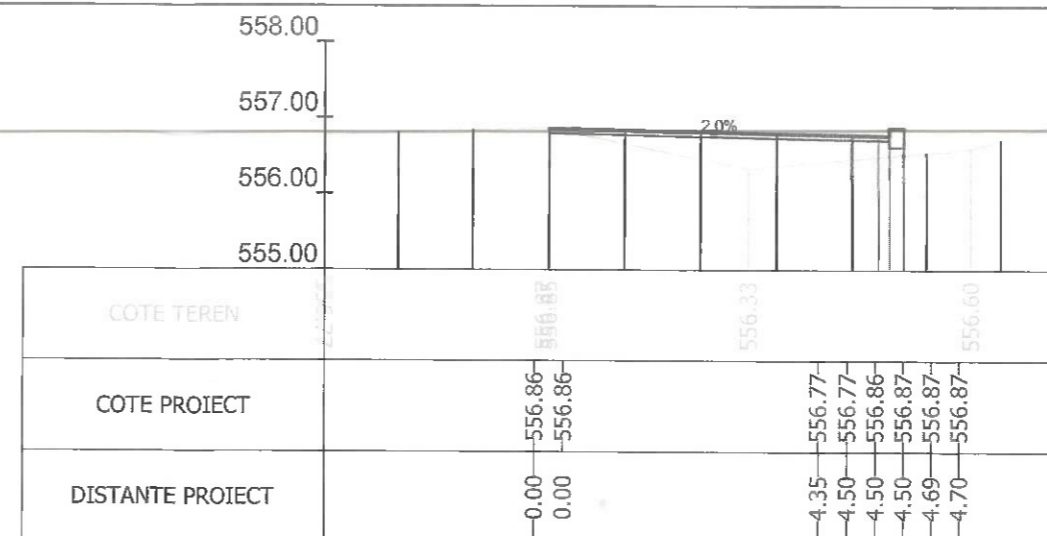
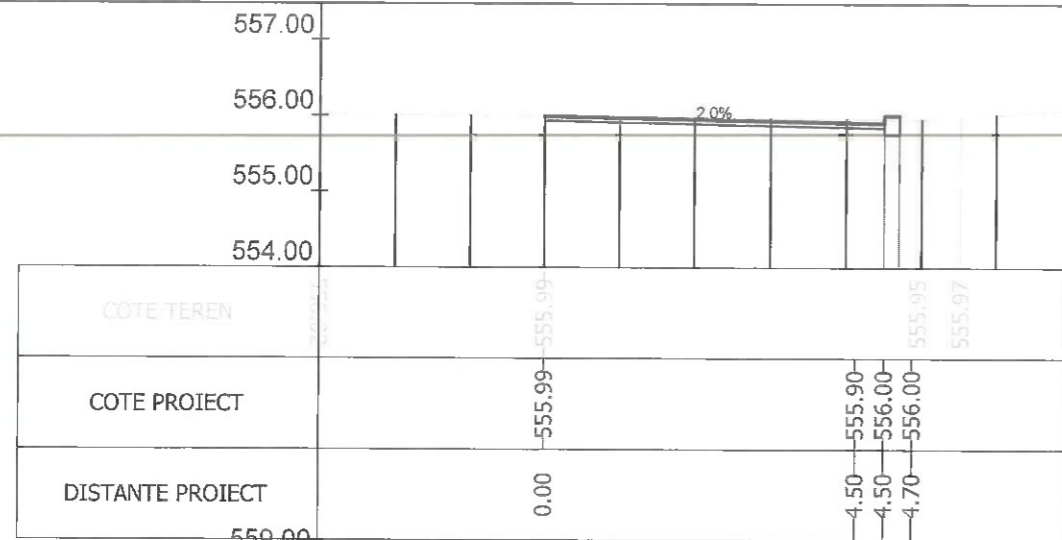

Sectiunea 60 - Km 1+000
Ax-Traseul 2

Sectiunea 61 - Km 1+025
Ax-Traseul 2

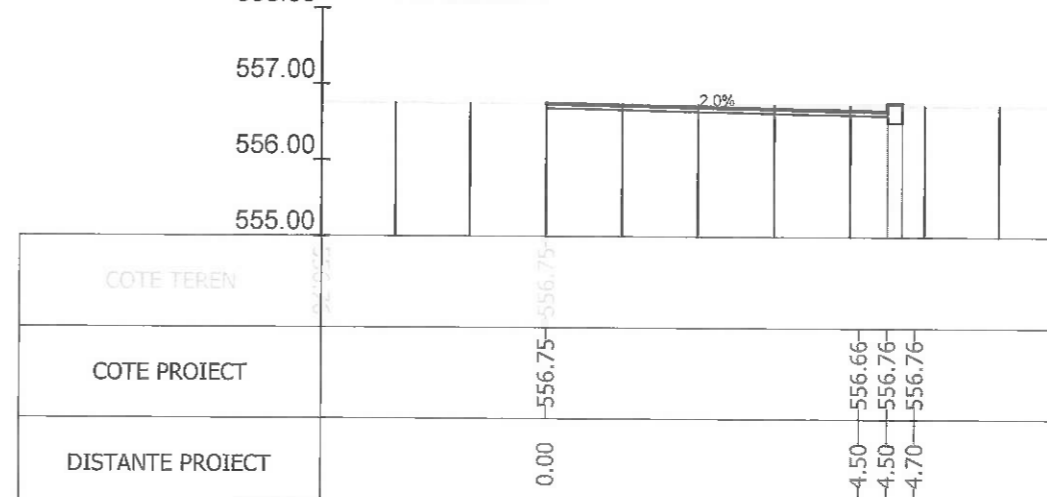
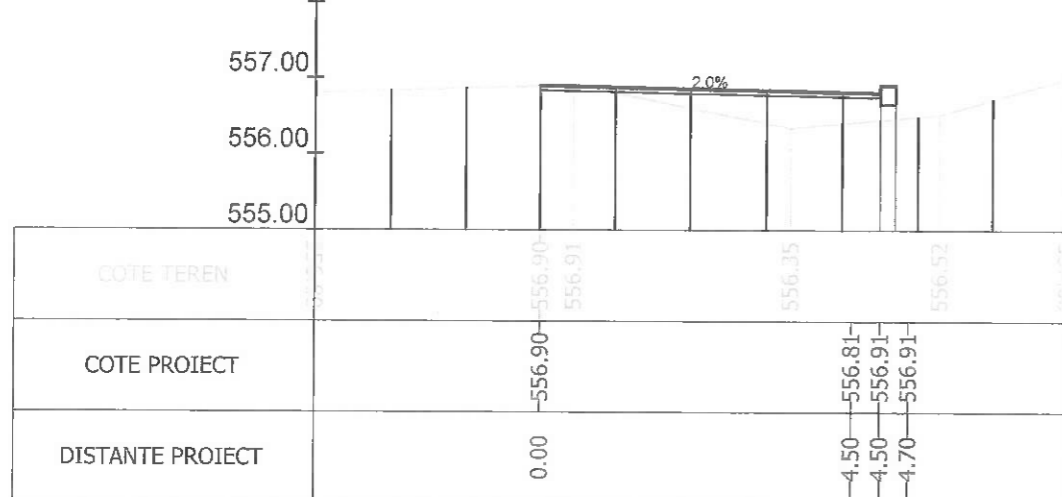

Sectiunea 62 - Km 1+025.474
Ax-Traseul 2

Sectiunea 63 - Km 1+050
Ax-Traseul 2

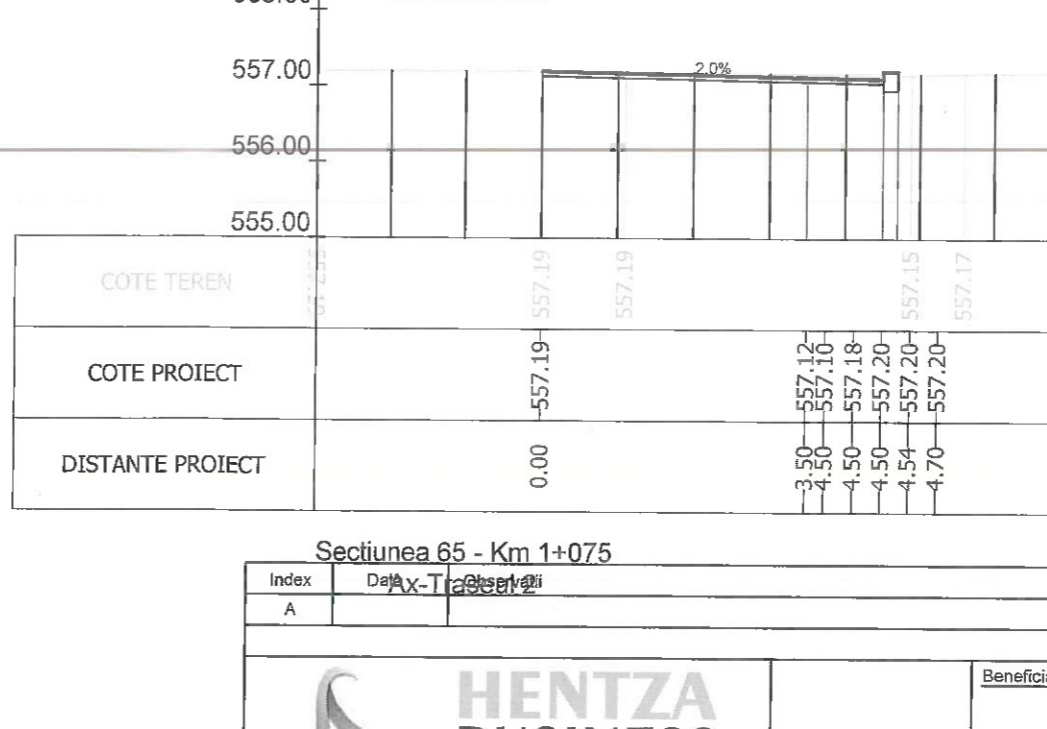
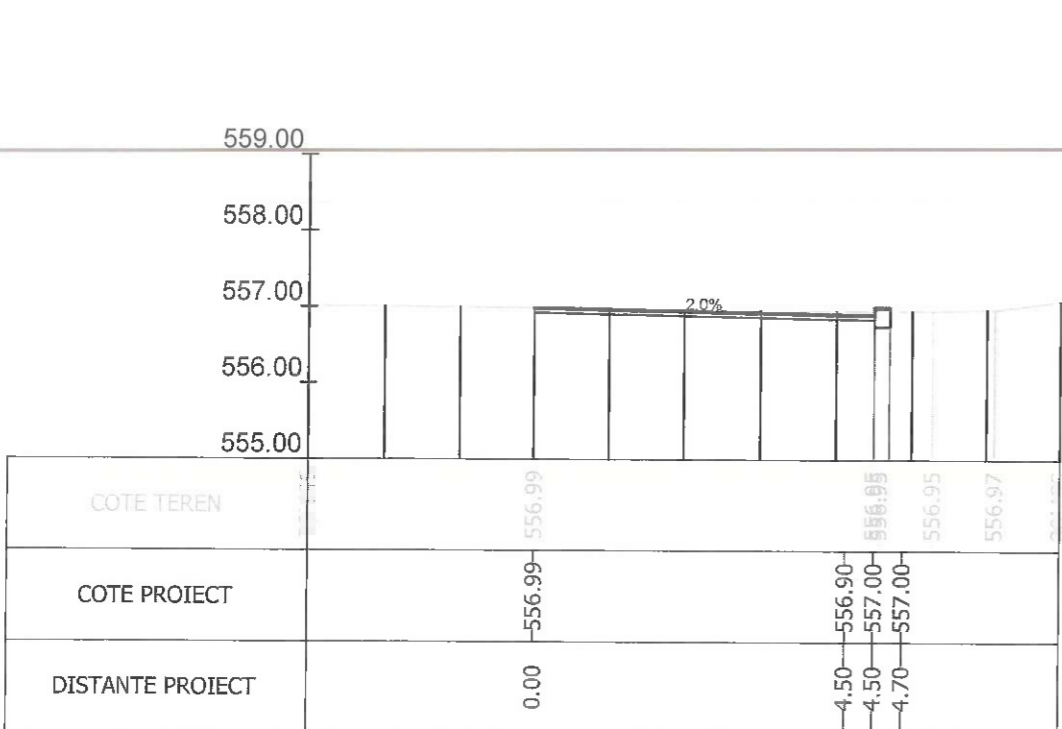

Sectiunea 64 - Km 1+069.109
Ax-Traseul 2

Sectiunea 65 - Km 1+075
Ax-Traseul 2



Index A	Data 07/2023	Observatii		Rev. 5
 www.hentza.ro SIELE, PORCATA TURANII NR. 17 (BIERI) NR. 2 BTAJ 4, MOLITANII BUCUR, TEL: +40 371 621944, EMAIL: OFFICE@HENTZA.RO		Beneficiar: MUNICIPIUL BRASOV Bulevardul Eroilor 8, Brasov 500007		Nr. proiect 73 / 2020
Sef Proiect Inginer	Ing. A. Buta	Titlu proiect: AMENAJARE BENZI DEDICATE TRANSPORTULUI PUBLIC IN MUNICIPIUL BRASOV SI TROTUARE ADIACENTE		Faza P.T.
Proiectat	Ing. A. Buta	Titlu plansa: PROFILE TRANSVERSALE CURENTE		Nr. plansa PT-71
Desenat	Ing. S. Patroi	Scara 1/100	Data 07/2023	
Verificat				

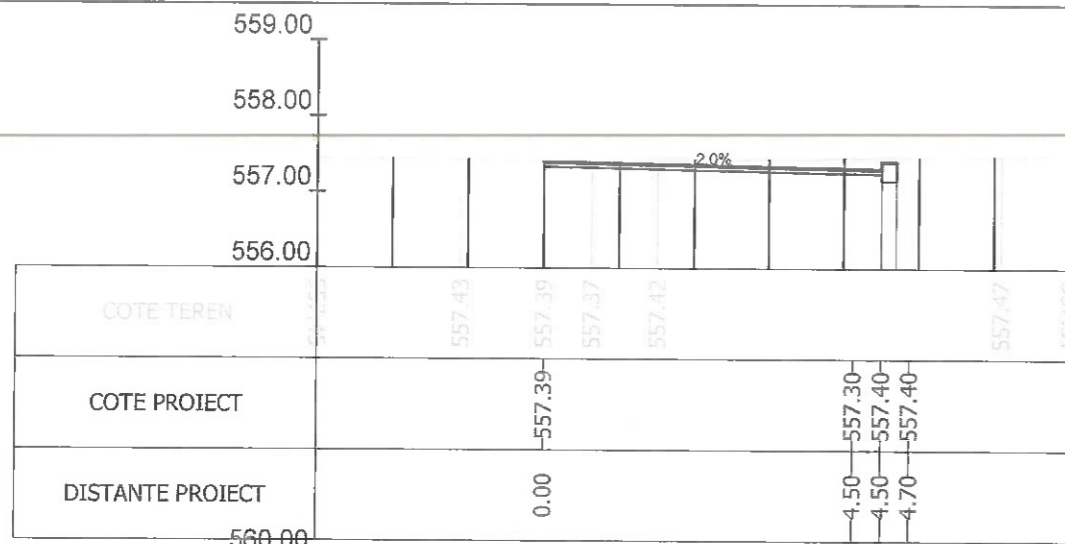

Sectiunea 66 - Km 1+093.154
Ax-Traseul 2

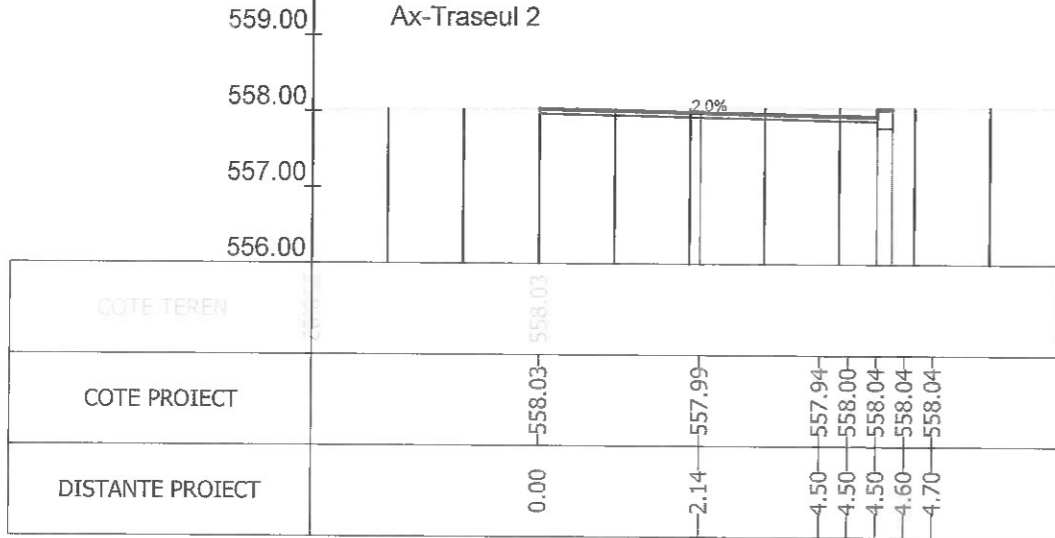

Sectiunea 68 - Km 1+125
Ax-Traseul 2

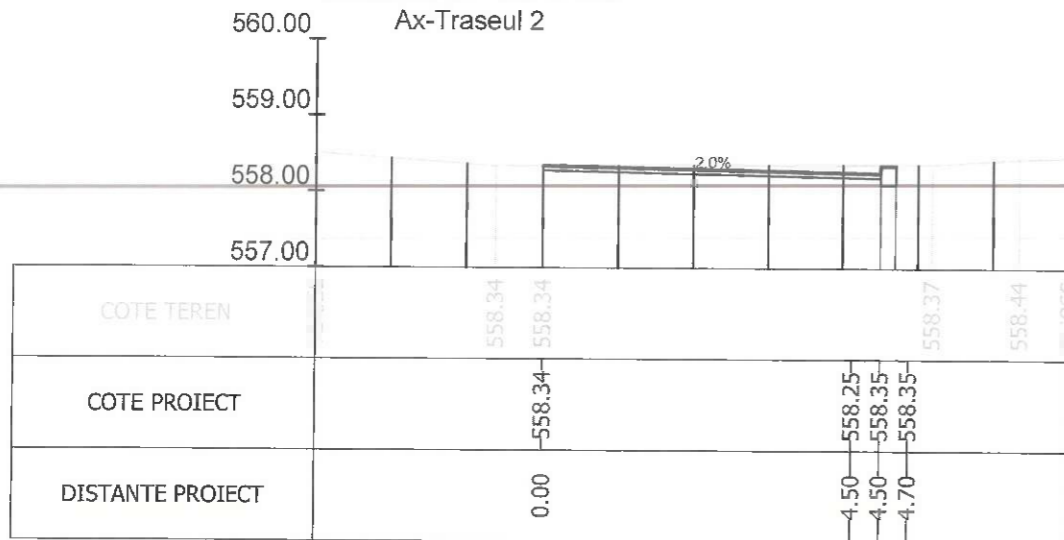

Sectiunea 70 - Km 1+150
Ax-Traseul 2

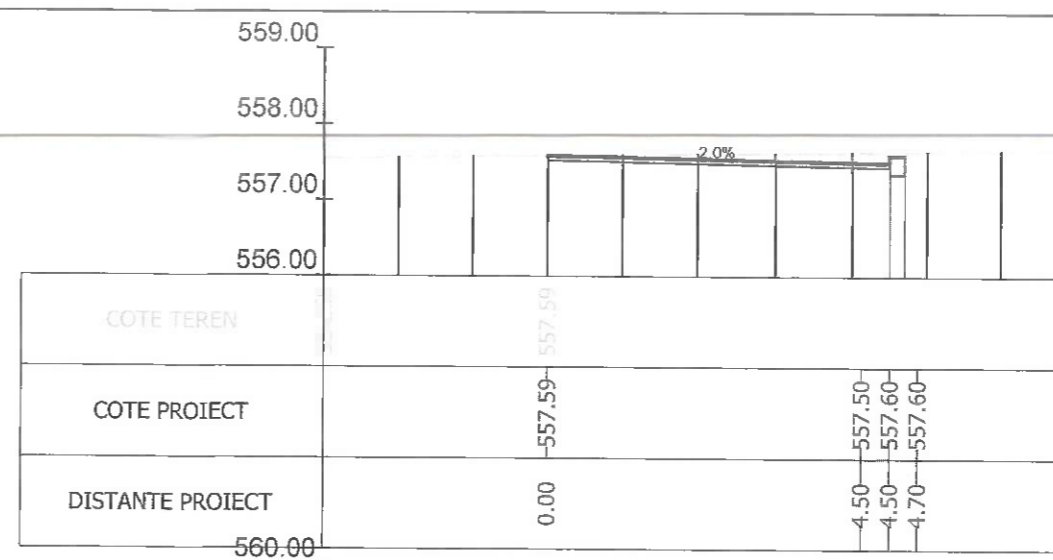

Sectiunea 67 - Km 1+100
Ax-Traseul 2

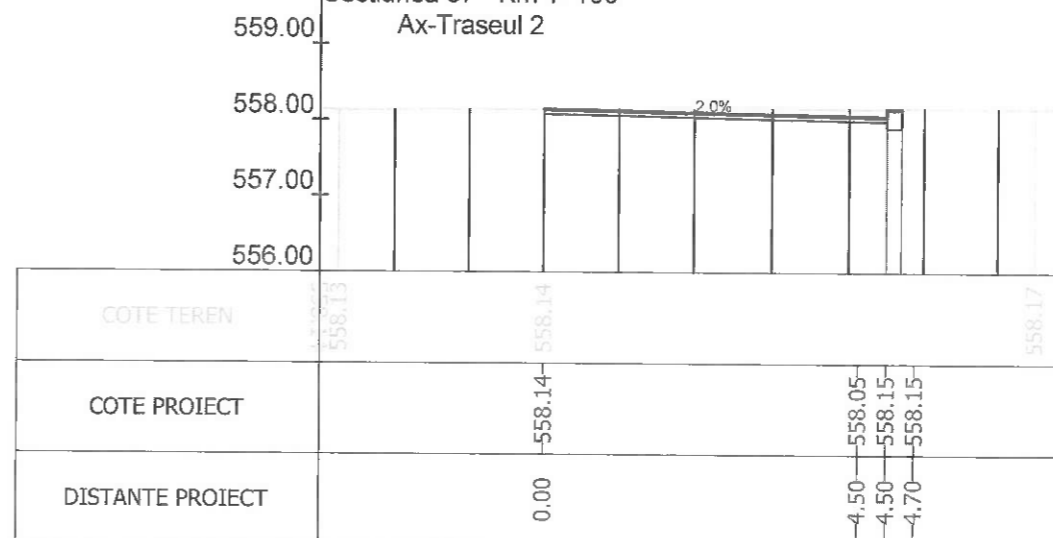

Sectiunea 69 - Km 1+130.560
Ax-Traseul 2

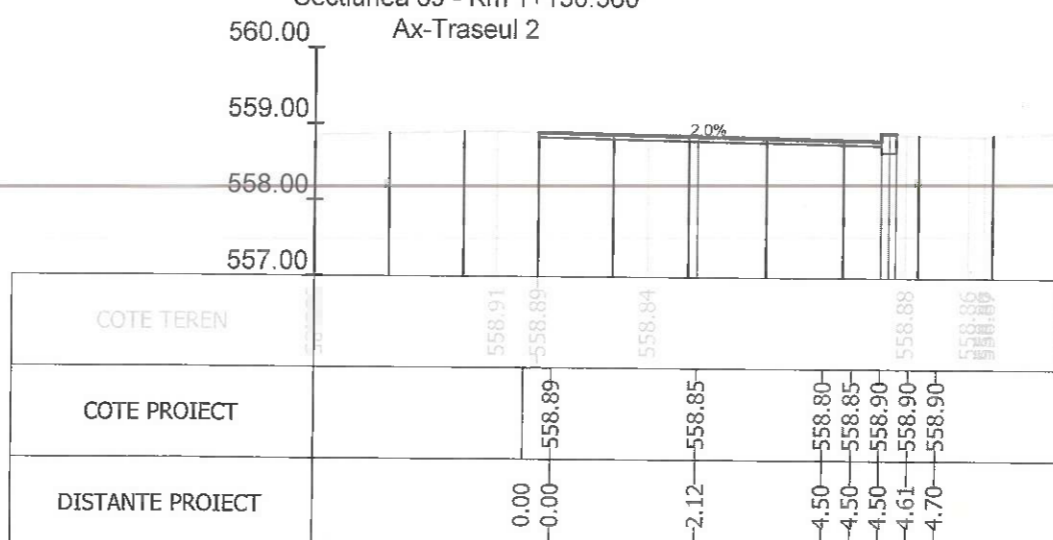

Sectiunea 71 - Km 1+175
Ax-Traseul 2



Index	A		Rev. 5
Beneficiar:		MUNICIPIUL BRASOV Bulevardul Eroilor 8, Brasov 500007	Nr. proiect 73 / 2020
Titlu proiect:		AMENAJARE BENZI DEDICATE TRANSPORTULUI PUBLIC IN MUNICIPIUL BRASOV SI TROTUARE ADIACENTE	Faza P.T.
Titlu plansa:		PROFILE TRANSVERSALE CURENTE	Nr. plansa PT-72
Sef Proiect	Ing. A. Buta	Scara	
Proiectat	Ing. A. Buta	1/100	
Desenat	Ing. S. Patroi	Data	
Verificat		07/2023	

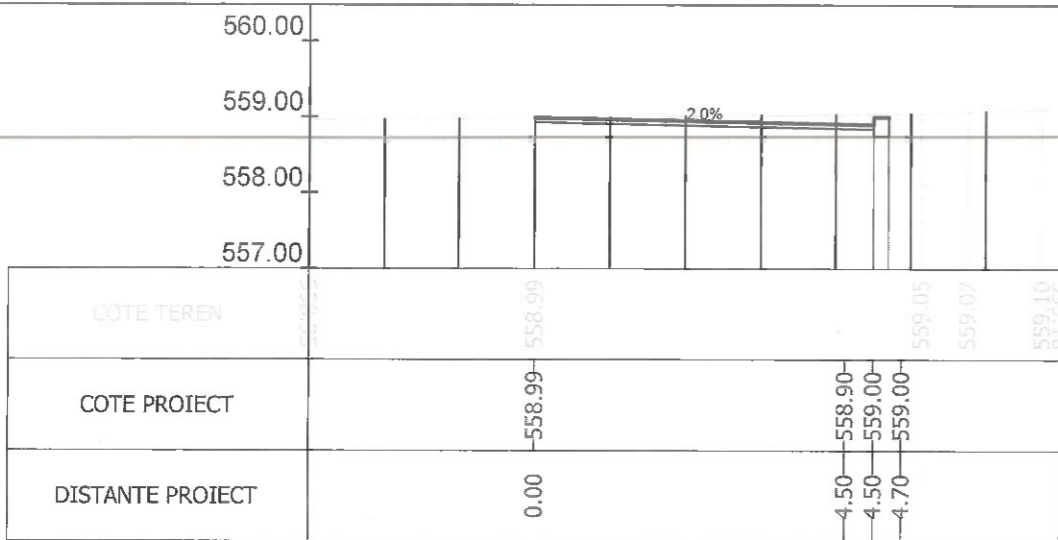

Sectiunea 72 - Km 1+187.376
Ax-Traseul 2

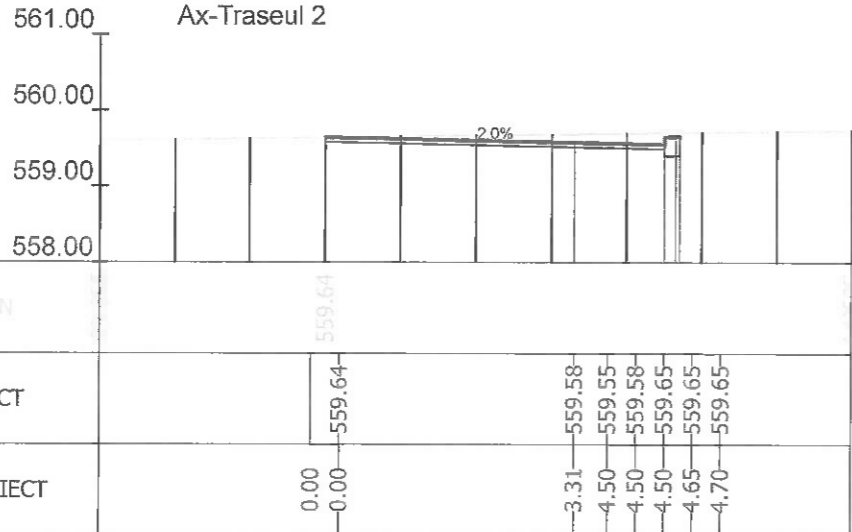

Sectiunea 74 - Km 1+225
Ax-Traseul 2

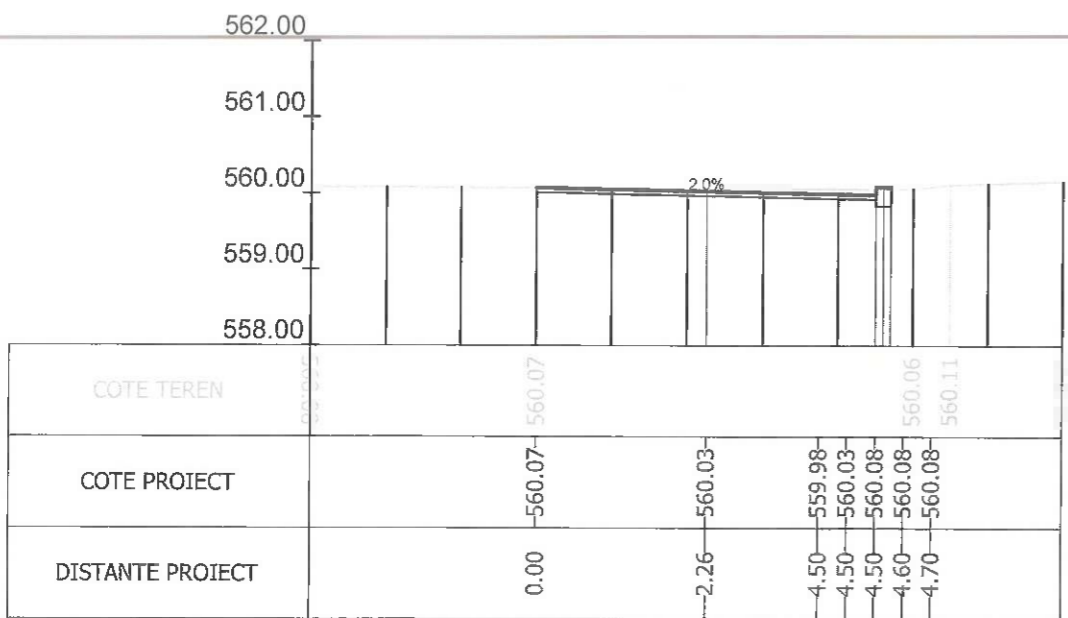

Sectiunea 76 - Km 1+250
Ax-Traseul 2

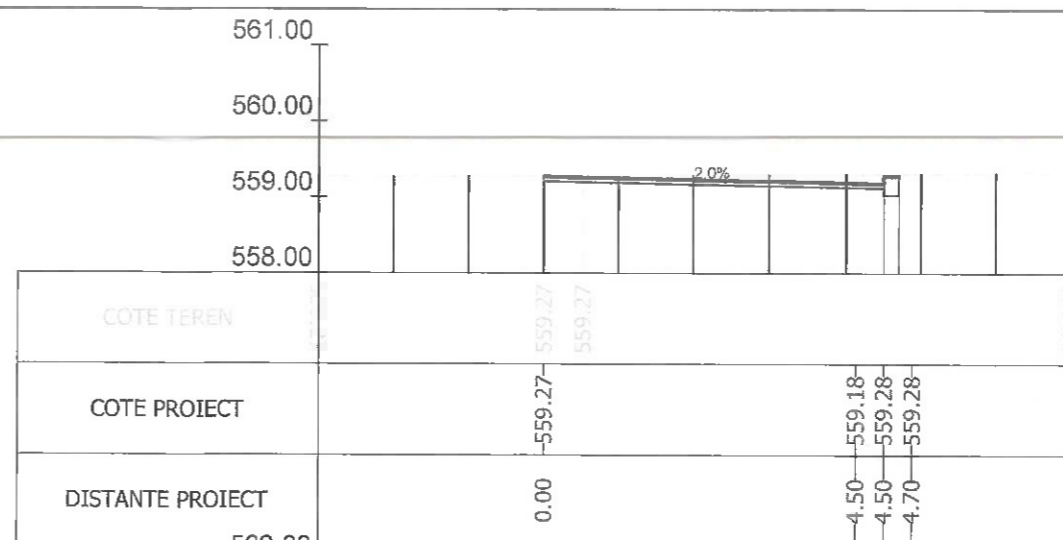

Sectiunea 73 - Km 1+200
Ax-Traseul 2

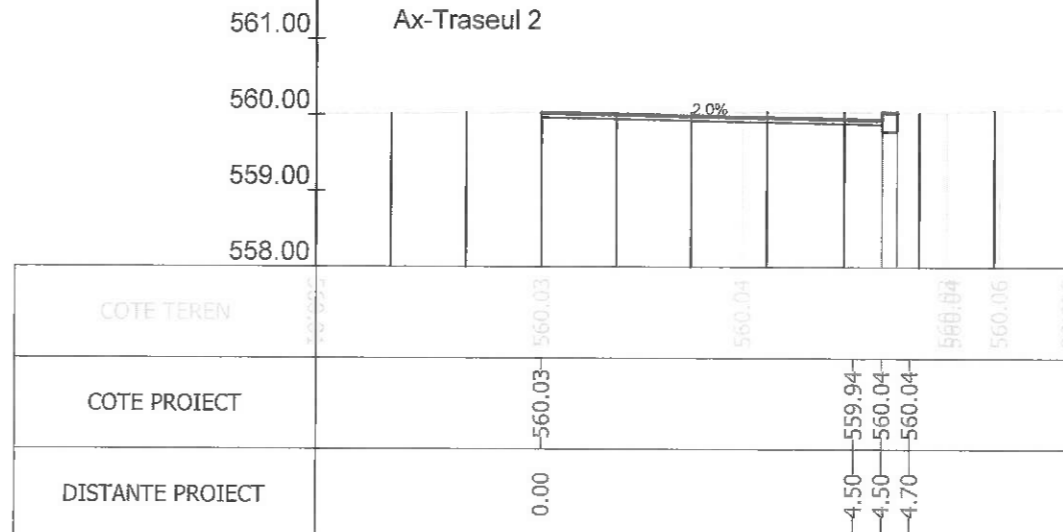

Sectiunea 75 - Km 1+244.192
Ax-Traseul 2

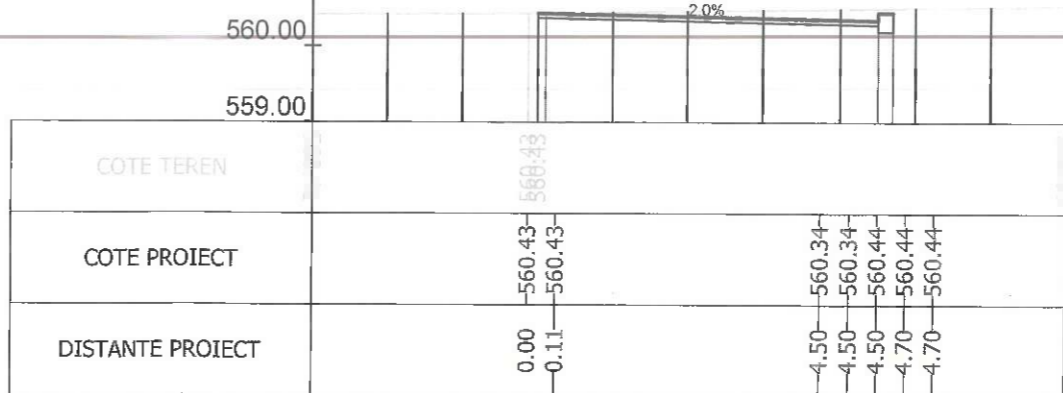

Sectiunea 77 - Km 1+275

Index	Data	Observatii	Rev. 5
A			
		Beneficiar:	MUNICIPIUL BRASOV Bulevardul Eroilor 8, Brasov 500007
Sef Proiect: Ing. A. Buta Proiectat: Ing. A. Buta Desenat: Ing. S. Patroi Verificat:		Titlu proiect:	AMENAJARE BENZI DEDICATE TRANSPORTULUI PUBLIC IN MUNICIPIUL BRASOV SI TROTUARE ADIACENTE
Scara: 1/100 Data: 07/2023		Titlu plansa:	PROFILE TRANSVERSALE CURENTE
		Nr. proiect:	73 / 2020
		Faza P.T.:	
		Nr. plansa:	PT-73

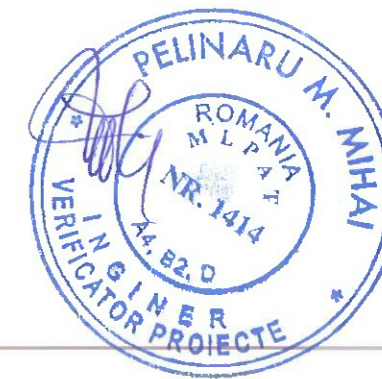

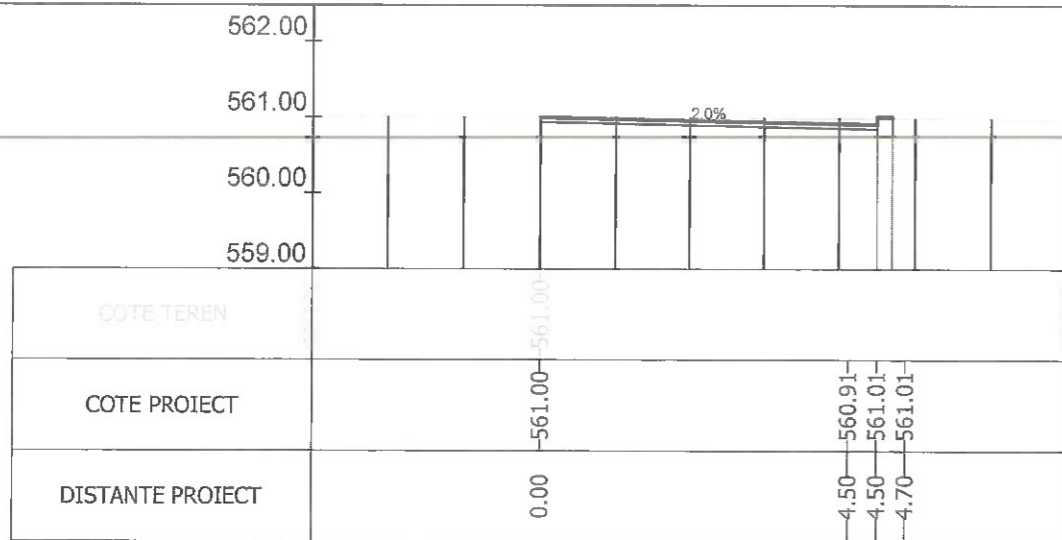

Sectiunea 79 - Km 1+300
Ax-Traseul 2

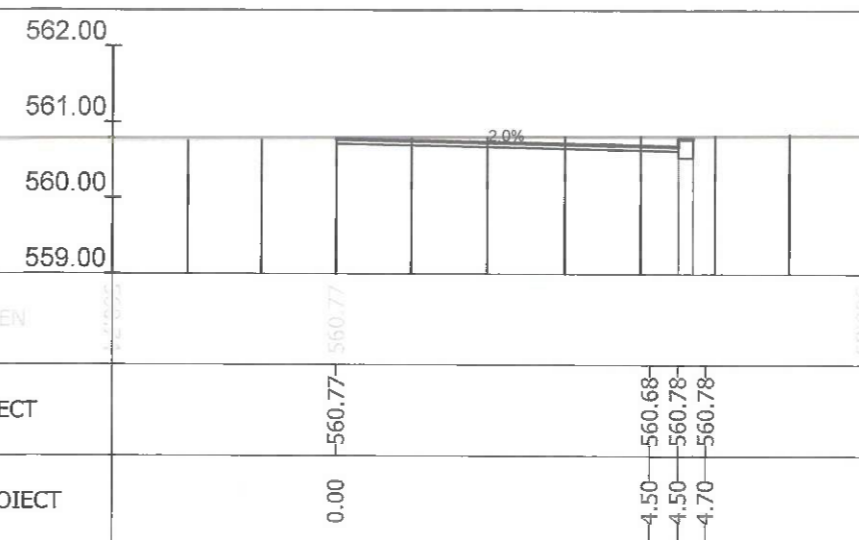
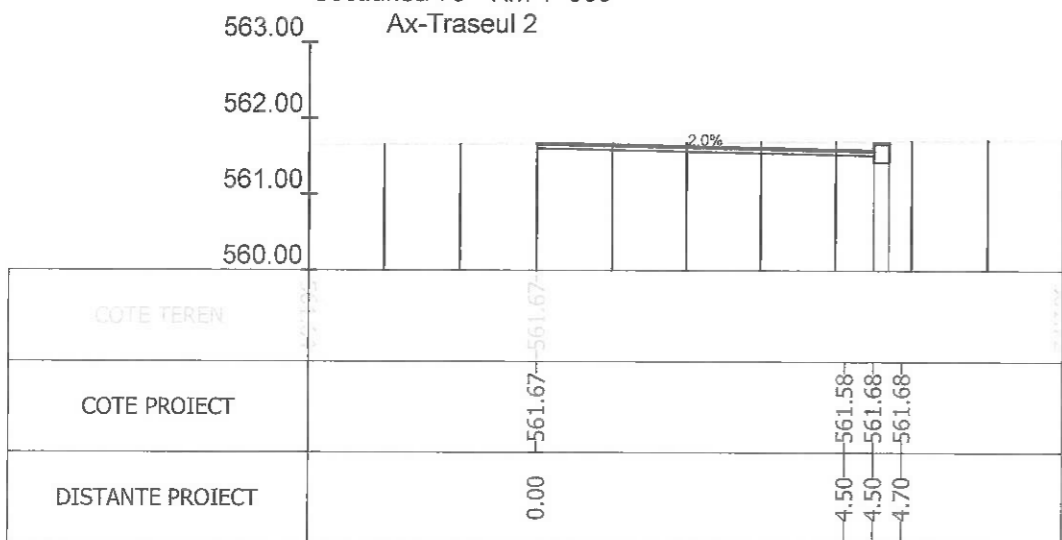

Sectiunea 78 - Km 1+286.630
Ax-Traseul 2

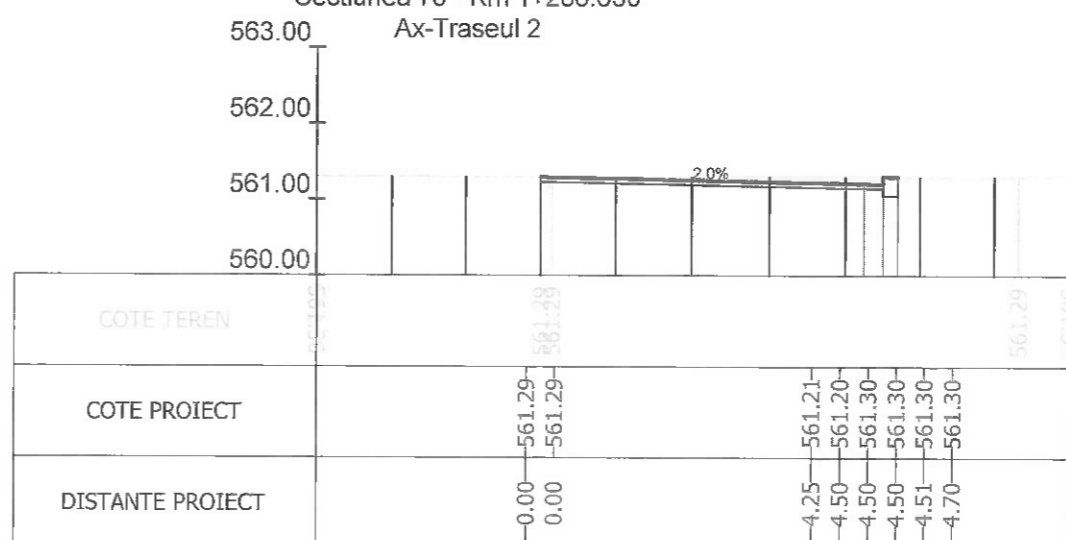

Sectiunea 80 - Km 1+325
Ax-Traseul 2

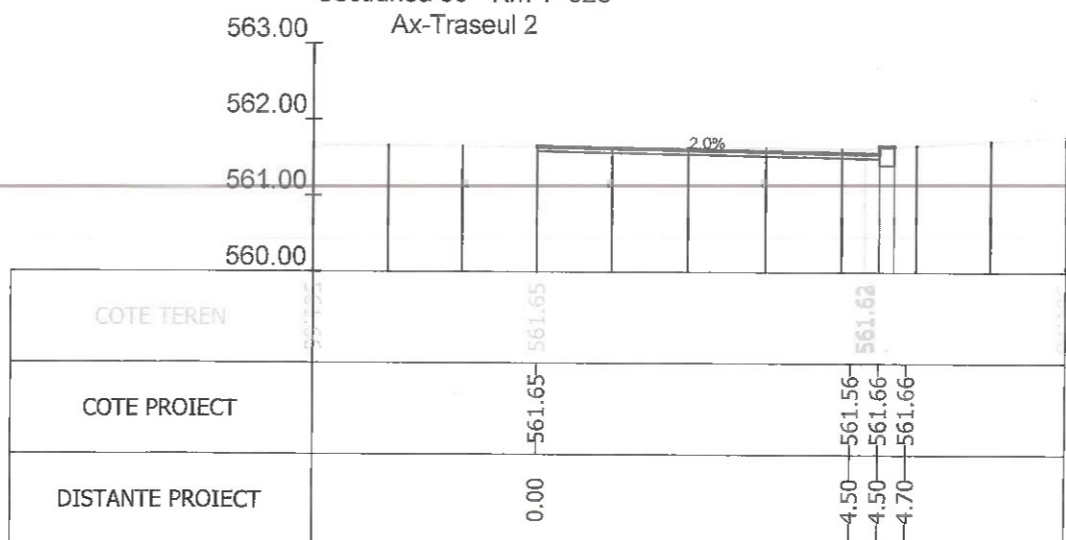

Sectiunea 82 - Km 1+350
Ax-Traseul 2

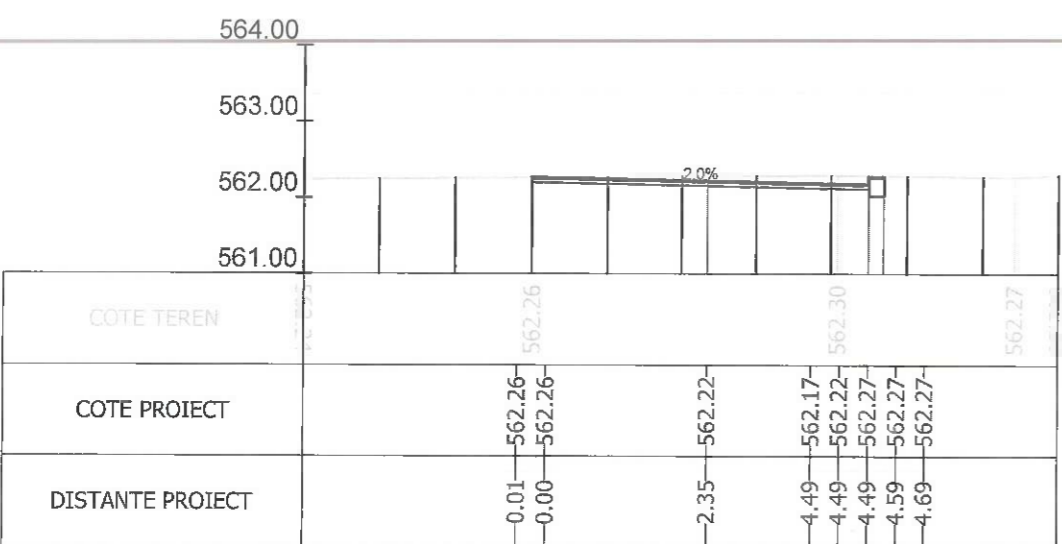

Sectiunea 83 - Km 1+375
Ax-Traseul 2

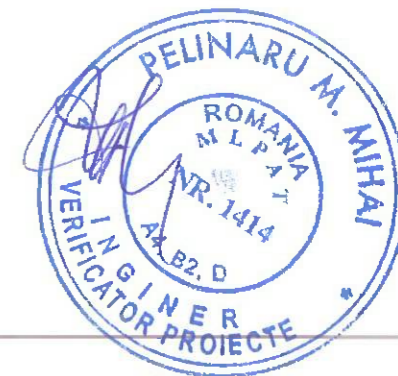

Index	Data	Rev. 5
A		
		Beneficiar:
Sef Proiect Ing. A. Buta Proiectat Ing. A. Buta Desenat Ing. S. Patroi Verificat		MUNICIPIUL BRASOV Bulevardul Eroilor 8, Brasov 500007
Scara 1/100 Data 07/2023		Nr. proiect 73 / 2020 Faza P.T. Nr. plansa PT-74
		Titlu proiect: AMENAJARE BENZI DEDICATE TRANSPORTULUI PUBLIC IN MUNICIPIUL BRASOV SI TROTUARE ADIACENTE Titlu plansa: PROFILE TRANSVERSALE CURENTE

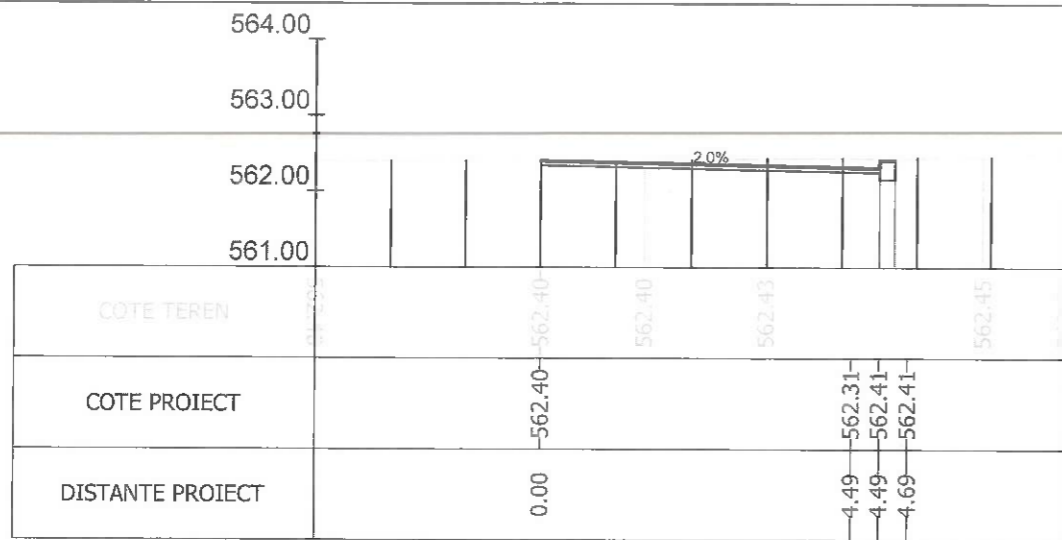

Sectiunea 84 - Km 1+391.567
Ax-Traseul 2

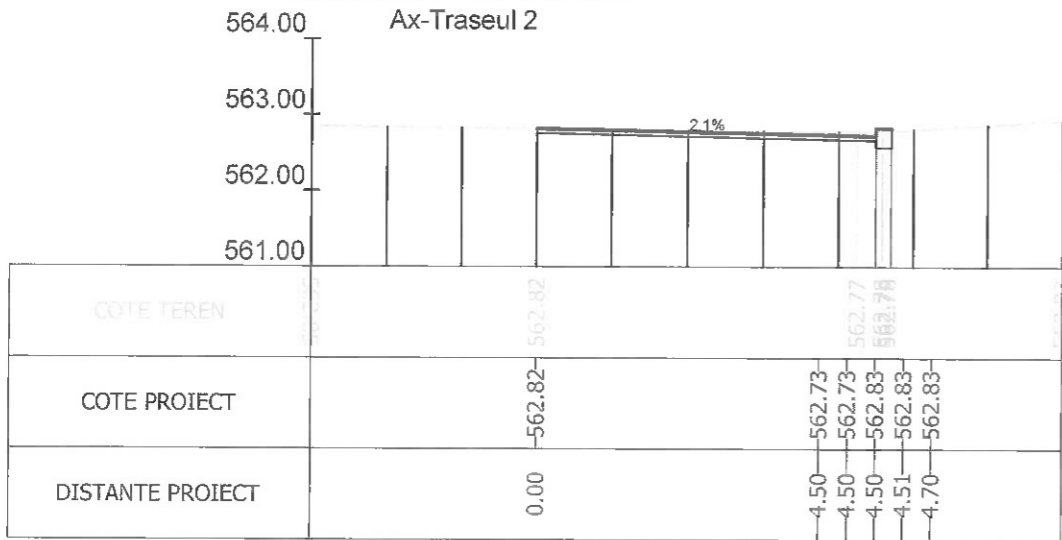

Sectiunea 86 - Km 1+414.592
Ax-Traseul 2

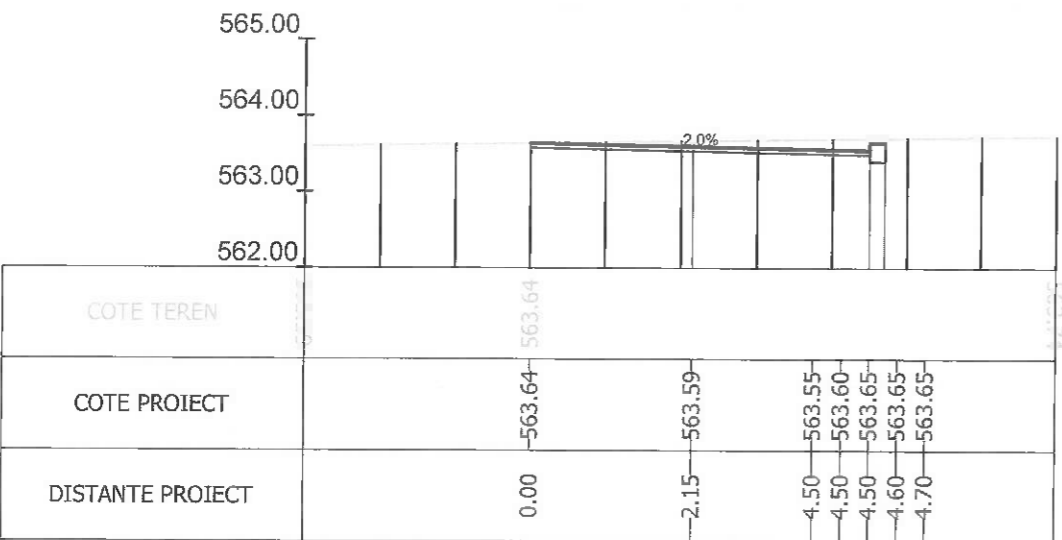

Sectiunea 88 - Km 1+450
Ax-Traseul 2

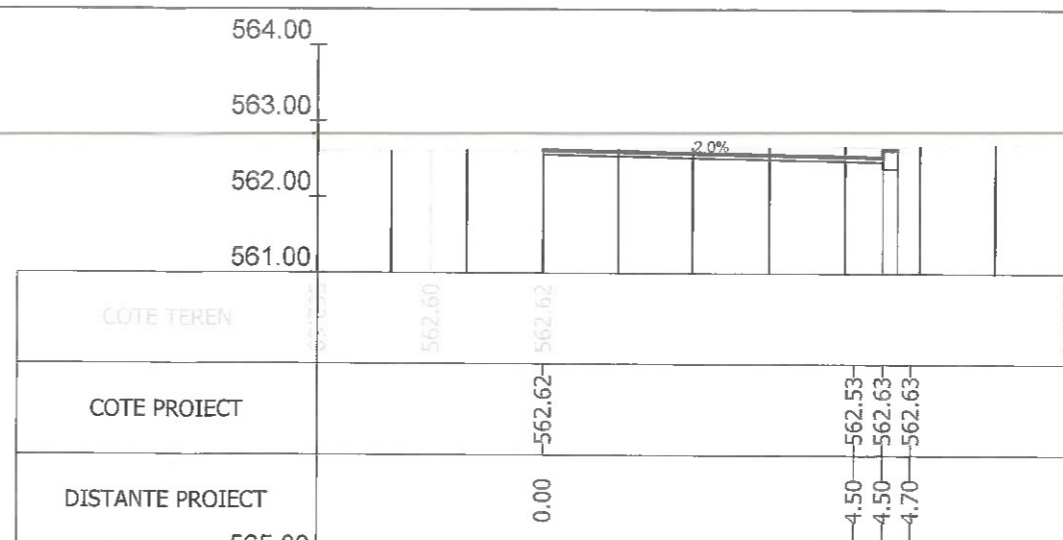

Sectiunea 85 - Km 1+400
Ax-Traseul 2

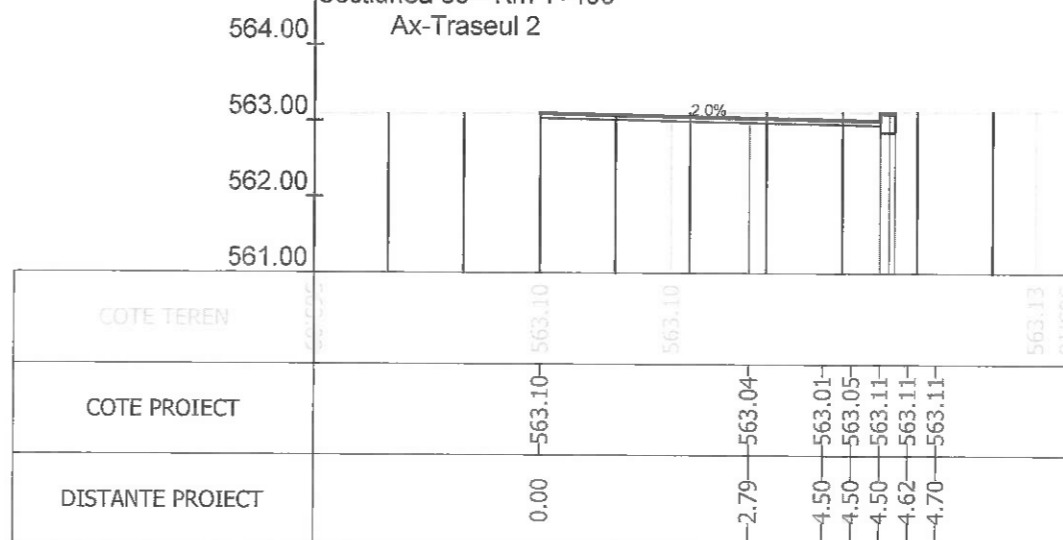

Sectiunea 87 - Km 1+425
Ax-Traseul 2

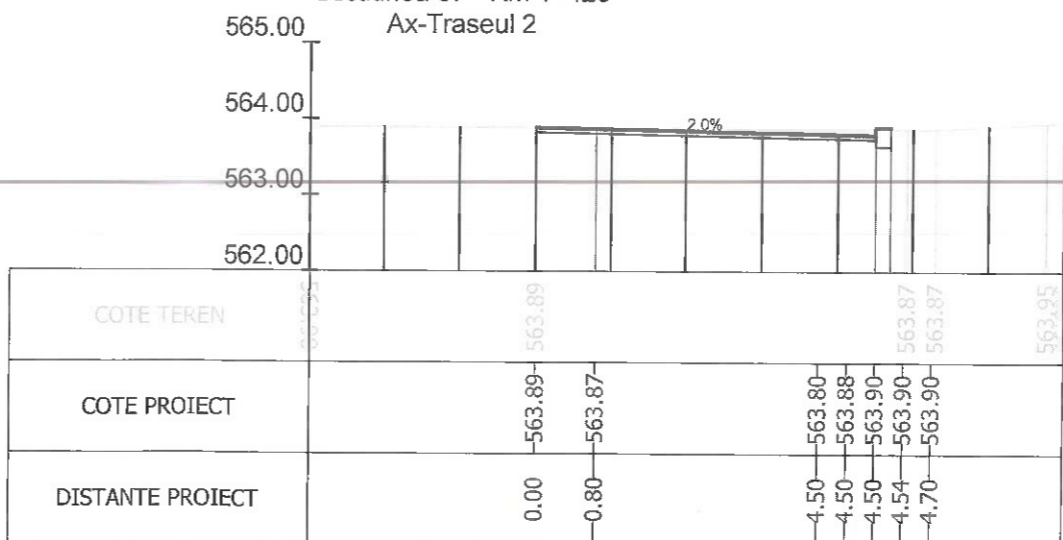

Sectiunea 89 - Km 1+475
Ax-Traseul 2

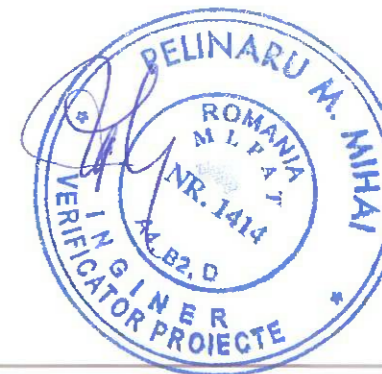

Index	Data	Rev. 5
A		
		Beneficiar: MUNICIPIUL BRASOV Bulevardul Eroilor 8, Brasov 500007
Sef Proiect	Ing. A. Buta	Nr. proiect: 73 / 2020
Proiectat	Ing. A. Buta	Titlu proiect: AMENAJARE BENZI DEDICATE TRANSPORTULUI PUBLIC IN MUNICIPIUL BRASOV SI TROTUARE ADIACENTE
Desenat	Ing. S. Patroi	Faza P.T.
Verificat		Titlu plansa: PROFILE TRANSVERSALE CURENTE
	Scara 1/100	Nr. plansa PT-75
	Data 07/2023	

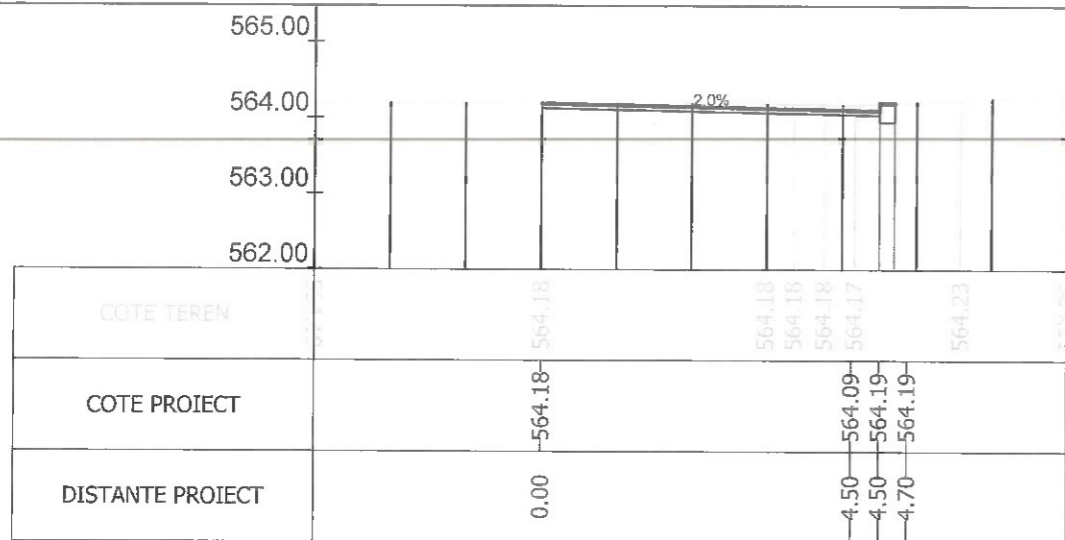

Sectiunea 90 - Km 1+491.116
Ax-Traceul 2

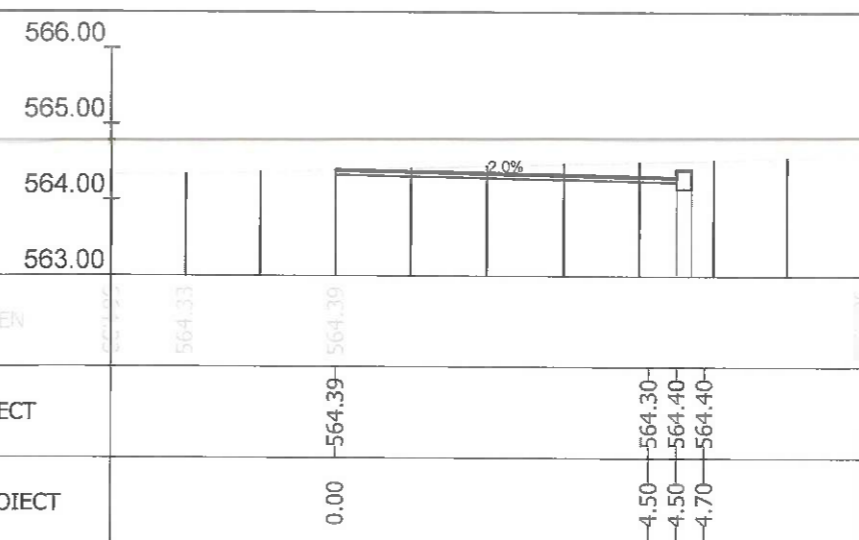
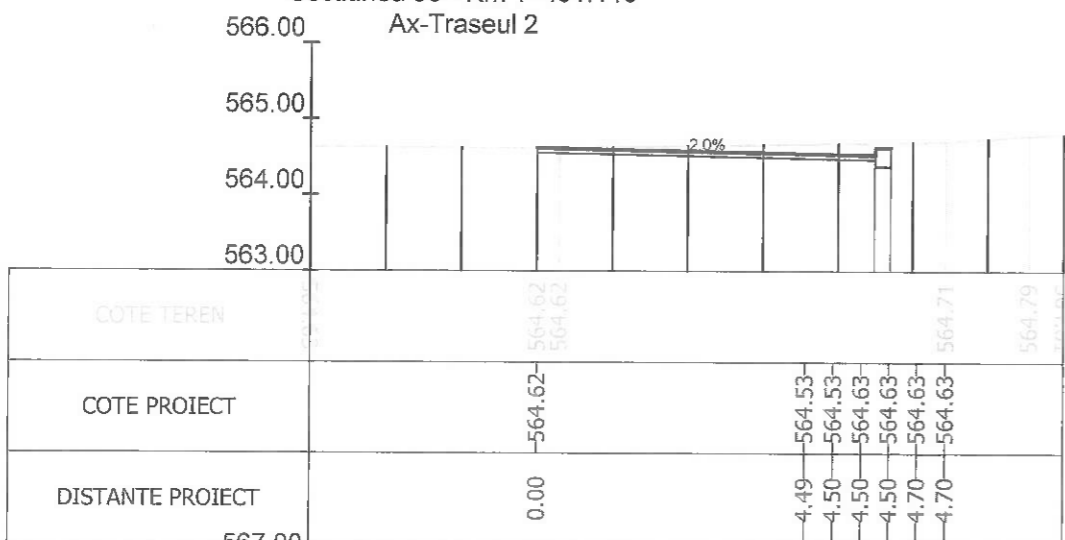

Sectiunea 91 - Km 1+500
Ax-Traceul 2

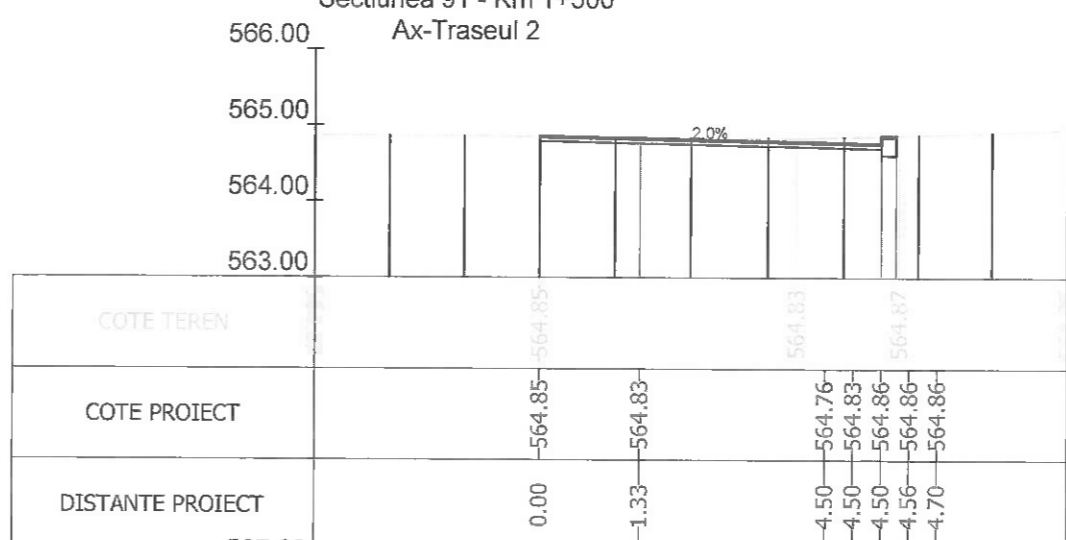

Sectiunea 92 - Km 1+514.743
Ax-Traceul 2

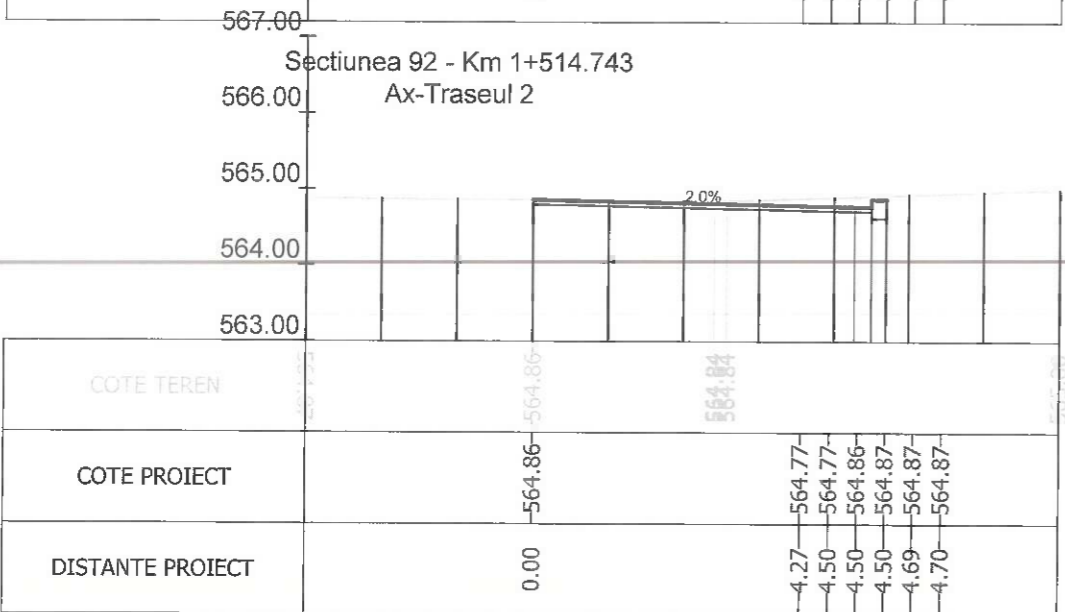

Sectiunea 93 - Km 1+525
Ax-Traceul 2

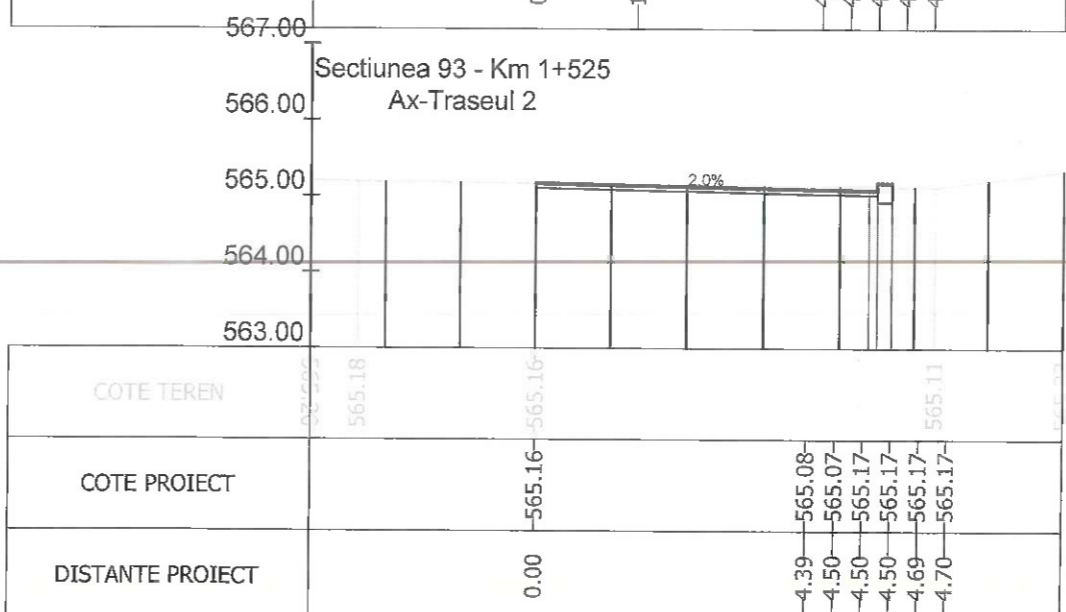

Sectiunea 94 - Km 1+527.499
Ax-Traceul 2

Index	Data	Observatii	Rev. 5
A			
		Beneficiar:	MUNICIPIUL BRASOV Bulevardul Eroilor 8, Brasov 500007
Sef Proiect	Ing. A. Buta	Titlu proiect:	AMENAJARE BENZI DEDICATE TRANSPORTULUI PUBLIC IN MUNICIPIUL BRASOV SI TROTUARE ADIACENTE
Proiectat	Ing. A. Buta	Titlu plansa:	PROFILE TRANSVERSALE CURENTE
Desenat	Ing. S. Patroi	Scara	1/100
Verificat		Data	07/2023
		Nr. proiect	73 / 2020
		Faza	P.T.
		Nr. plansa	PT-76



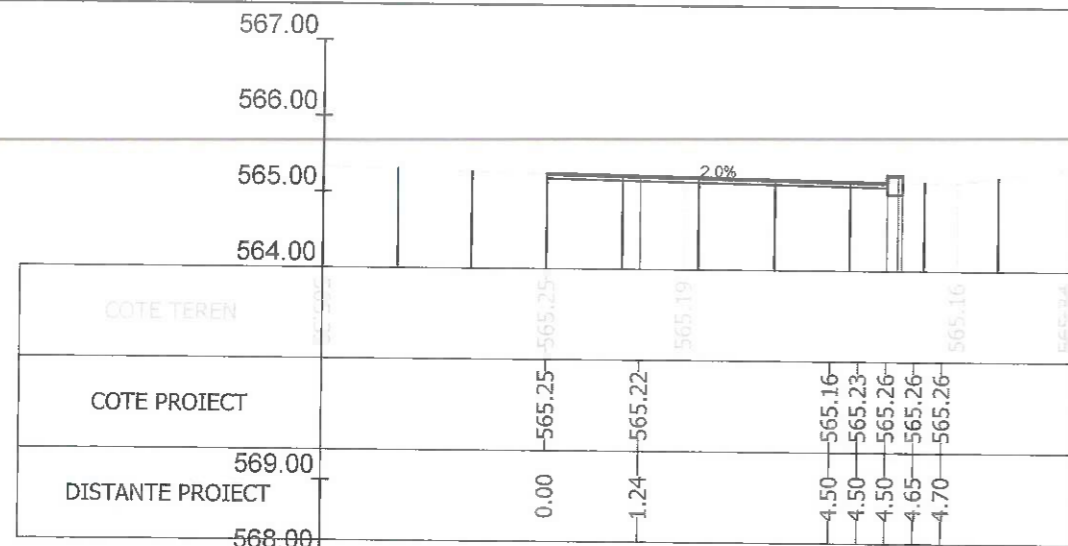

Sectiunea 96 - Km 1+550
Ax-Traseul 2

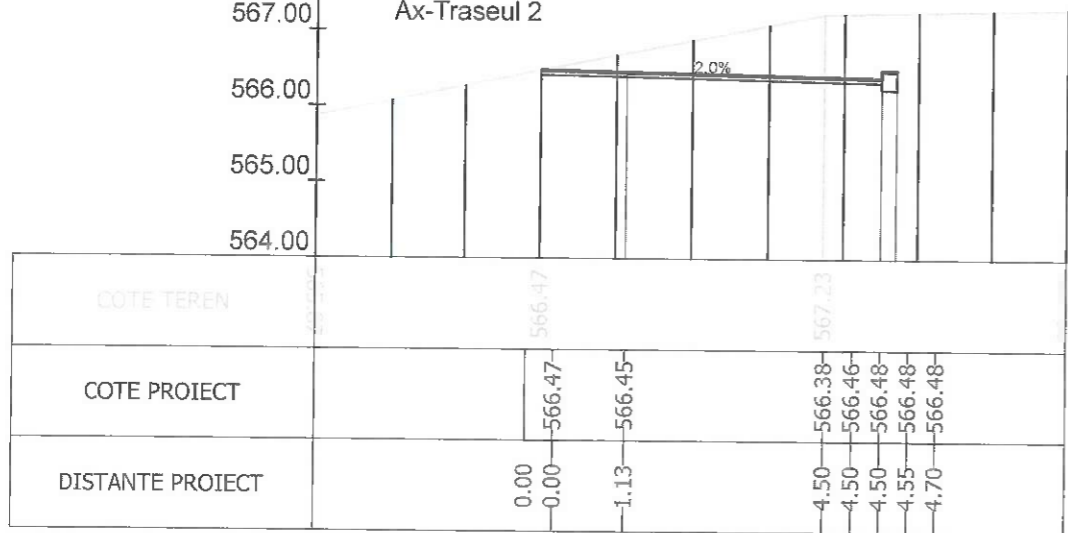

Sectiunea 98 - Km 1+575
Ax-Traseul 2

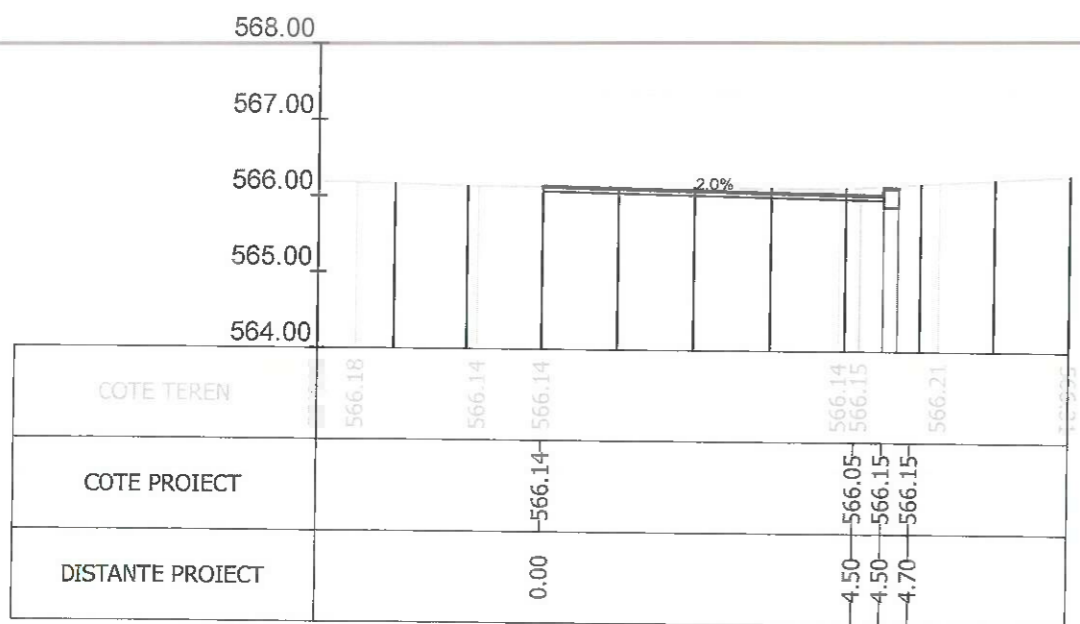

Sectiunea 100 - Km 1+600
Ax-Traseul 2

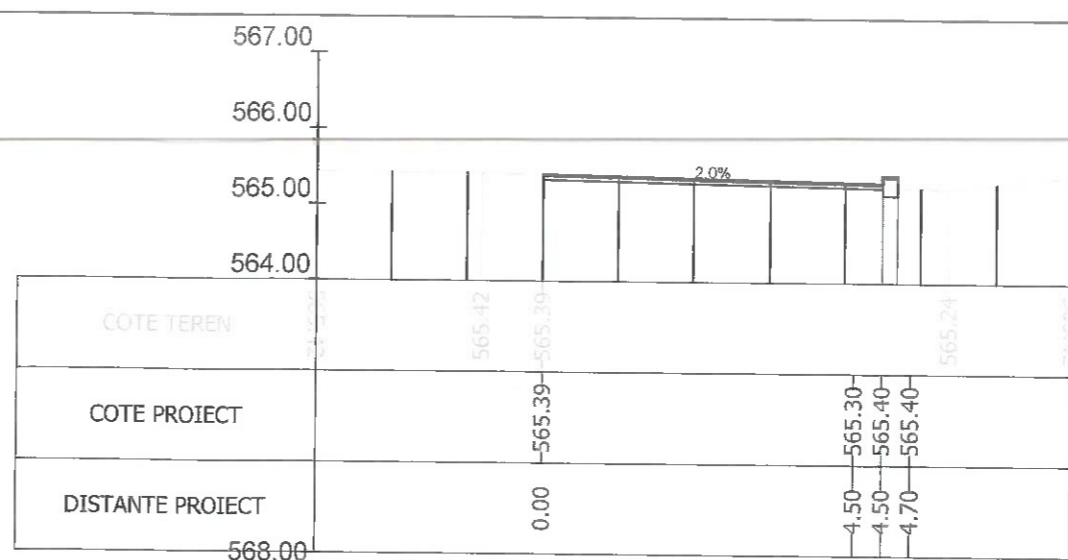

Sectiunea 97 - Km 1+552.215
Ax-Traseul 2

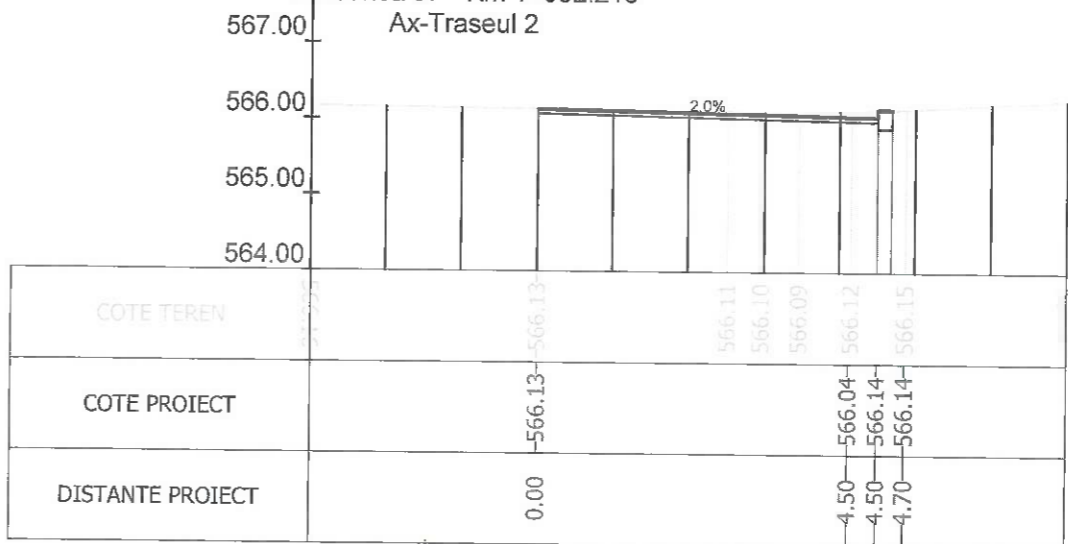

Sectiunea 99 - Km 1+597.045
Ax-Traseul 2

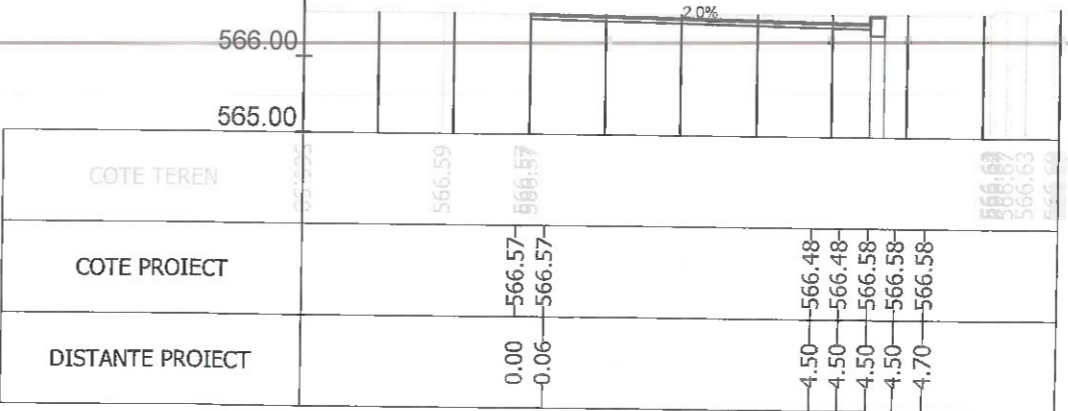

Sectiunea 101 - Km 1+625
Ax-Traseul 2

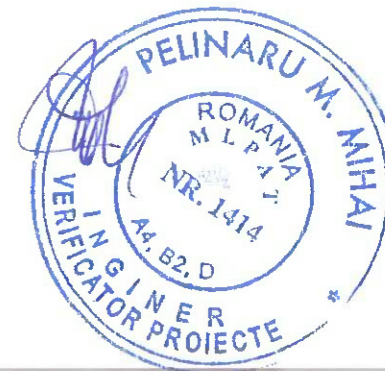

Index	A		Rev. 5
			Beneficiar: MUNICIPIUL BRASOV Bulevardul Eroilor 8, Brasov 500007
Sef Proiect	Ing. A. Buta	Scara	Nr. proiect
Proiectat	Ing. A. Buta	1/100	73 / 2020
Desenat	Ing. S. Patroi	Data	Faza
Verificat		07/2023	P.T.
			Tytu proiect: AMENAJARE BENZI DEDICATE TRANSPORTULUI PUBLIC IN MUNICIPIUL BRASOV SI TROTUARE ADIACENTE
			Tytu plansa: PROFILE TRANSVERSALE CURENTE
			Nr. plansa PT-77

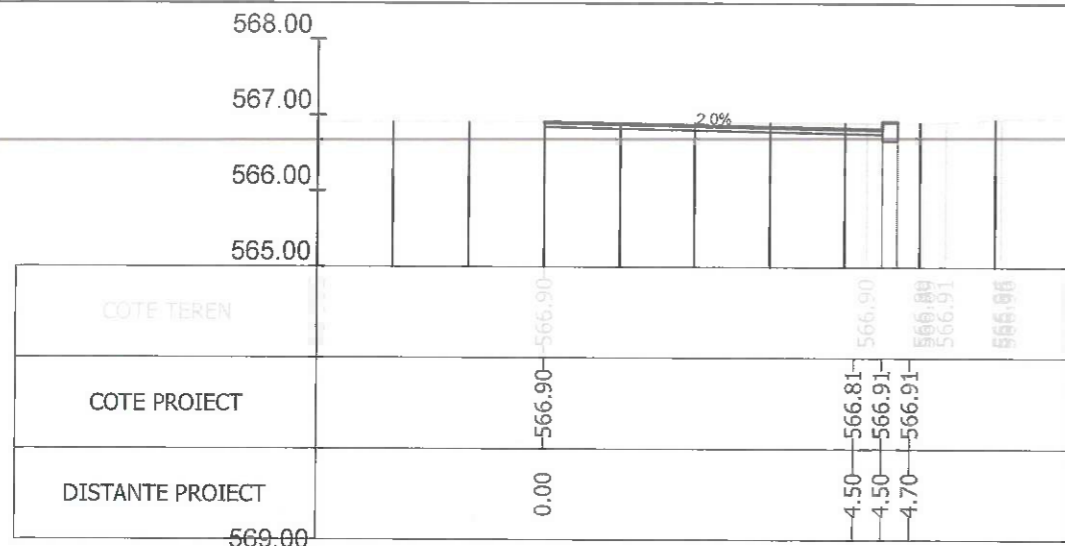

Sectiunea 102 - Km 1+641.875
Ax-Traseul 2

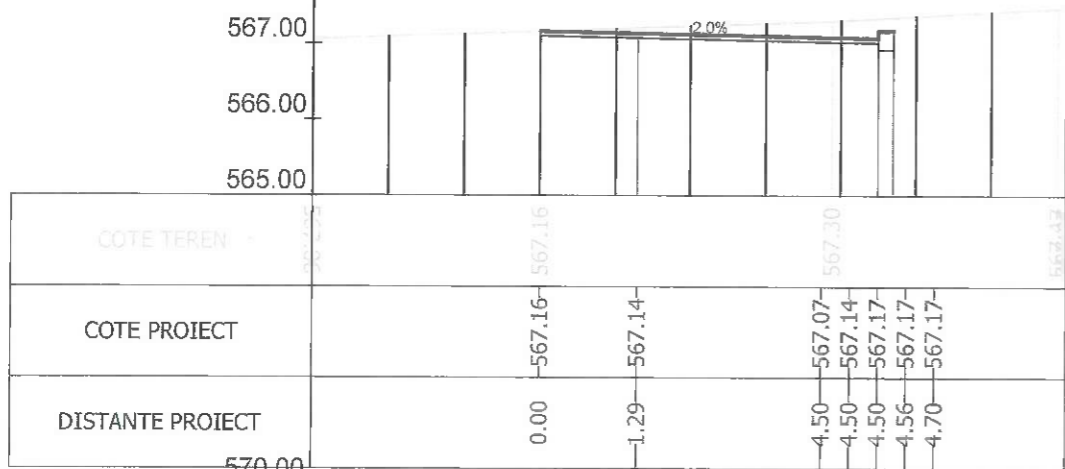

Sectiunea 103 - Km 1+650
Ax-Traseul 2

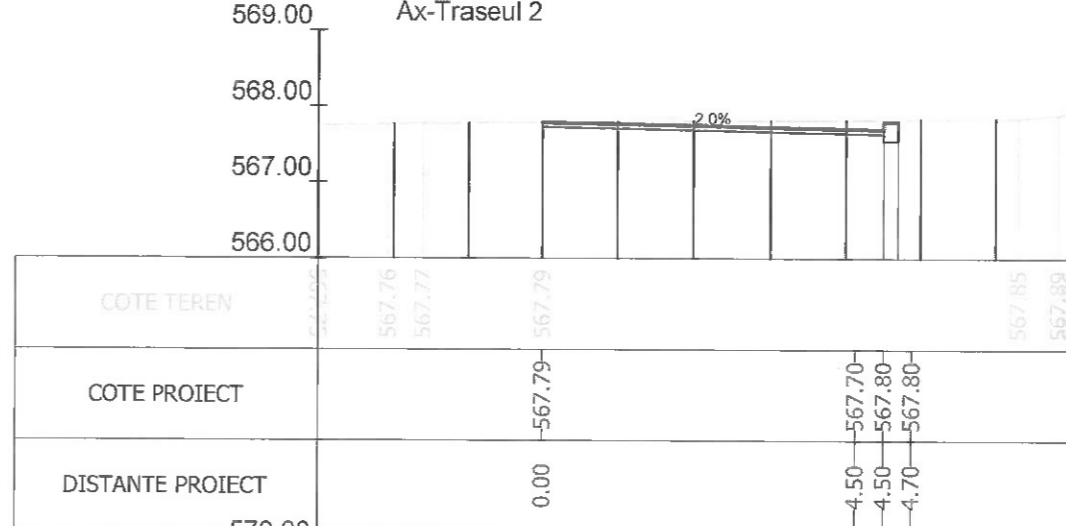

Sectiunea 104 - Km 1+675
Ax-Traseul 2

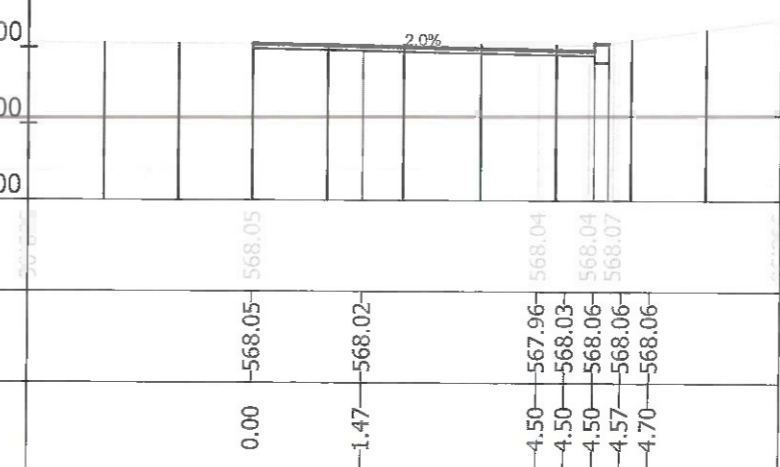
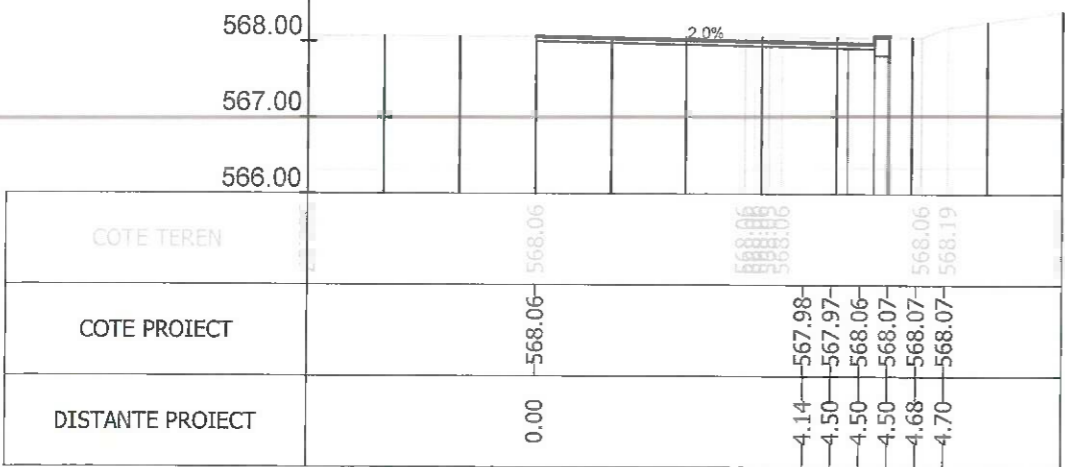

Sectiunea 105 - Km 1+700
Ax-Traseul 2

Sectiunea 106 - Km 1+722.570
Ax-Traseul 2



Index	A	Data	07/2023	Rev. 5
		Beneficiar: MUNICIPIUL BRASOV Bulevardul Eroilor 8, Brasov 500007		Nr. proiect 73 / 2020
Sef Proiect: Ing. A. Buta Proiectat: Ing. A. Buta Desenat: Ing. S. Patroi Verificat:		Scara: 1/100 Data: 07/2023		Faza: P.T. Nr. planșa: PT-78
Titlu proiect: AMENAJARE BENZI DEDICATE TRANSPORTULUI PUBLIC IN MUNICIPIUL BRASOV SI TROTUARE ADIACENTE		Titlu planșa: PROFILE TRANSVERSALE CURENTE		

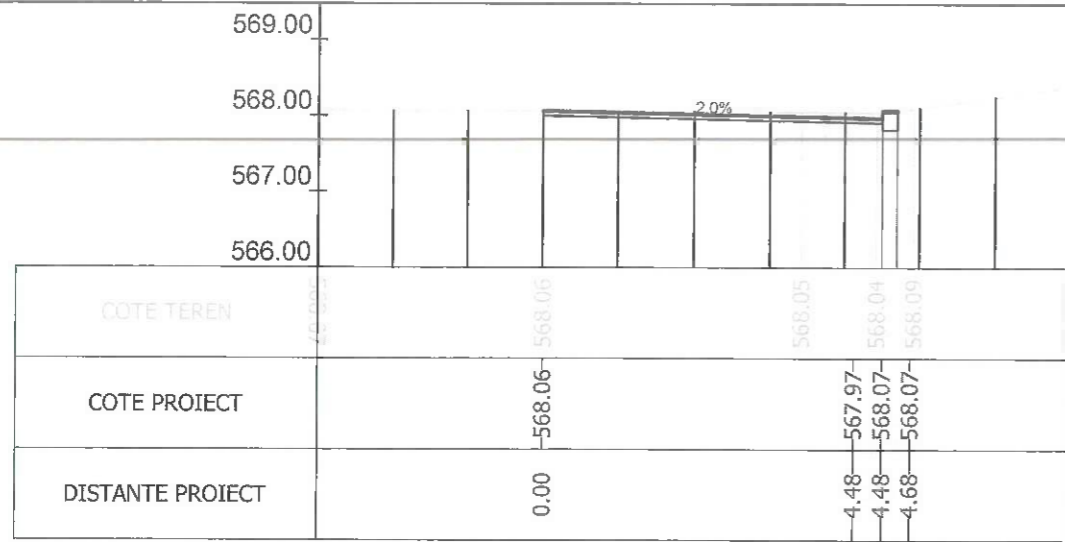

Sectiunea 108 - Km 1+725.215
Ax-Traseul 2

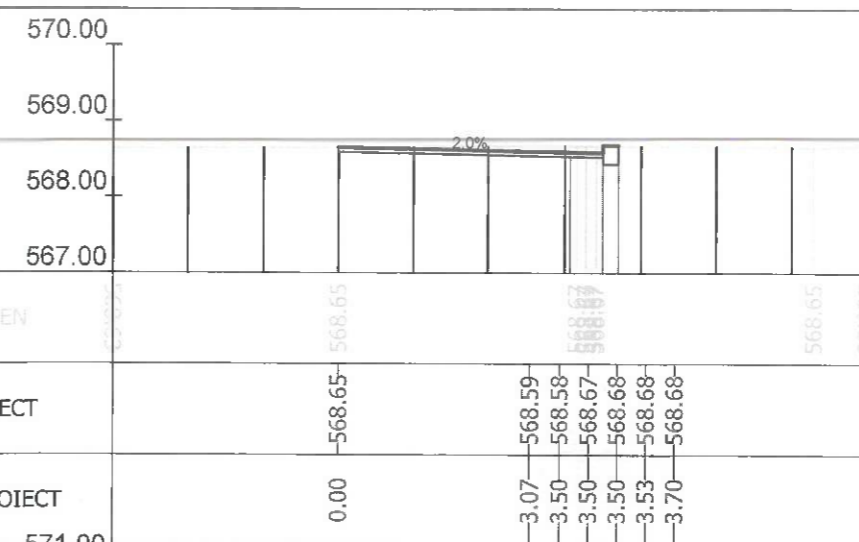
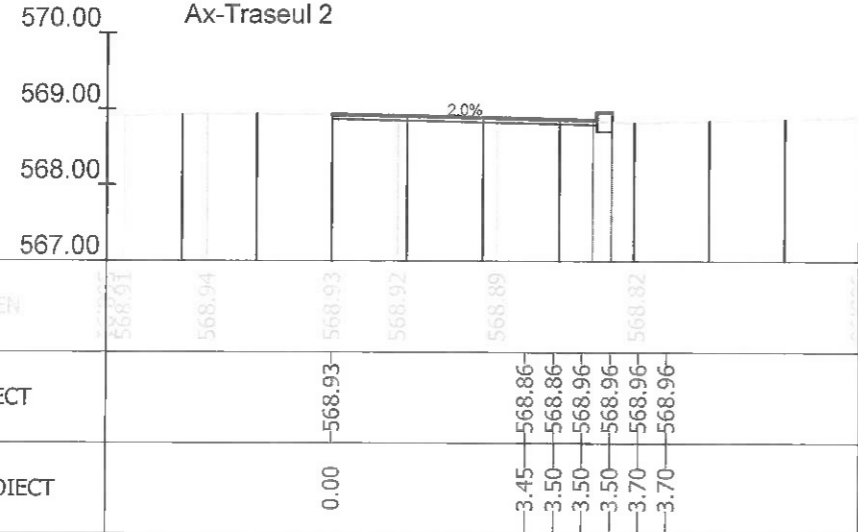

Sectiunea 110 - Km 1+750
Ax-Traseul 2

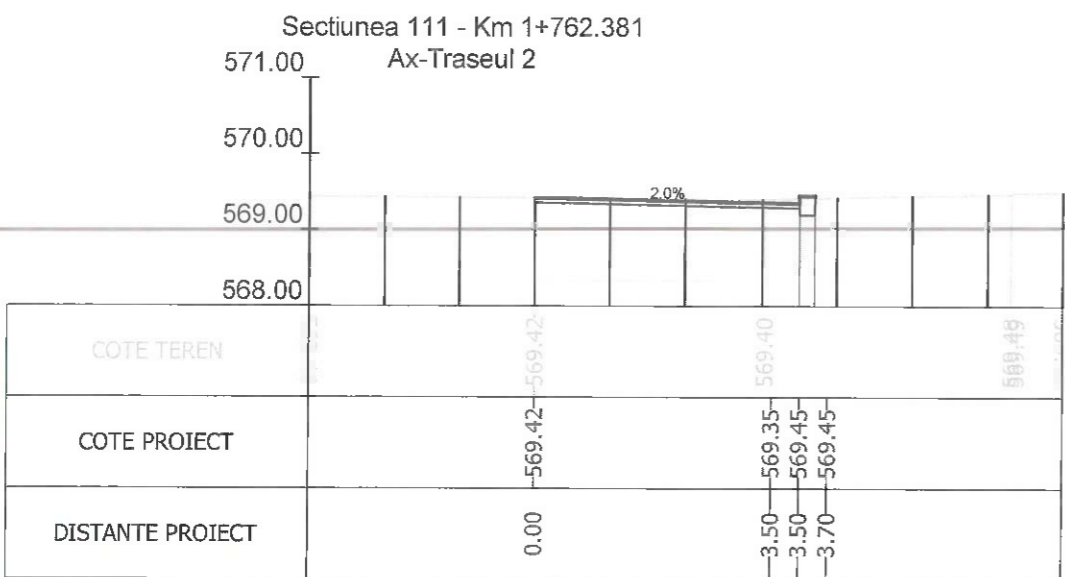
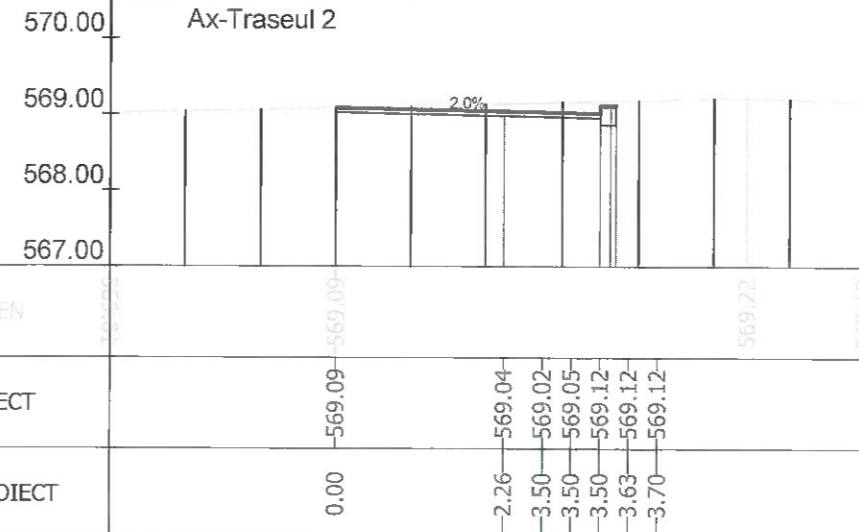

Sectiunea 111 - Km 1+762.381
Ax-Traseul 2

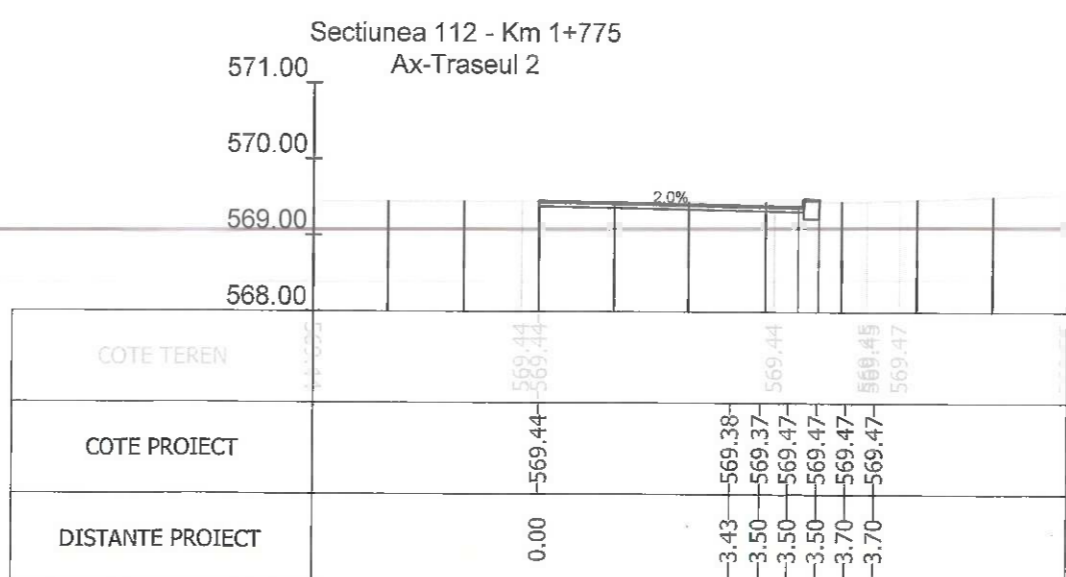

Sectiunea 112 - Km 1+775
Ax-Traseul 2

Index	Data	Rev. 5
A		
		Beneficiar: MUNICIPIUL BRASOV Bulevardul Eroilor 8, Brasov 500007
Sef Proiect	Ing. A. Buta	Nr. proiect 73 / 2020
Proiectat	Ing. A. Buta	Faza P.T.
Desenat	Ing. S. Patroi	Tytu plansa: PROFILE TRANSVERSALE CURENTE
Verificat		Nr. plansa PT-79
Scara 1/100		
Data 07/2023		

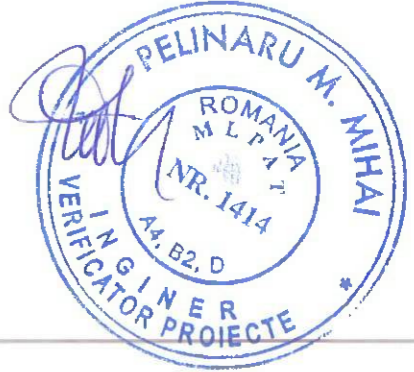

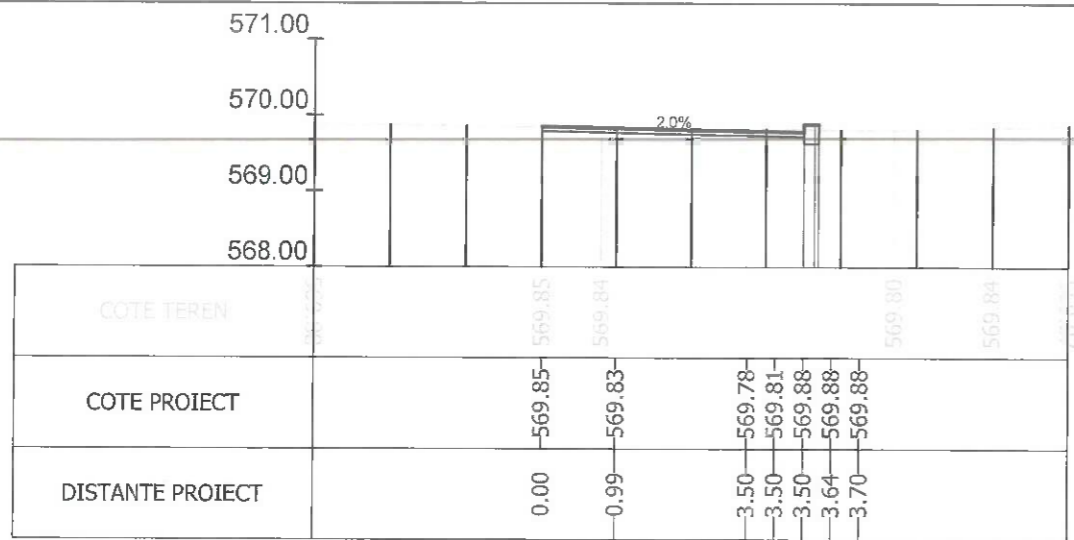

Sectiunea 115 - Km 1+825
Ax-Traseul 2

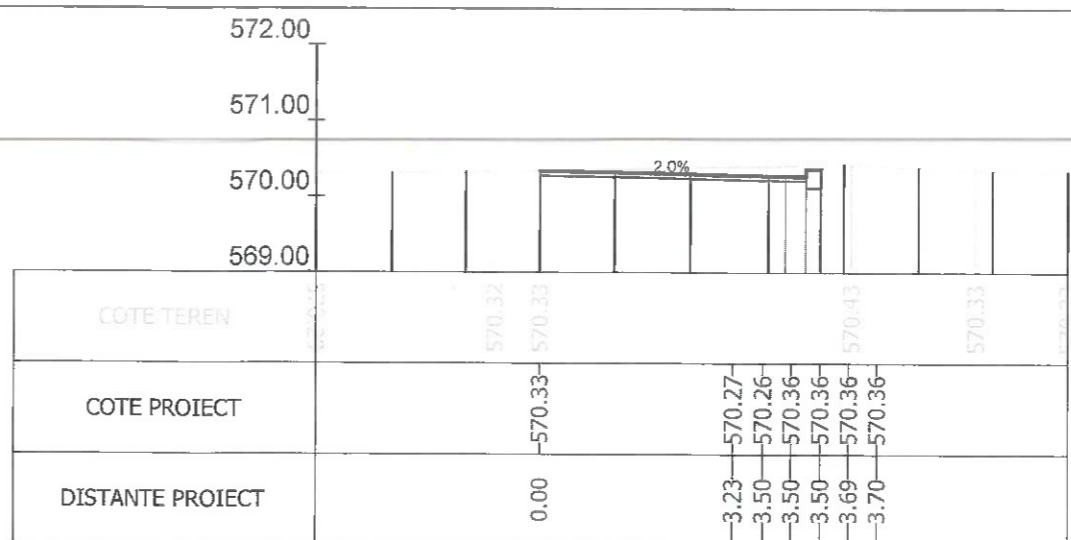

Sectiunea 116 - Km 1+850
Ax-Traseul 2

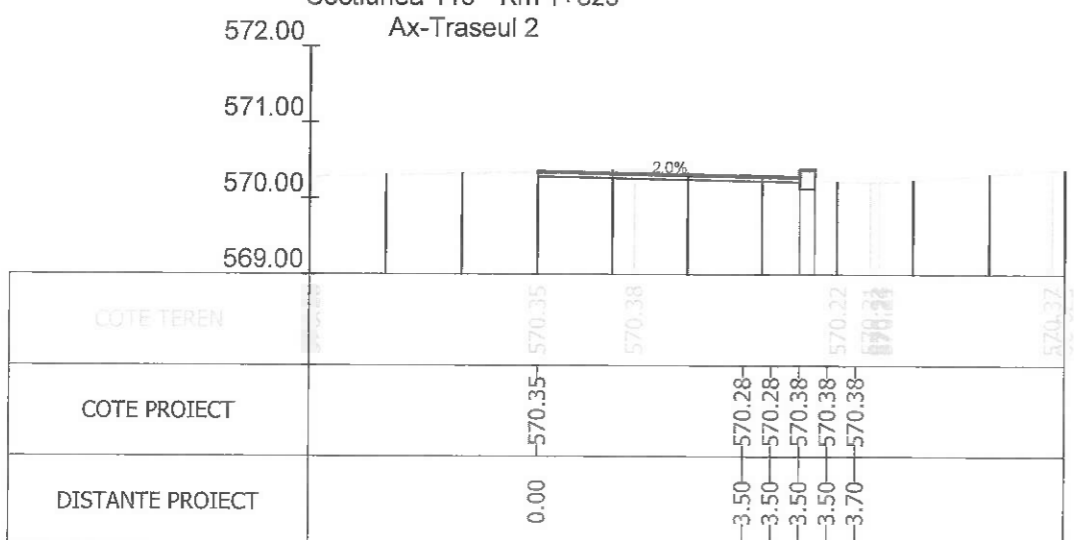

Sectiunea 117 - Km 1+856.162
Ax-Traseul 2

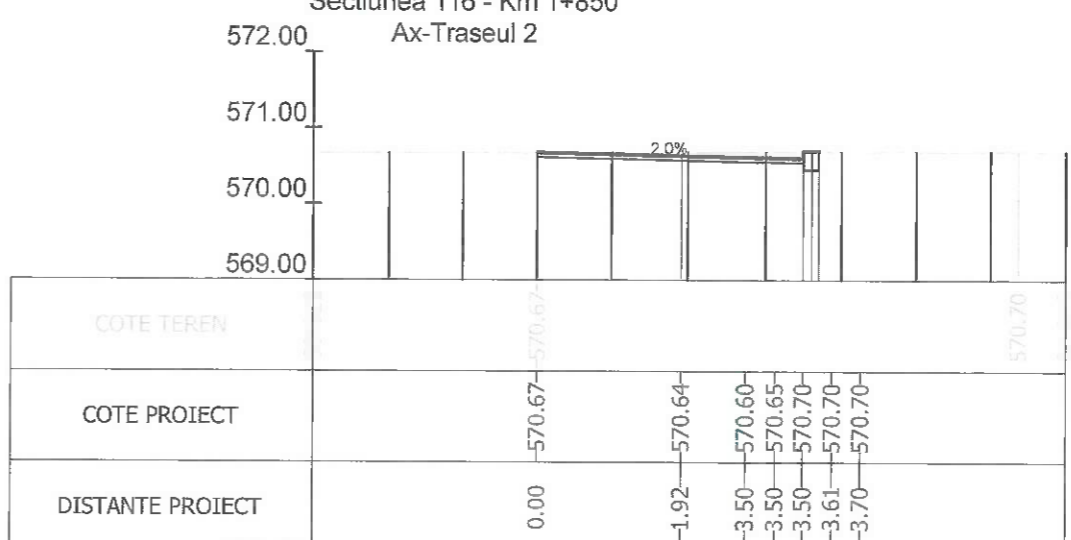

Sectiunea 118 - Km 1+875
Ax-Traseul 2

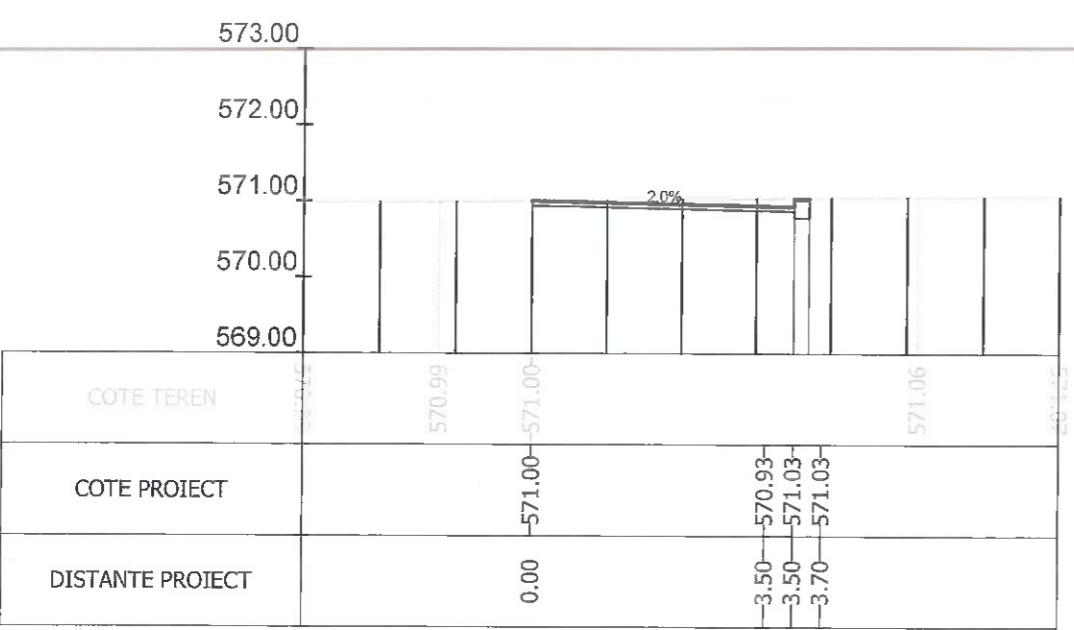

Sectiunea 119 - Km 1+900
Ax-Traseul 2

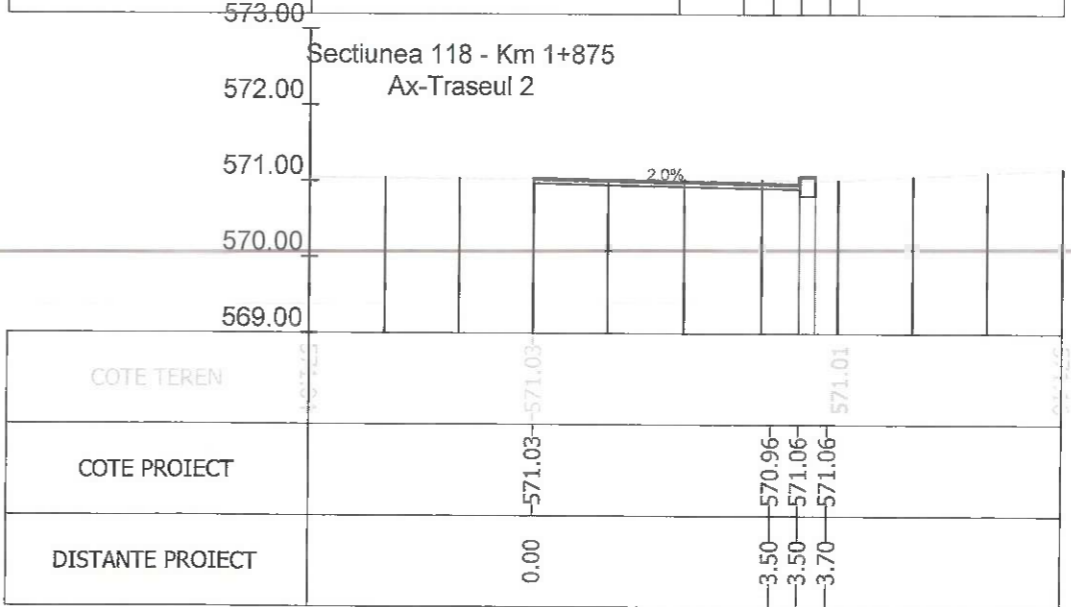

Sectiunea 120 - Km 1+906.130
Ax-Traseul 2



Index	A		Rev. 5
			Beneficiar: MUNICIPIUL BRASOV Bulevardul Eroilor 8, Brasov 500007
Sef Proiect: Ing. A. Buta Proiectat: Ing. A. Buta Desenat: Ing. S. Patroi Verificat:			Nr. proiect: 73 / 2020 Faza P.T. Nr. plansa: PT-80
Scara: 1/100 Data: 07/2023			Titlu proiect: AMENAJARE BENZI DEDICATE TRANSPORTULUI PUBLIC IN MUNICIPIUL BRASOV SI TROTUARE ADIACENTE Titlu plansa: PROFILE TRANSVERSALE CURENTE

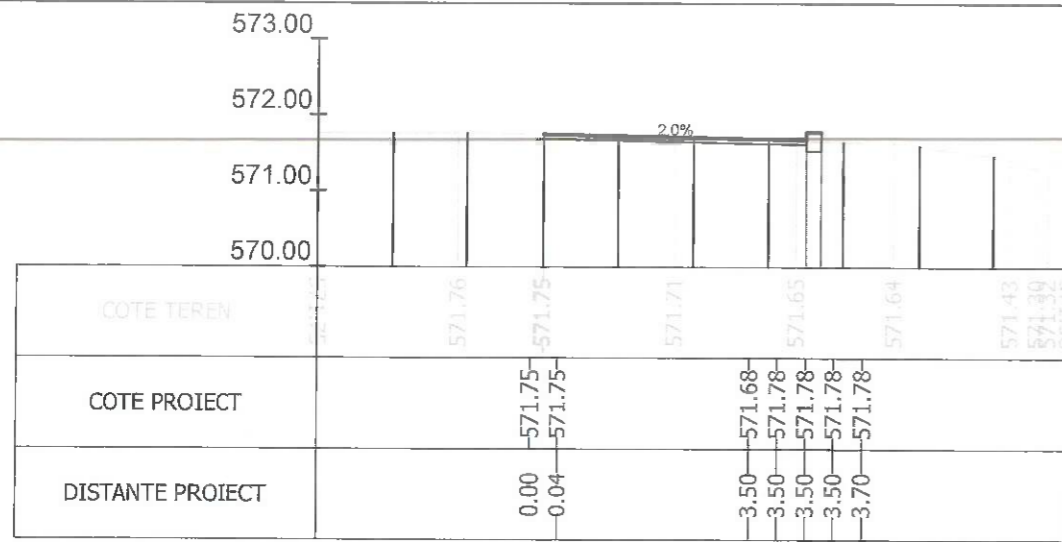

Sectiunea 121 - Km 1+925
Ax-Traseul 2

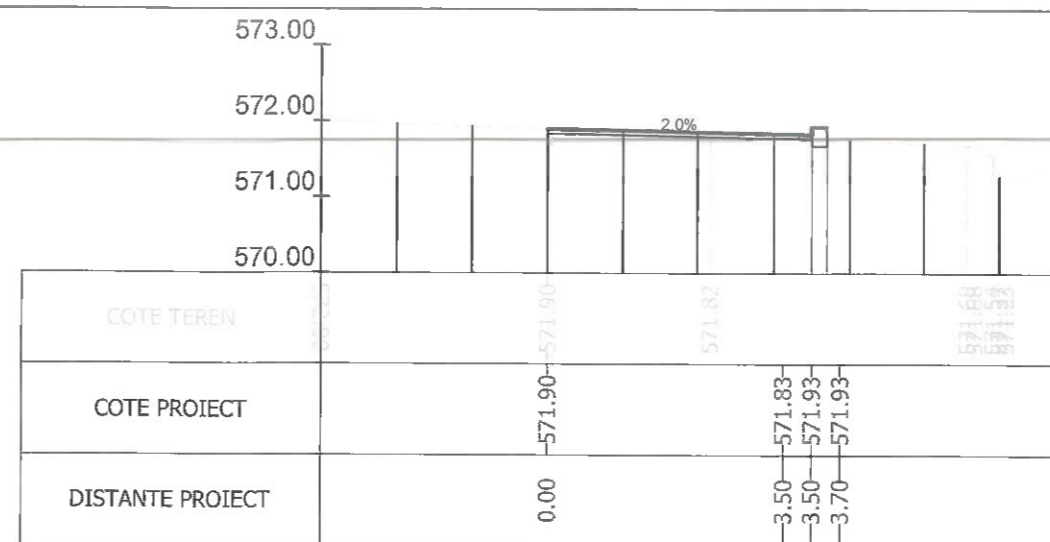

Sectiunea 122 - Km 1+933.733
Ax-Traseul 2

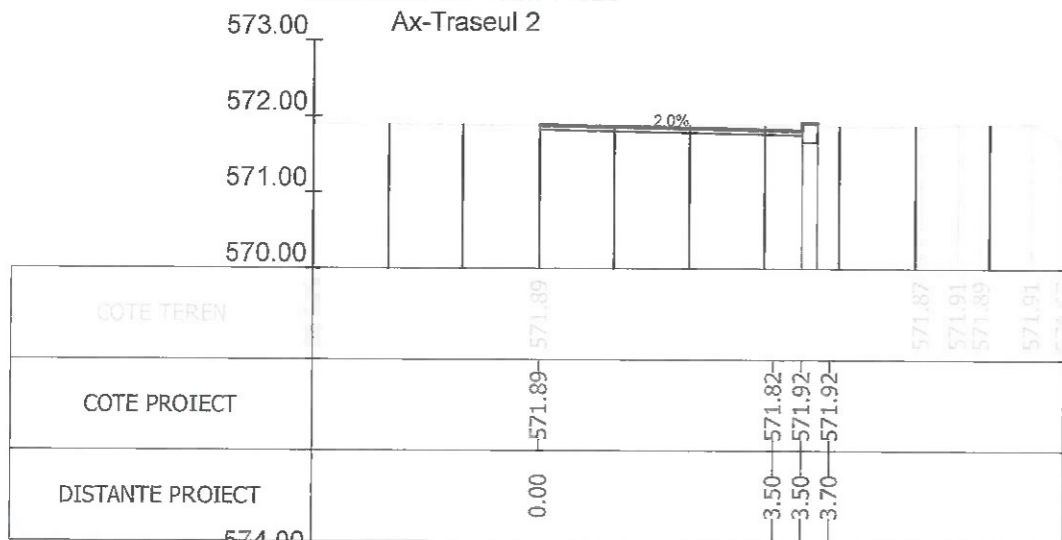

Sectiunea 123 - Km 1+946.315
Ax-Traseul 2

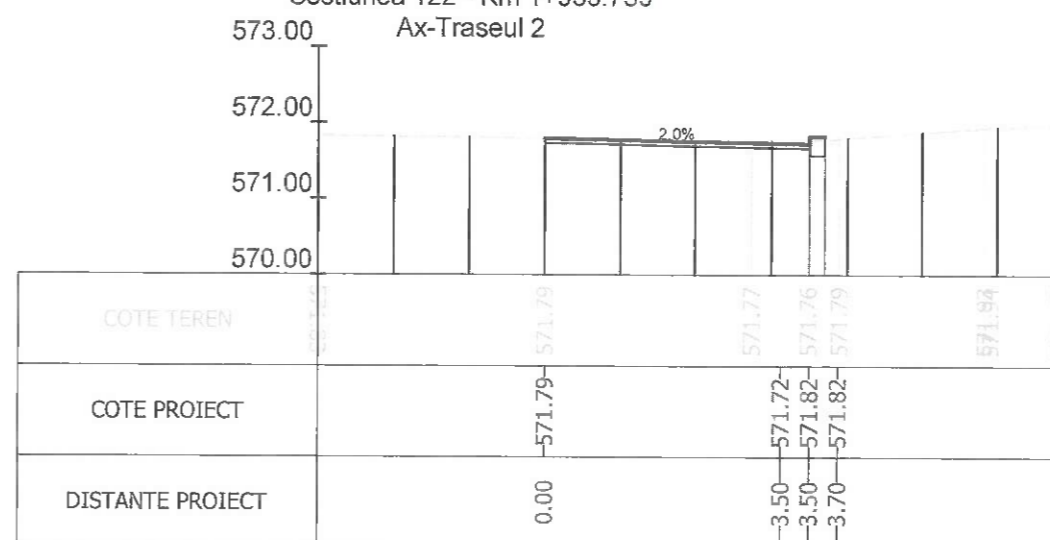

Sectiunea 124 - Km 1+950
Ax-Traseul 2

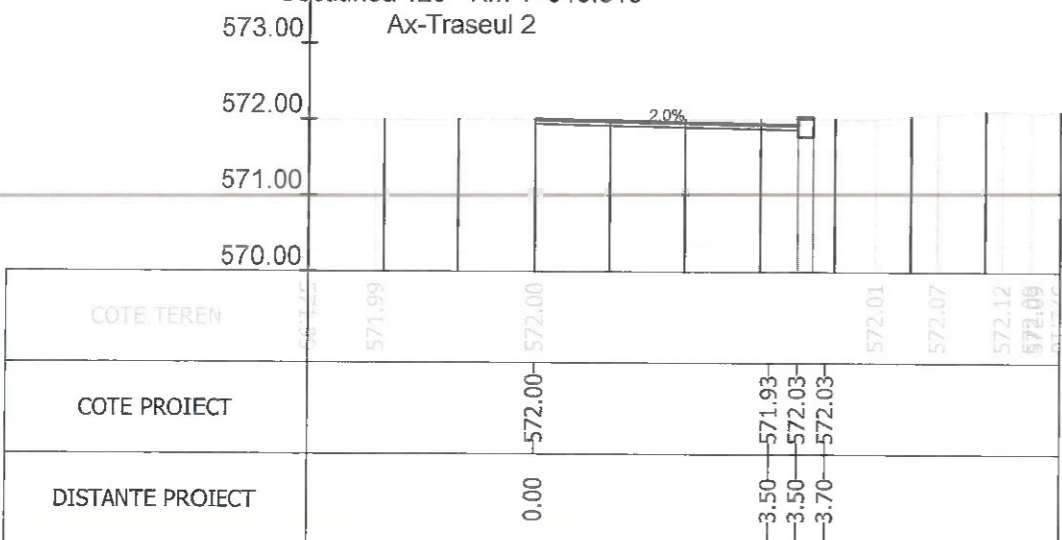

Sectiunea 125 - Km 1+958.897
Ax-Traseul 2

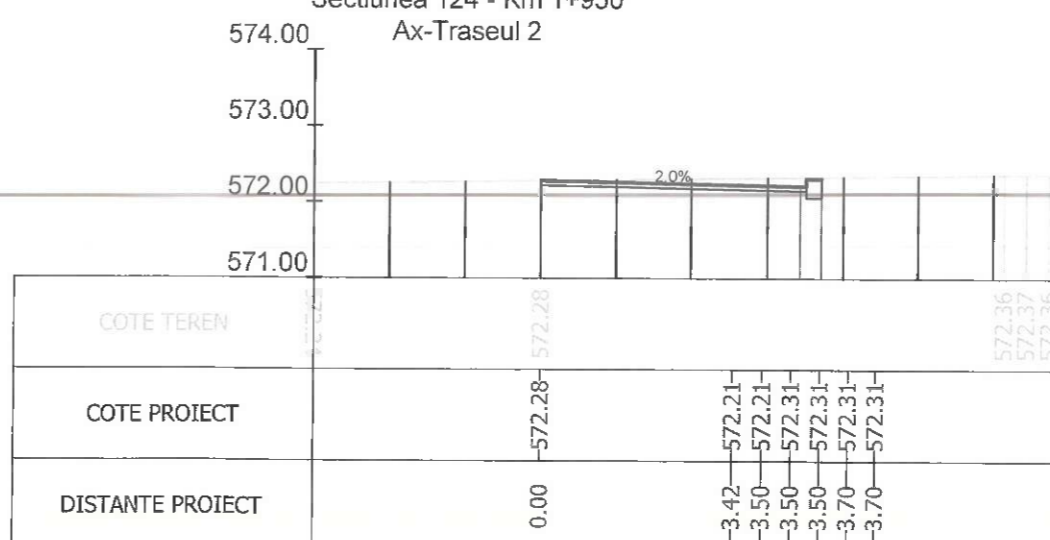

Sectiunea 126 - Km 1+971.988
Ax-Traseul 2

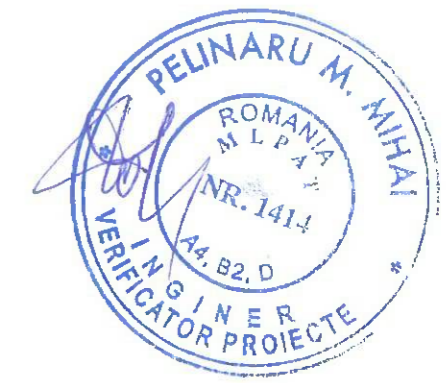

Index	A		Rev. 5
			Beneficiar: MUNICIPIUL BRASOV Bulevardul Eroilor 8, Brasov 500007
Sef Proiect: Ing. A. Buta Proiectat: Ing. A. Buta Desenat: Ing. S. Patroi Verificat:			Nr. proiect: 73 / 2020 Faza: P.T. Nr. plansa: PT-81
Scara: 1/100 Data: 07/2023			Titlu proiect: AMENAJARE BENZI DEDICATE TRANSPORTULUI PUBLIC IN MUNICIPIUL BRASOV SI TROTUARE ADIACENTE Titlu plansa: PROFILE TRANSVERSALE CURENTE

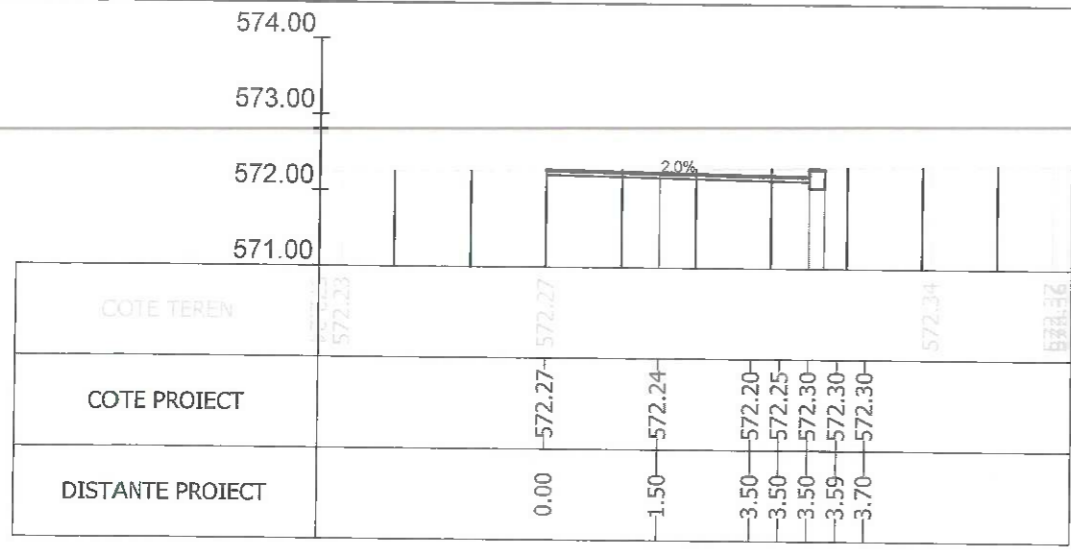

Sectiunea 127 - Km 1+975
Ax-Traseul 2

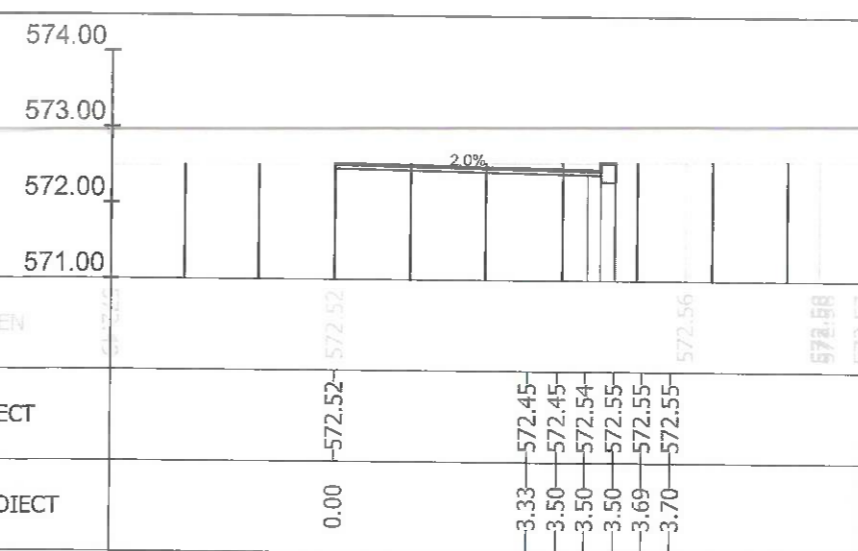
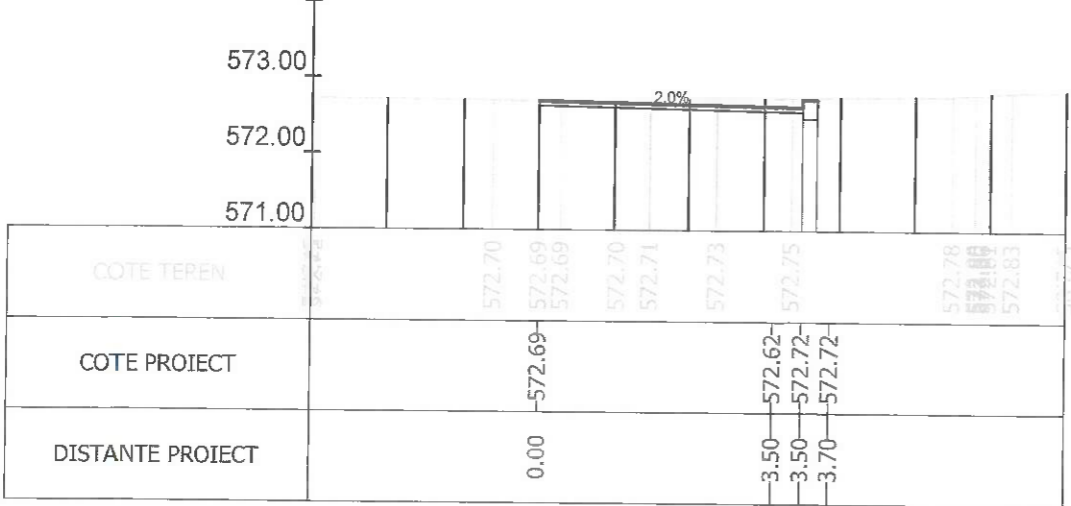

Sectiunea 128 - Km 1+985.541
Ax-Traseul 2

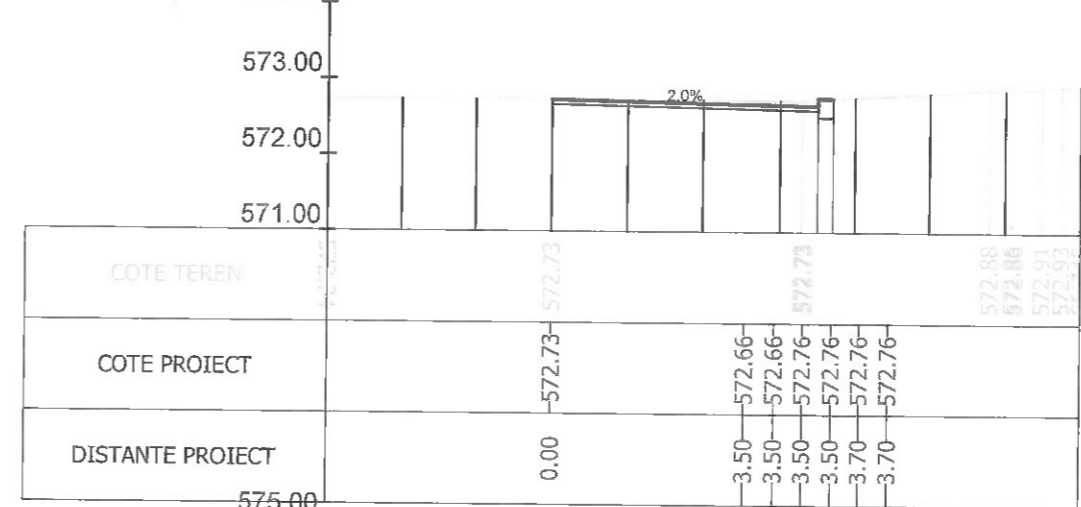

Sectiunea 129 - Km 2+000
Ax-Traseul 2

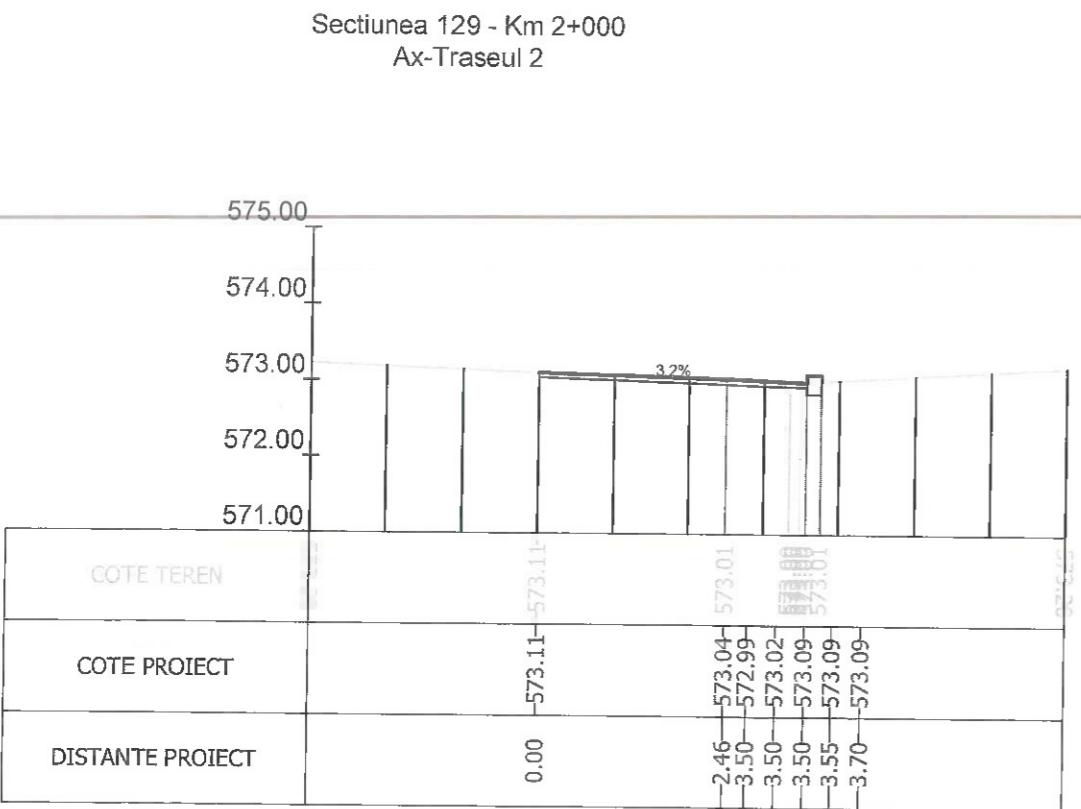

Sectiunea 130 - Km 2+004.732
Ax-Traseul 2

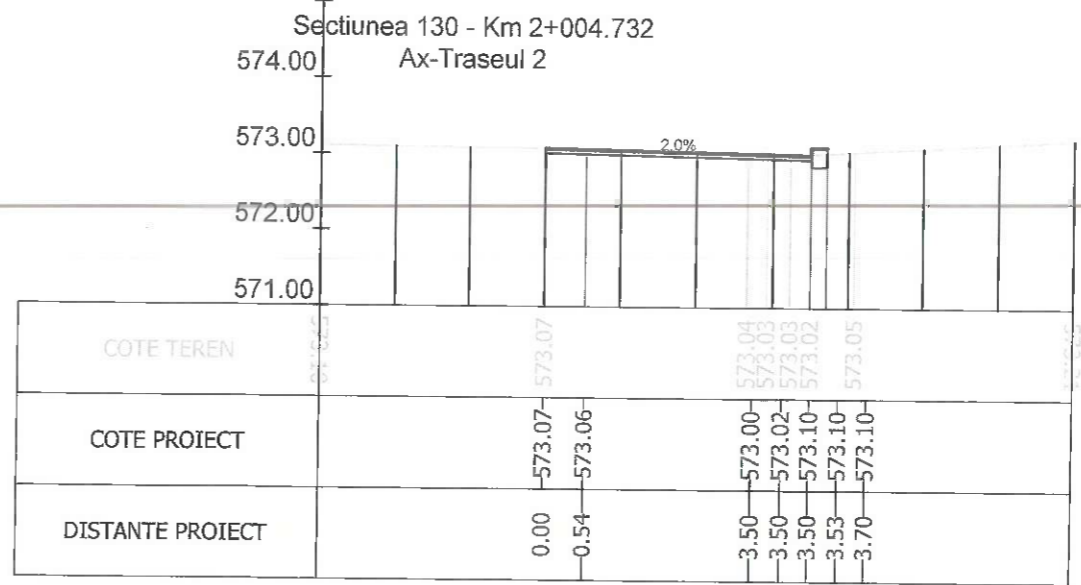

Sectiunea 131 - Km 2+023.600
Ax-Traseul 2

Index	A		Rev. 5
			Beneficiar:
			MUNICIPIUL BRASOV Bulevardul Eroilor 8, Brasov 500007
			Nr. proiect
			73 / 2020
			Titlu proiect:
			AMENAJARE BENZI DEDICATE TRANSPORTULUI PUBLIC IN MUNICIPIUL BRASOV SI TROTUARE ADIACENTE
			Faza
			P.T.
			Titlu plansa:
			PROFILI TRANSVERSALE CURENTE
			Nr. plansa
			PT-82
Sef Proiect	Ing. A. Buta		Scara
Proiectat	Ing. A. Buta		1/100
Desenat	Ing. S. Patroi		Data
Verificat			07/2023



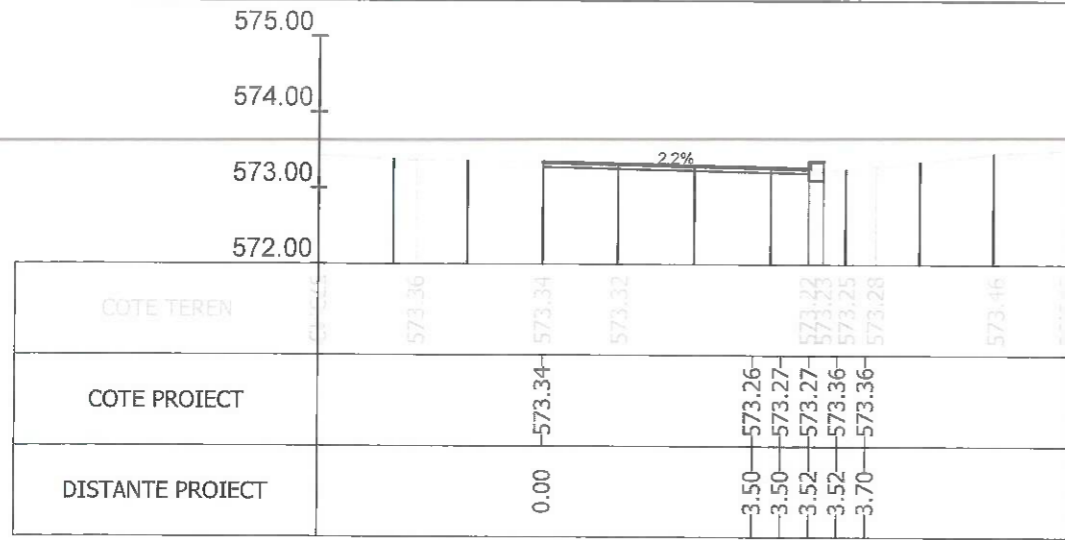

Sectiunea 133 - Km 2+033.664
Ax-Traseul 2

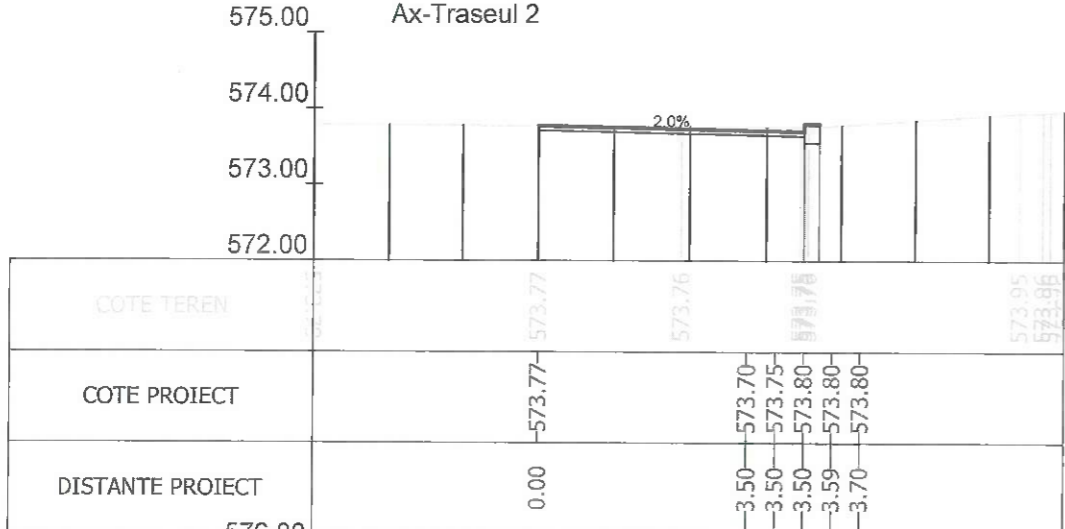

Sectiunea 134 - Km 2+050
Ax-Traseul 2

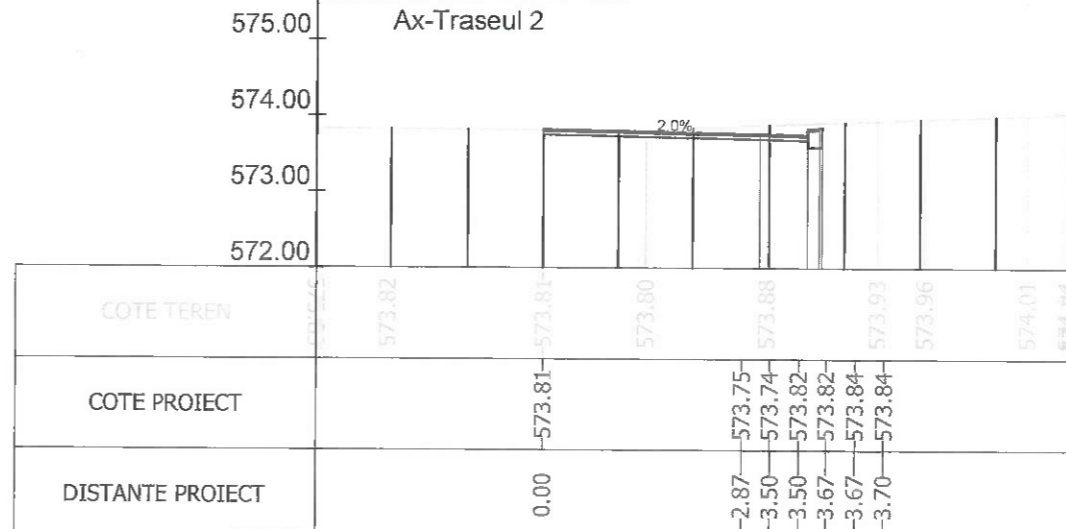

Sectiunea 135 - Km 2+069.815
Ax-Traseul 2

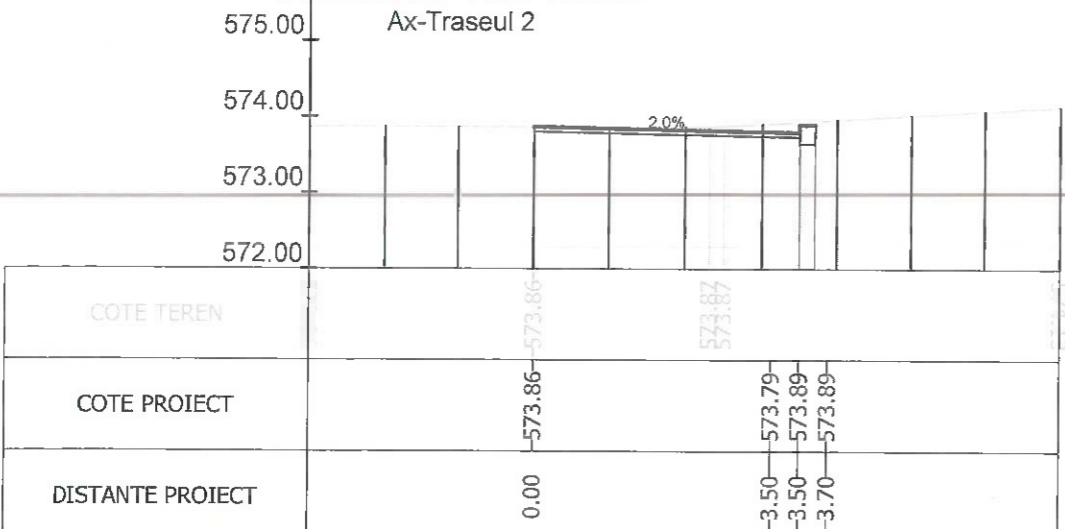

Sectiunea 136 - Km 2+075
Ax-Traseul 2

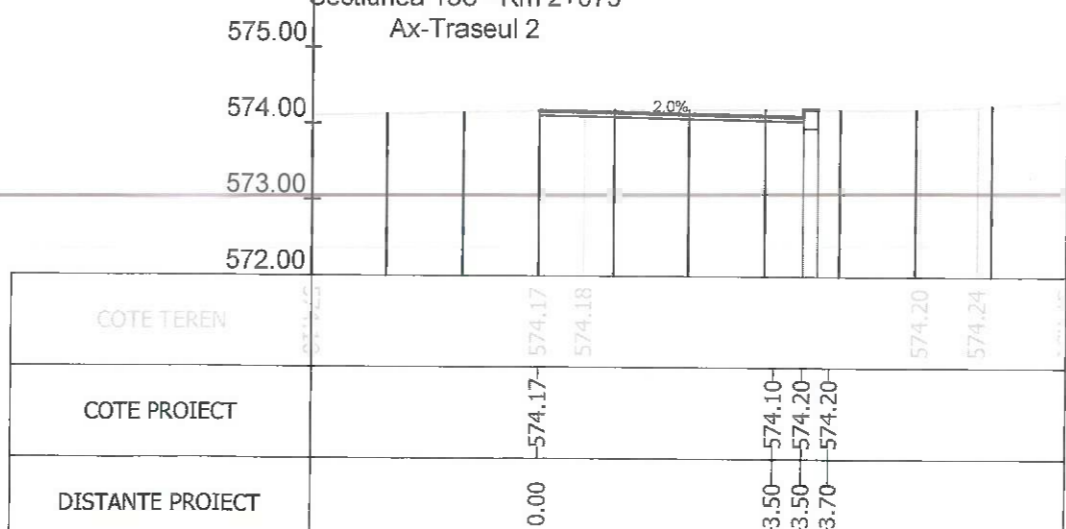

Sectiunea 137 - Km 2+080.207
Ax-Traseul 2

Sectiunea 138 - Km 2+088.980

Index	Data	Rev. 5
A		
		Beneficiar: MUNICIPIUL BRASOV Bulevardul Eroilor 8, Brasov 500007
Sef Proiect	Ing. A. Buta	Nr. proiect 73 / 2020
Proiectat	Ing. A. Buta	Faza P.T.
Desenat	Ing. S. Patroi	Tytu planşa: PROFILE TRANSVERSALE CURENTE
Verificat		Nr. planşa PT-83
Scara 1/100		
Data 07/2023		

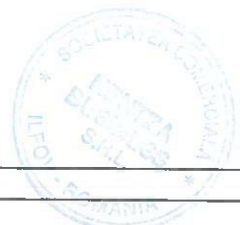

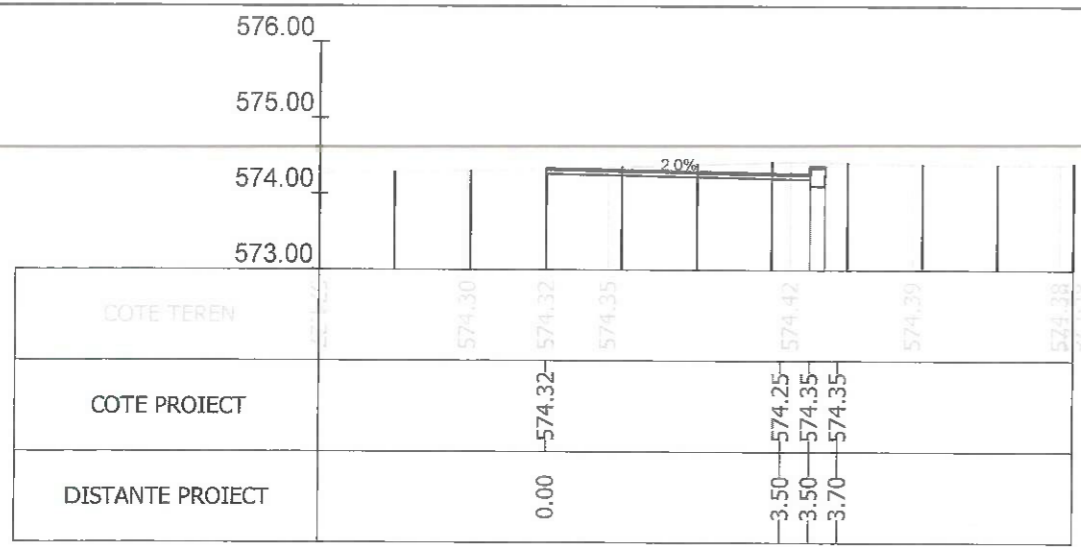

Sectiunea 139 - Km 2+097.753
Ax-Traseul 2

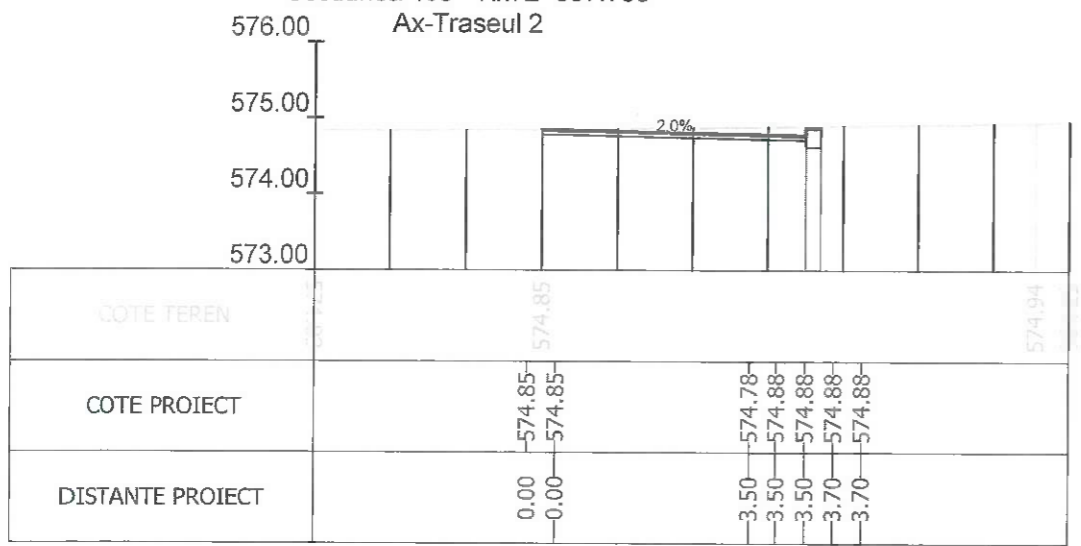

Sectiunea 141 - Km 2+125
Ax-Traseul 2

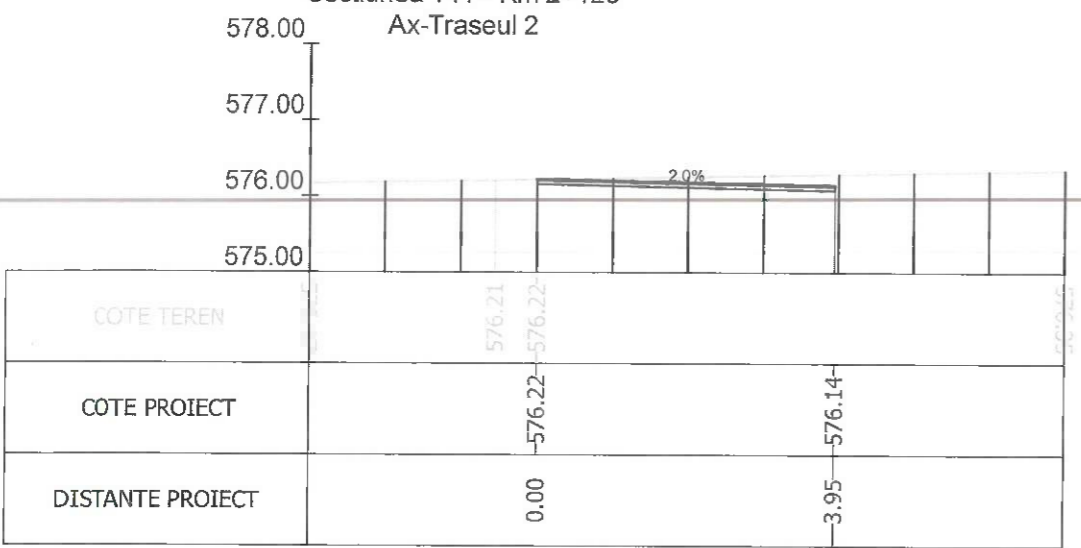

Sectiunea 146 - Km 2+197.733
Ax-Traseul 2

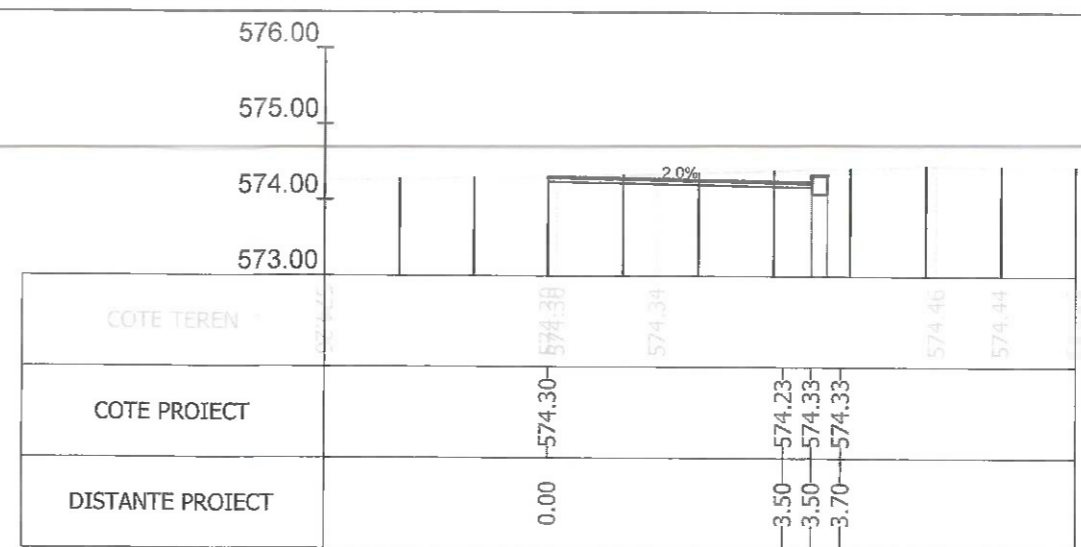

Sectiunea 140 - Km 2+100
Ax-Traseul 2

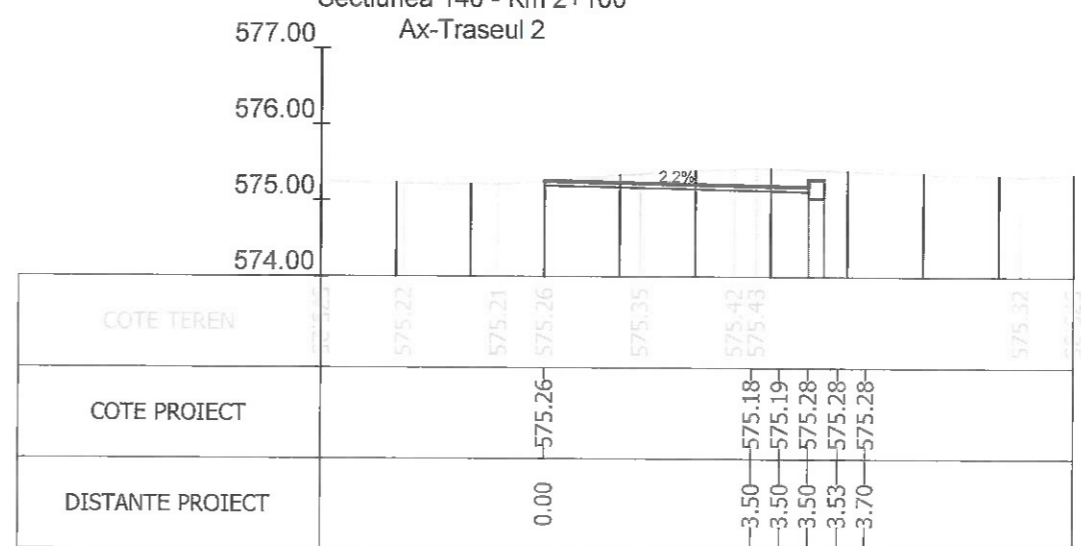

Sectiunea 142 - Km 2+144.542
Ax-Traseul 2

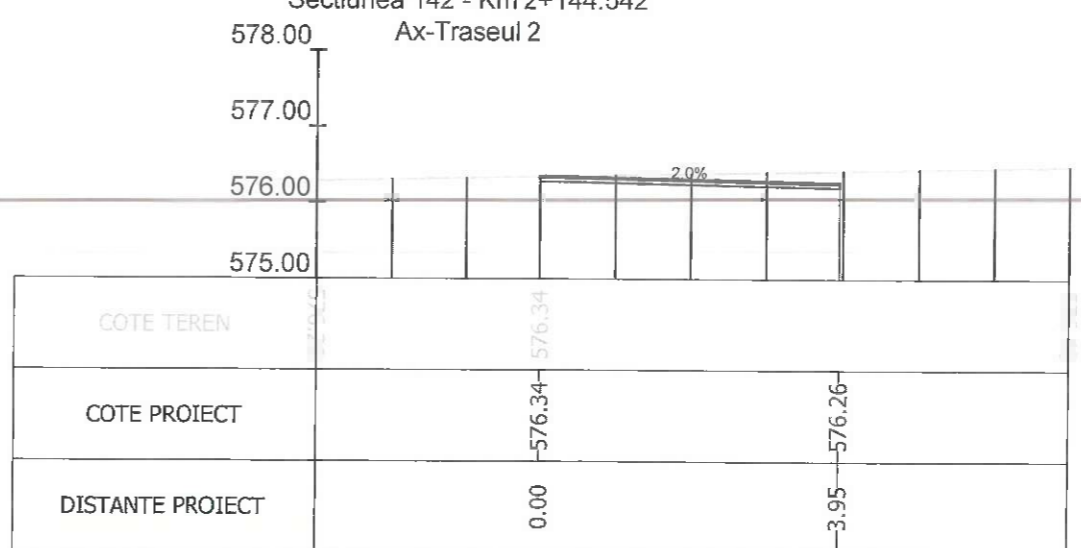

Sectiunea 147 - Km 2+200
Ax-Traseul 2



Index	A		Rev. 5
			Beneficiar: MUNICIPIUL BRASOV Bulevardul Eroilor 8, Brasov 500007
Sesi. Proiectantilor nr. 17 BUCURESTI NR. 3 EDIM 4, VOLUNTARI BUCURESTI, TEL. +40 37 494 0549, WWW.HENTZA.BUSINESS.RO			Nr. proiect 73 / 2020
Sef Proiect	Ing. A. Buta	Scara 1/100	Faza P.T.
Proiectat	Ing. A. Buta	Data	Tytu proiect: AMENAJARE BENZI DEDICATE TRANSPORTULUI PUBLIC IN MUNICIPIUL BRASOV SI TROTUARE ADIACENTE
Desenat	Ing. S. Patroi	07/2023	Tytu plansa: PROFILE TRANSVERSALE CURENTE
Verificat			Nr. plansa PT-84

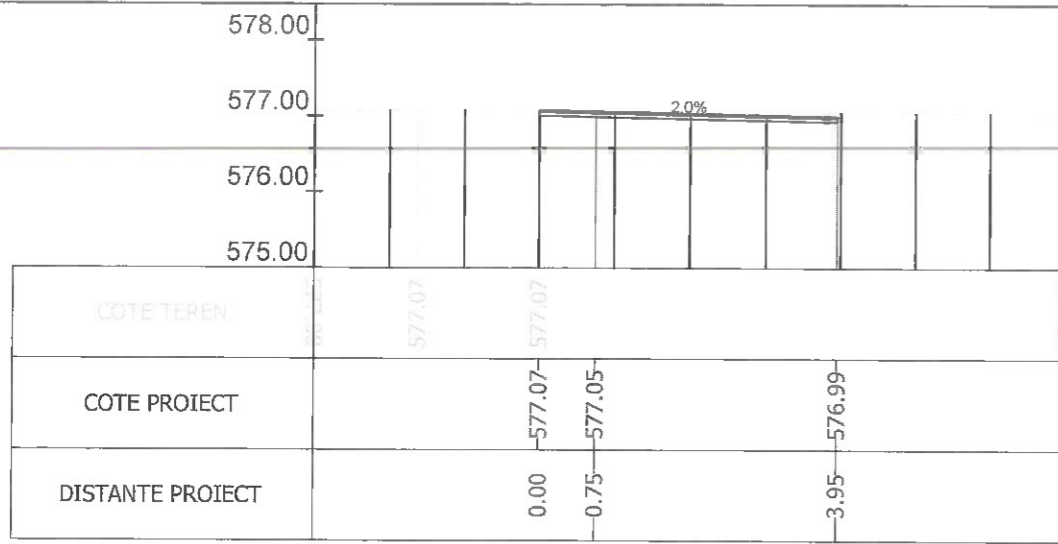

Sectiunea 148 - Km 2+225
Ax-Traseul 2

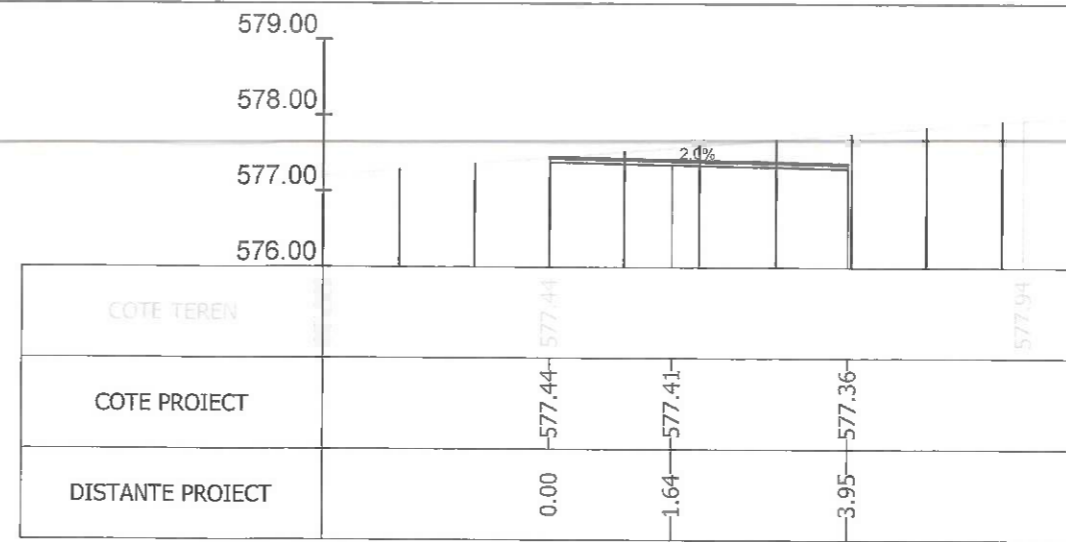

Sectiunea 149 - Km 2+250
Ax-Traseul 2

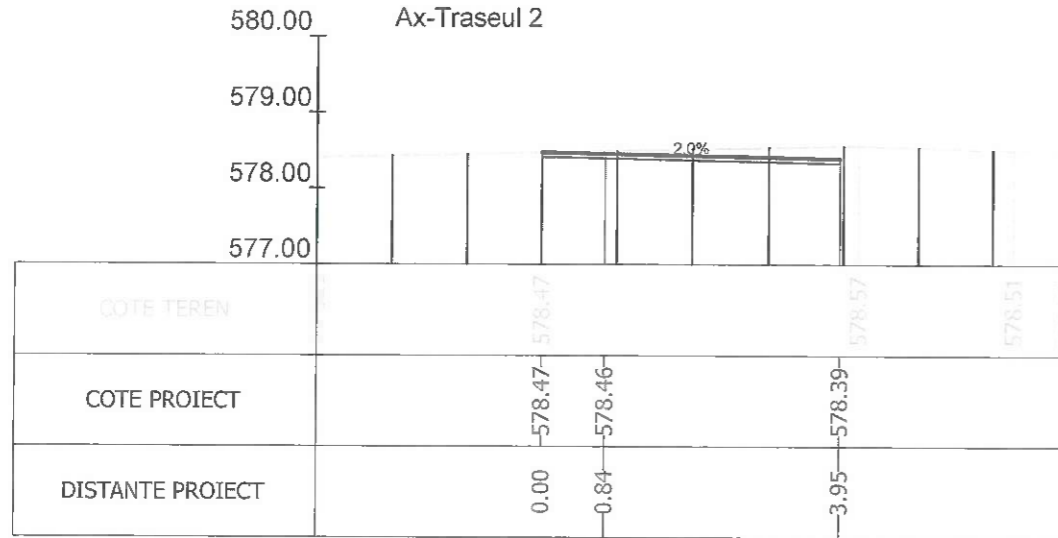

Sectiunea 150 - Km 2+275
Ax-Traseul 2

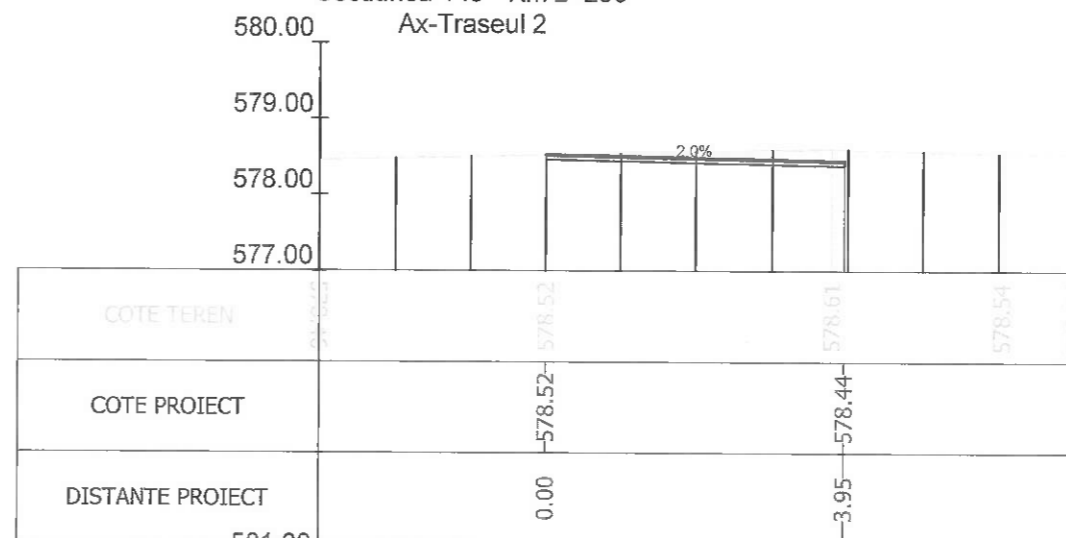

Sectiunea 151 - Km 2+276.350
Ax-Traseul 2

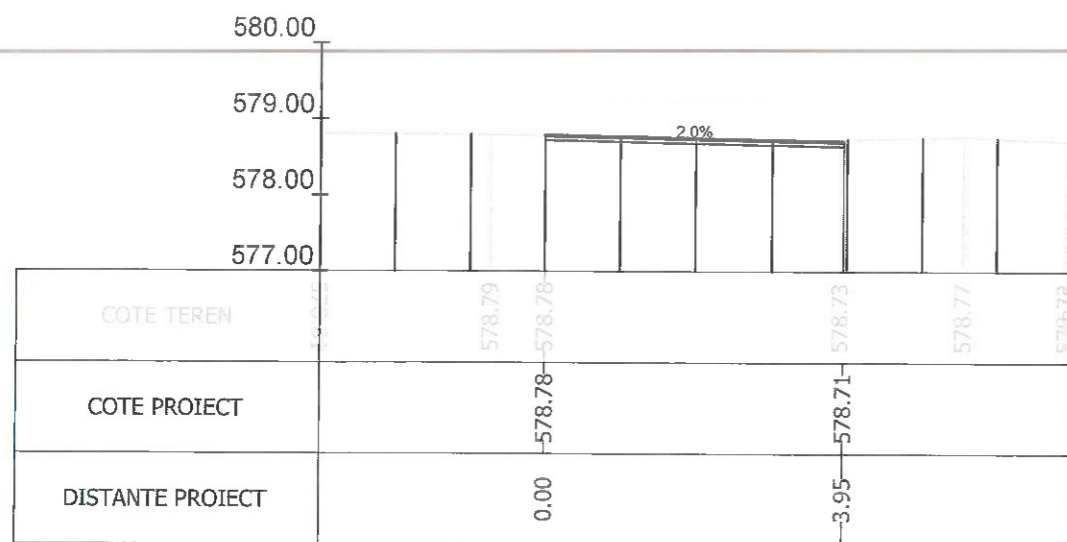

Sectiunea 152 - Km 2+286.877
Ax-Traseul 2

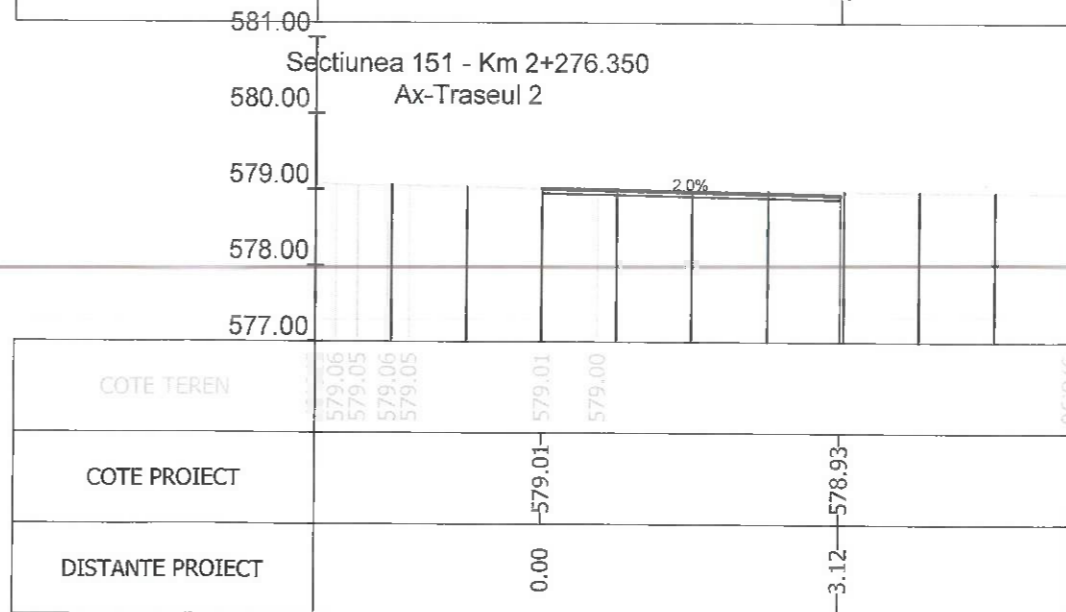

Sectiunea 153 - Km 2+297.404
Ax-Traseul 2



Index	Data	Observatii	Rev. 5
A			
		Beneficiar:	MUNICIPIUL BRASOV Bulevardul Eroilor 8, Brasov 500007
<small>SEEL PINDA-TURNOI NR. 17 BIROU NR. 3 ETALAJ 4, VOLUNTARI BRASOV, TEL: +403 37 406 040, EMAIL OFFICE@HENTZA.RO</small>		Titlu proiect:	AMENAJARE BENZI DEDICATE TRANSPORTULUI PUBLIC IN MUNICIPIUL BRASOV SI TROTUARE ADIACENTE
Sef Proiect	Ing. A. Buta	Scara	Nr. proiect 73 / 2020
Proiectat	Ing. A. Buta	1/100	Faza P.T.
Desenat	Ing. S. Patroi	Data	Nr. plansa PT-85
Verificat		07/2023	
		Titlu plansa:	PROFILE TRANSVERSALE CURENTE

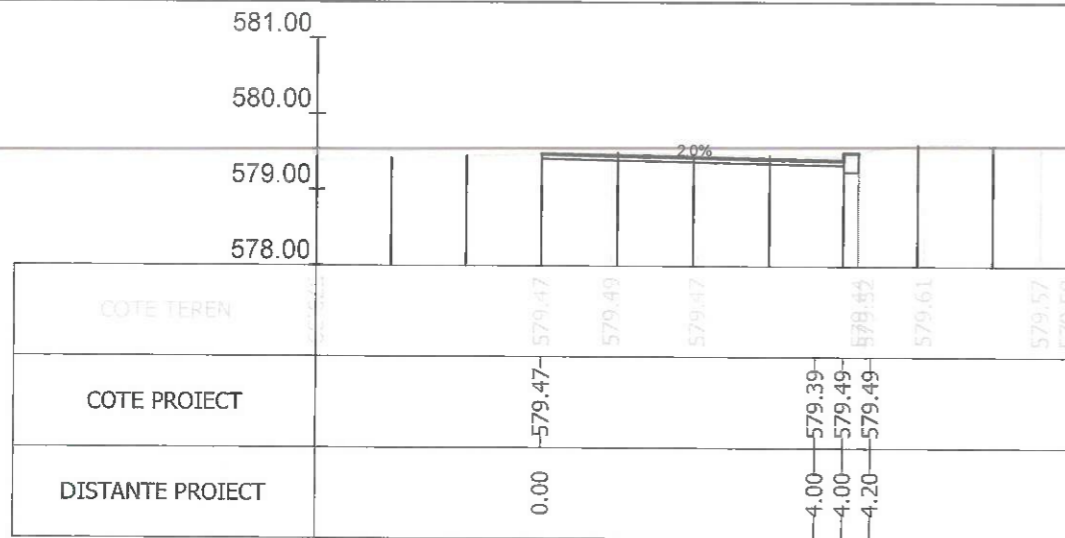

Sectiunea 164 - Km 2+405.719
Ax-Traseul 2

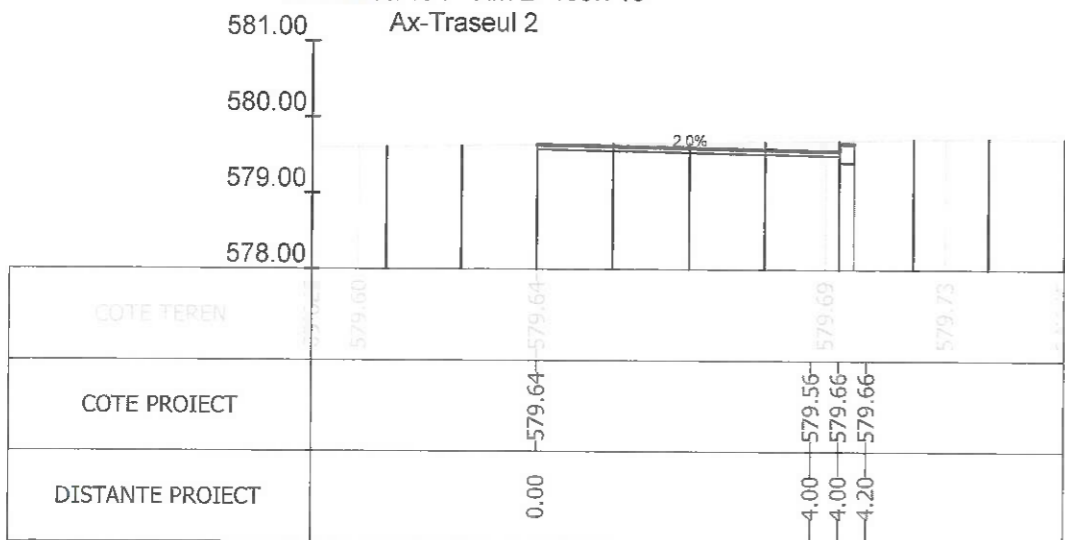

Sectiunea 166 - Km 2+438.777
Ax-Traseul 2

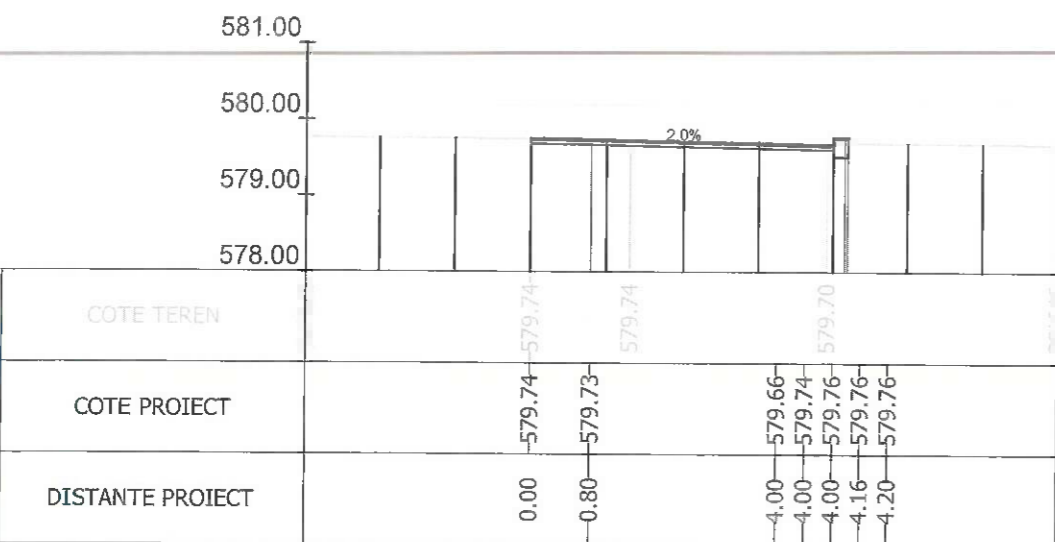

Sectiunea 168 - Km 2+475
Ax-Traseul 2

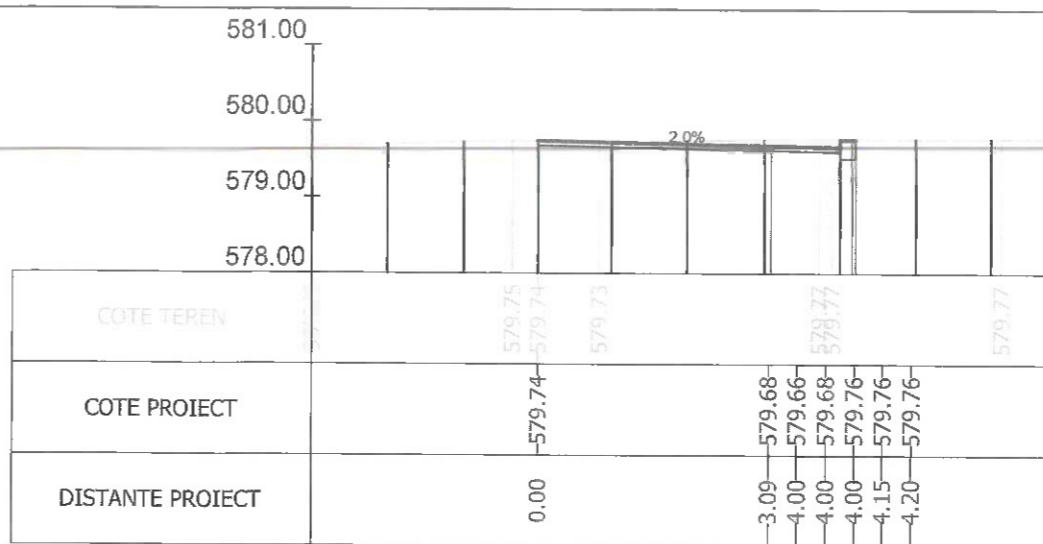

Sectiunea 165 - Km 2+425
Ax-Traseul 2

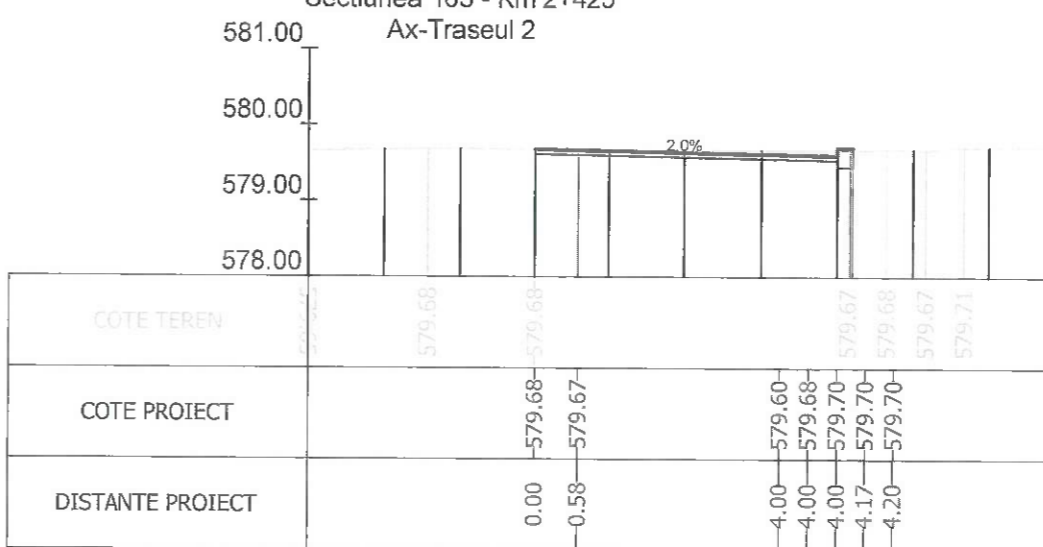

Sectiunea 167 - Km 2+450
Ax-Traseul 2

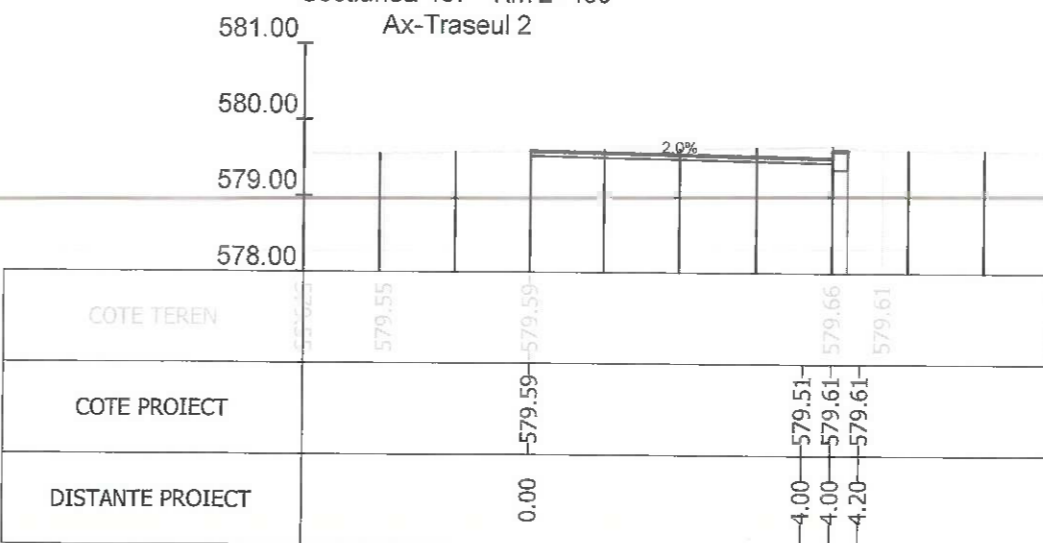

Sectiunea 169 - Km 2+500
Ax-Traseul 2

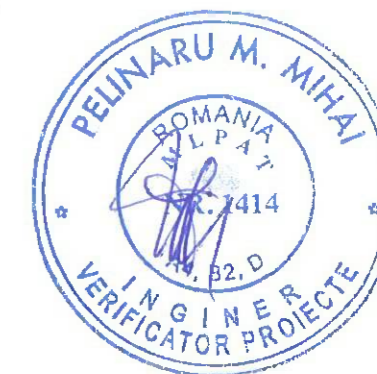

Index	A		Rev. 5
			Beneficiar: MUNICIPIUL BRASOV Bulevardul Eroilor 8, Brasov 500007
Sef Proiect	Ing. A. Buta	Scara 1/100	Nr. proiect 73 / 2020
Proiectat	Ing. A. Buta		Faza P.T.
Desenat	Ing. S. Patroi	Data 07/2023	Nr. plansa PT-86
Verificat			
Titlu proiect: AMENAJARE BENZI DEDICATE TRANSPORTULUI PUBLIC IN MUNICIPIUL BRASOV SI TROTUARE ADIACENTE			
Titlu plansa: PROFILE TRANSVERSALE CURENTE			

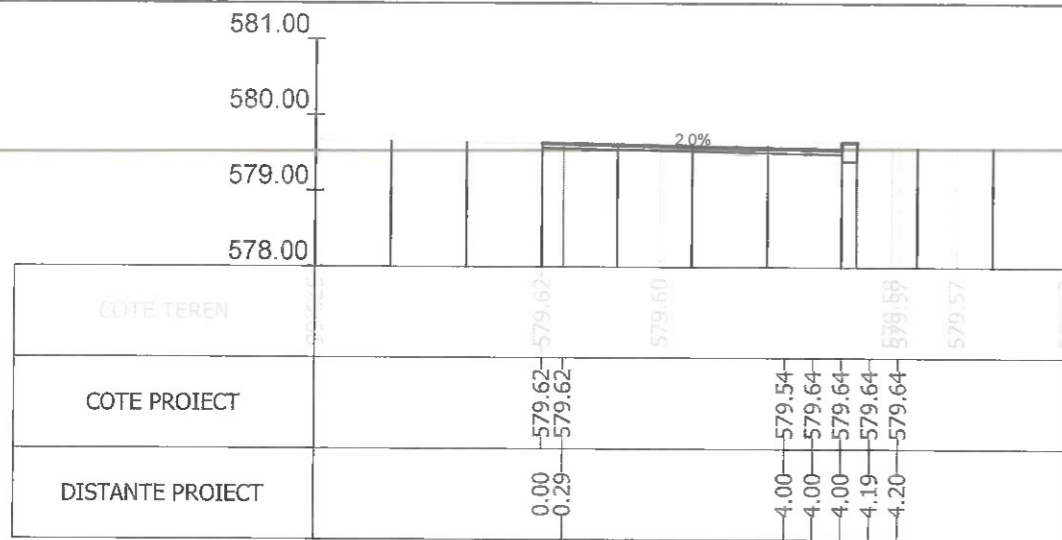

Sectiunea 170 - Km 2+525
Ax-Traseul 2

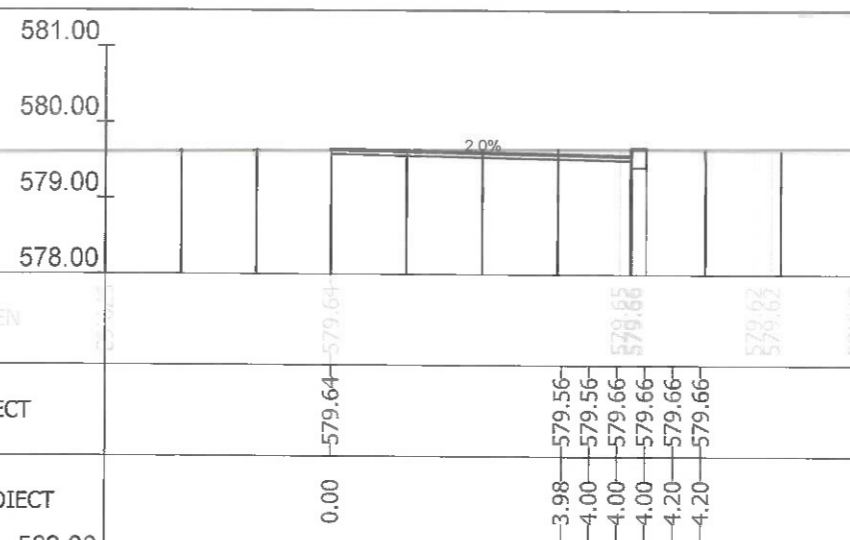
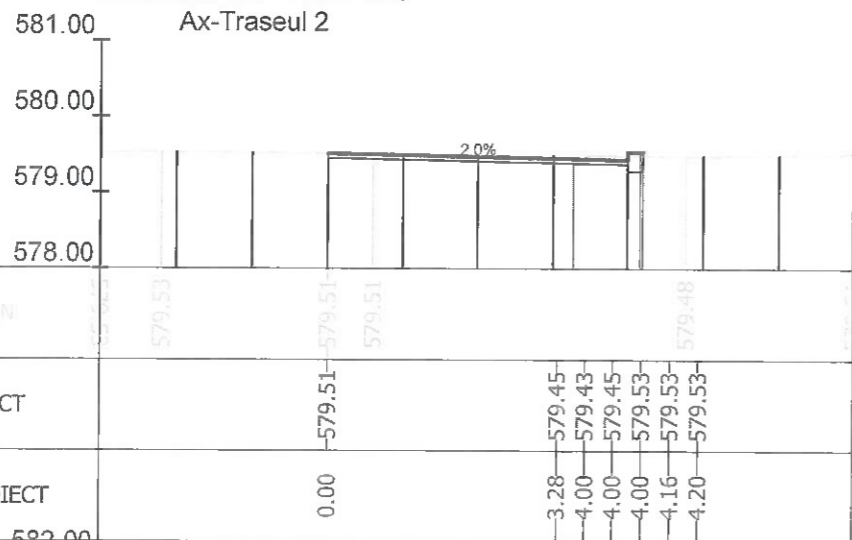

Sectiunea 171 - Km 2+530.744
Ax-Traseul 2

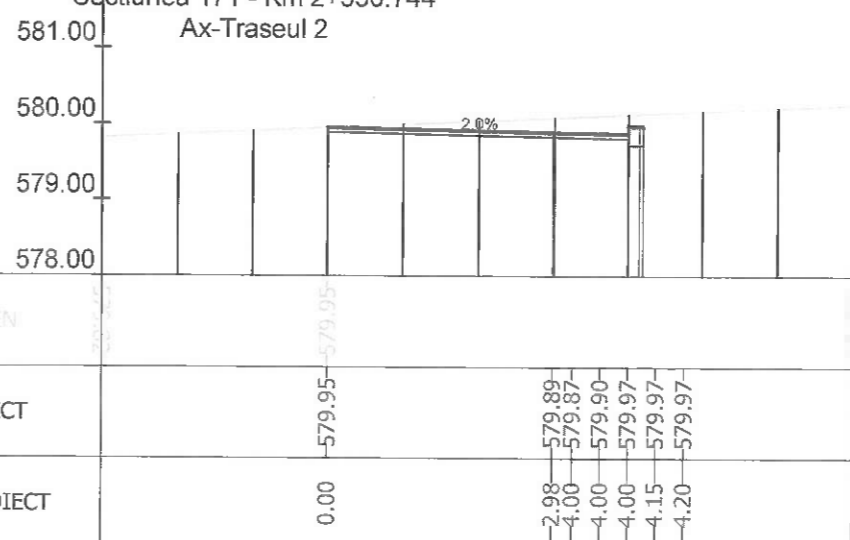

Sectiunea 172 - Km 2+550
Ax-Traseul 2

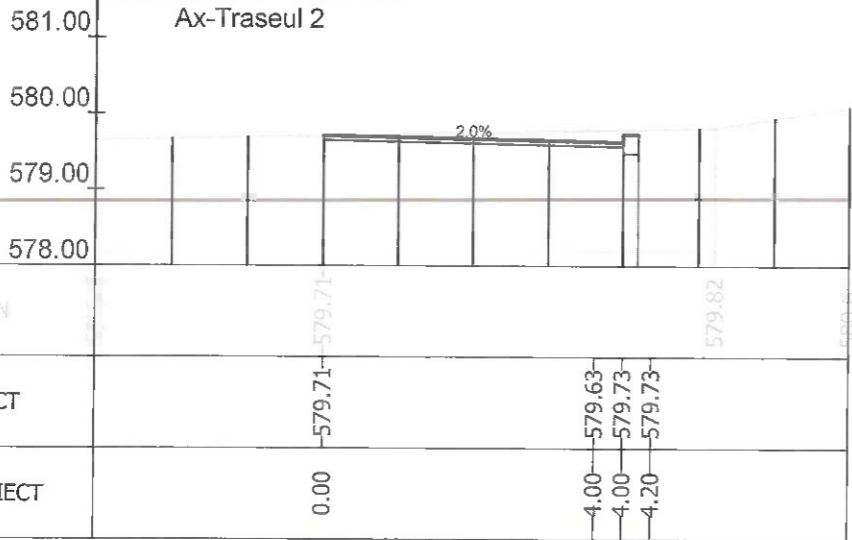

Sectiunea 173 - Km 2+575
Ax-Traseul 2

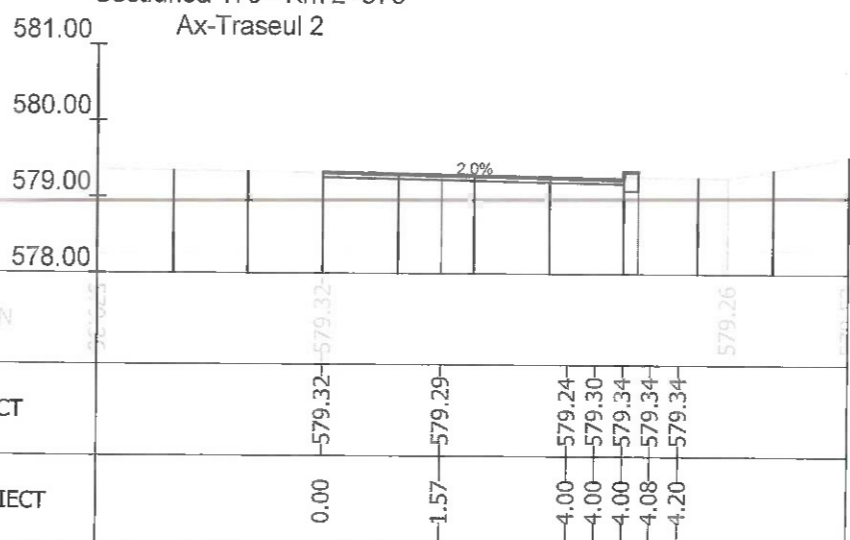

Sectiunea 174 - Km 2+600
Ax-Traseul 2



Index	Data		Rev. 5
A	Ax-Traseul 2		
			Beneficiar:
			MUNICIPIUL BRASOV Bulevardul Eroilor 8, Brasov 500007
			Nr. proiect 73 / 2020
			Titlu proiect:
			AMENAJARE BENZI DEDICATE TRANSPORTULUI PUBLIC IN MUNICIPIUL BRASOV SI TROTUARE ADIACENTE
			Faza P.T.
			Titlu plansa:
			PROFILE TRANSVERSALE CURENTE
			Nr. plansa PT-87
Sef Proiect	Ing. A. Buta	Scara 1/100	
Proiectat	Ing. A. Buta	Data	
Desenat	Ing. S. Patroi	07/2023	
Verificat			

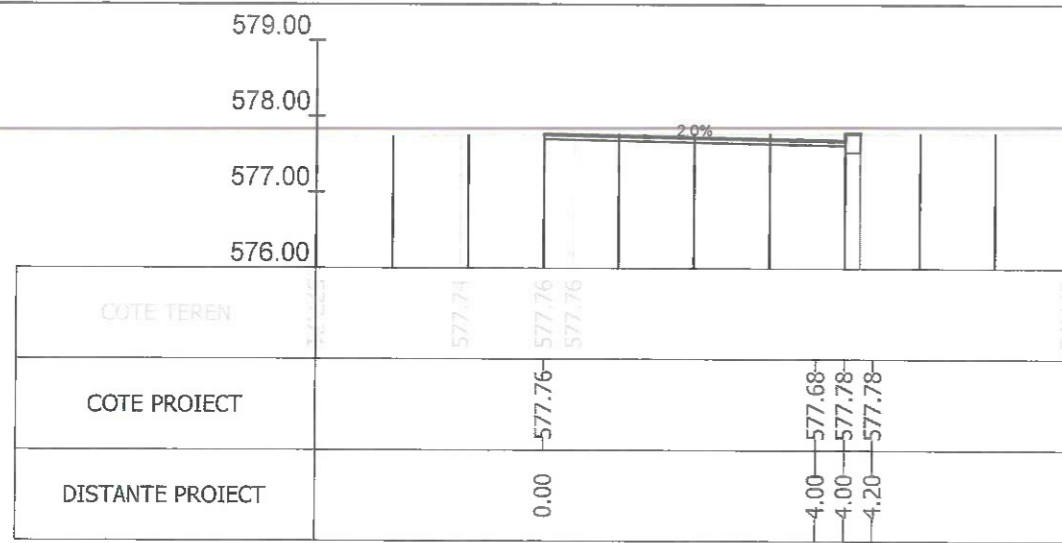

Sectiunea 182 - Km 2+748.133

Ax-Traseul 2

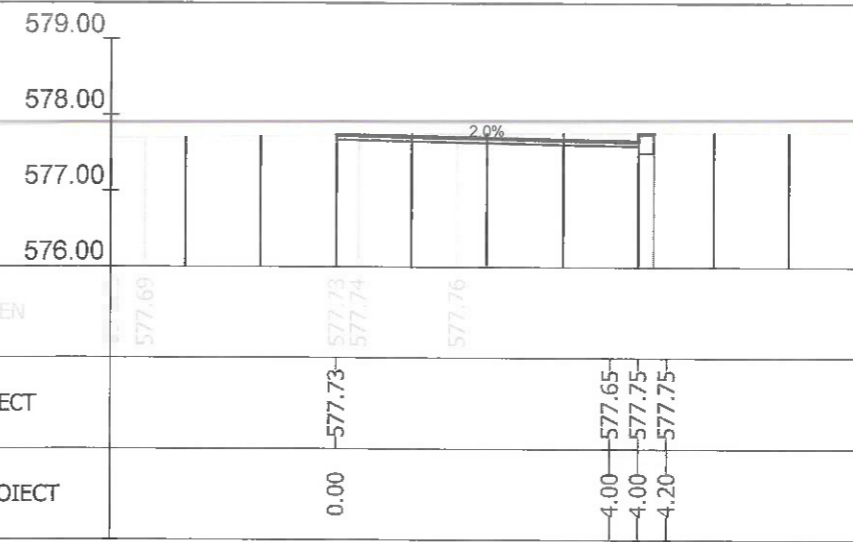
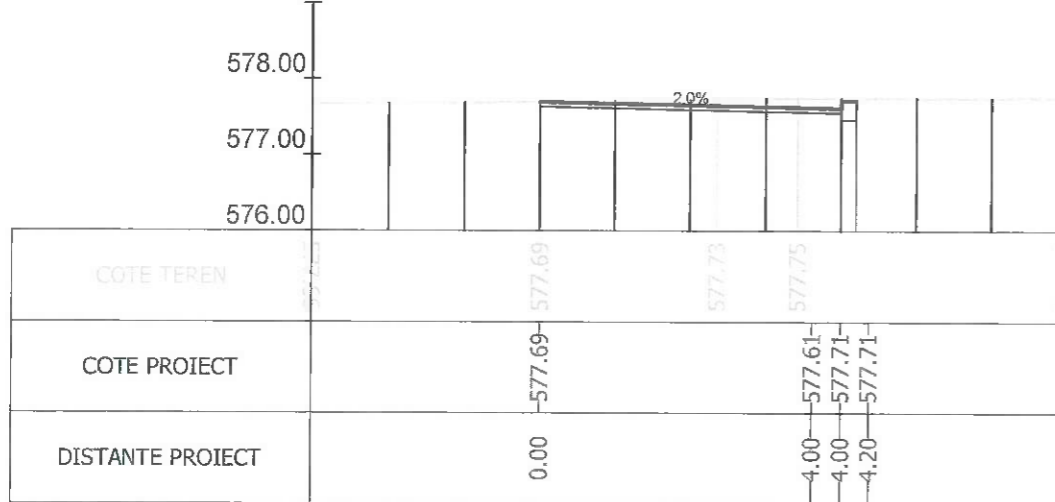

Sectiunea 183 - Km 2+750

Ax-Traseul 2

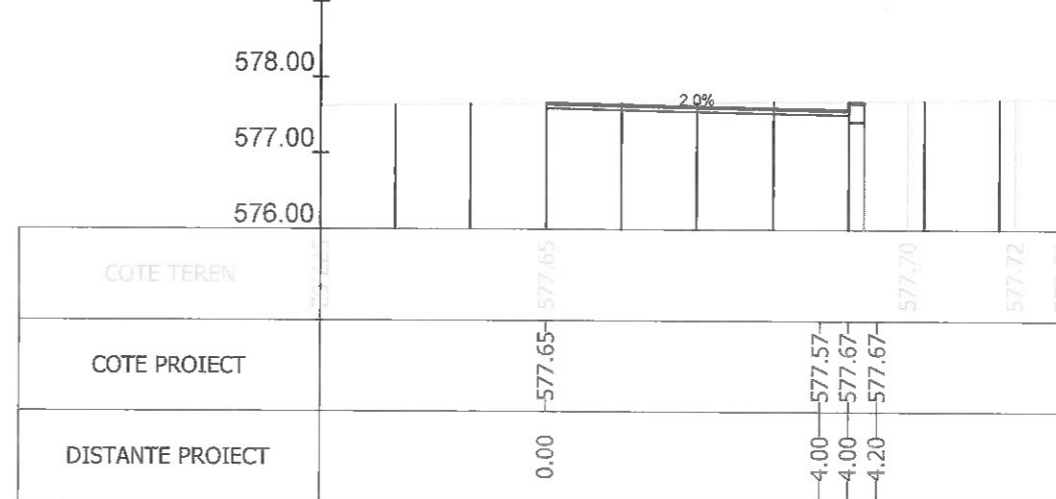

Sectiunea 184 - Km 2+752.645

Ax-Traseul 2

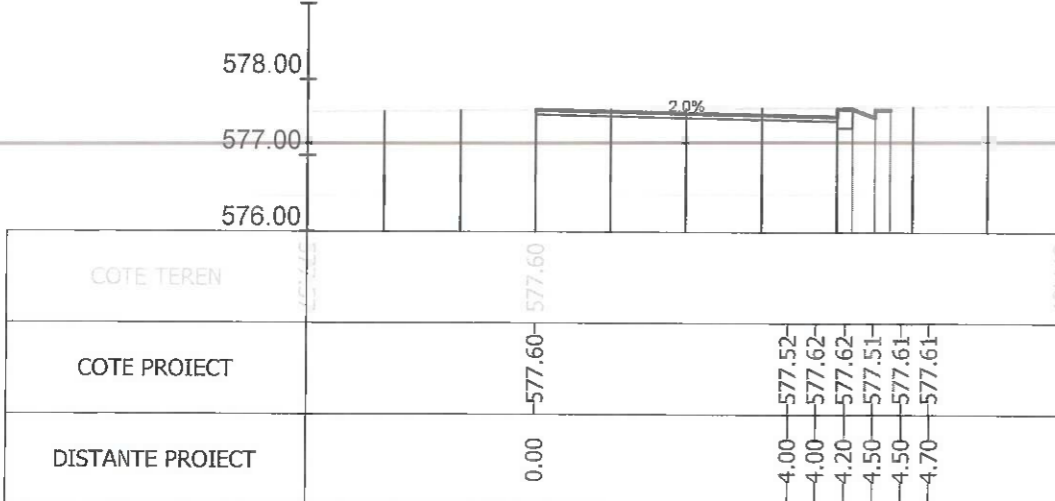

Sectiunea 185 - Km 2+757.157

Ax-Traseul 2

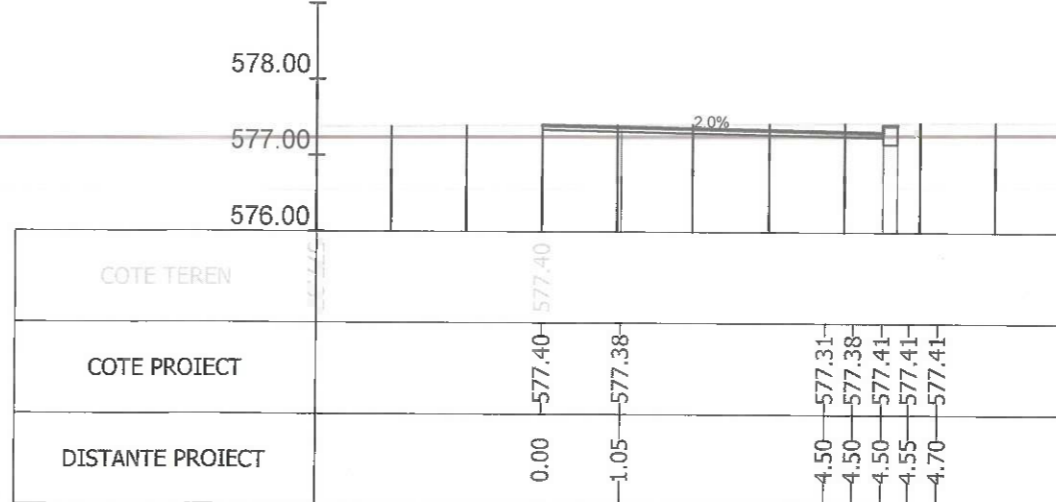

Sectiunea 186 - Km 2+762.659

Ax-Traseul 2

Sectiunea 187 - Km 2+775

Index	Data	Rev. 5
A		
		Beneficiar: MUNICIPIUL BRASOV Bulevardul Eroilor 8, Brasov 500007
Sef Proiect: Ing. A. Buta Proiectat: Ing. A. Buta Desenat: Ing. S. Patroi Verificat:		Nr. proiect: 73 / 2020 Faza: P.T. Nr. plansa: PT-89
Scara: 1/100 Data: 07/2023		Titlu proiect: AMENAJARE BENZI DEDICATE TRANSPORTULUI PUBLIC IN MUNICIPIUL BRASOV SI TROTUARE ADIACENTE Titlu plansa: PROFILE TRANSVERSALE CURENTE



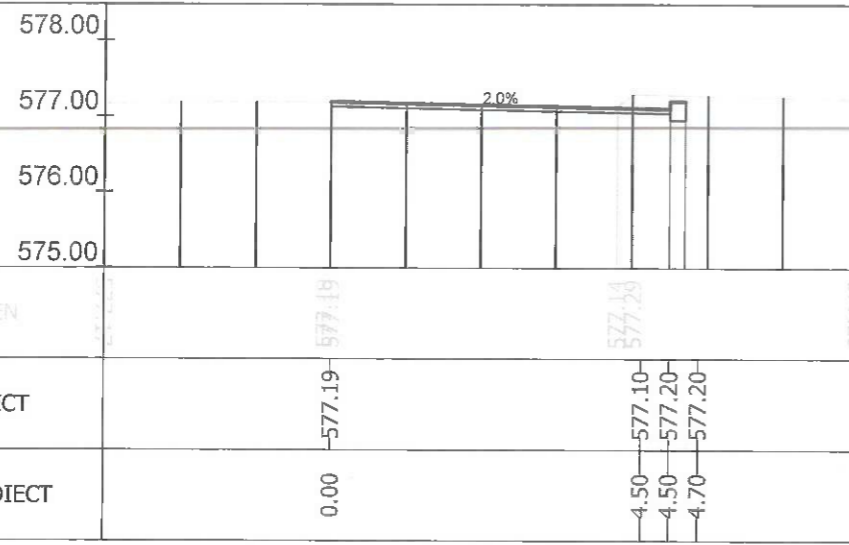

Sectiunea 188 - Km 2+800

Ax-Traseul 2

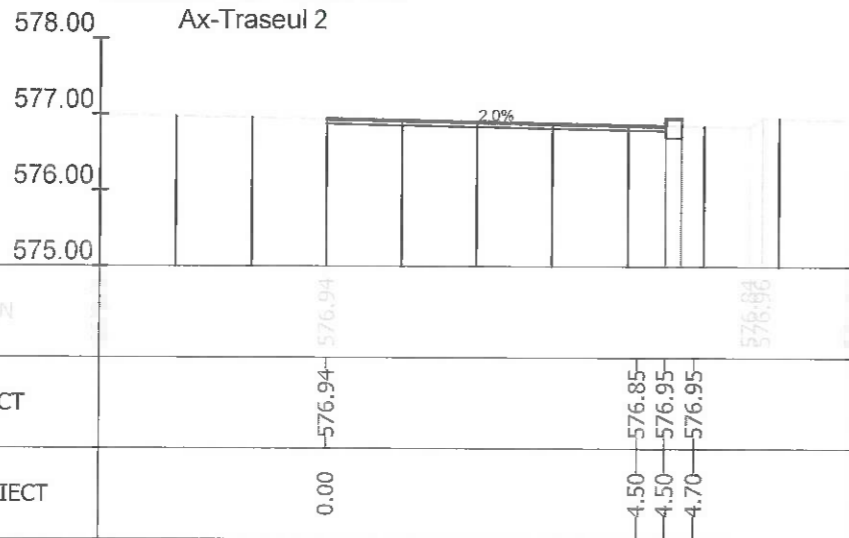

Sectiunea 190 - Km 2+804.233

Ax-Traseul 2

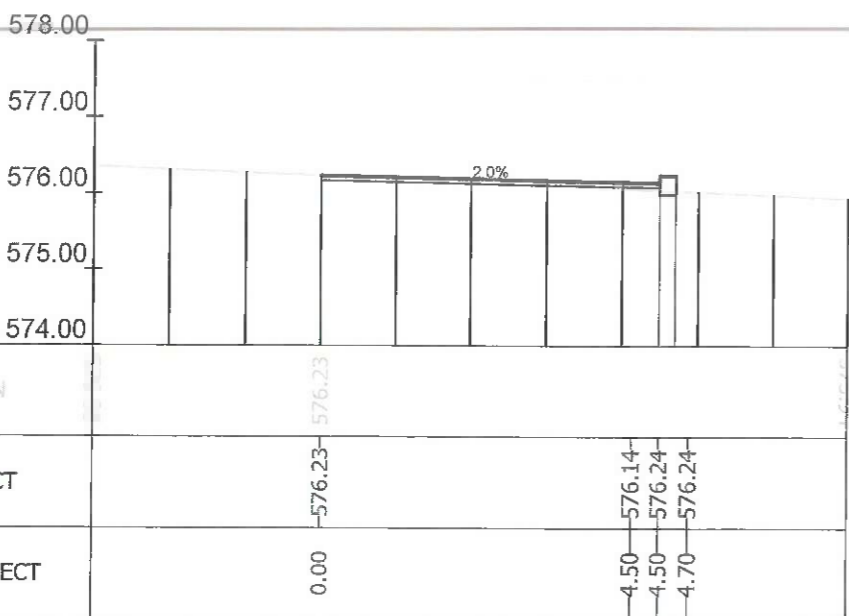

Sectiunea 192 - Km 2+821.758

Ax-Traseul 2

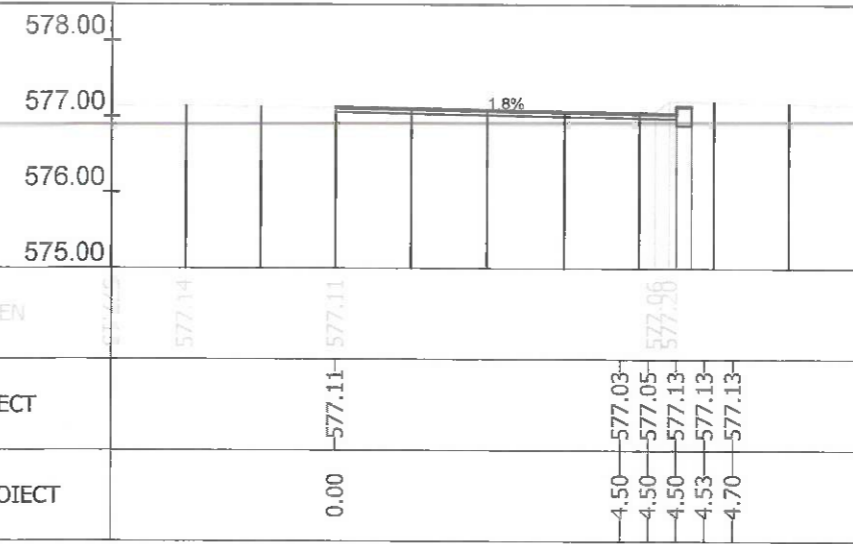

Sectiunea 189 - Km 2+801.230

Ax-Traseul 2

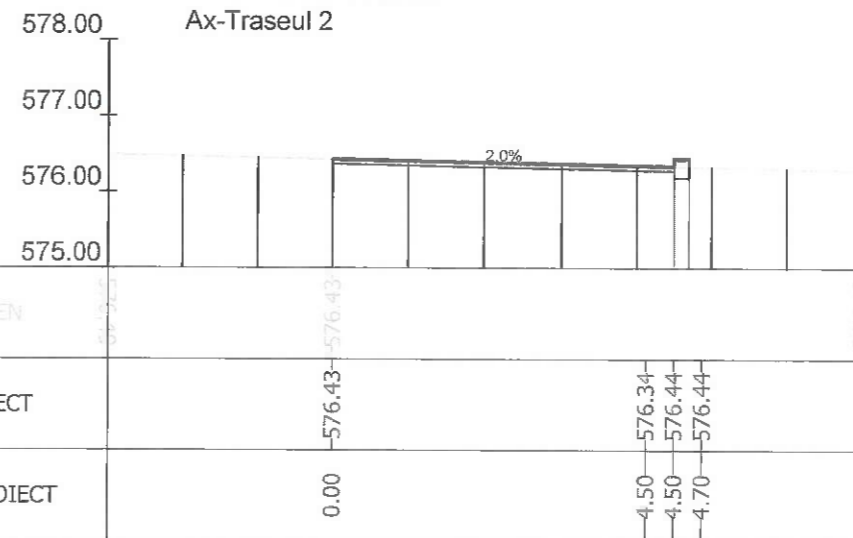

Sectiunea 191 - Km 2+812.996

Ax-Traseul 2

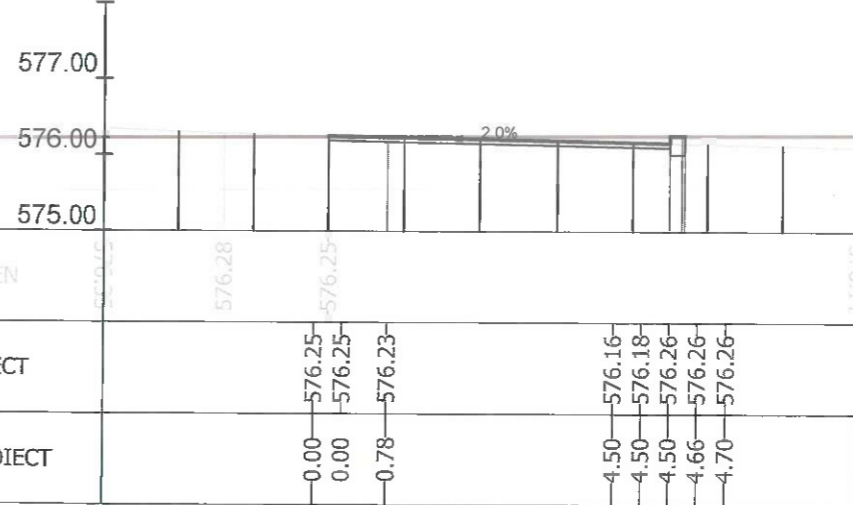

Sectiunea 193 - Km 2+825

Ax-Traseul 2

Index	A								Rev. 5
Sef Proiect		Ing. A. Buta		Scara		Beneficiar:			
Proiectat		Ing. A. Buta		1/100		MUNICIPIUL BRASOV			
Desenat		Ing. S. Patroi		Data		Bulevardul Eroilor 8, Brasov 500007			
Verificat				07/2023		Nr. proiect			
						73 / 2020			
						Titlu proiect:			
						AMENAJARE BENZI DEDICATE			
						TRANSPORTULUI PUBLIC IN MUNICIPIUL			
						BRASOV SI TROTUARE ADIACENTE			
						Faza			
						P.T.			
						Titlu plansa:			
						PROFILE TRANSVERSALE			
						CURENTE			
						Nr. plansa			
						PT-90			



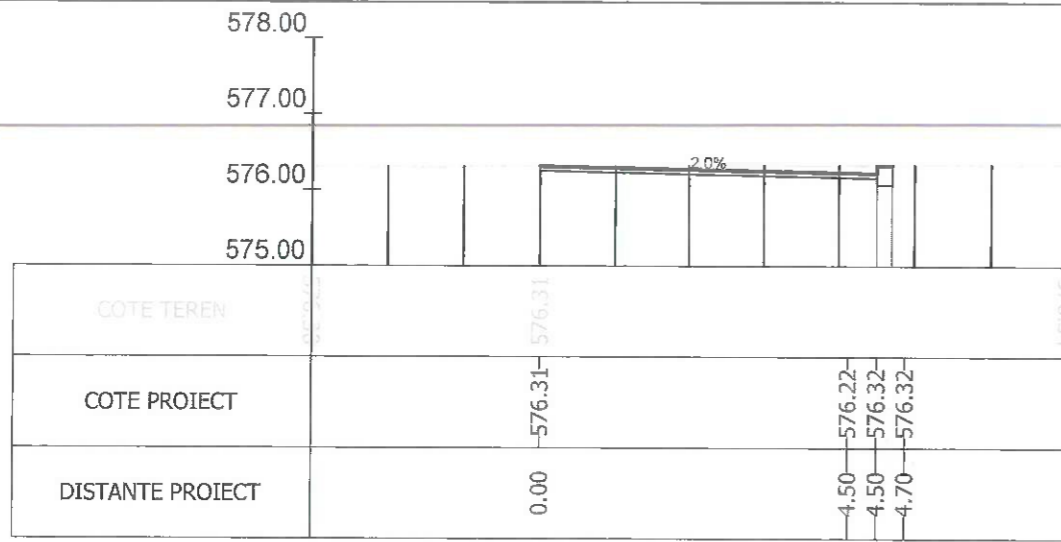

Sectiunea 194 - Km 2+850
Ax-Traceul 2

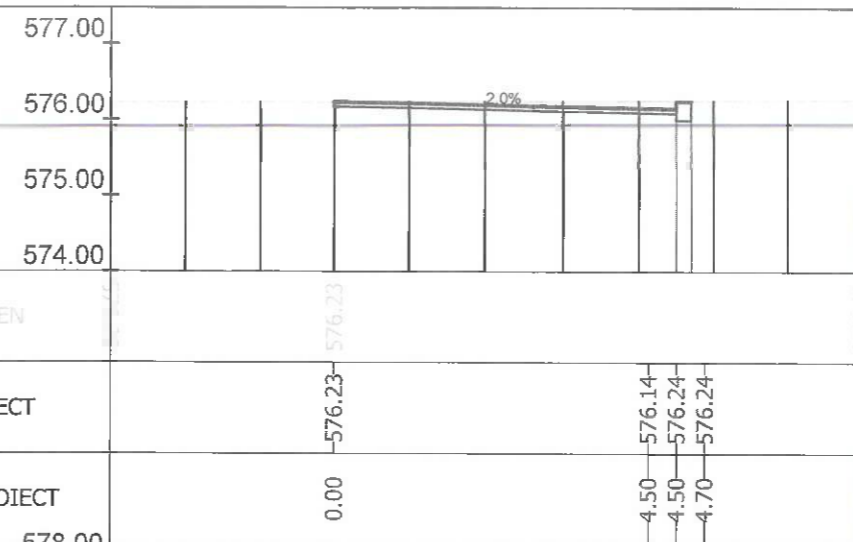
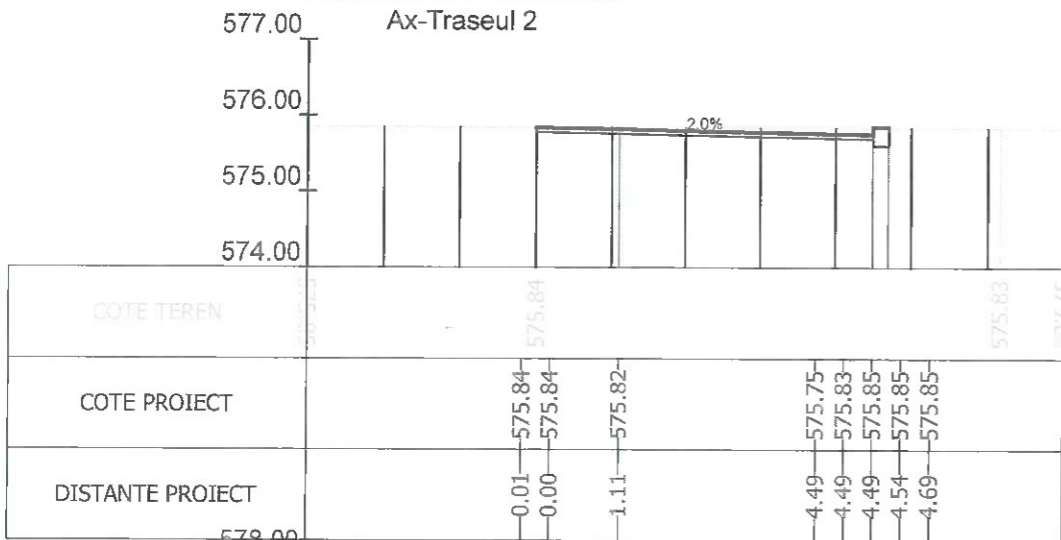

Sectiunea 195 - Km 2+853.951
Ax-Traceul 2

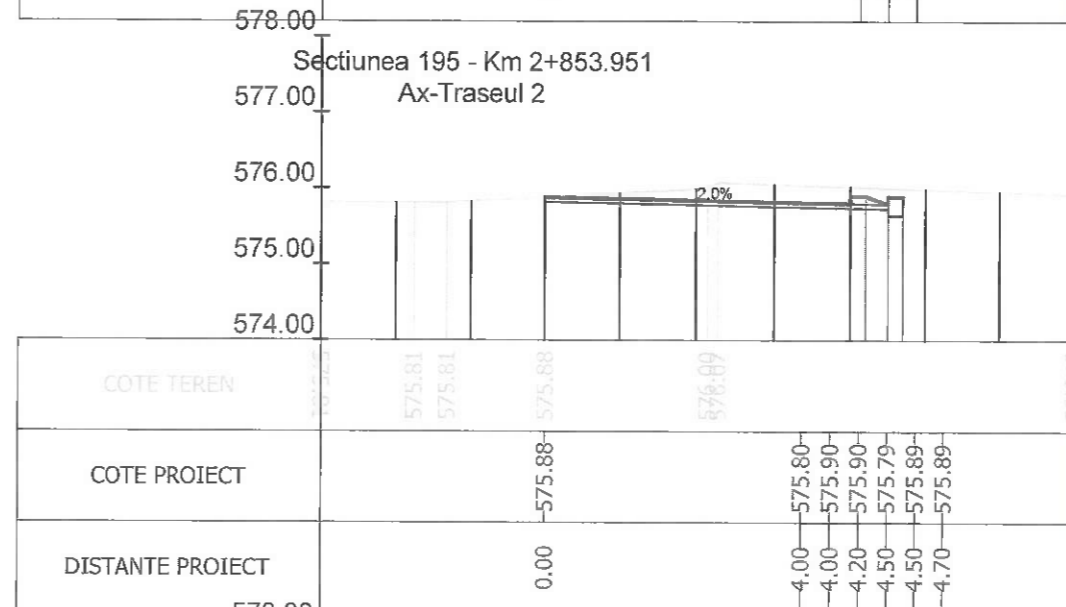

Sectiunea 196 - Km 2+875
Ax-Traceul 2

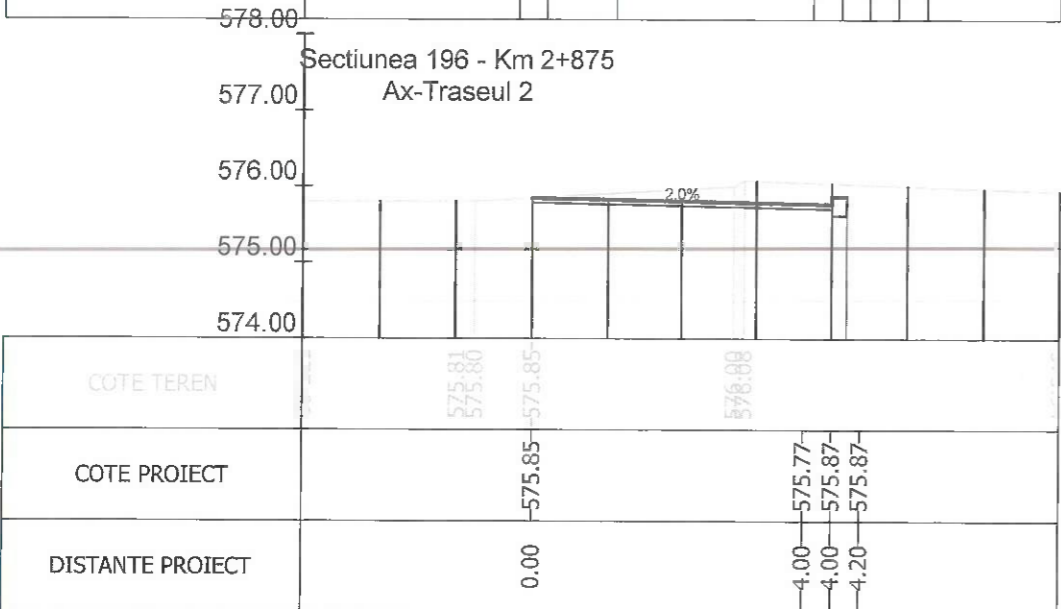

Sectiunea 197 - Km 2+886.143
Ax-Traceul 2

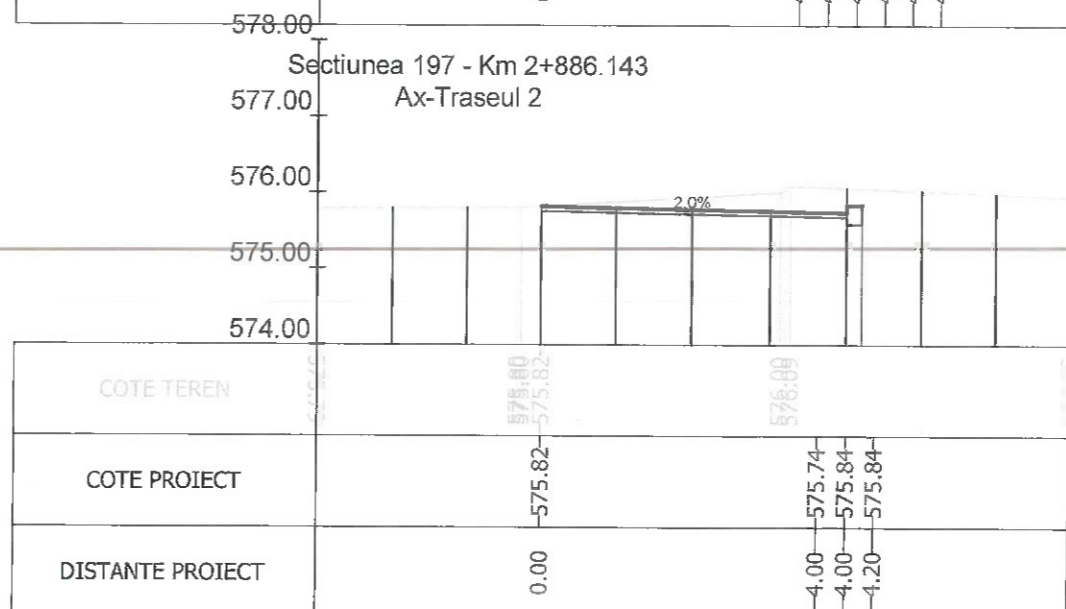

Sectiunea 198 - Km 2+886.765
Ax-Traceul 2

Index	Data	Rev. 5
A		
		Beneficiar: MUNICIPIUL BRASOV Bulevardul Eroilor 8, Brasov 500007
Sef Proiect: Ing. A. Buta Proiectat: Ing. A. Buta Desenat: Ing. S. Patroi Verificat:		Nr. proiect: 73 / 2020 Faza P.T. Nr. plansa: PT-91
Scara: 1/100 Data: 07/2023		Titlu proiect: AMENAJARE BENZI DEDICATE TRANSPORTULUI PUBLIC IN MUNICIPIUL BRASOV SI TROTUARE ADIACENTE Titlu plansa: PROFILE TRANSVERSALE CURENTE



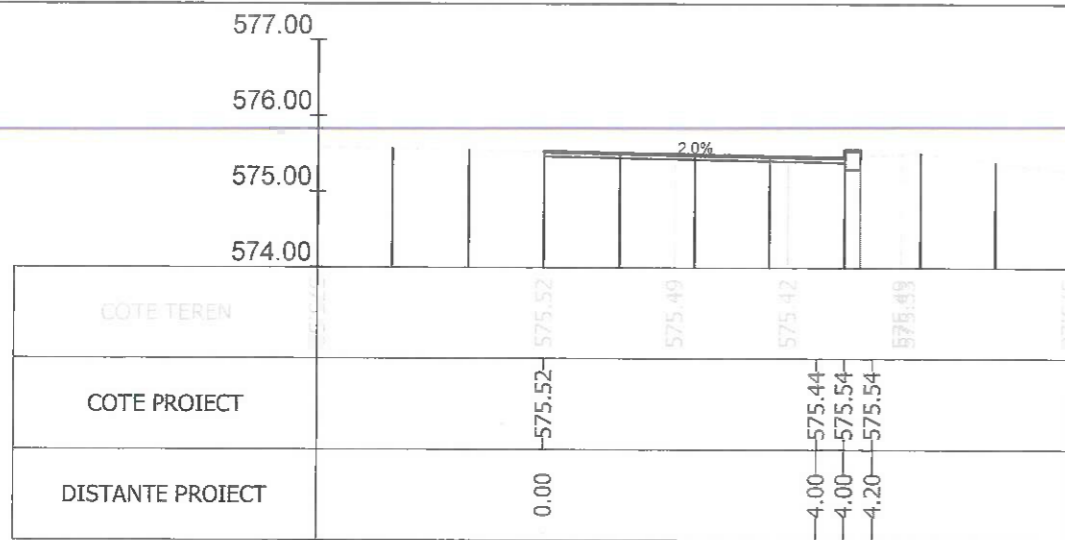

Sectiunea 200 - Km 2+894.819

Ax-Traseul 2

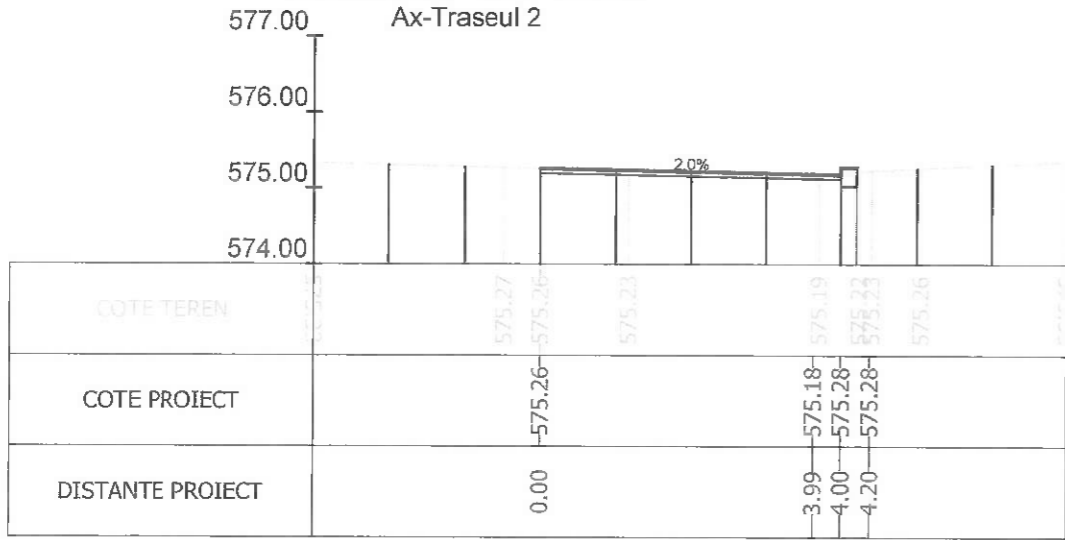

Sectiunea 202 - Km 2+902.252

Ax-Traseul 2

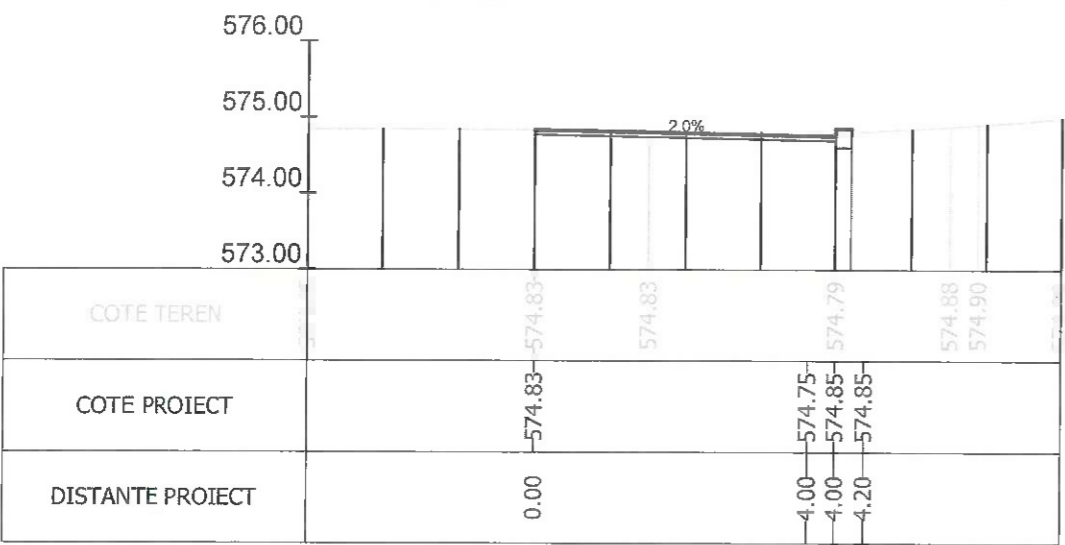

Sectiunea 204 - Km 2+928.965

Ax-Traseul 2

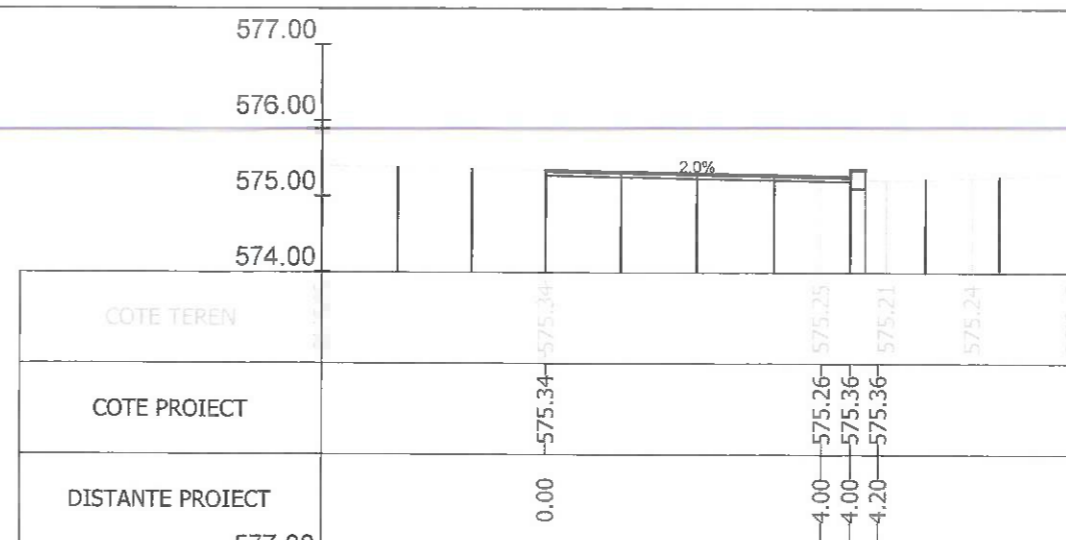

Sectiunea 201 - Km 2+900

Ax-Traseul 2

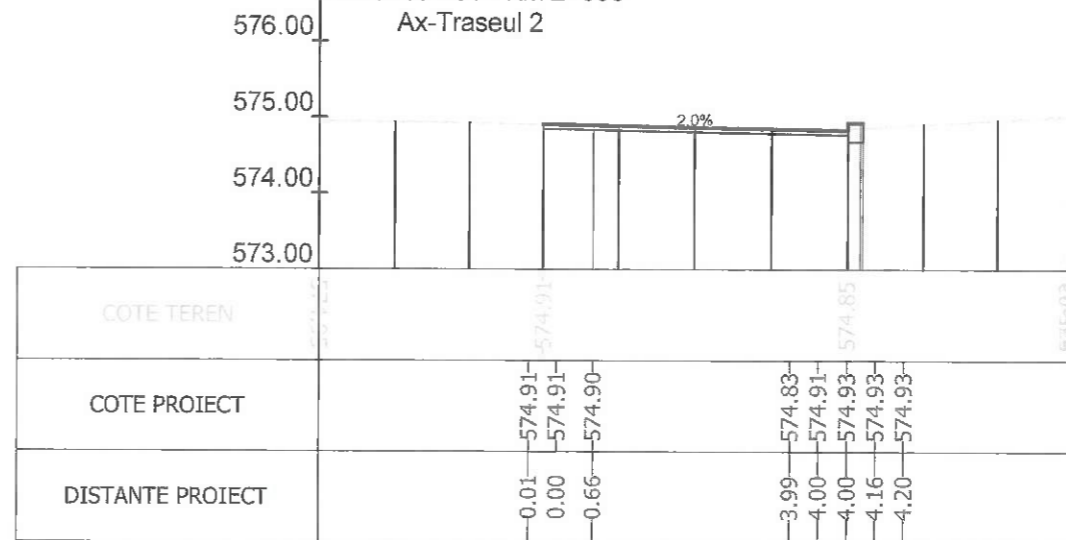

Sectiunea 203 - Km 2+925

Ax-Traseul 2

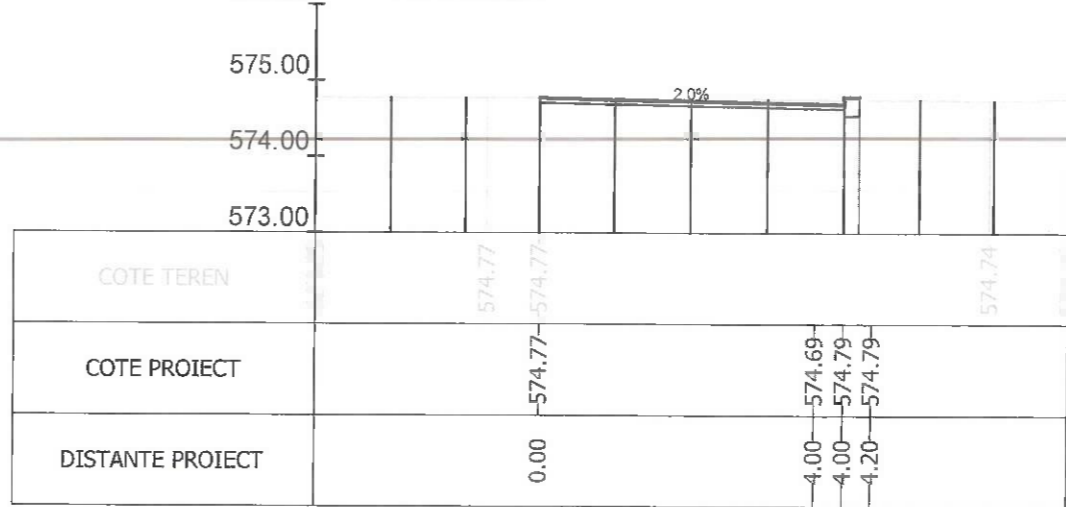

Sectiunea 205 - Km 2+950

Ax-Traseul 2

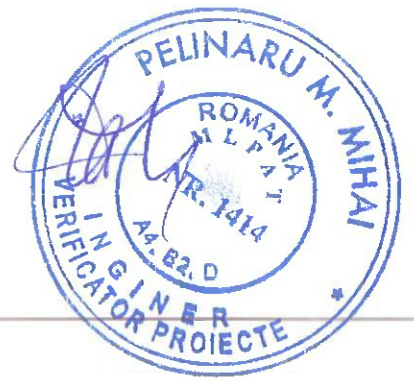

Index	A		Rev. 5
Beneficiar:		MUNICIPIUL BRASOV Bulevardul Eroilor 8, Brasov 500007	Nr. proiect 73 / 2020
Titlu proiect:		AMENAJARE BENZI DEDICATE TRANSPORTULUI PUBLIC IN MUNICIPIUL BRASOV SI TROTUARE ADIACENTE	Faza P.T.
Titlu plansa:		PROFILE TRANSVERSALE CURENTE	Nr. plansa PT-92
Sef Proiect	Ing. A. Buta	Scara	
Proiectat	Ing. A. Buta	1/100	
Desenat	Ing. S. Patroi	Data	
Verificat		07/2023	

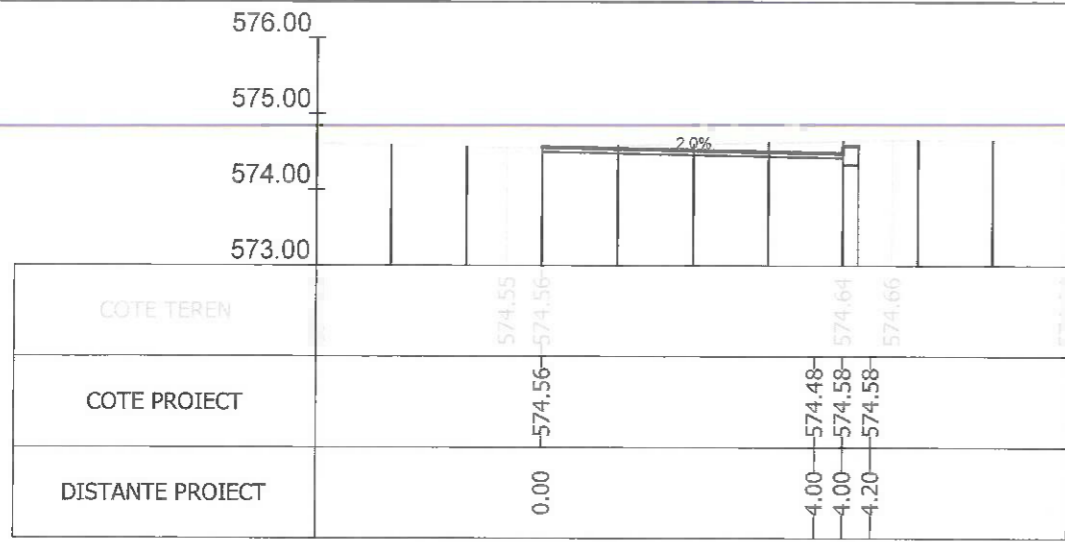

Sectiunea 206 - Km 2+955.677

Ax-Traseul 2

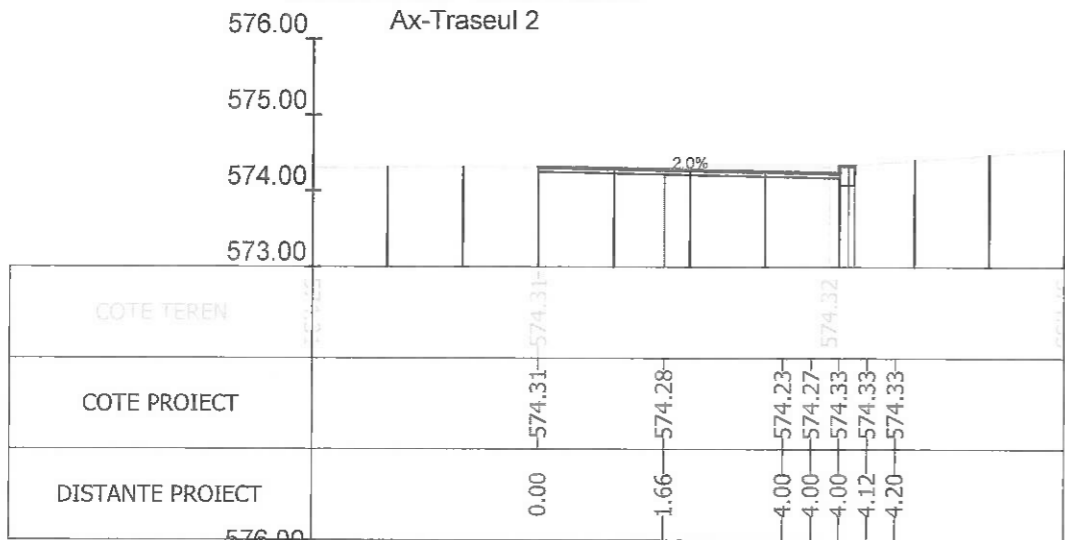

Sectiunea 207 - Km 2+970.180

Ax-Traseul 2

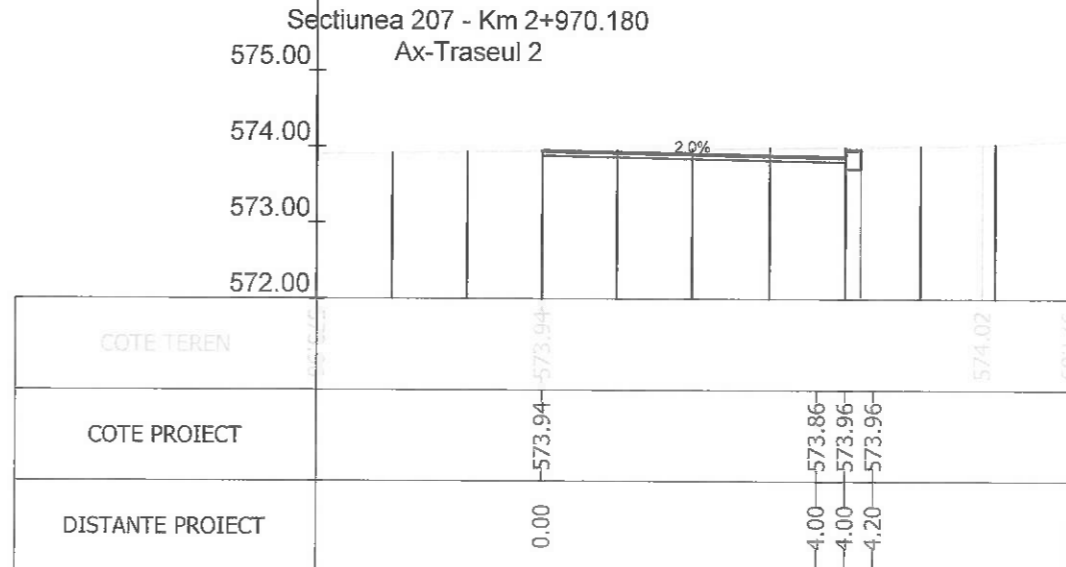

Sectiunea 209 - Km 3+000

Ax-Traseul 2

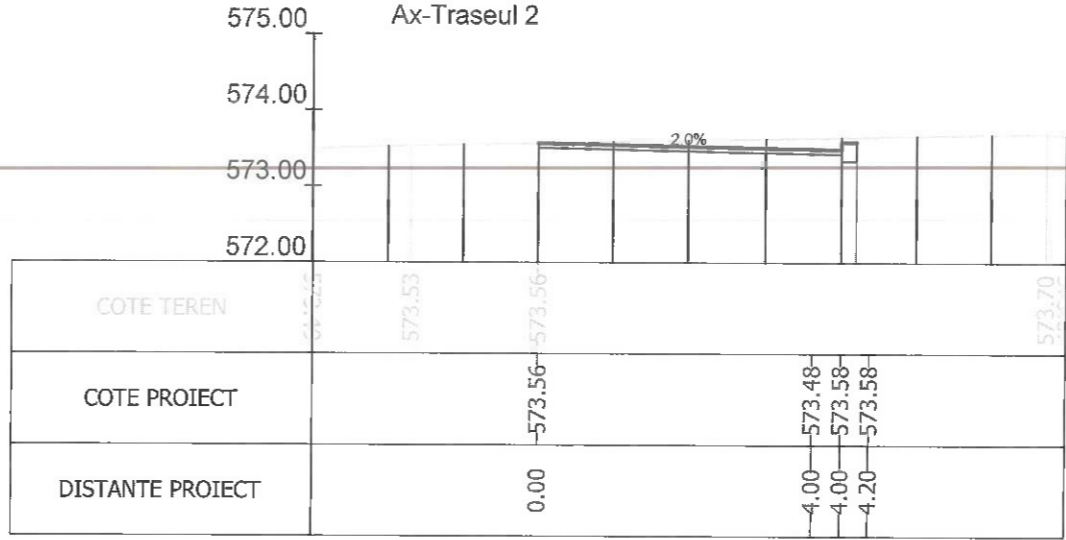

Sectiunea 210 - Km 3+025

Ax-Traseul 2

Sectiunea 211 - Km 3+043.647

Index	Data	Observatii	Rev. 5
A			
		Beneficiar:	MUNICIPIUL BRASOV Bulevardul Eroilor 8, Brasov 500007
Sef Proiect: Ing. A. Buta Proiectat: Ing. A. Buta Desenat: Ing. S. Patroi Verificat:		Titlu proiect:	AMENAJARE BENZI DEDICATE TRANSPORTULUI PUBLIC IN MUNICIPIUL BRASOV SI TROTUARE ADIACENTE
Scara: 1/100 Data: 07/2023		Titlu plansa:	PROFILE TRANSVERSALE CURENTE
		Nr. proiect:	73 / 2020
		Faza:	P.T.
		Nr. plansa:	PT-93



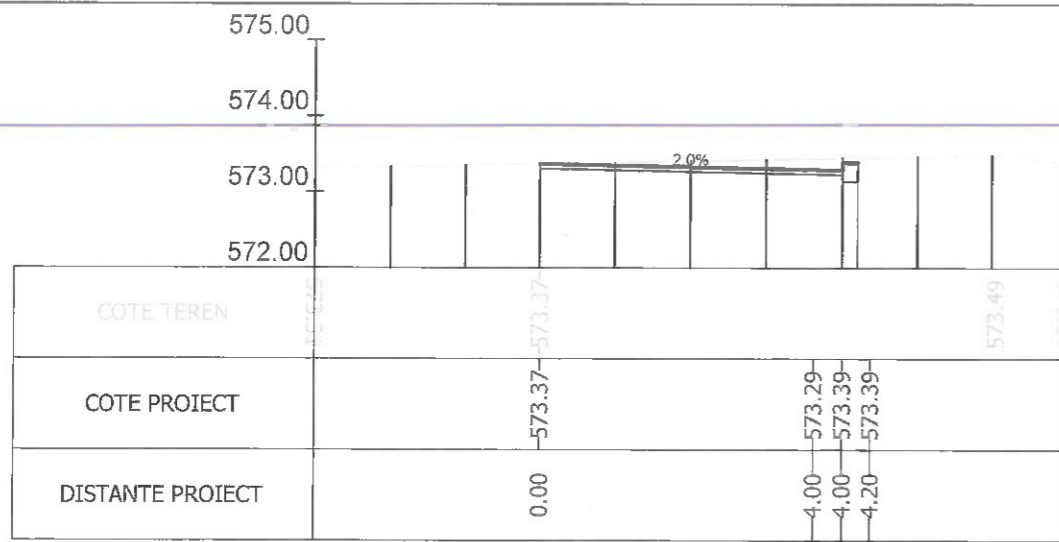

Sectiunea 212 - Km 3+050
Ax-Traseul 2

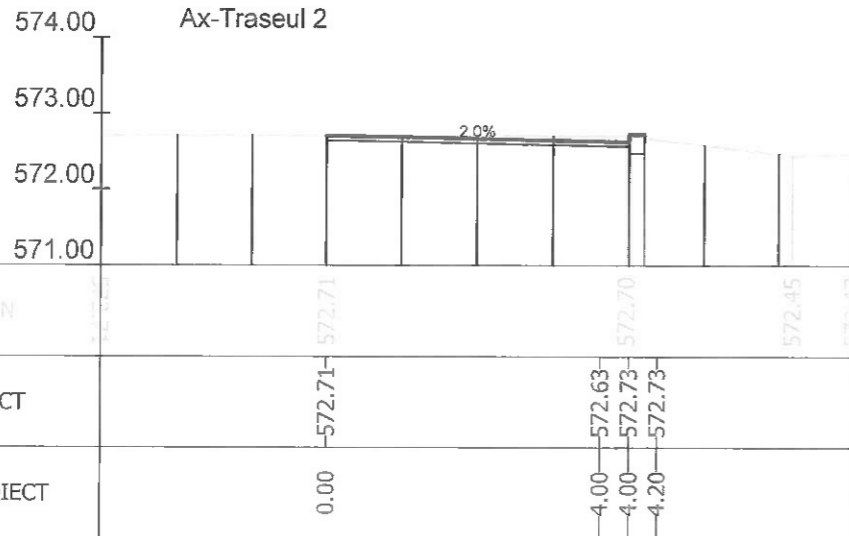

Sectiunea 214 - Km 3+075.790
Ax-Traseul 2

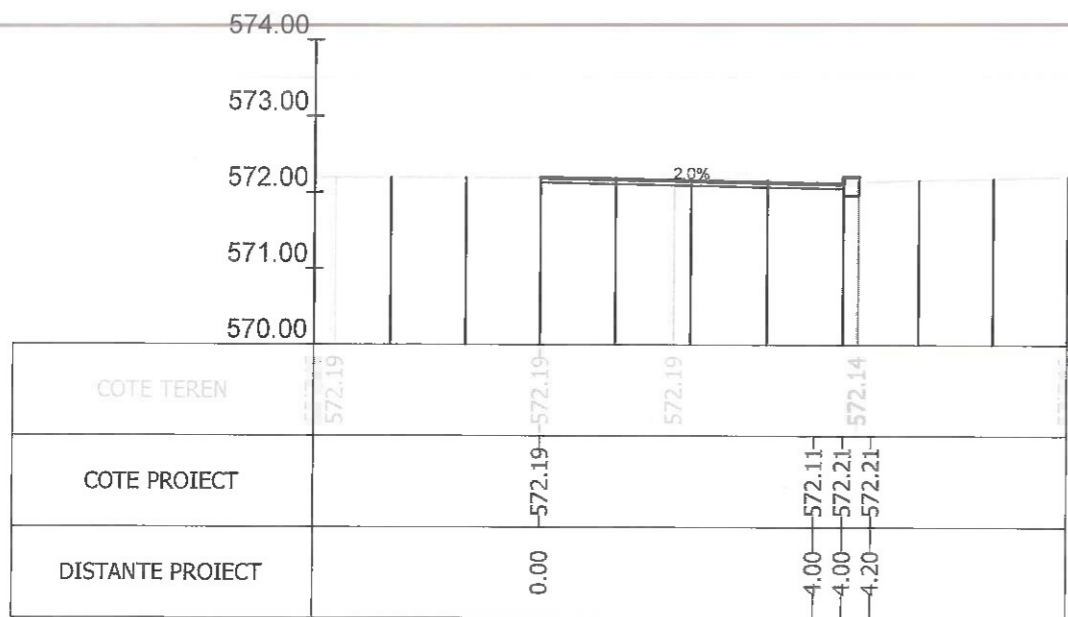

Sectiunea 216 - Km 3+107.934
Ax-Traseul 2

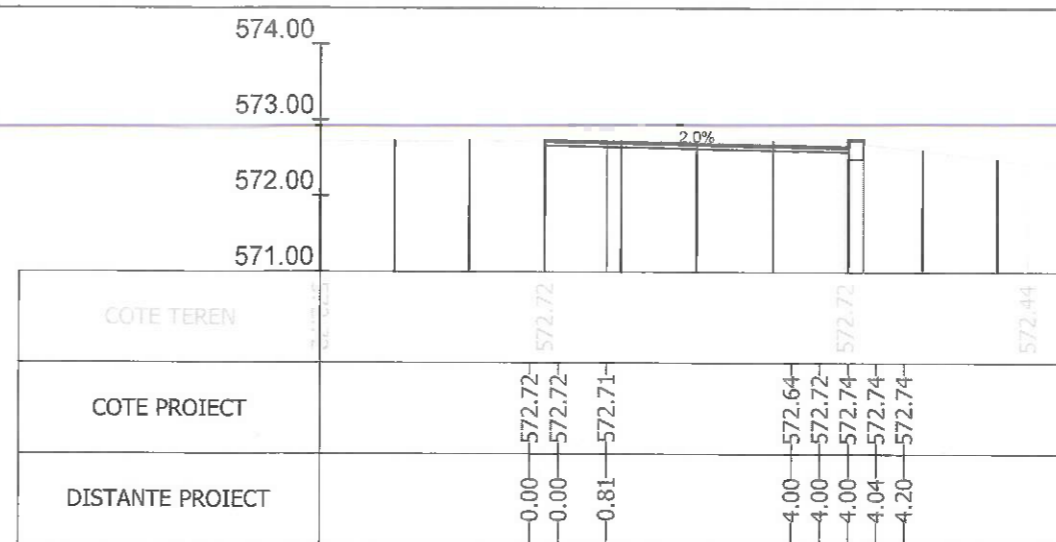

Sectiunea 213 - Km 3+075
Ax-Traseul 2

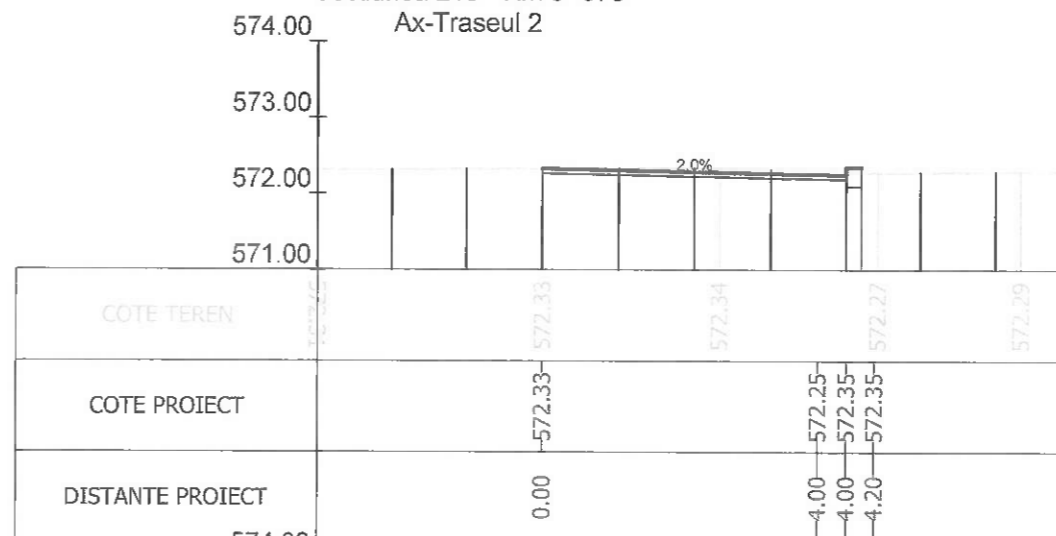

Sectiunea 215 - Km 3+100
Ax-Traseul 2

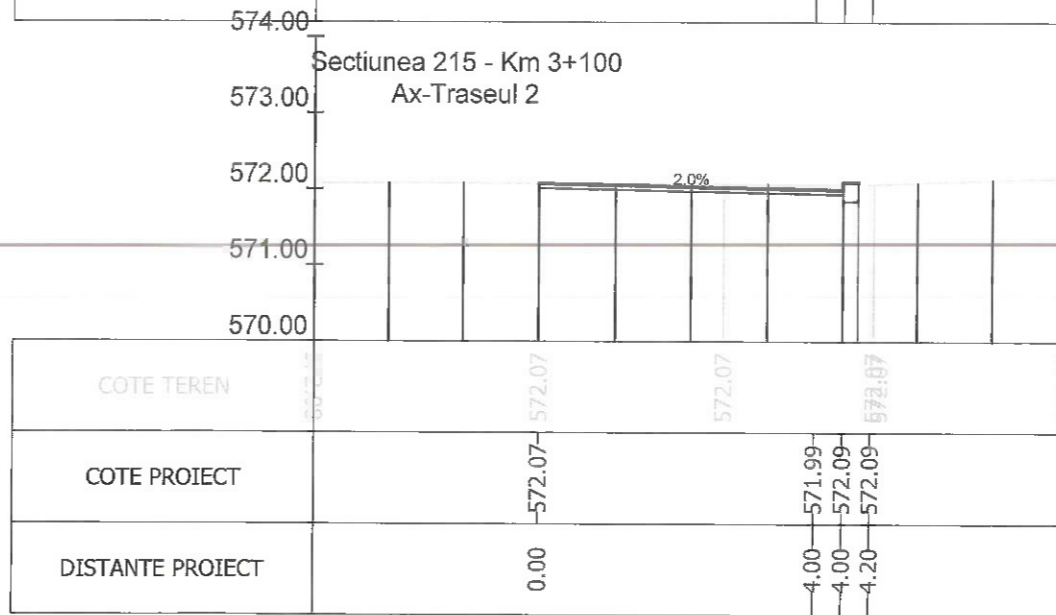

Sectiunea 217 - Km 3+112.847
Ax-Traseul 2

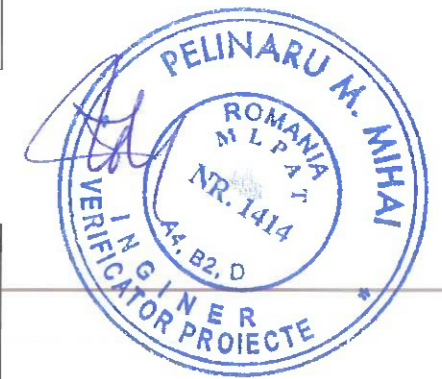

Index	A		Rev. 5
Beneficiar:	MUNICIPIUL BRASOV Bulevardul Eroilor 8, Brasov 500007		Nr. proiect 73 / 2020
Titlu proiect:	AMENAJARE BENZI DEDICATE TRANSPORTULUI PUBLIC IN MUNICIPIUL BRASOV SI TROTUARE ADIACENTE		Faza P.T.
Titlu plansa:	PROFILE TRANSVERSALE CURENTE		Nr. plansa PT-94
Sef Proiect	Ing. A. Buta	Scara	
Proiectat	Ing. A. Buta	1/100	
Desenat	Ing. S. Patroi	Data	
Verificat		07/2023	

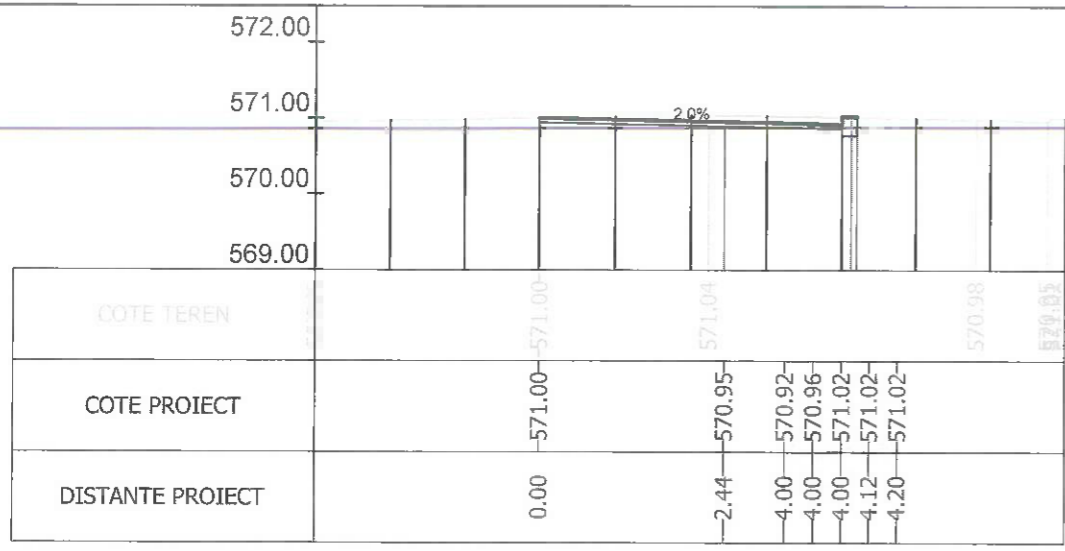

Sectiunea 224 - Km 3+225
Ax-Traseul 2

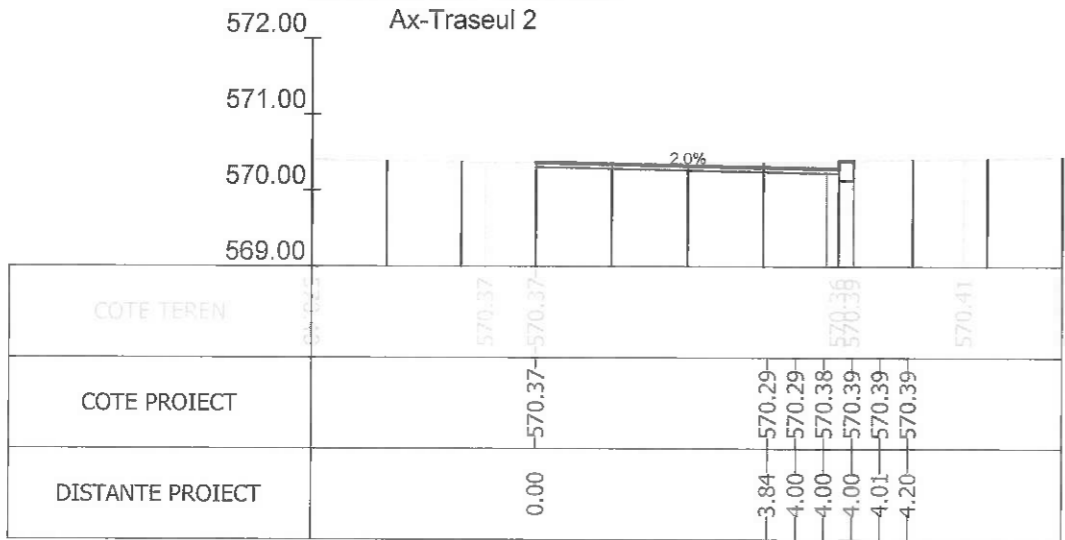

Sectiunea 226 - Km 3+275
Ax-Traseul 2

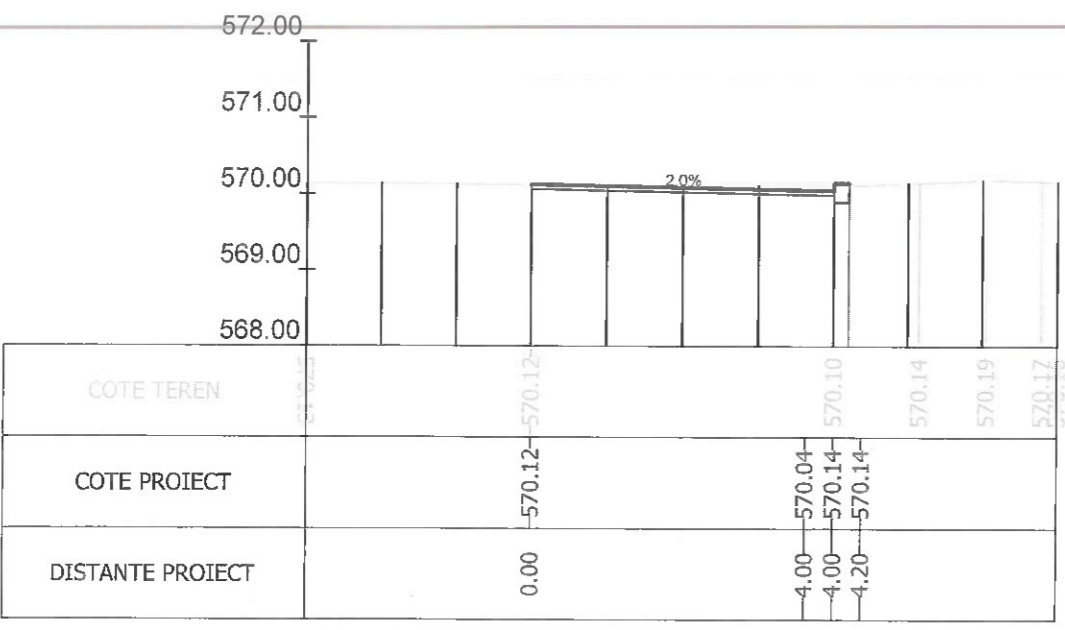

Sectiunea 228 - Km 3+307.281
Ax-Traseul 2

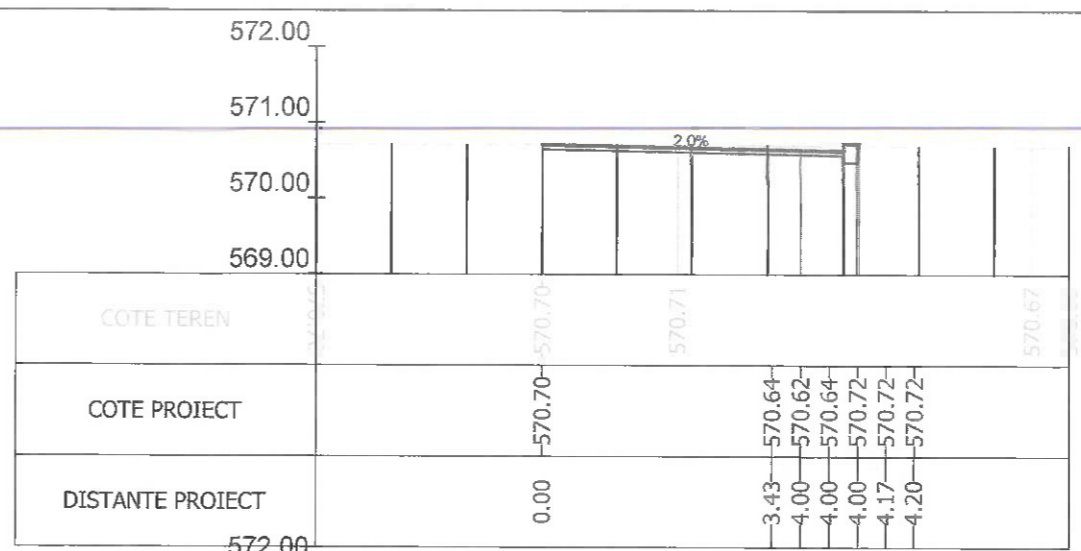

Sectiunea 225 - Km 3+250
Ax-Traseul 2

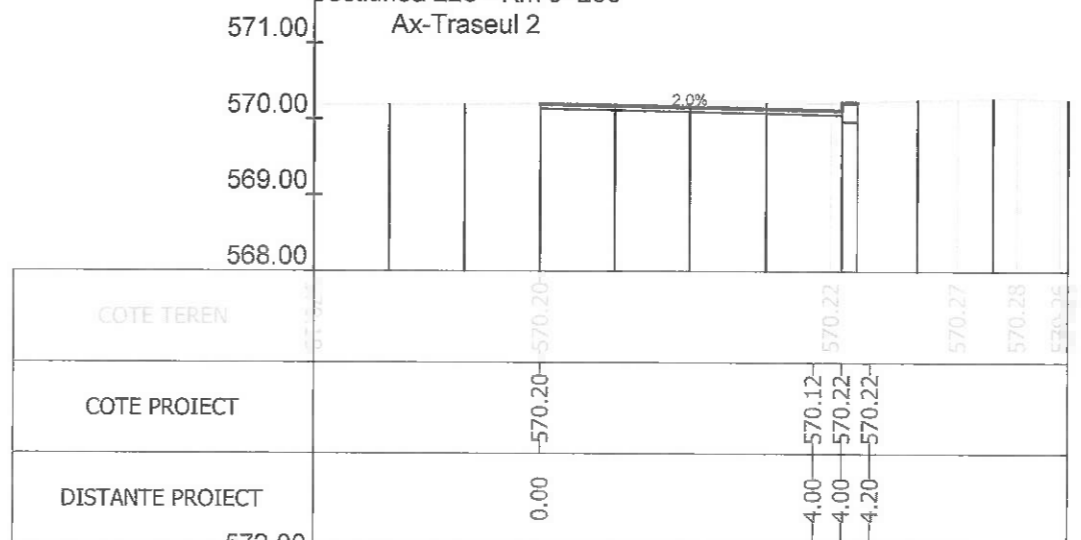

Sectiunea 227 - Km 3+300
Ax-Traseul 2

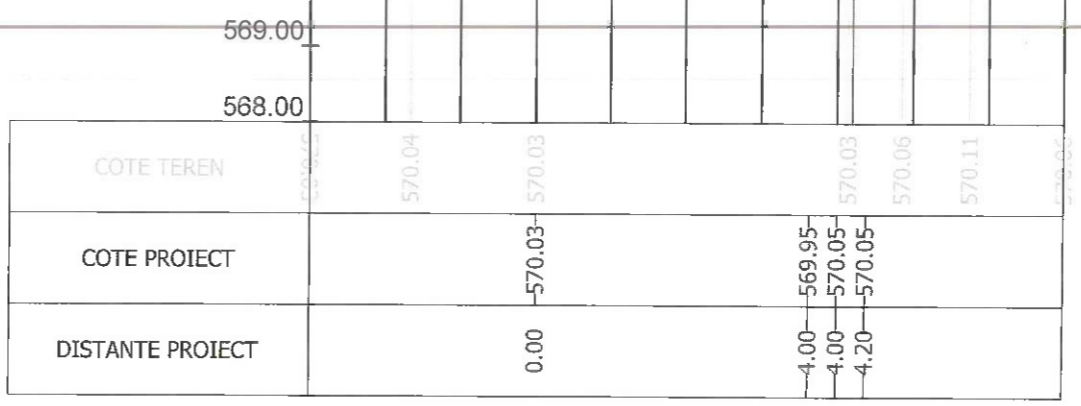

Sectiunea 229 - Km 3+314.598
Ax-Traseul 2

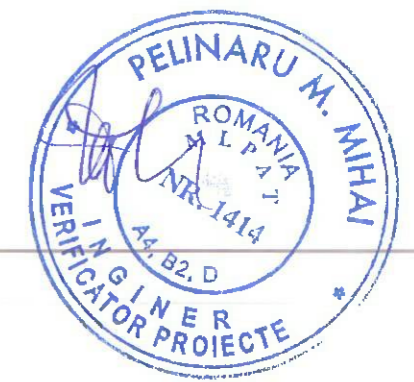

Index	A		Rev. 5
			Beneficiar: MUNICIPIUL BRASOV Bulevardul Eroilor 8, Brasov 500007
Scara 1/100			Nr. proiect 73 / 2020
Titlu proiect: AMENAJARE BENZI DEDICATE TRANSPORTULUI PUBLIC IN MUNICIPIUL BRASOV SI TROTUARE ADIACENTE			Faza P.T.
Titlu plansa: PROFILE TRANSVERSALE CURENTE			Nr. plansa PT-96
Sef Proiect	Ing. A. Buta		Data
Proiectat	Ing. A. Buta		07/2023
Desenat	Ing. S. Patroi		
Verificat			

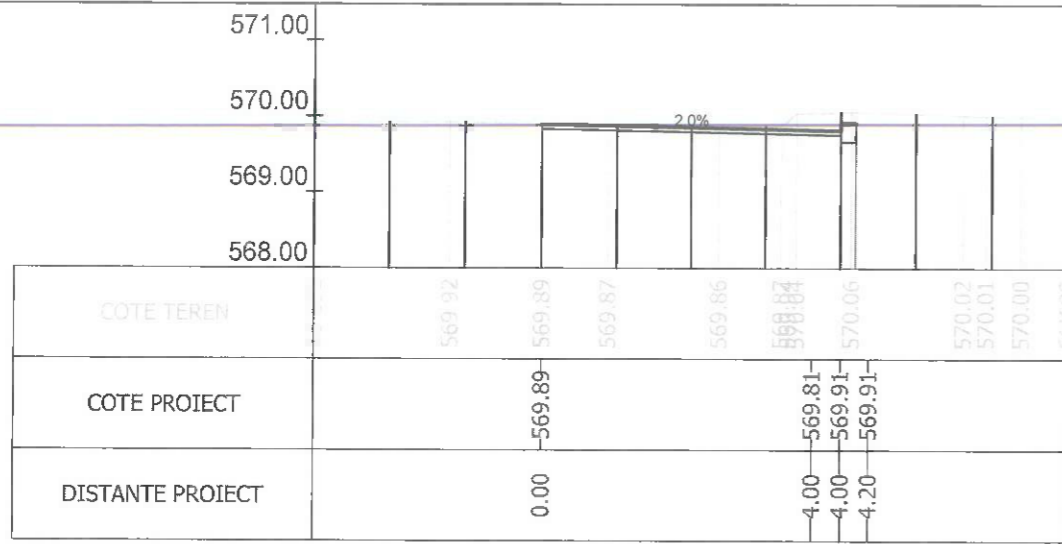

Sectiunea 230 - Km 3+321.916
Ax-Traseul 2

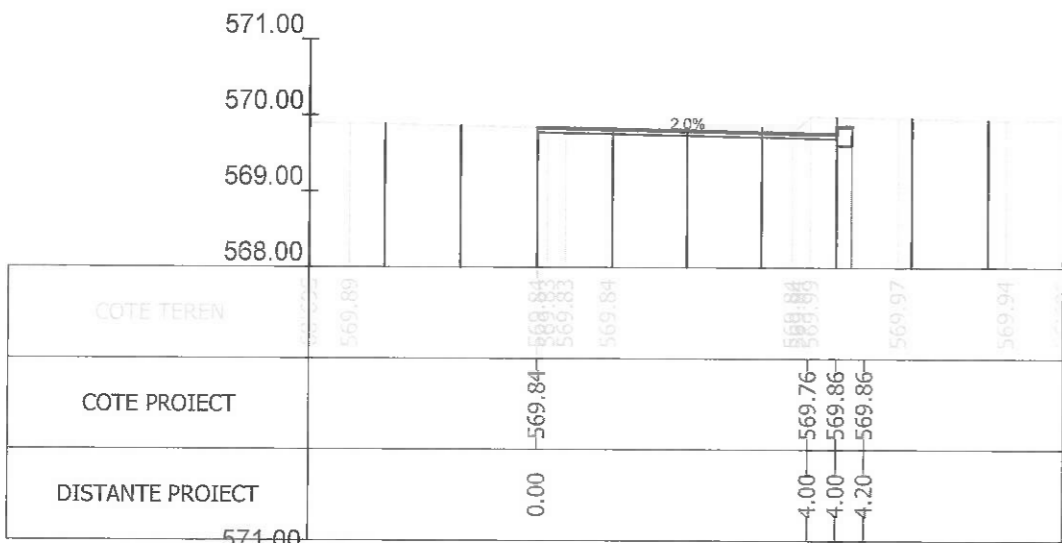

Sectiunea 232 - Km 3+323.229
Ax-Traseul 2

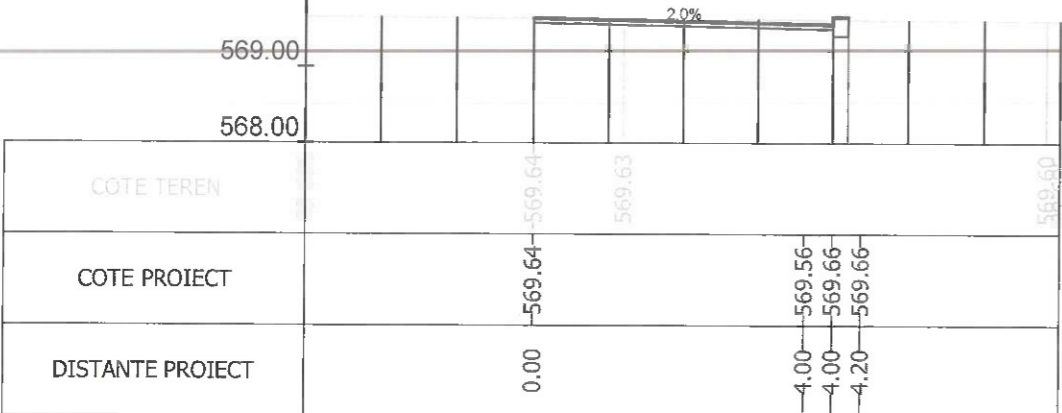

Sectiunea 234 - Km 3+333.018
Ax-Traseul 2

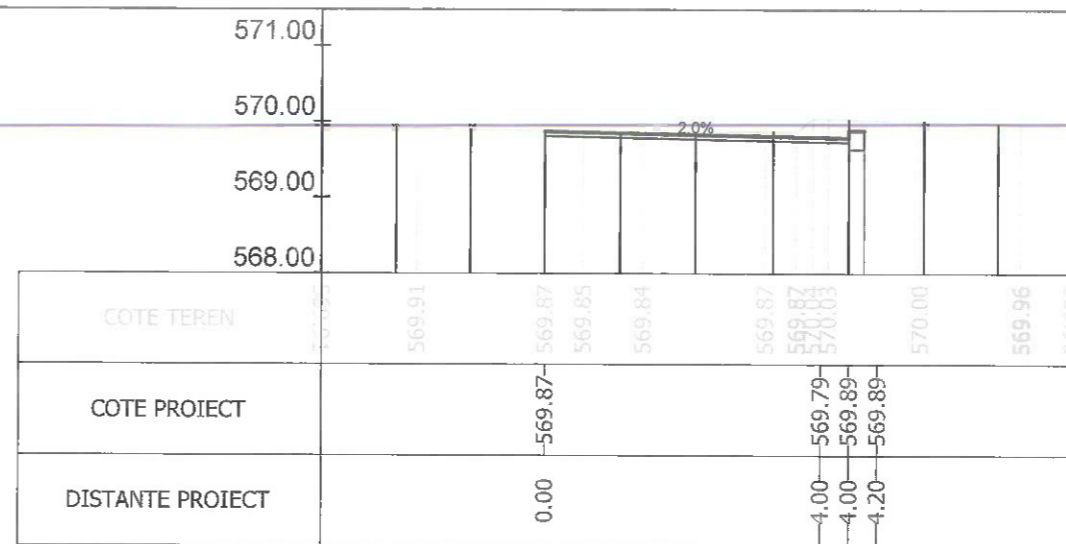

Sectiunea 231 - Km 3+322.572
Ax-Traseul 2

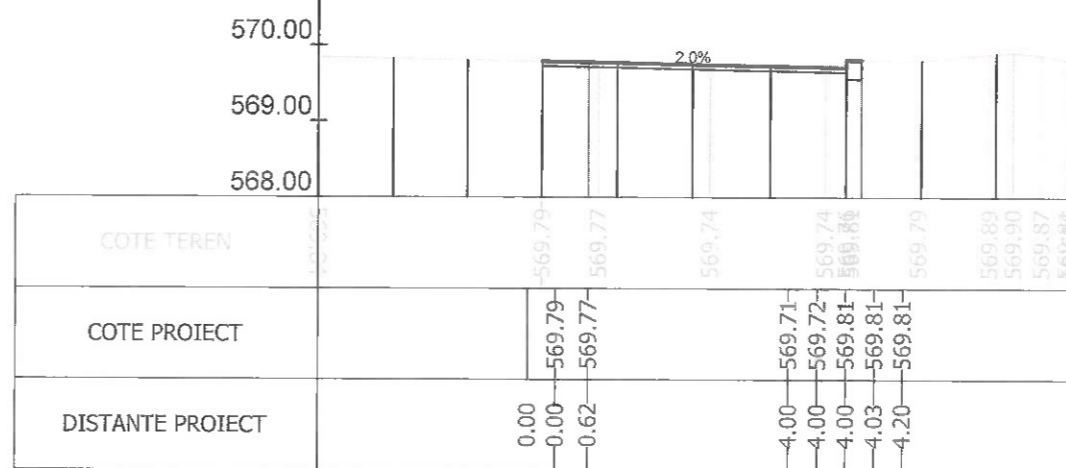

Sectiunea 233 - Km 3+325
Ax-Traseul 2

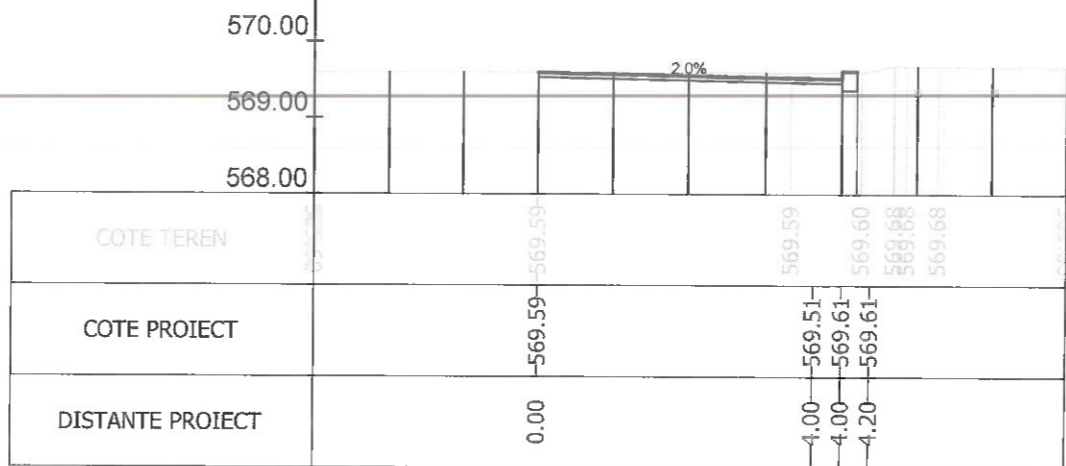

Sectiunea 235 - Km 3+342.806
Ax-Traseul 2

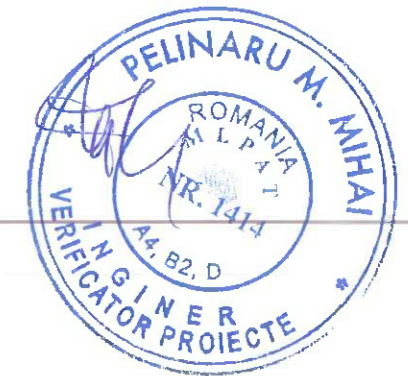

Index	A		Rev. 5
Beneficiar:		MUNICIPIUL BRASOV Bulevardul Eroilor 8, Brasov 500007	Nr. proiect 73 / 2020
Titlu proiect:		AMENAJARE BENZI DEDICATE TRANSPORTULUI PUBLIC IN MUNICIPIUL BRASOV SI TROTUARE ADIACENTE	Faza P.T.
Titlu plansa:		PROFILE TRANSVERSALE CURENTE	Nr. plansa PT-97
Sef Proiect	Ing. A. Buta	Scara 1/100	
Proiectat	Ing. A. Buta	Data	
Desenat	Ing. S. Patroi	07/2023	
Verificat			

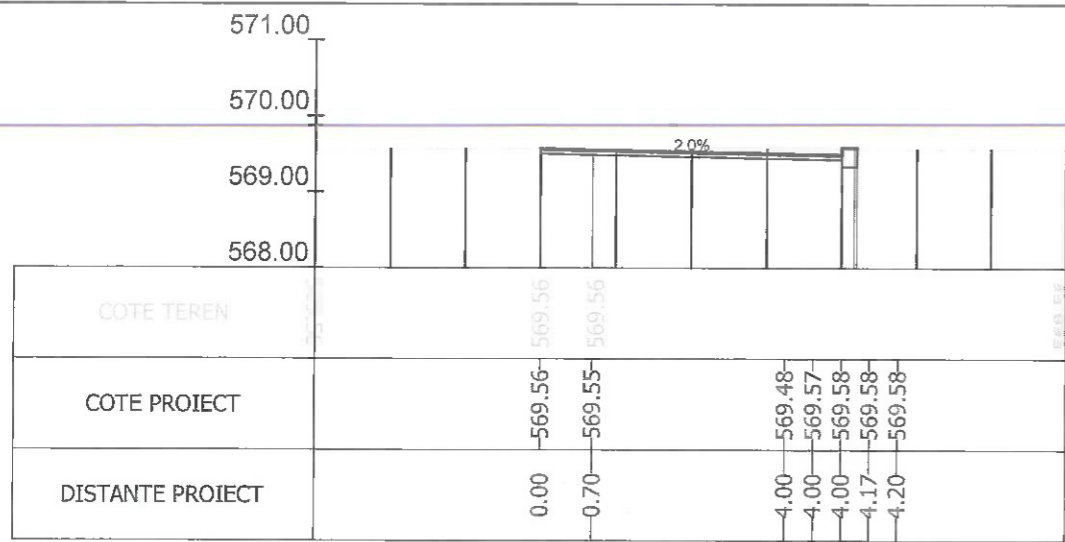

Sectiunea 236 - Km 3+350
Ax-Traseul 2

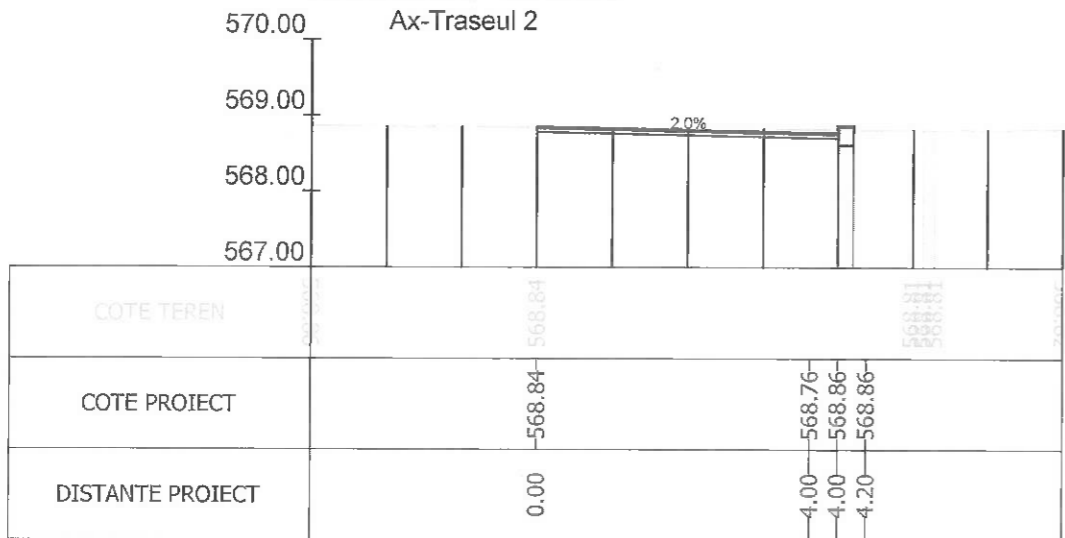

Sectiunea 238 - Km 3+400
Ax-Traseul 2

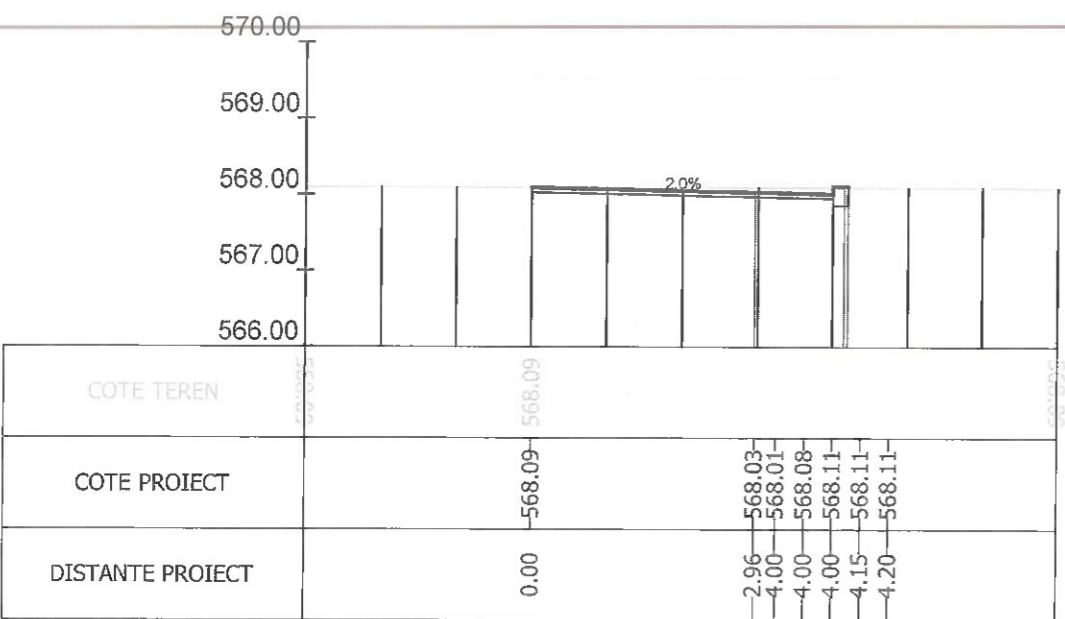

Sectiunea 240 - Km 3+450
Ax-Traseul 2

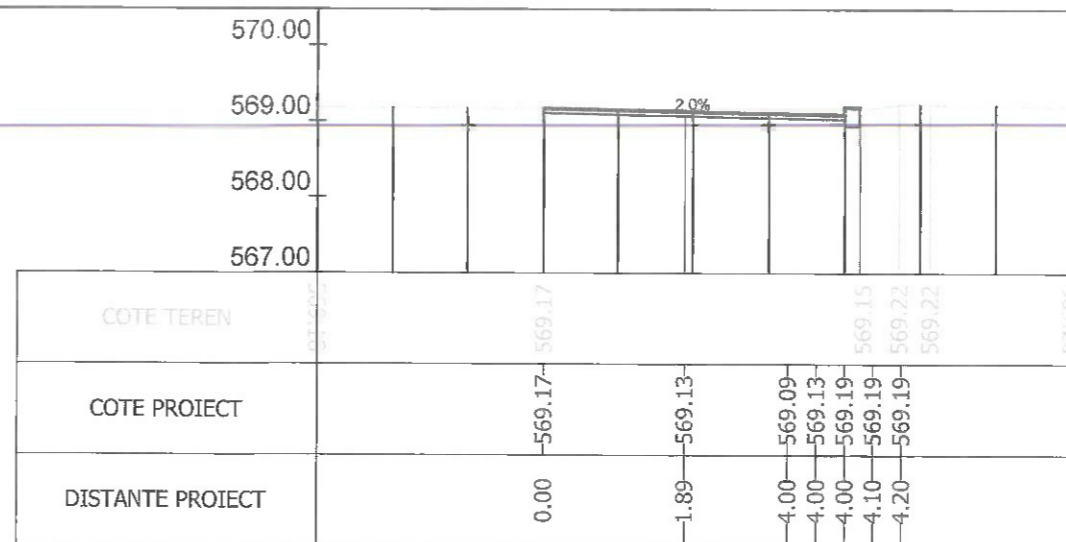

Sectiunea 237 - Km 3+375
Ax-Traseul 2

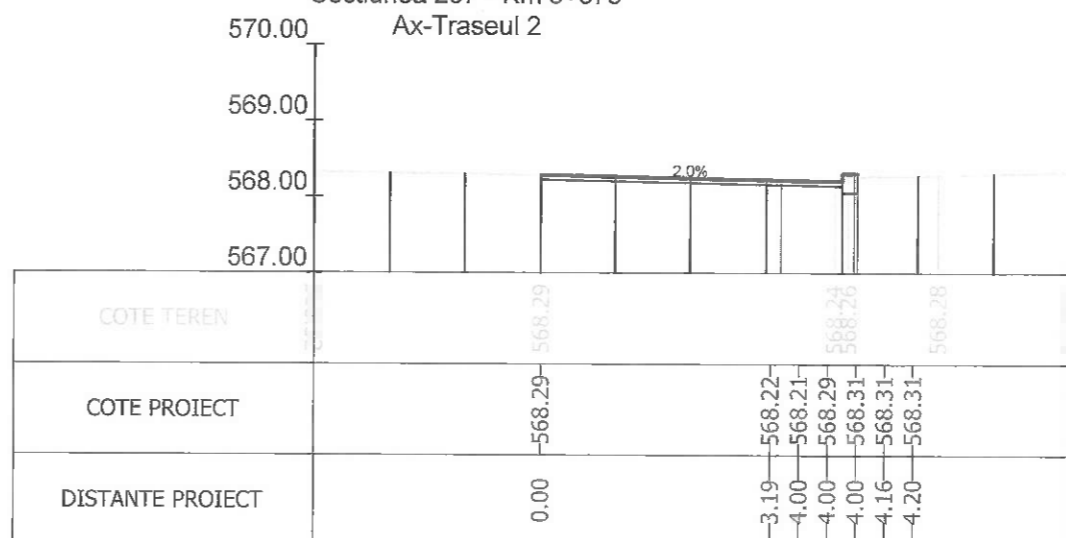

Sectiunea 239 - Km 3+425
Ax-Traseul 2

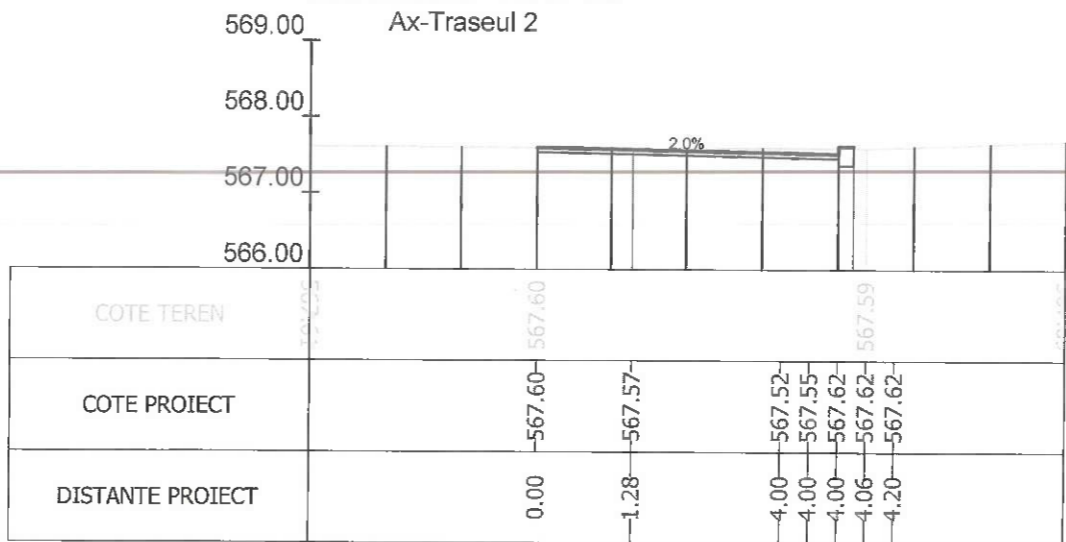

Sectiunea 241 - Km 3+475
Ax-Traseul 2



Index	Data	Rev. 5
A		
		Beneficiar: MUNICIPIUL BRASOV Bulevardul Eroilor 8, Brasov 500007
Sef Proiect	Ing. A. Buta	Nr. proiect: 73 / 2020
Proiectat	Ing. A. Buta	Faza P.T.
Desenat	Ing. S. Patroi	Nr. plansa: PT-98
Verificat		
Scara: 1/100		Titlu proiect: AMENAJARE BENZI DEDICATE TRANSPORTULUI PUBLIC IN MUNICIPIUL BRASOV SI TROTUARE ADIACENTE
Data: 07/2023		Titlu plansa: PROFILE TRANSVERSALE CURENTE

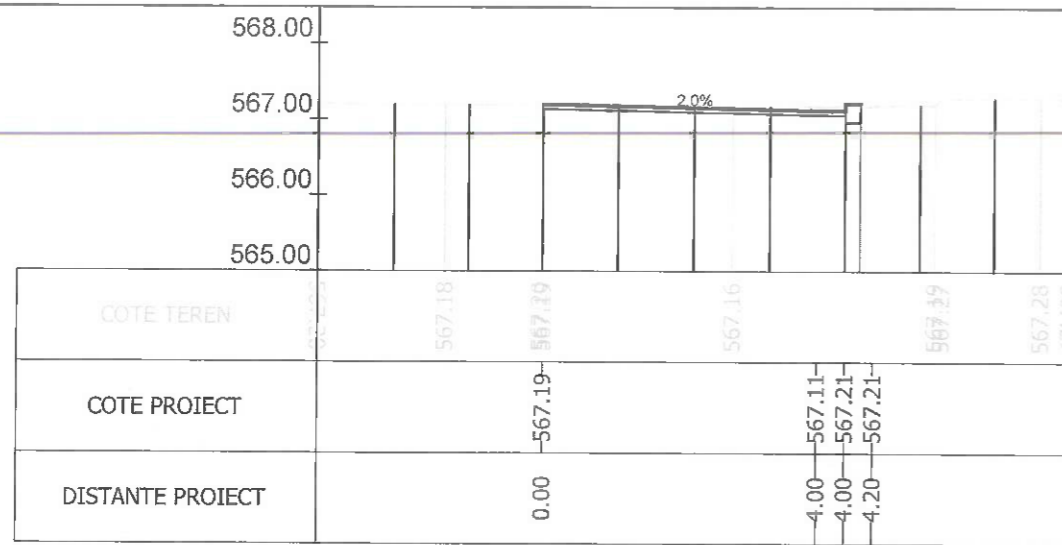

Sectiunea 242 - Km 3+500
Ax-Traseul 2

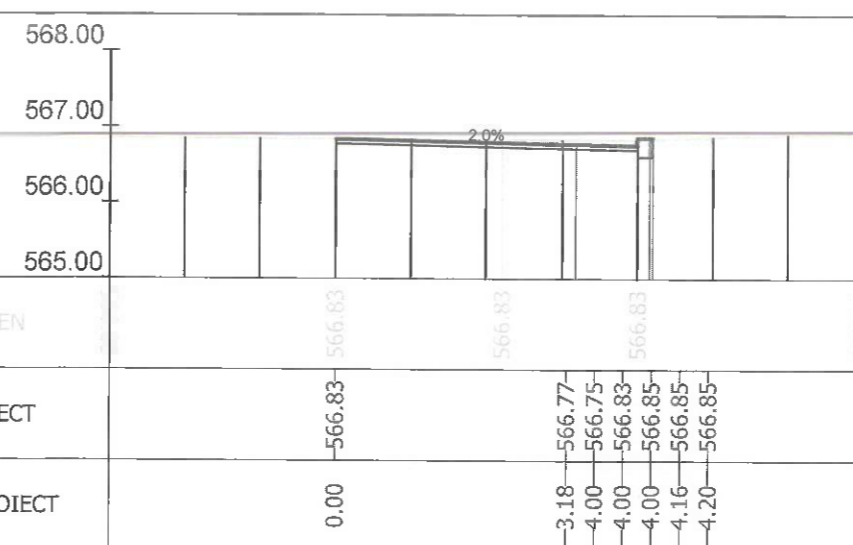
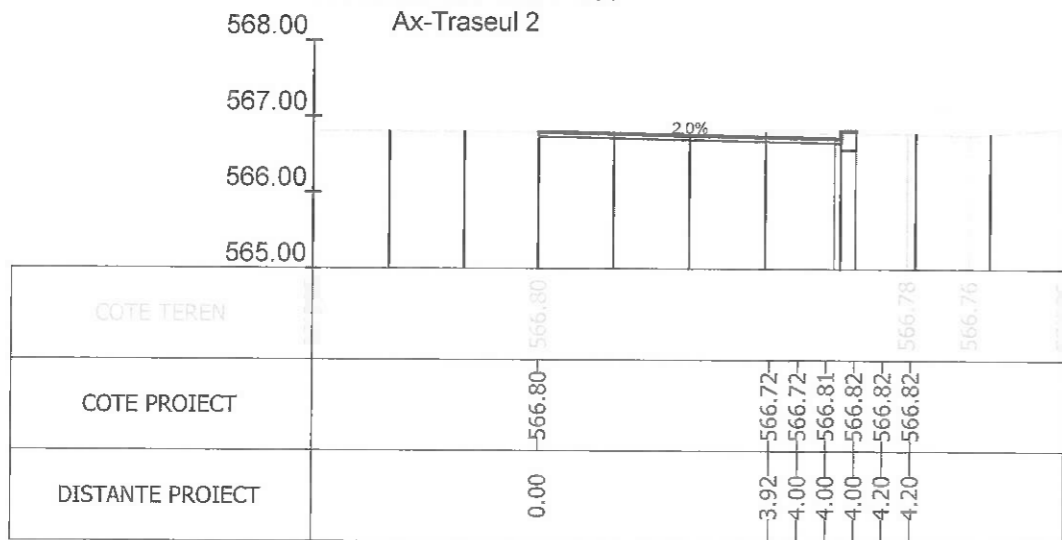

Sectiunea 243 - Km 3+525
Ax-Traseul 2

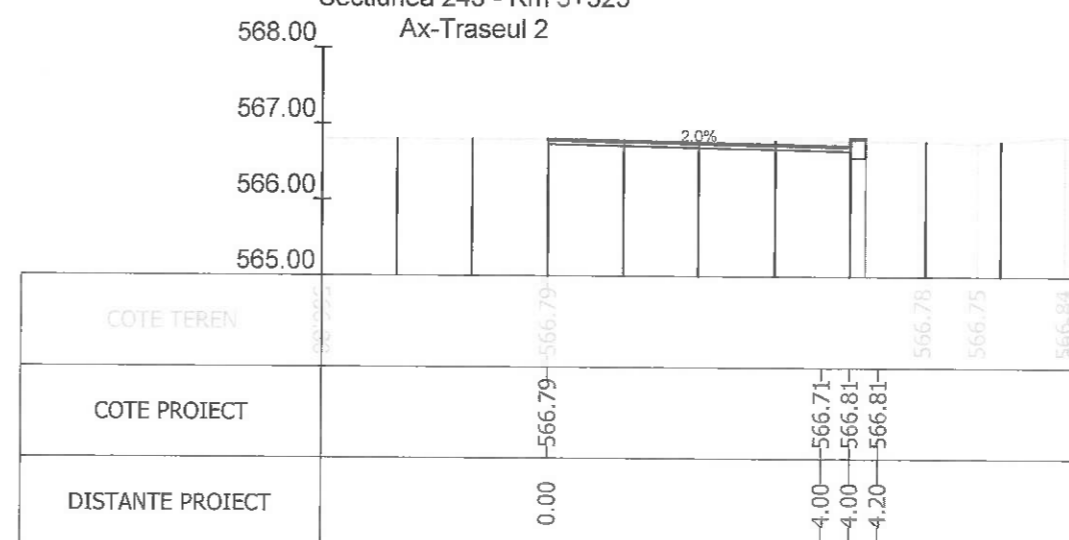

Sectiunea 244 - Km 3+543.804
Ax-Traseul 2

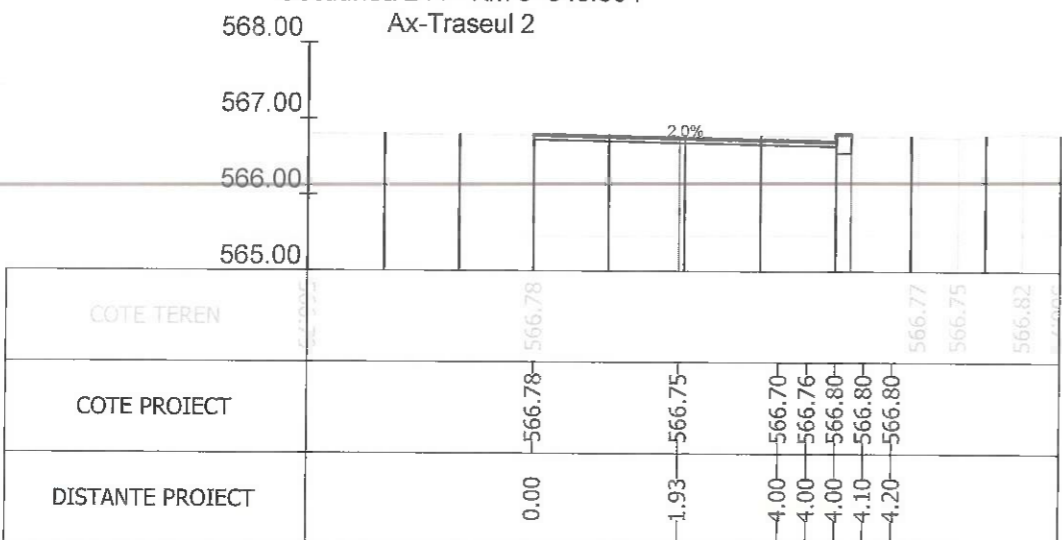

Sectiunea 246 - Km 3+550
Ax-Traseul 2

Sectiunea 245 - Km 3+546.151
Ax-Traseul 2

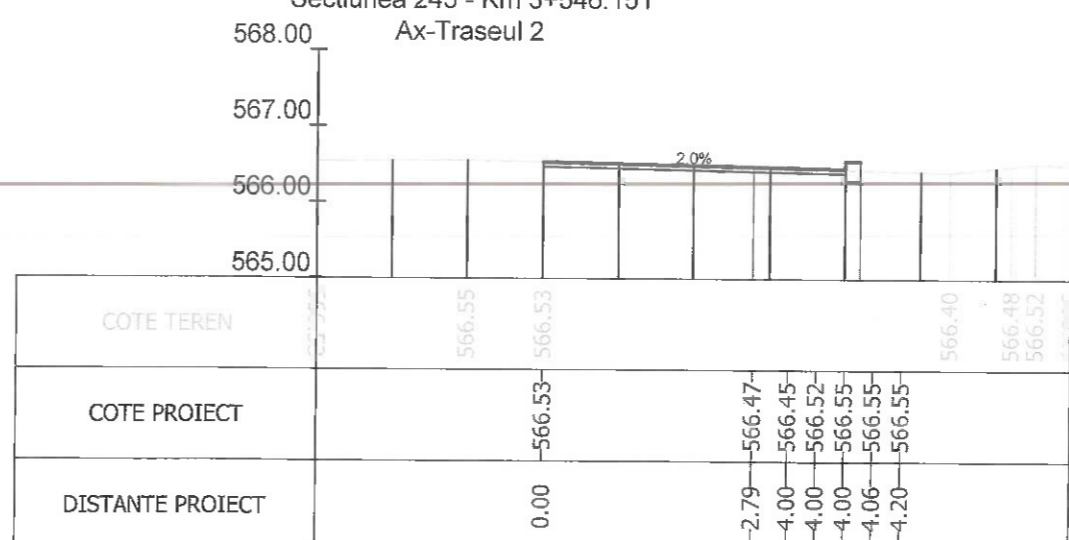

Sectiunea 247 - Km 3+575
Ax-Traseul 2



Index	Data	Observatii	Rev. 5
A			
		Beneficiar:	MUNICIPIUL BRASOV Bulevardul Eroilor 8, Brasov 500007
Sef Proiect: Ing. A. Buta Proiectat: Ing. A. Buta Desenat: Ing. S. Patroi Verificat:		Titlu proiect:	AMENAJARE BENZI DEDICATE TRANSPORTULUI PUBLIC IN MUNICIPIUL BRASOV SI TROTUARE ADIACENTE
Scara: 1/100 Data: 07/2023		Titlu plansa:	PROFILE TRANSVERSALE CURENTE
		Nr. proiect:	73 / 2020
		Faza:	P.T.
		Nr. plansa:	PT-99

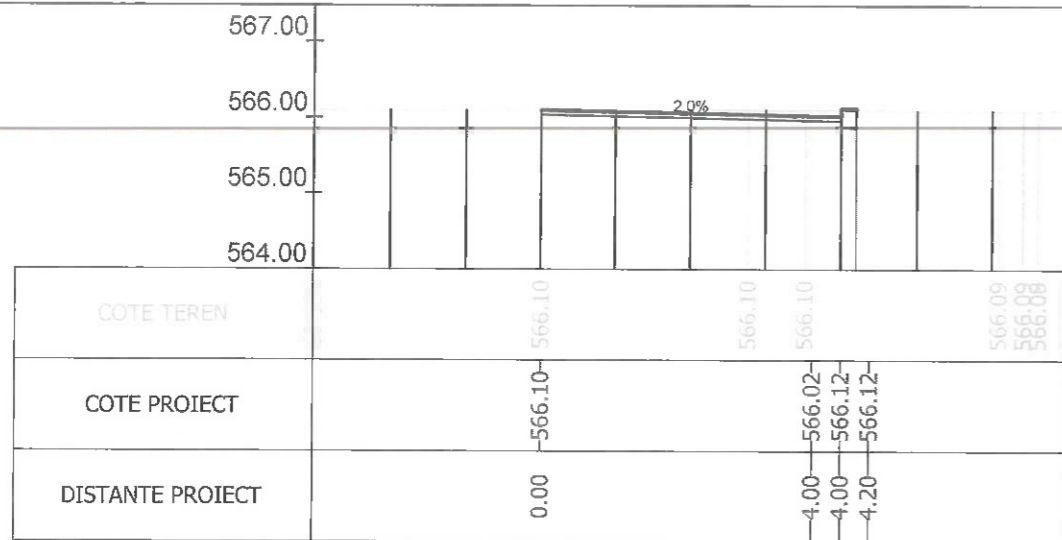

Sectiunea 248 - Km 3+600
Ax-Traseul 2

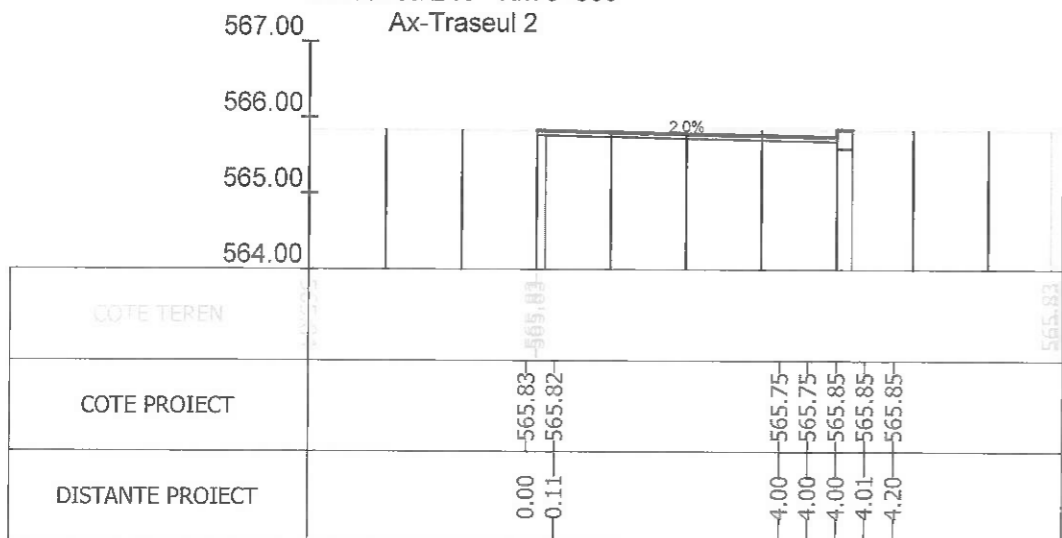

Sectiunea 250 - Km 3+625
Ax-Traseul 2

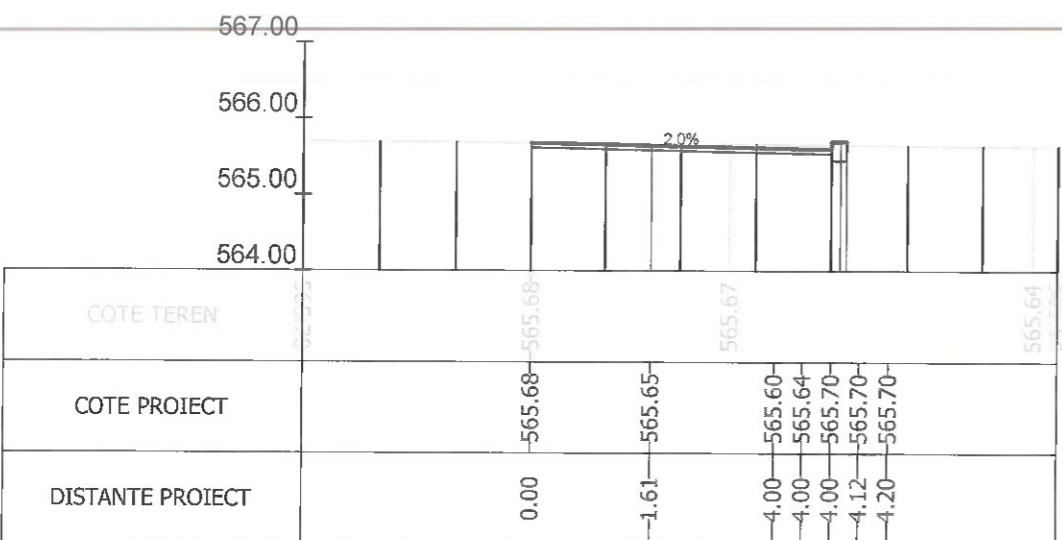

Sectiunea 252 - Km 3+650
Ax-Traseul 2

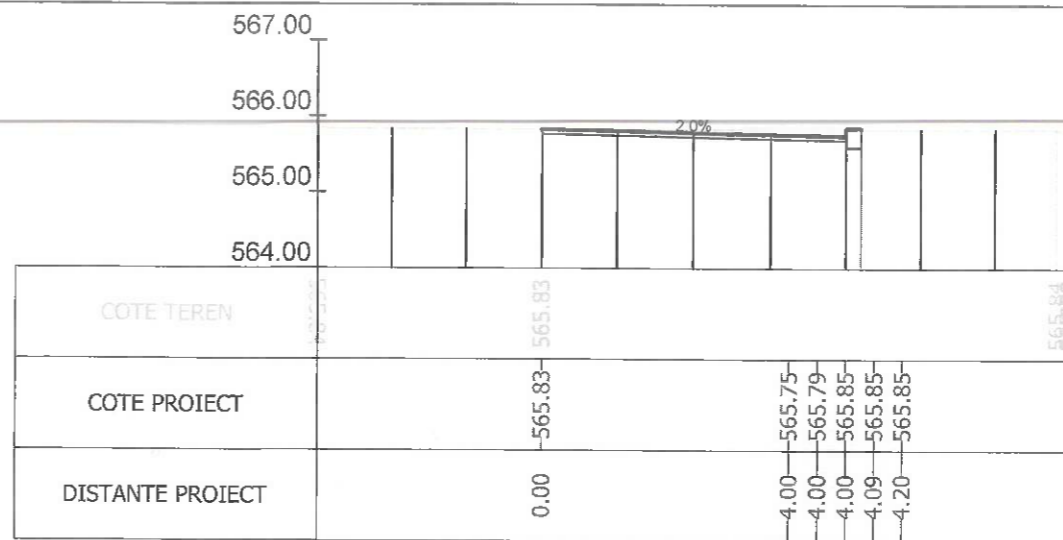

Sectiunea 249 - Km 3+624.840
Ax-Traseul 2

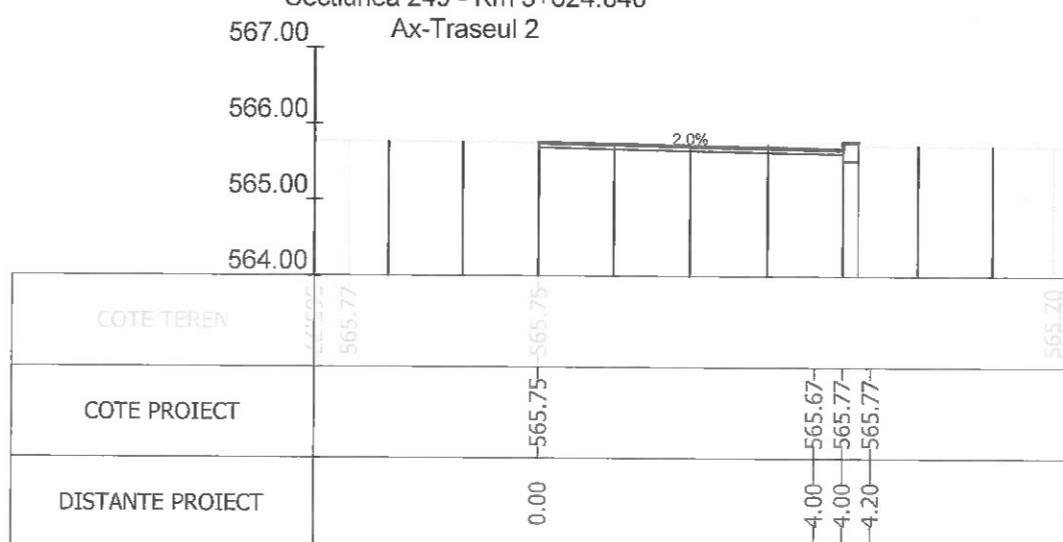

Sectiunea 251 - Km 3+635.626
Ax-Traseul 2

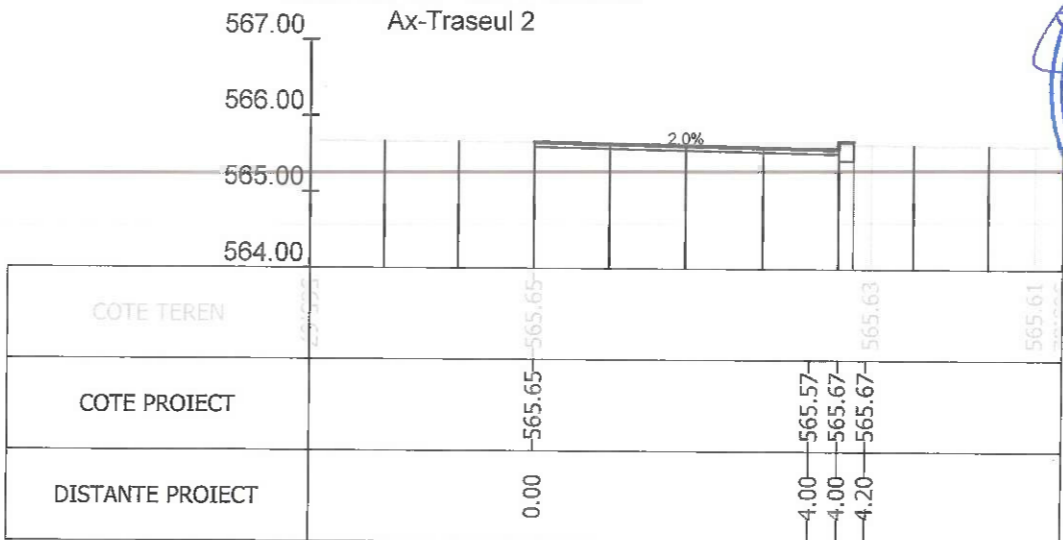

Sectiunea 253 - Km 3+654.954
Ax-Traseul 2

index	Data	Clasificarii	Rev. 5
A			
		Beneficiar:	MUNICIPIUL BRASOV Bulevardul Eroilor 8, Brasov 500007
Sef Proiect	Ing. A. Buta	Scara	Nr. proiect
Proiectat	Ing. A. Buta	1/100	73 / 2020
Desenat	Ing. S. Patroi	Data	Faza
Verificat		07/2023	P.T.
		Titlu proiect:	AMENAJARE BENZI DEDICATE TRANSPORTULUI PUBLIC IN MUNICIPIUL BRASOV SI TROTUARE ADIACENTE
		Titlu plansa:	PROFILE TRANSVERSALE CURENTE
			Nr. plansa
			PT-100



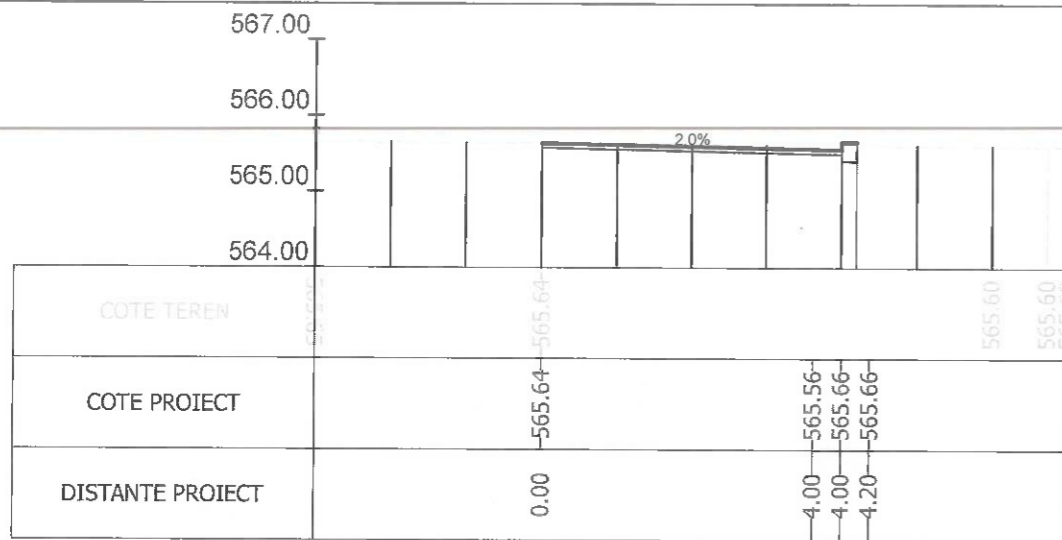

Sectiunea 254 - Km 3+658.462

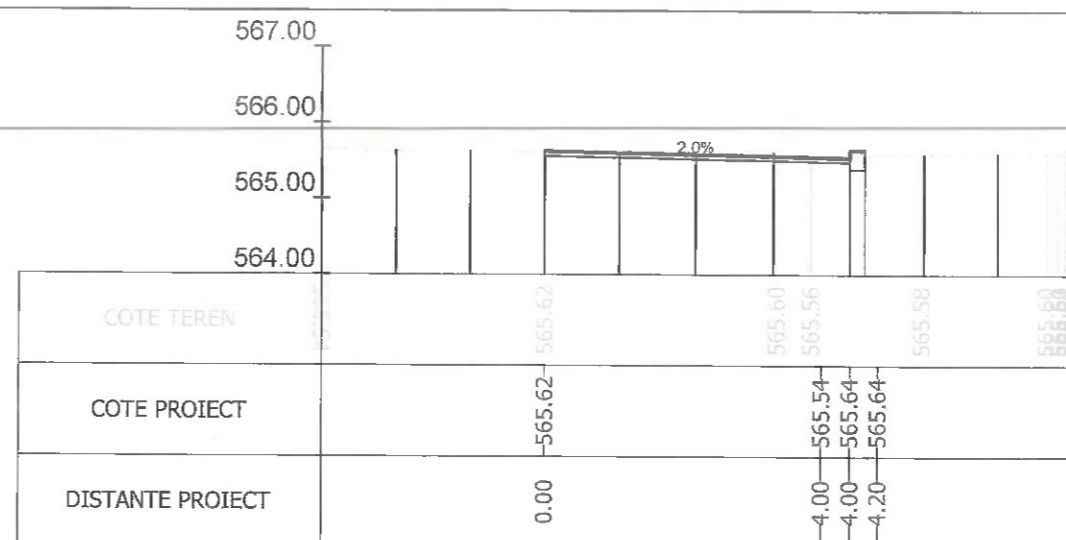
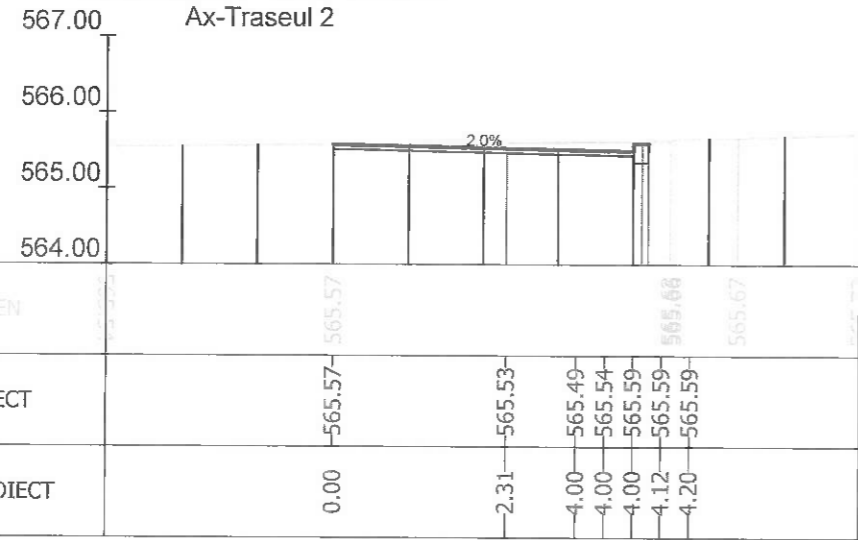

Sectiunea 255 - Km 3+661.970

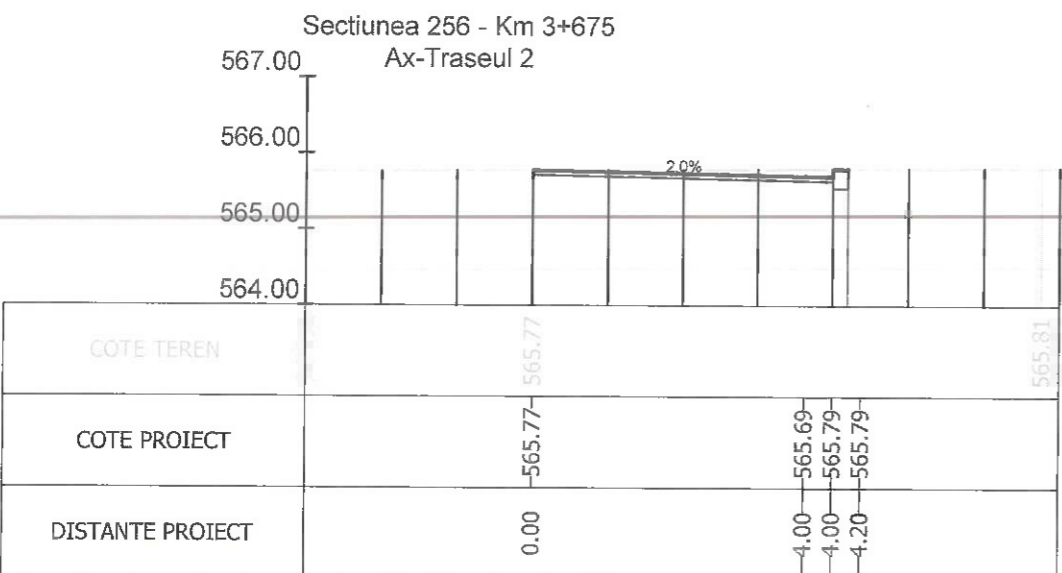
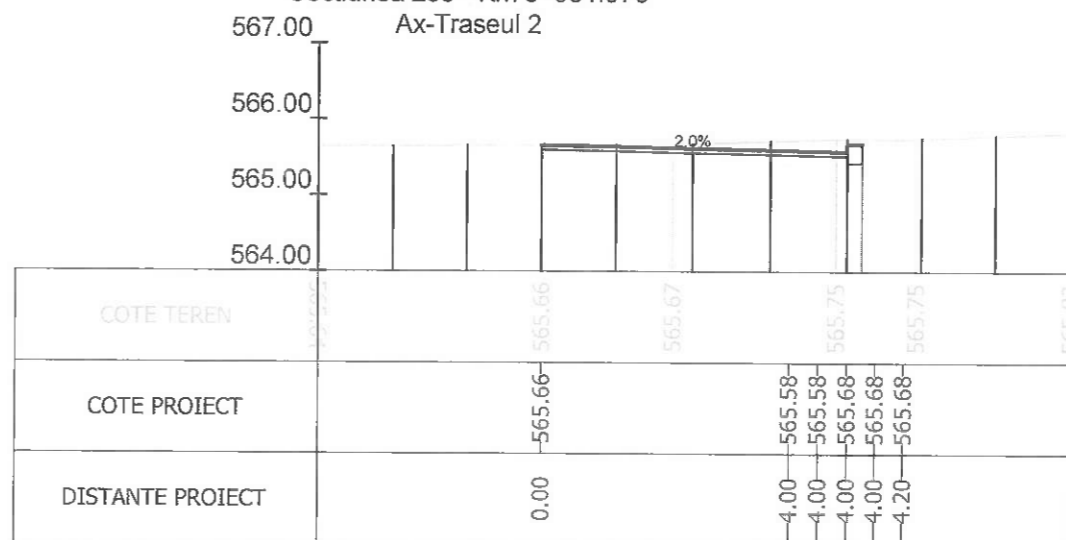

Sectiunea 256 - Km 3+675



Sectiunea 258 - Km 3+700



Sectiunea 257 - Km 3+686.069

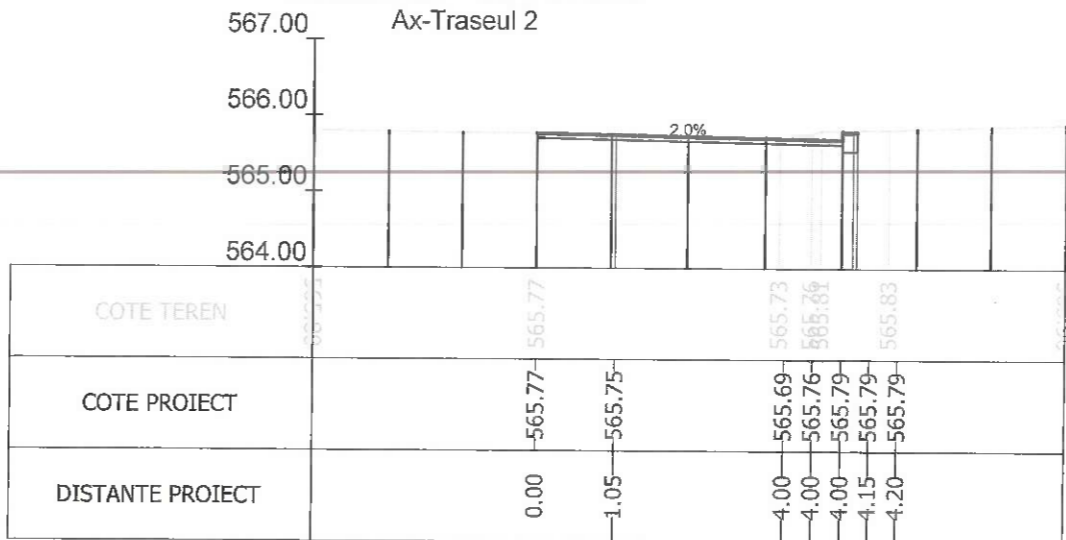

Sectiunea 259 - Km 3+725



Index	A		Rev. 5
Beneficiar:	MUNICIPIUL BRASOV Bulevardul Eroilor 8, Brasov 500007		Nr. proiect 73 / 2020
Titlu proiect:	AMENAJARE BENZI DEDICATE TRANSPORTULUI PUBLIC IN MUNICIPIUL BRASOV SI TROTUARE ADIACENTE		Faza P.T.
Titlu plansa:	PROFILE TRANSVERSALE CURENTE		Nr. plansa PT-101
Sef Proiect	Ing. A. Buta	Scara	1/100
Proiectat	Ing. A. Buta	Data	07/2023
Desenat	Ing. S. Patroi		
Verificat			

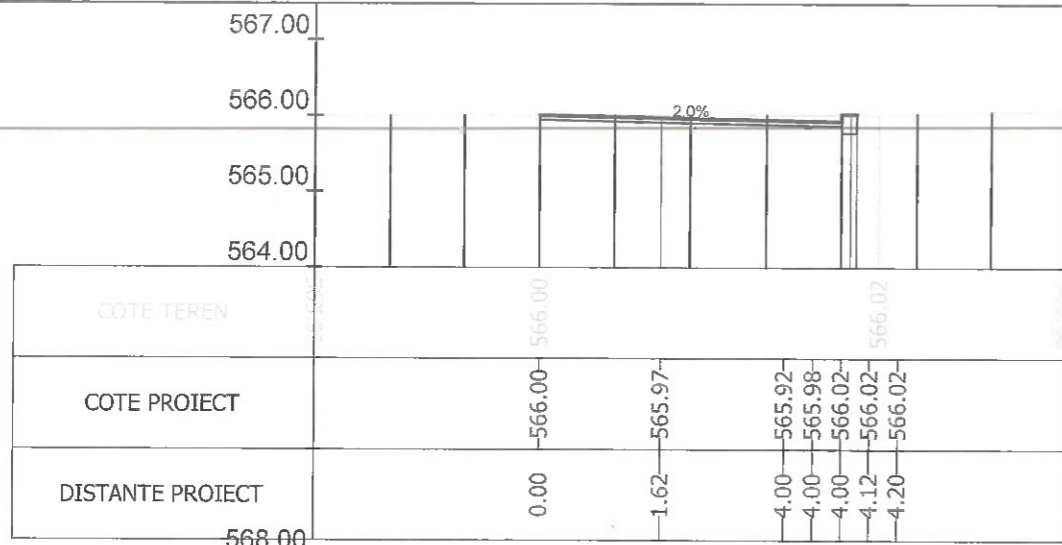

Sectiunea 260 - Km 3+750
Ax-Traseul 2

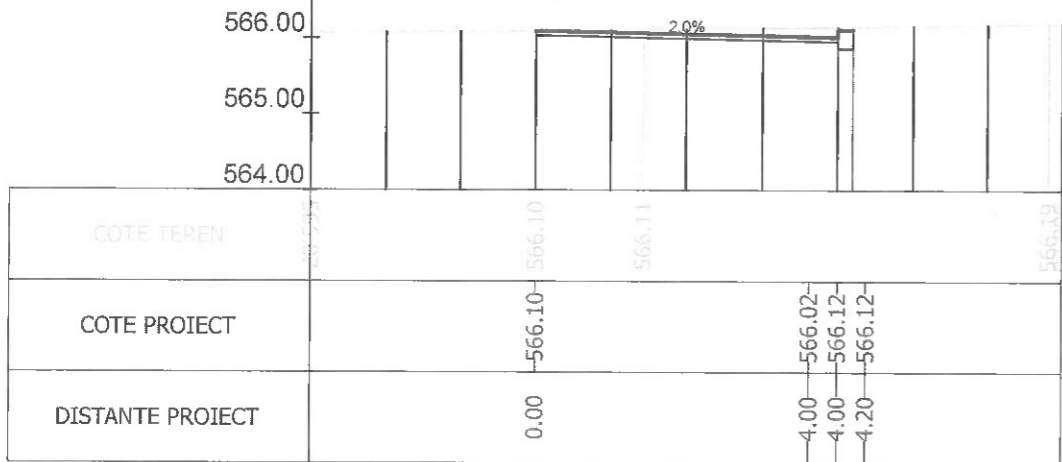

Sectiunea 262 - Km 3+800
Ax-Traseul 2

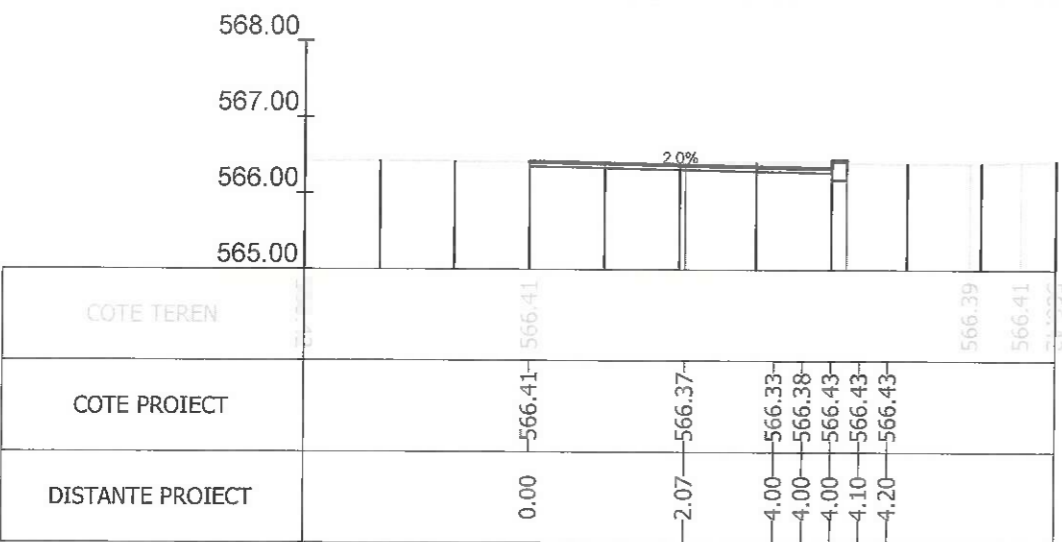

Sectiunea 264 - Km 3+850
Ax-Traseul 2

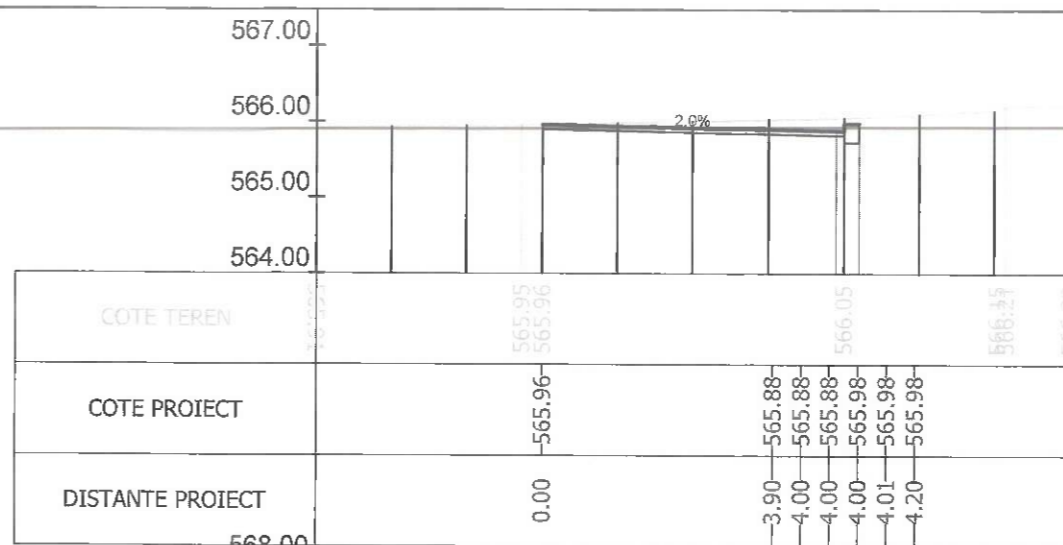

Sectiunea 261 - Km 3+775
Ax-Traseul 2

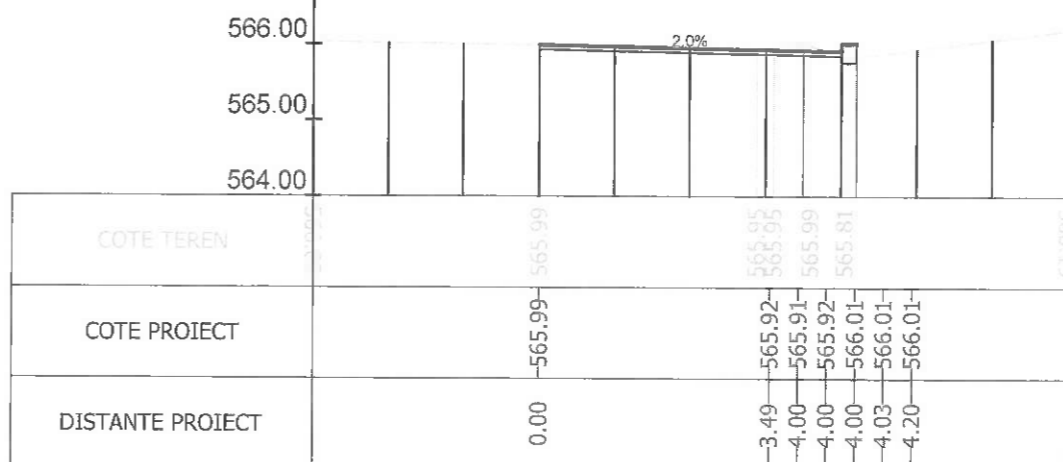

Sectiunea 263 - Km 3+825
Ax-Traseul 2

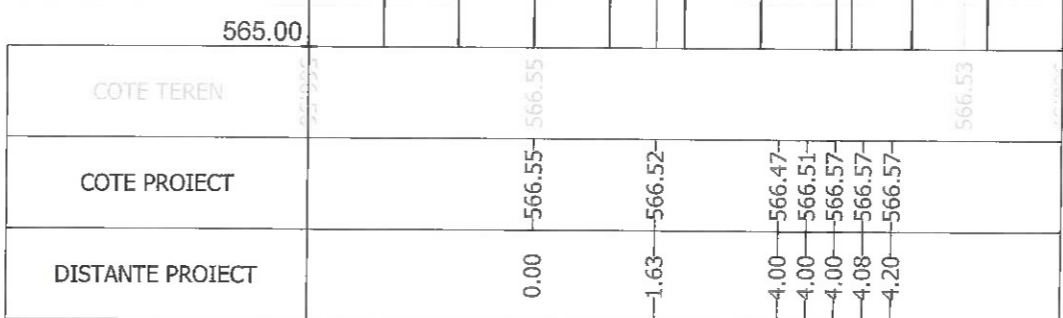

Sectiunea 265 - Km 3+875
Ax-Traseul 2

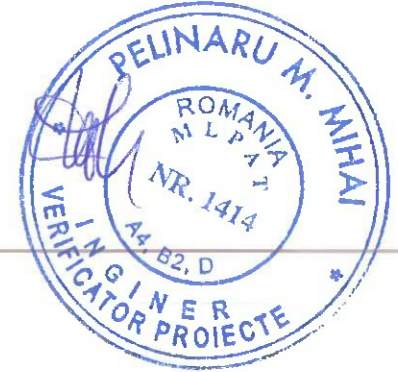

Index	Data	Observatii	Rev. 5
A			
		Beneficiar:	MUNICIPIUL BRASOV Bulevardul Eroilor 8, Brasov 500007
Sef Proiect: Ing. A. Buta Proiectat: Ing. A. Buta Desenat: Ing. S. Patroi Verificat:		Titlu proiect:	AMENAJARE BENZI DEDICATE TRANSPORTULUI PUBLIC IN MUNICIPIUL BRASOV SI TROTUARE ADIACENTE
Scara: 1/100 Data: 07/2023		Titlu plansa:	PROFILE TRANSVERSALE CURENTE
		Nr. proiect:	73 / 2020
		Faza:	P.T.
		Nr. plansa:	PT-102

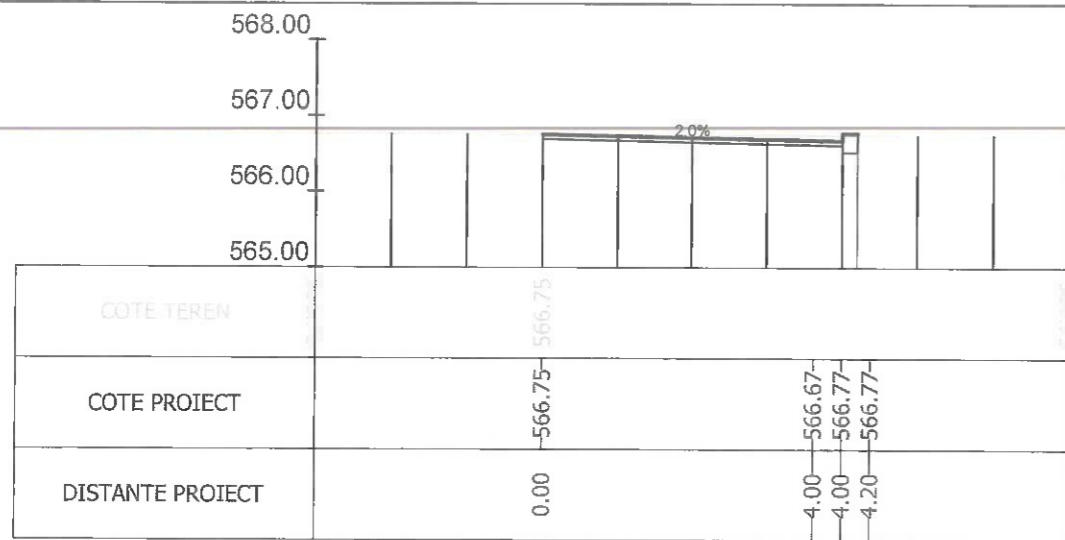

Sectiunea 266 - Km 3+900
Ax-Traseul 2

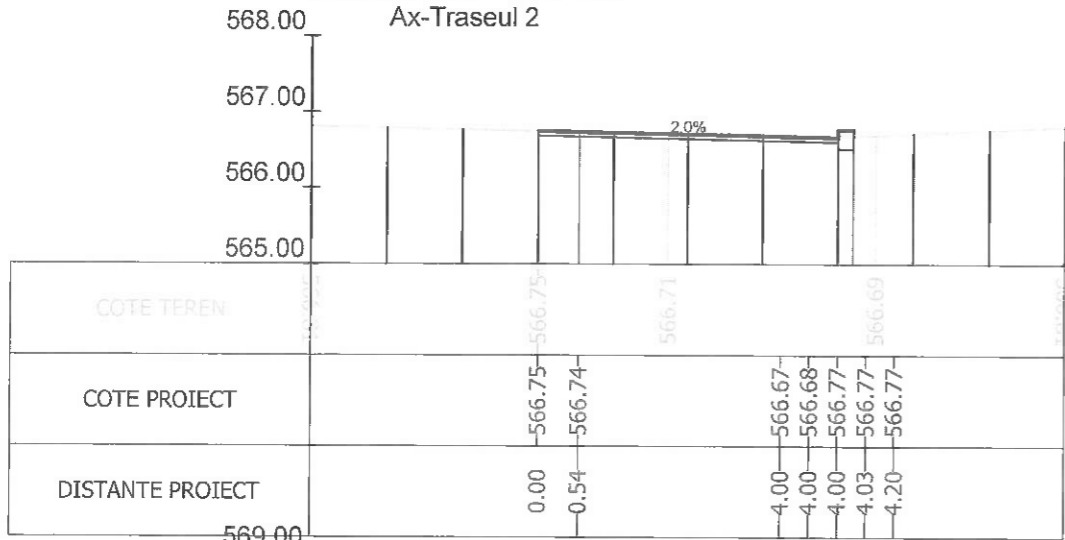

Sectiunea 268 - Km 3+925
Ax-Traseul 2

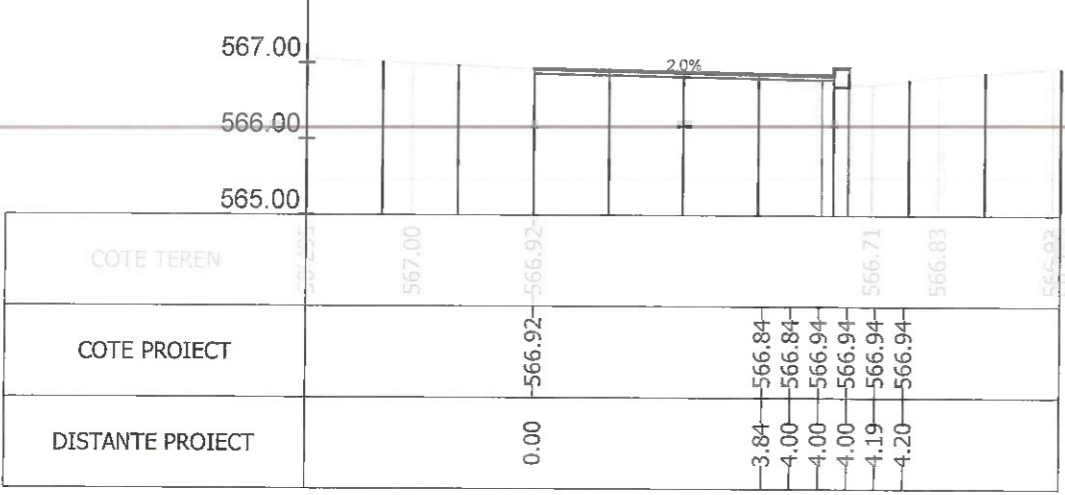

Sectiunea 270 - Km 3+952.719
Ax-Traseul 2

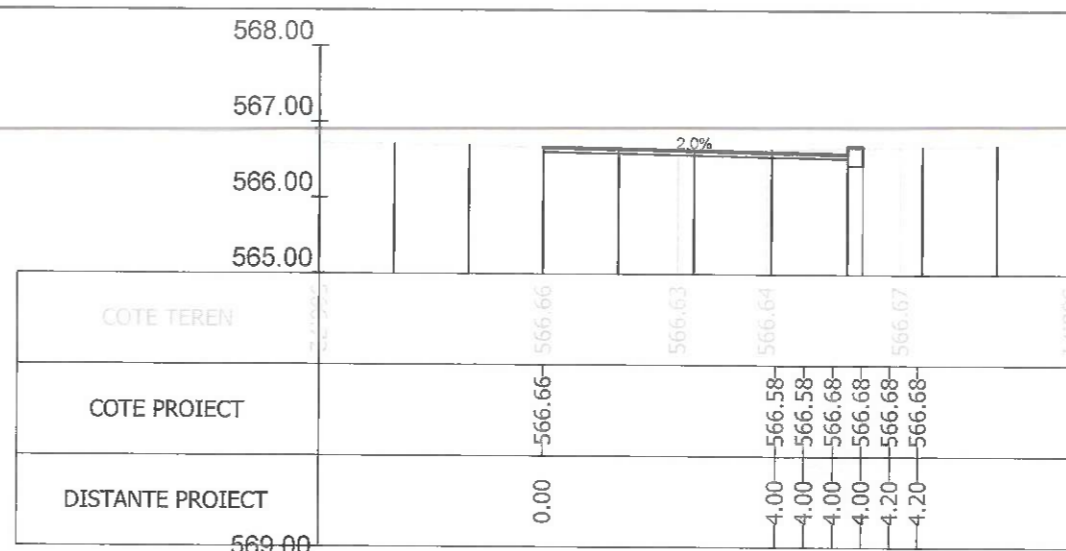

Sectiunea 267 - Km 3+923.437
Ax-Traseul 2

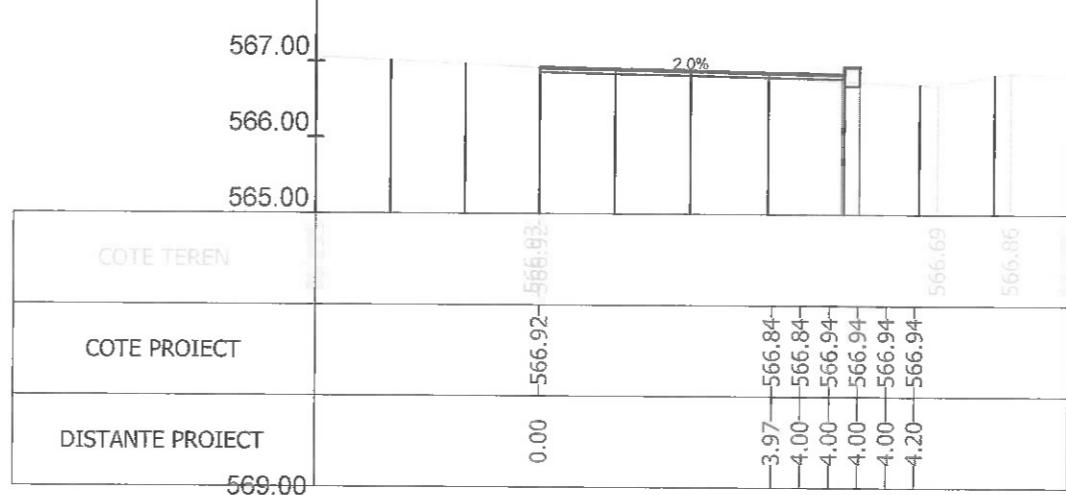

Sectiunea 269 - Km 3+950
Ax-Traseul 2

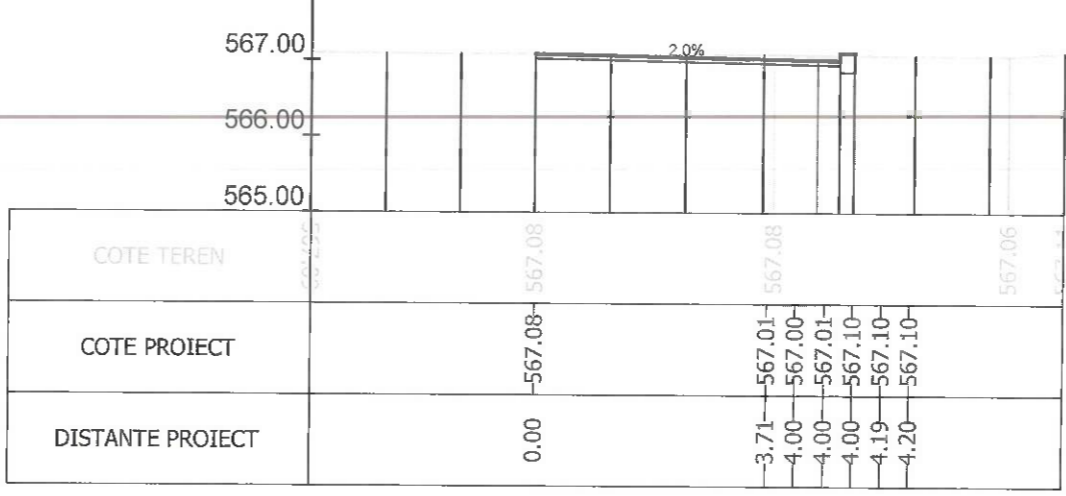

Sectiunea 271 - Km 3+975
Ax-Traseul 2

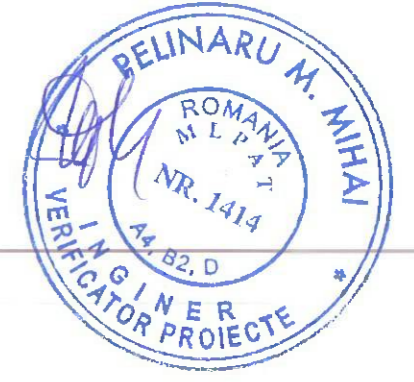

Index	Data	Revisii	Rev. 5
A			
		Beneficiar:	MUNICIPIUL BRASOV Bulevardul Eroilor 8, Brasov 500007
Sef Proiect: Ing. A. Buta Proiectat: Ing. A. Buta Desenat: Ing. S. Patroi Verificat:		Nr. proiect:	73 / 2020
Scara: 1/100 Data: 07/2023		Faza:	P.T.
		Nr. plansa:	PT-103
		Titlu proiect: AMENAJARE BENZI DEDICATE TRANSPORTULUI PUBLIC IN MUNICIPIUL BRASOV SI TROTUARE ADIACENTE	
		Titlu plansa: PROFILE TRANSVERSALE CURENTE	

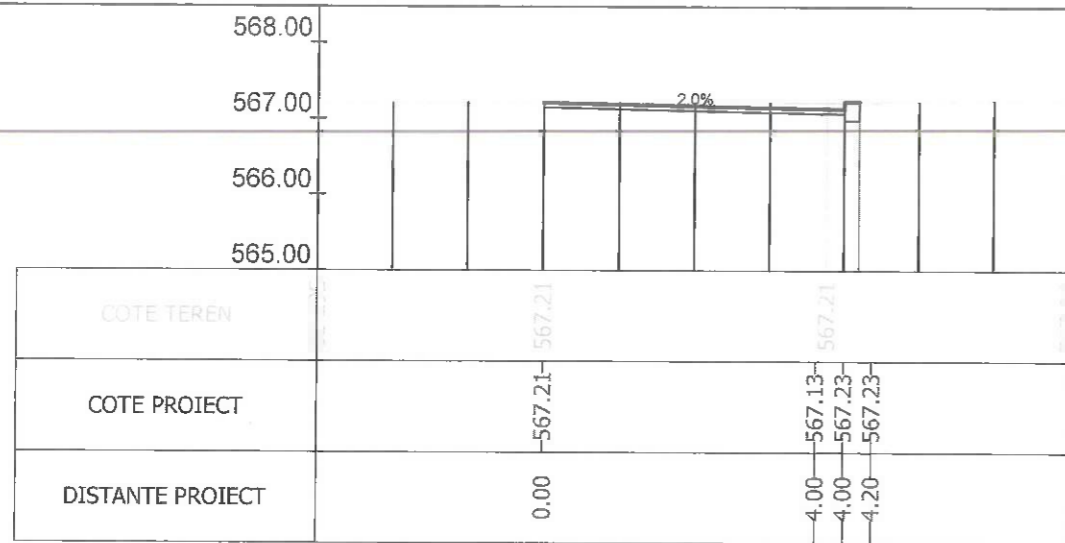

Sectiunea 272 - Km 4+000

Ax-Traseul 2

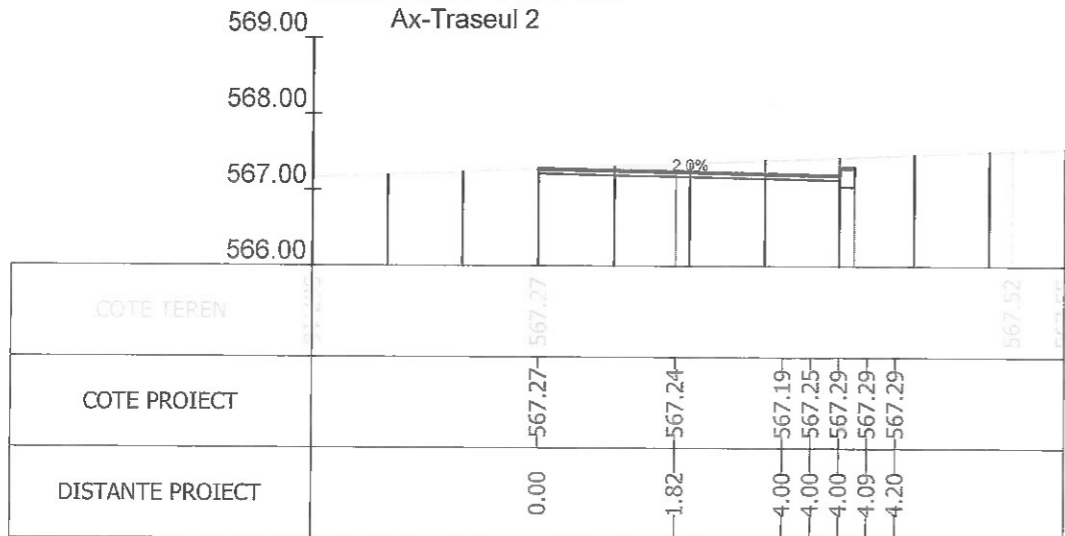

Sectiunea 274 - Km 4+050

Ax-Traseul 2

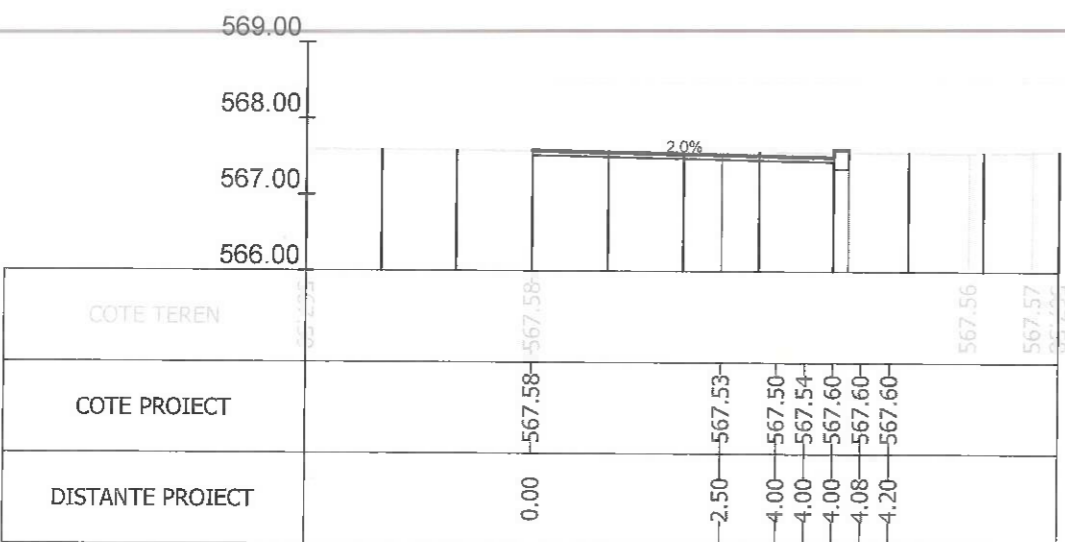

Sectiunea 276 - Km 4+075

Ax-Traseul 2

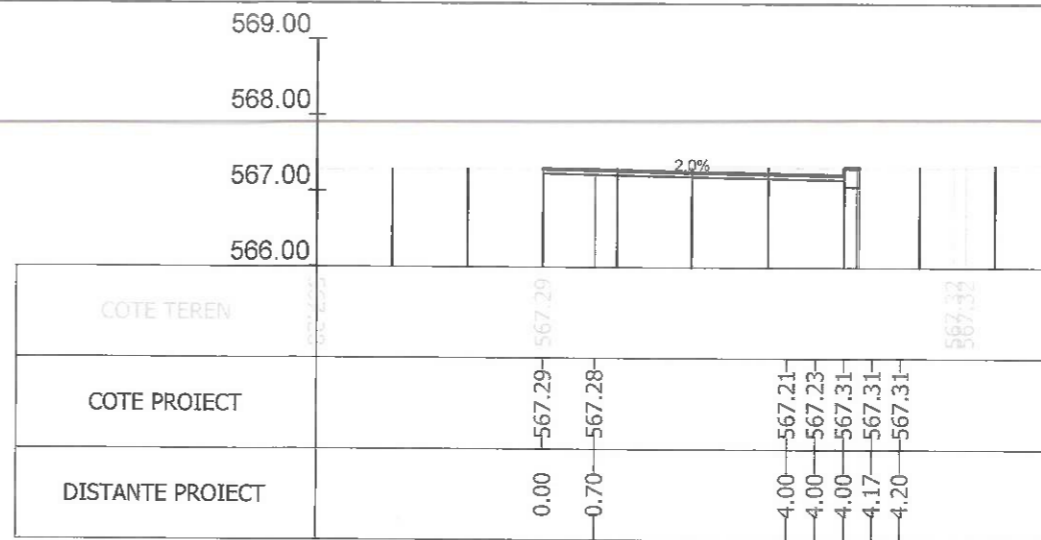

Sectiunea 273 - Km 4+025

Ax-Traseul 2

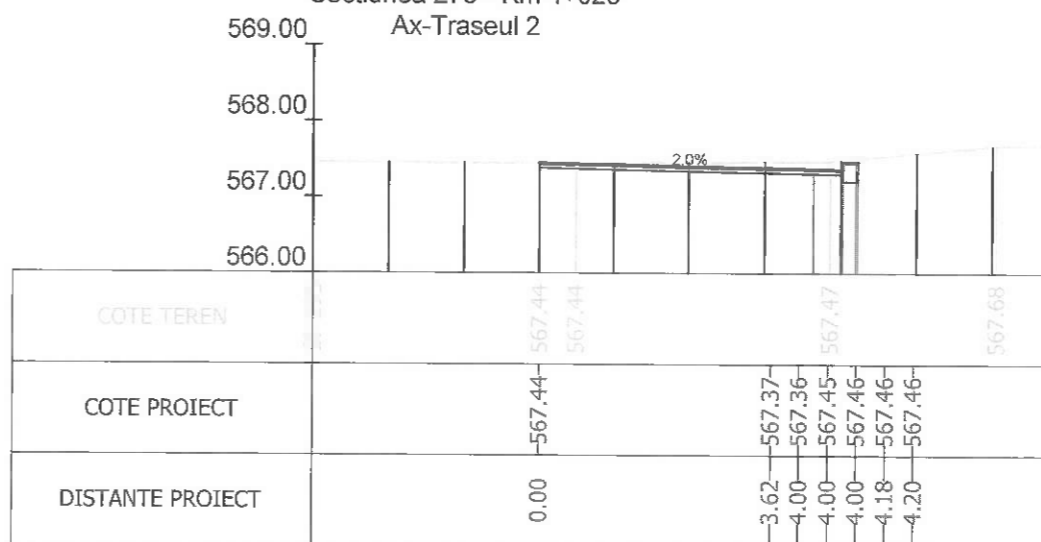

Sectiunea 275 - Km 4+065.983

Ax-Traseul 2

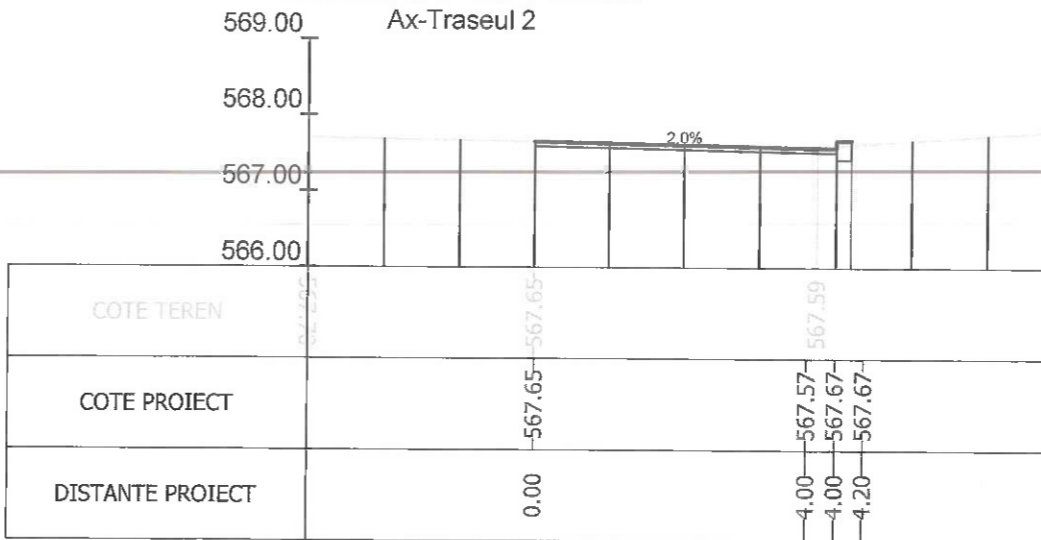

Sectiunea 277 - Km 4+100

Ax-Traseul 2

Index	Data	Observatii	Rev. 5
A			
		Beneficiar:	MUNICIPIUL BRASOV Bulevardul Eroilor 8, Brasov 500007
<small>SEEL - PROIECTARE NR. 17 BUCUR 1911, 2 ETIJA 4, VILLOROMI TURZI, TEL.: +40 37 454 0049, EMAIL: OFFICE@HENTZA.RO</small>		Titlu proiect:	AMENAJARE BENZI DEDICATE TRANSPORTULUI PUBLIC IN MUNICIPIUL BRASOV SI TROTUARE ADIACENTE
Sef Proiect	Ing. A. Buta	Scara	Nr. proiect 73 / 2020
Proiectat	Ing. A. Buta	1/100	Faza P.T.
Desenat	Ing. S. Patroi	Data	Titlu plansa:
Verificat		07/2023	PROFILI TRANSVERSALE CURENTE
			Nr. plansa PT-104

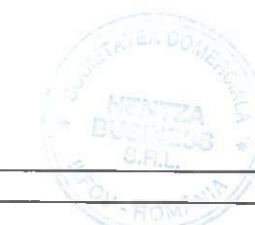

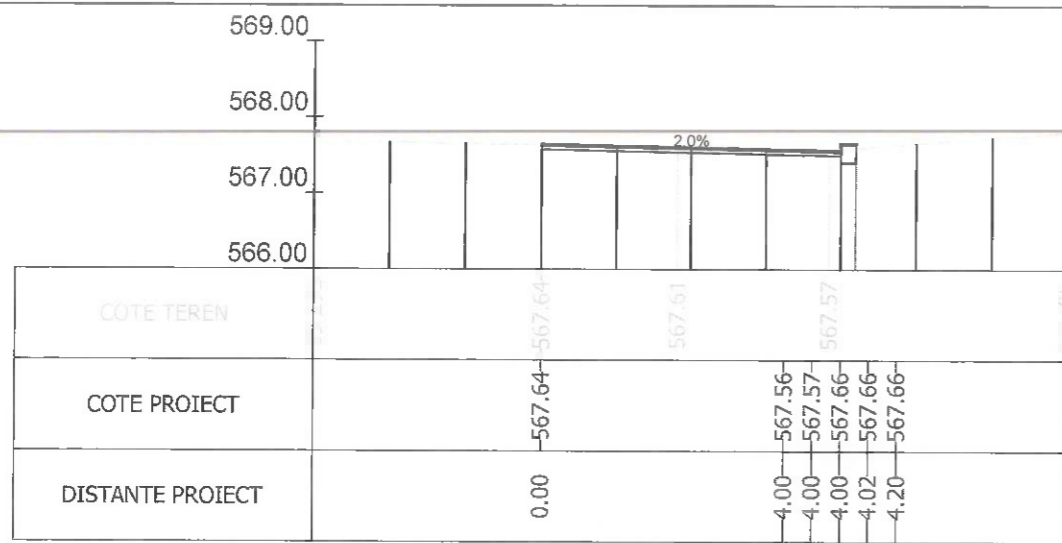

Sectiunea 278 - Km 4+102.825

Ax-Traseul 2

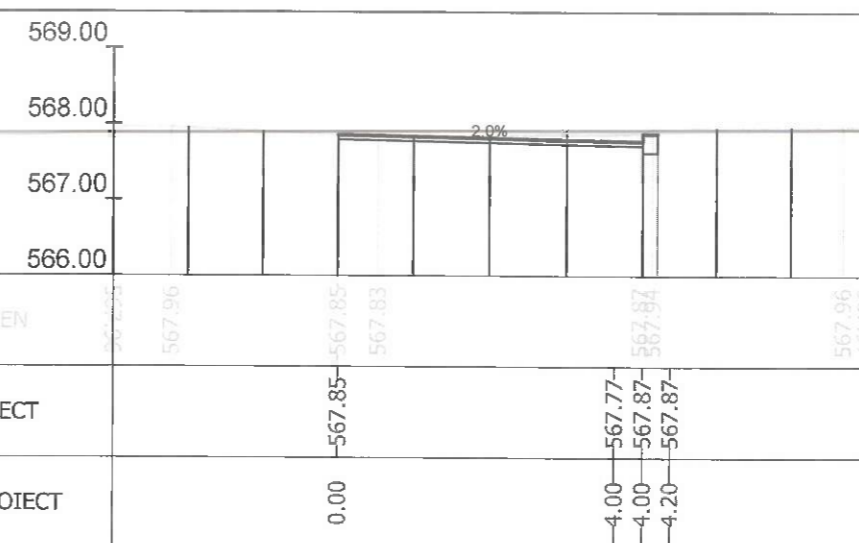
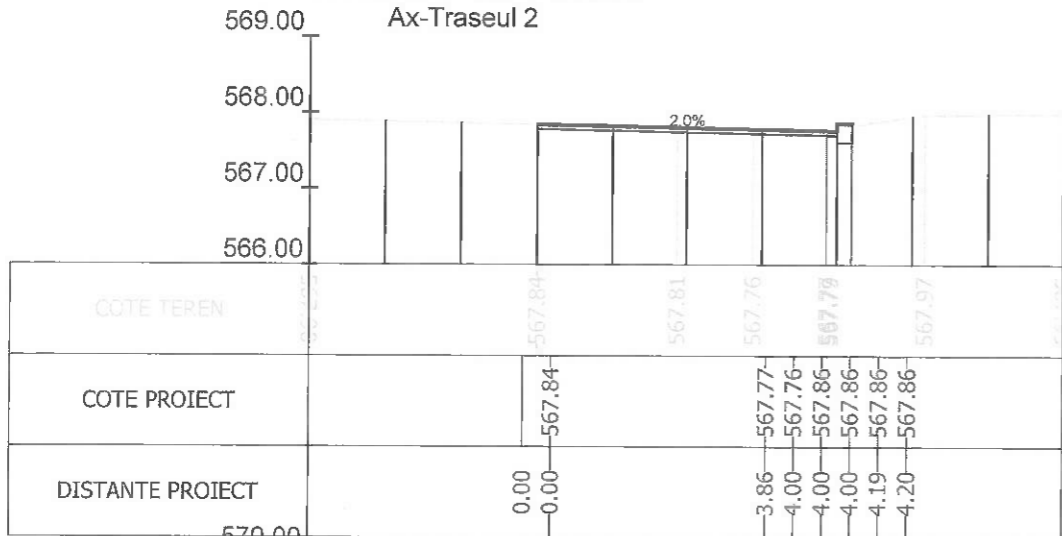

Sectiunea 279 - Km 4+121.505

Ax-Traseul 2

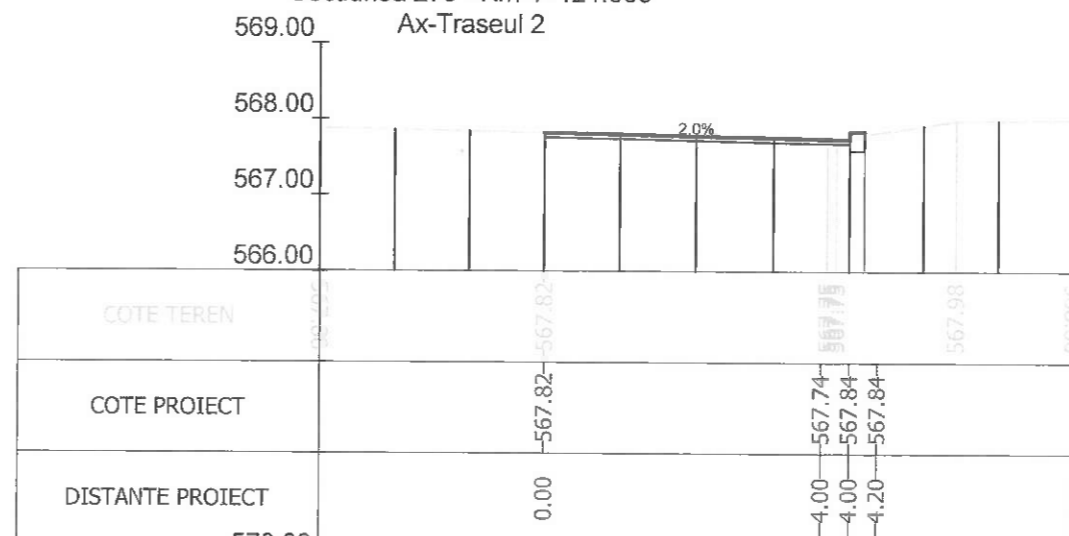

Sectiunea 281 - Km 4+125.916

Ax-Traseul 2

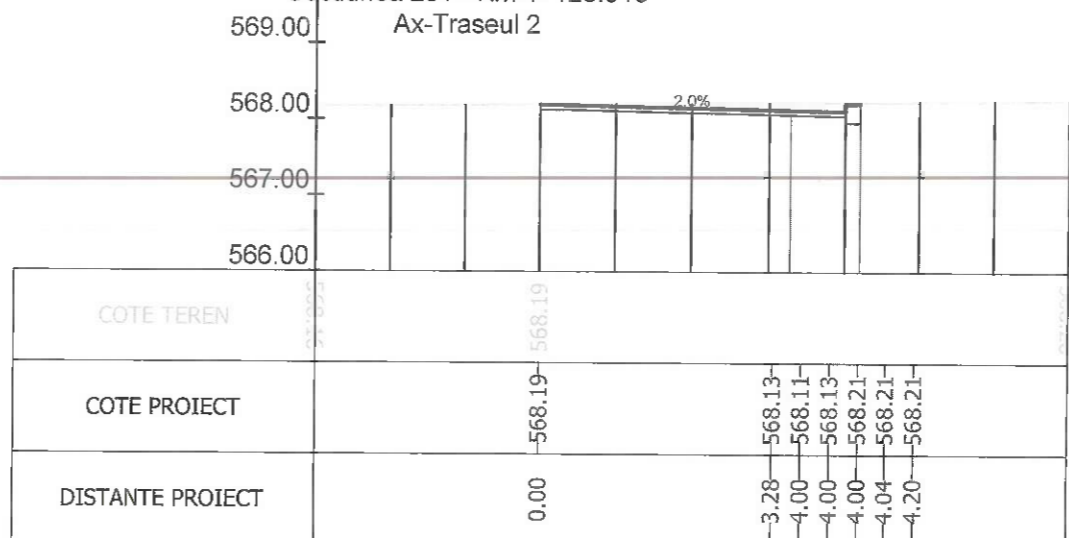

Sectiunea 283 - Km 4+150

Index	Data	Revizii	Rev. 5
A			
		Beneficiar:	MUNICIPIUL BRASOV Bulevardul Eroilor 8, Brasov 500007
Sef Proiect: Ing. A. Buta Proiectat: Ing. A. Buta Desenat: Ing. S. Patroi Verificat:		Titlu proiect:	AMENAJARE BENZI DEDICATE TRANSPORTULUI PUBLIC IN MUNICIPIUL BRASOV SI TROTUARE ADIACENTE
Scara: 1/100 Data: 07/2023		Titlu plansa:	PROFILE TRANSVERSALE CURENTE
		Nr. proiect:	73 / 2020
		Faza:	P.T.
		Nr. plansa:	PT-105

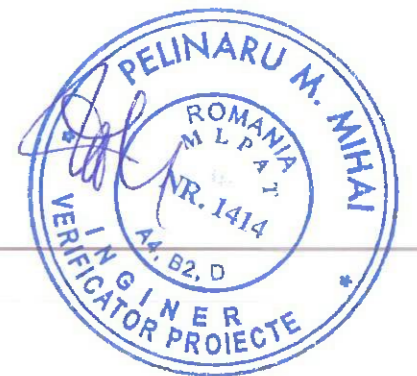

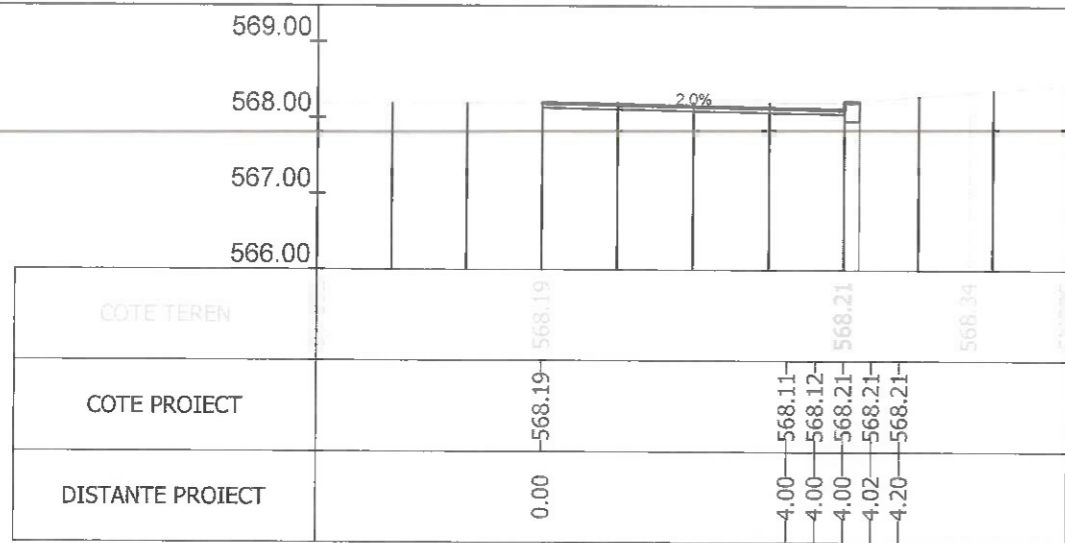

Sectiunea 284 - Km 4+170.989

Ax-Traseul 2

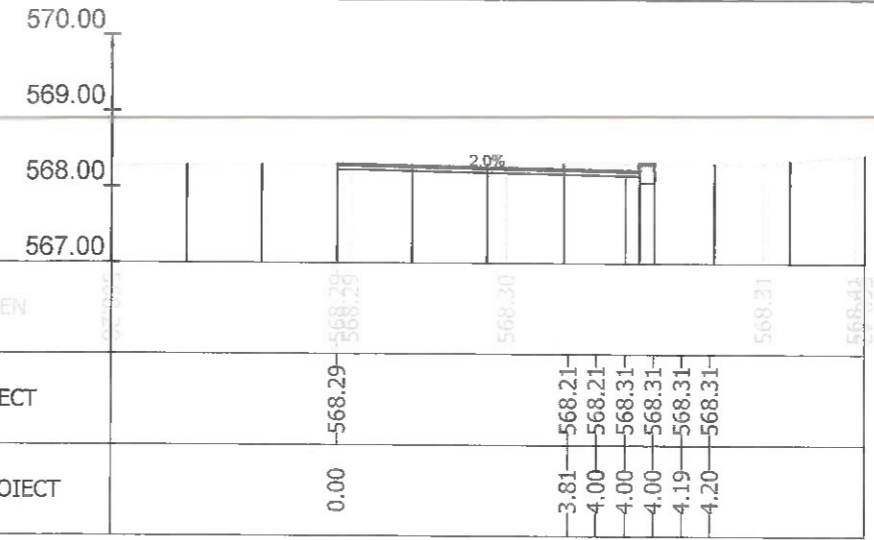
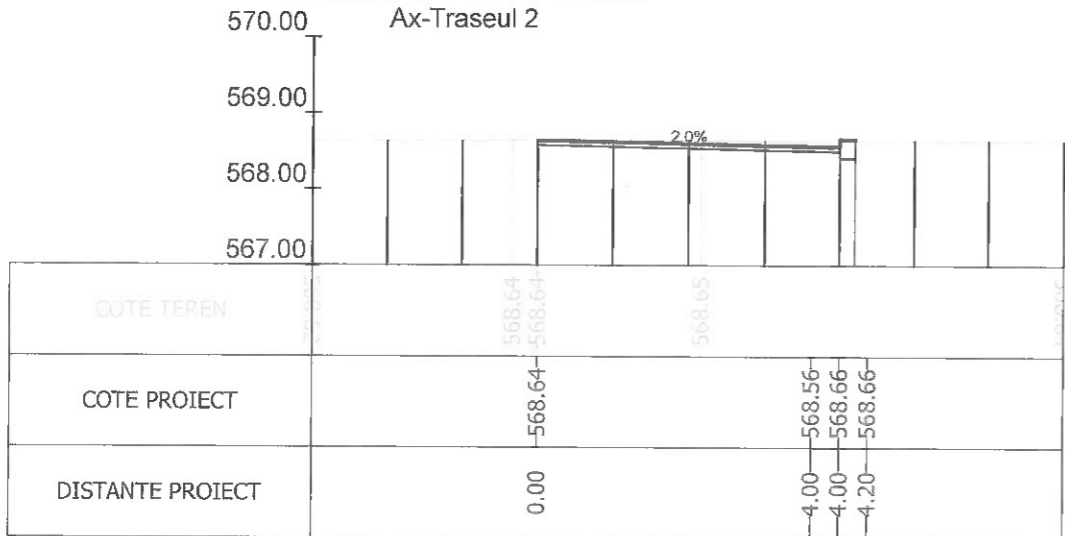

Sectiunea 285 - Km 4+175

Ax-Traseul 2

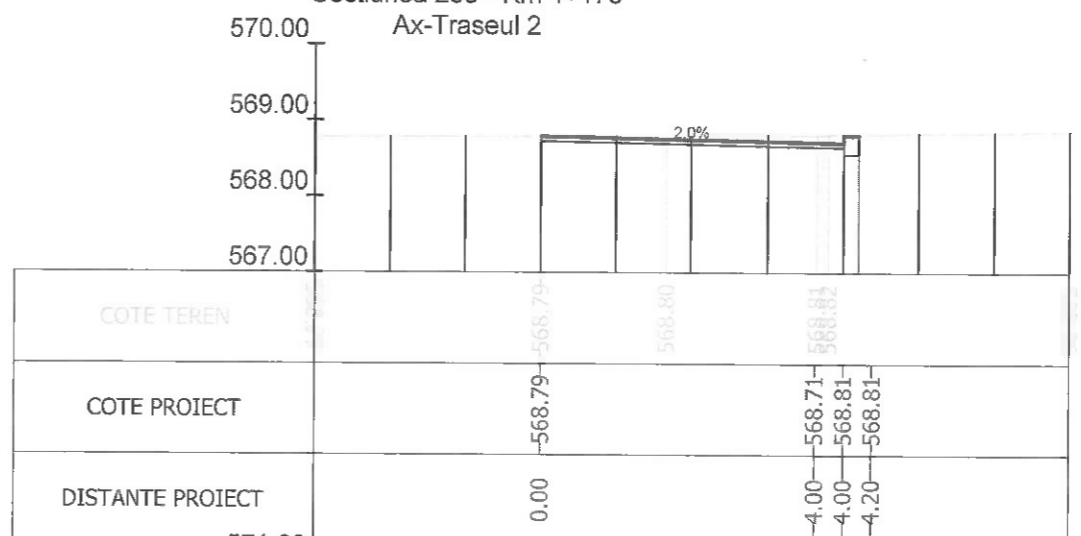

Sectiunea 286 - Km 4+200

Ax-Traseul 2

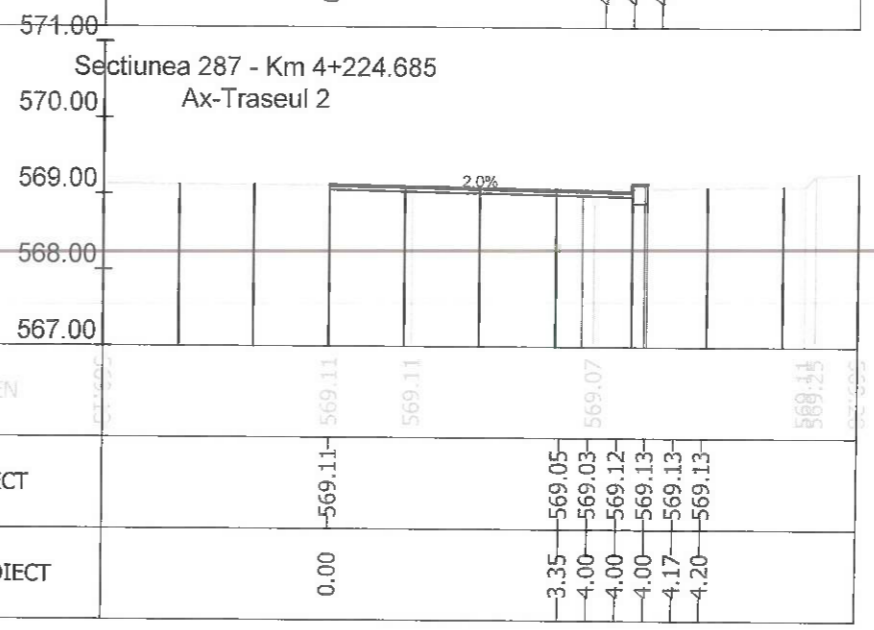

Sectiunea 287 - Km 4+224.685

Ax-Traseul 2

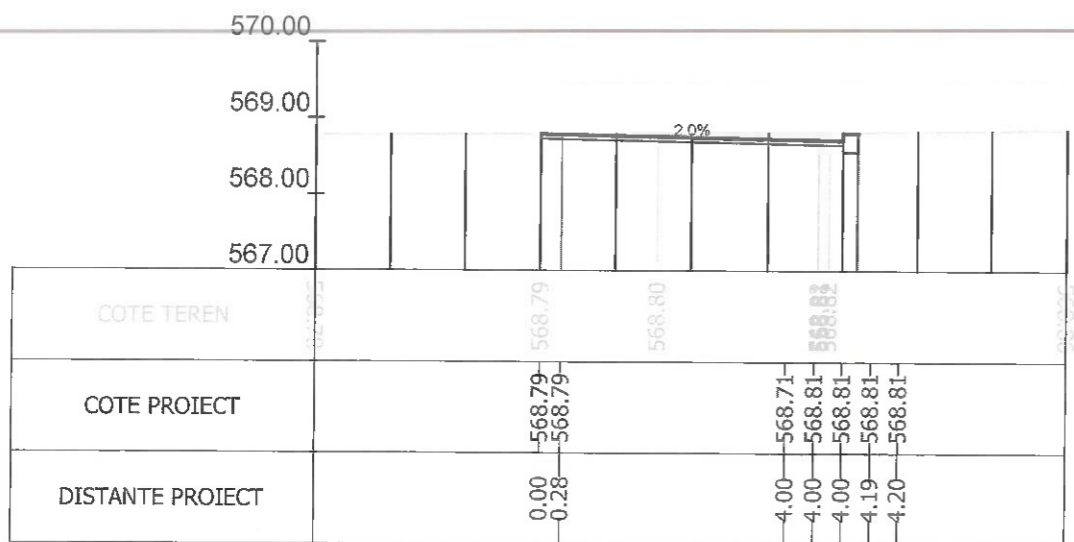
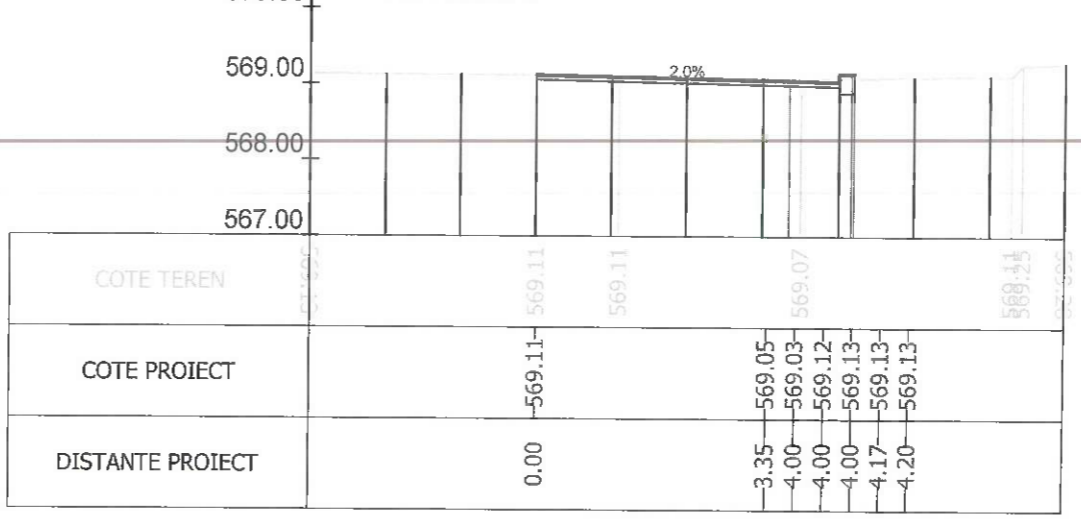

Sectiunea 288 - Km 4+225

Ax-Traseul 2

Sectiunea 289 - Km 4+250

Ax-Traseul 2



Index	A		Rev. 5
			Beneficiar: MUNICIPIUL BRASOV Bulevardul Eroilor 8, Brasov 500007
Sef Proiect	Ing. A. Buta	Scara 1/100	Nr. proiect 73 / 2020
Proiectat	Ing. A. Buta		Faza P.T.
Desenat	Ing. S. Patroi	Data: 07/2023	Nr. plansa PT-106
Verificat			Titlu proiect: AMENAJARE BENZI DEDICATE TRANSPORTULUI PUBLIC IN MUNICIPIUL BRASOV SI TROTUARE ADIACENTE
			Titlu plansa: PROFILE TRANSVERSALE CURENTE

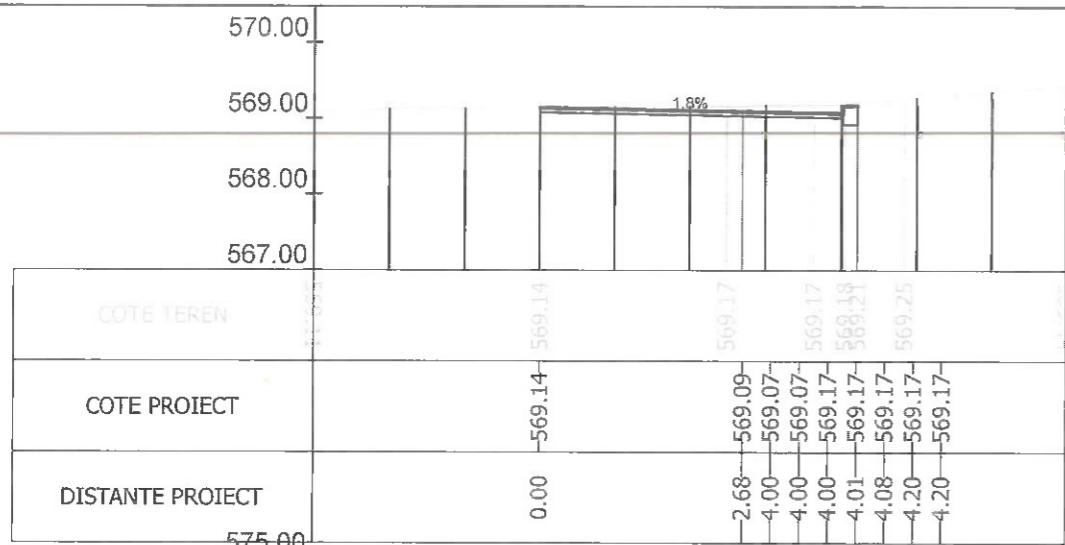

Sectiunea 290 - Km 4+261.284
Ax-Traseul 2

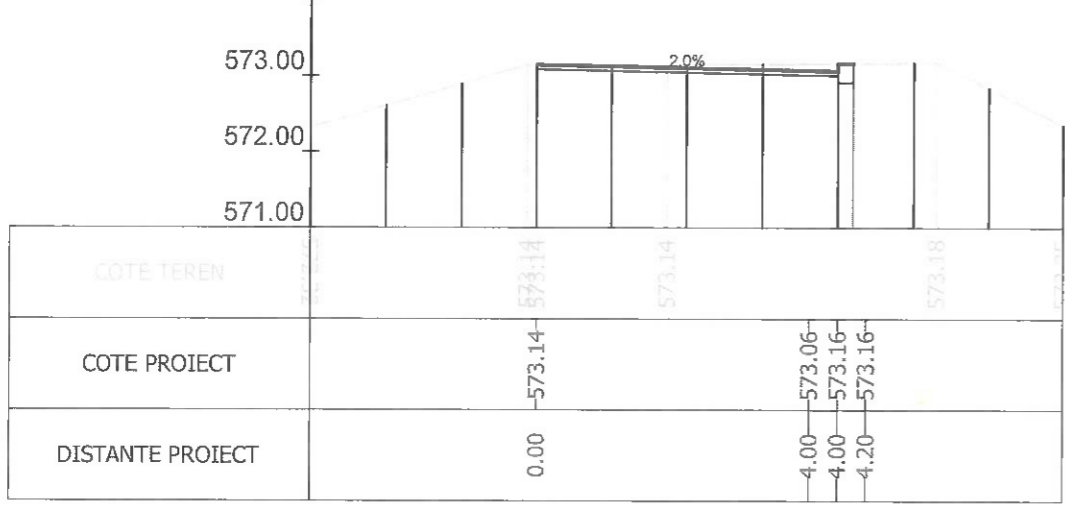

Sectiunea 292 - Km 4+300
Ax-Traseul 2

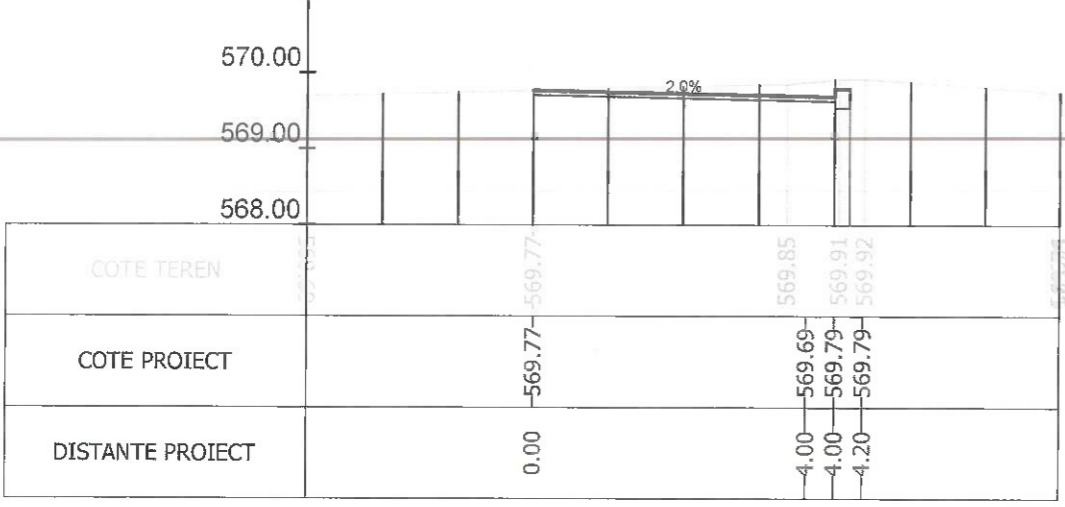

Sectiunea 294 - Km 4+313.052
Ax-Traseul 2

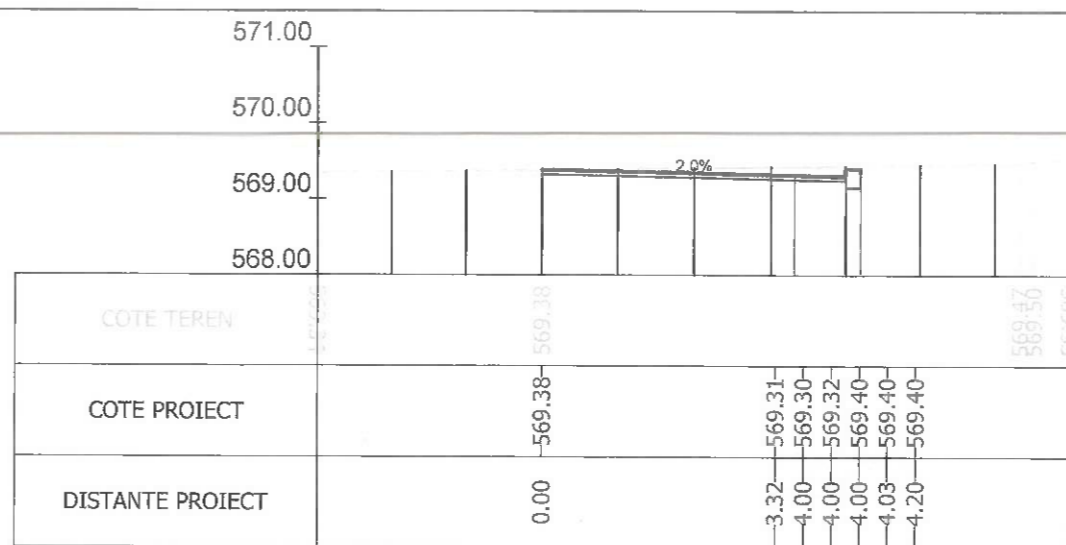

Sectiunea 291 - Km 4+275
Ax-Traseul 2

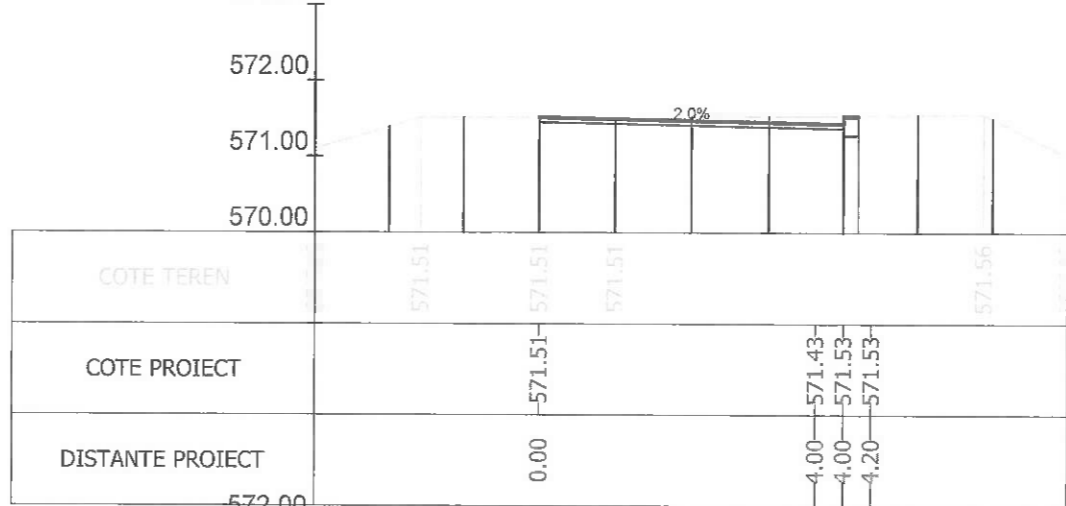

Sectiunea 293 - Km 4+304.835
Ax-Traseul 2

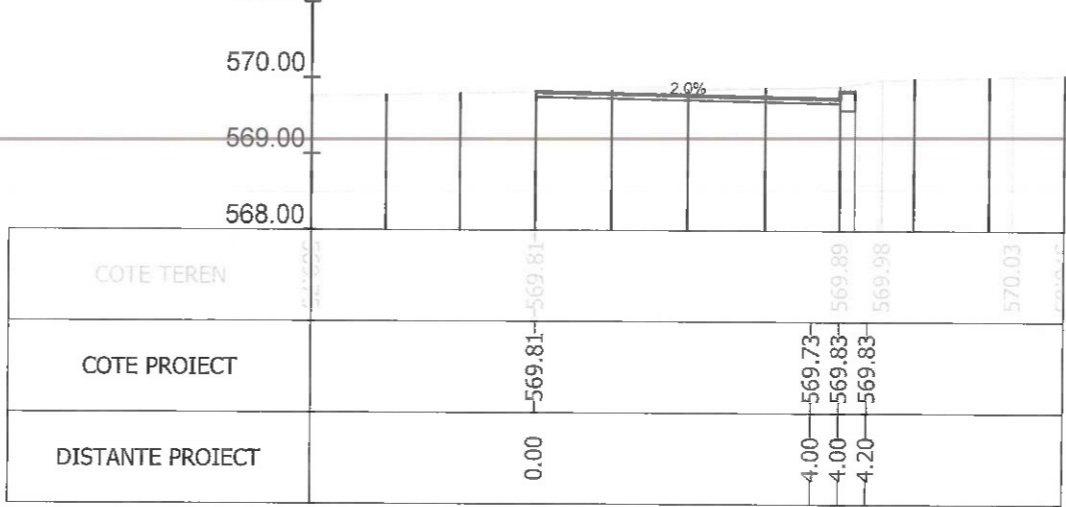

Sectiunea 295 - Km 4+321.270
Ax-Traseul 2



Index	A		Rev. 5
			Beneficiar: MUNICIPIUL BRASOV Bulevardul Eroilor 8, Brasov 500007
Titlu proiect: AMENAJARE BENZI DEDICATE TRANSPORTULUI PUBLIC IN MUNICIPIUL BRASOV SI TROTUARE ADIACENTE			Nr. proiect: 73 / 2020
Titlu plansa: PROFILE TRANSVERSALE CURENTE			Nr. plansa: PT-107
Sef Proiect	Ing. A. Buta	Scara	1/100
Proiectat	Ing. A. Buta	Data	07/2023
Desenat	Ing. S. Patroi		
Verificat			

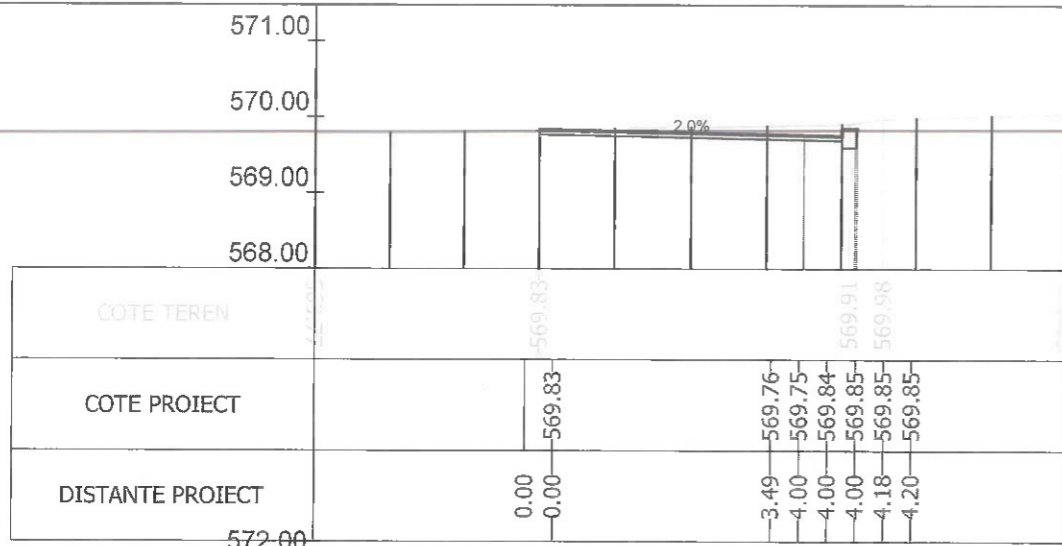

Sectiunea 296 - Km 4+325
Ax-Traseul 2

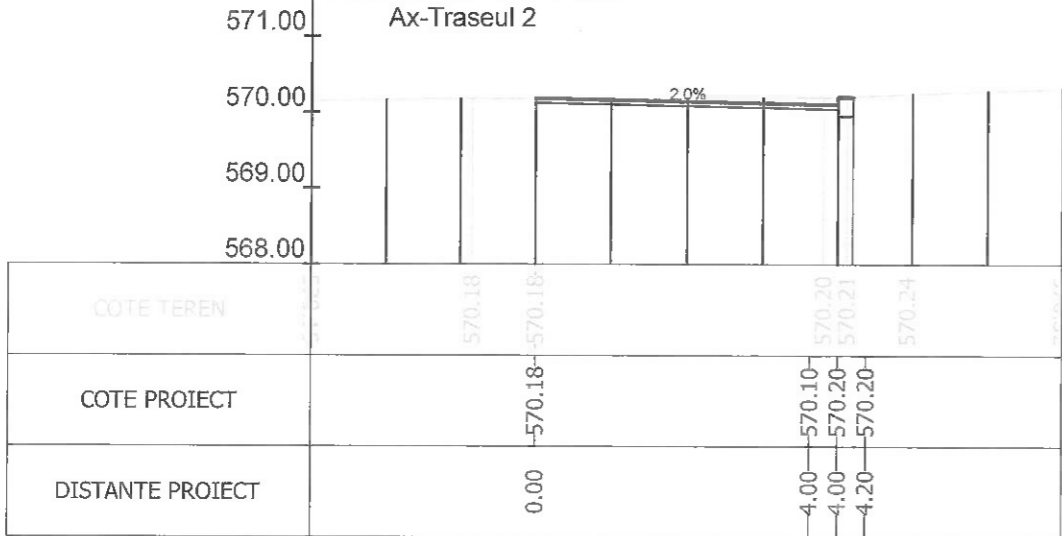

Sectiunea 298 - Km 4+359.832
Ax-Traseul 2

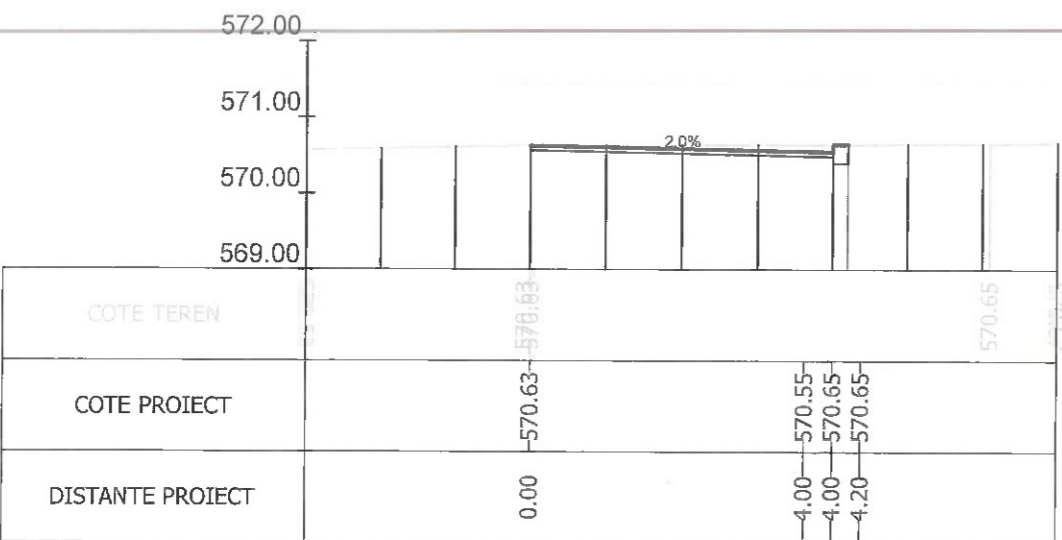

Sectiunea 300 - Km 4+398.395
Ax-Traseul 2

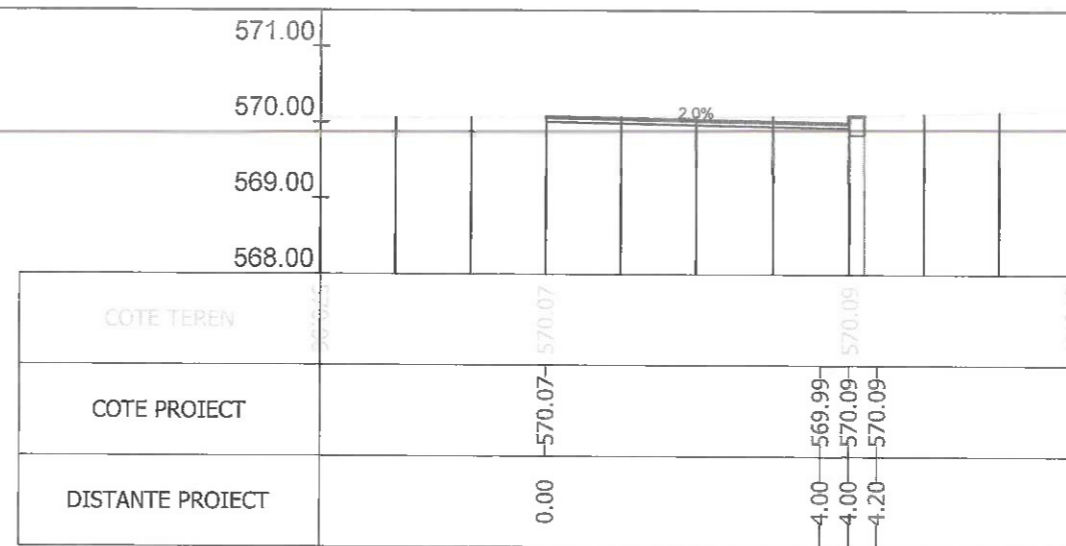

Sectiunea 297 - Km 4+350
Ax-Traseul 2

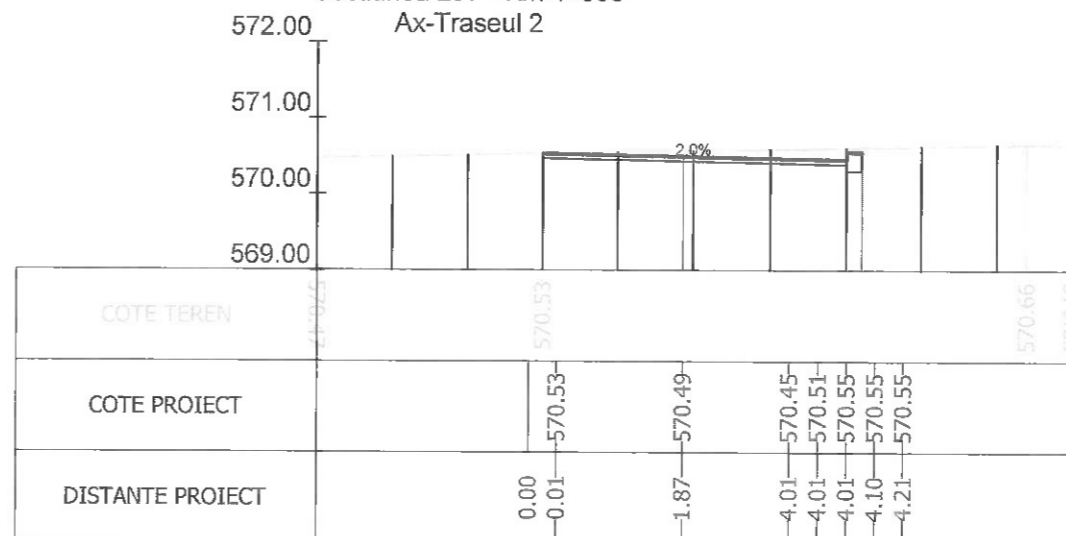

Sectiunea 299 - Km 4+375
Ax-Traseul 2

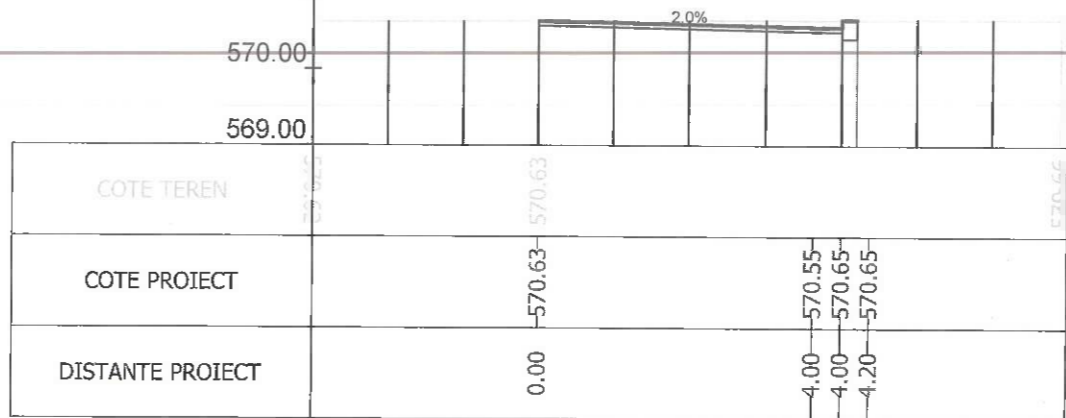

Sectiunea 301 - Km 4+400

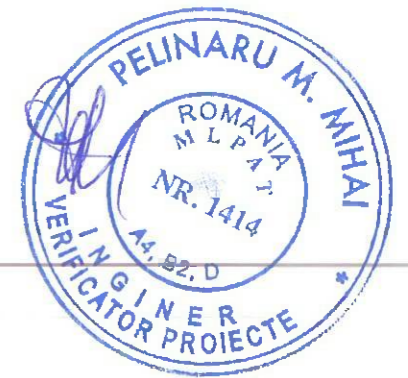

Index	Data	Descriere	Rev. 5
A			
		Beneficiar:	MUNICIPIUL BRASOV Bulevardul Eroilor 8, Brasov 500007
SCS, PONTONARI NR. 17 BLDUL NR. 3 ETAJ 4, VOLUNTARI BUCURESTI, TEL: +40 37 4040440, EMAIL: OFFICE@HENTZA.RO		Titlu proiect:	AMENAJARE BENZI DEDICATE TRANSPORTULUI PUBLIC IN MUNICIPIUL BRASOV SI TROTUARE ADIACENTE
Sef Proiect	Ing. A. Buta	Titlu plansa:	PROFILE TRANSVERSALE CURENTE
Proiectat	Ing. A. Buta		
Desenat	Ing. S. Patroi		
Verificat			
	Scara		Nr. proiect
	1/100		73 / 2020
	Data		Faza
	07/2023		P.T.
			Nr. plansa
			PT-108

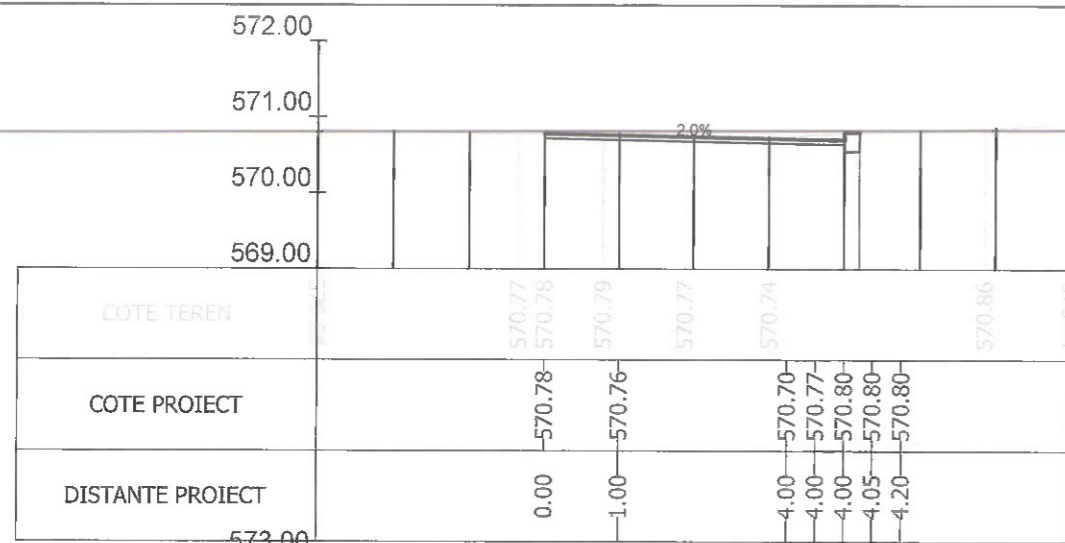

Sectiunea 302 - Km 4+425
Ax-Traseul 2

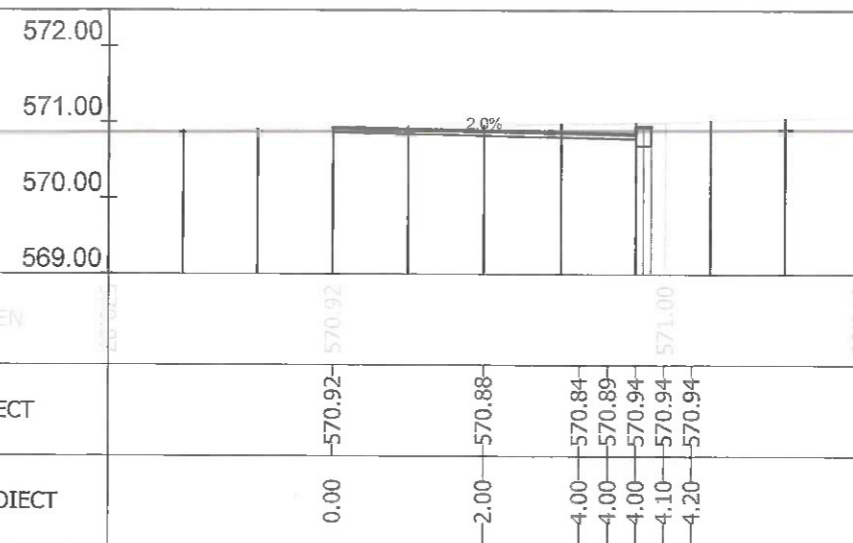
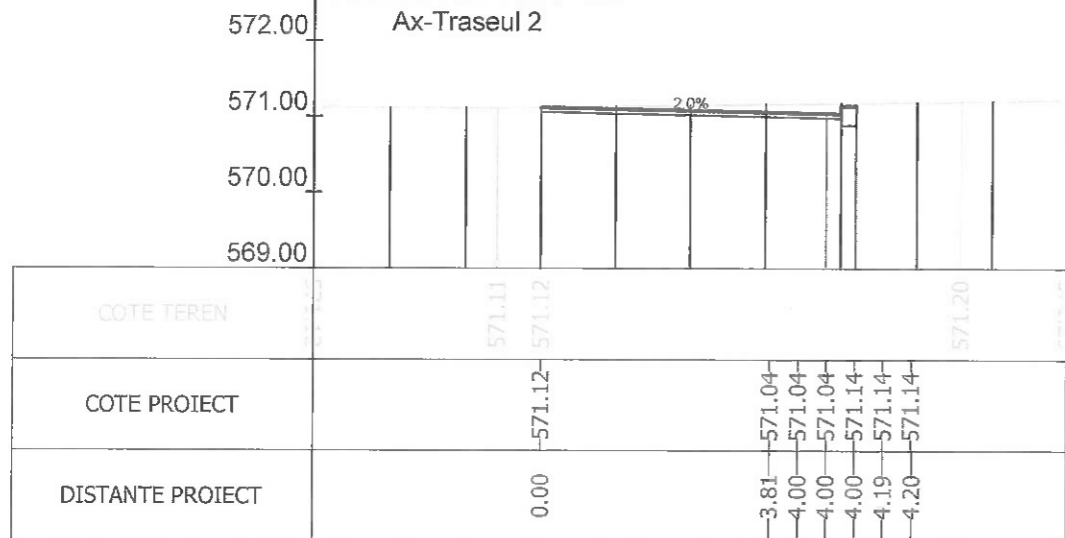

Sectiunea 303 - Km 4+450
Ax-Traseul 2

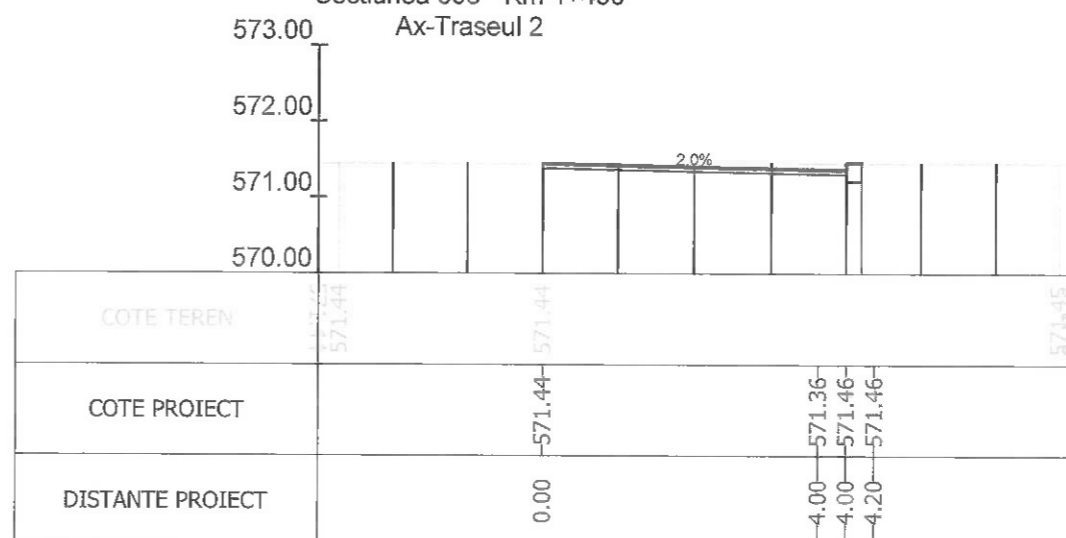

Sectiunea 304 - Km 4+475
Ax-Traseul 2

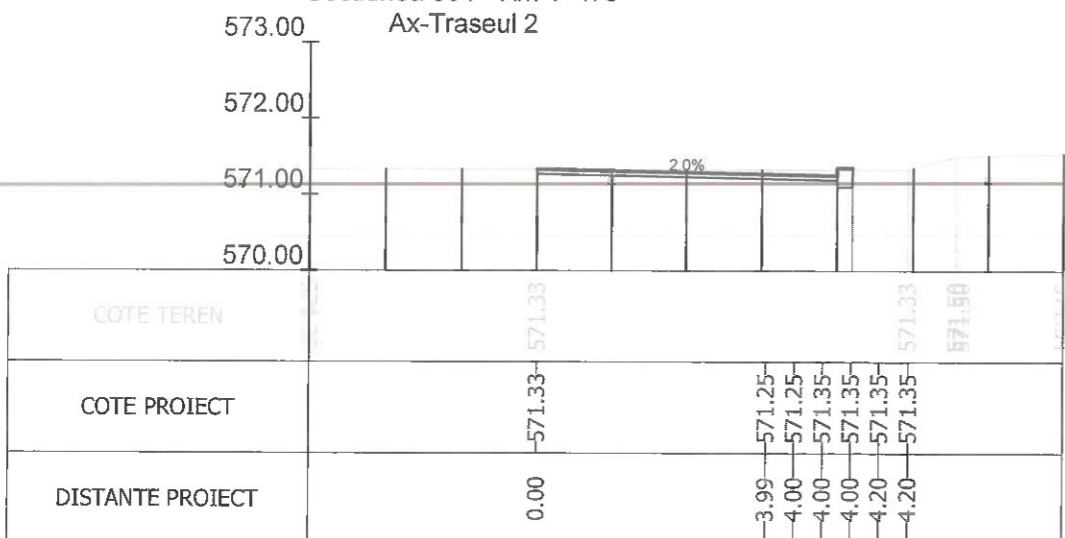

Sectiunea 305 - Km 4+500
Ax-Traseul 2

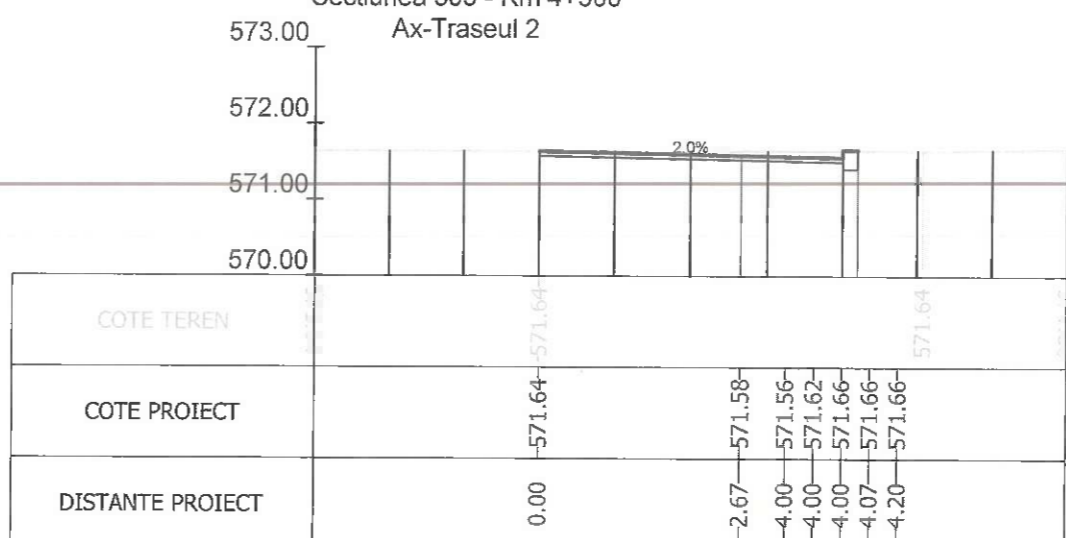

Sectiunea 306 - Km 4+508.474
Ax-Traseul 2

Sectiunea 307 - Km 4+525
Ax-Traseul 2



Index	A		Rev. 5
Beneficiar:	MUNICIPIUL BRASOV Bulevardul Eroilor 8, Brasov 500007		Nr. proiect 73 / 2020
Titlu proiect:	AMENAJARE BENZI DEDICATE TRANSPORTULUI PUBLIC IN MUNICIPIUL BRASOV SI TROTUARE ADIACENTE		Faza P.T.
Titlu plansa:	PROFILE TRANSVERSALE CURENTE		Nr. plansa PT-109
Sef Proiect	Ing. A. Buta	Scara	
Proiectat	Ing. A. Buta	1/100	
Desenat	Ing. S. Patroi	Data	
Verificat		07/2023	

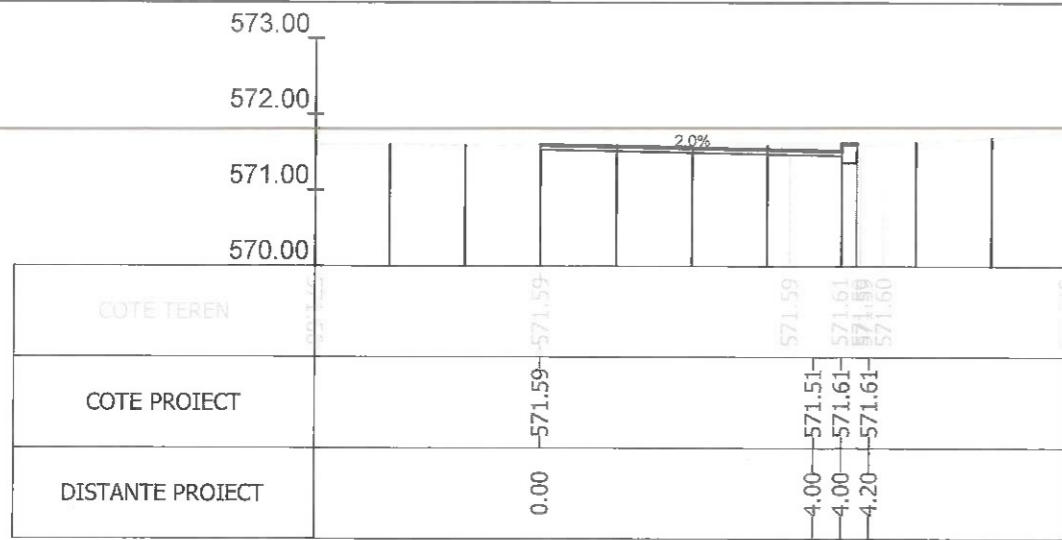

Sectiunea 308 - Km 4+542.260

Ax-Traseul 2

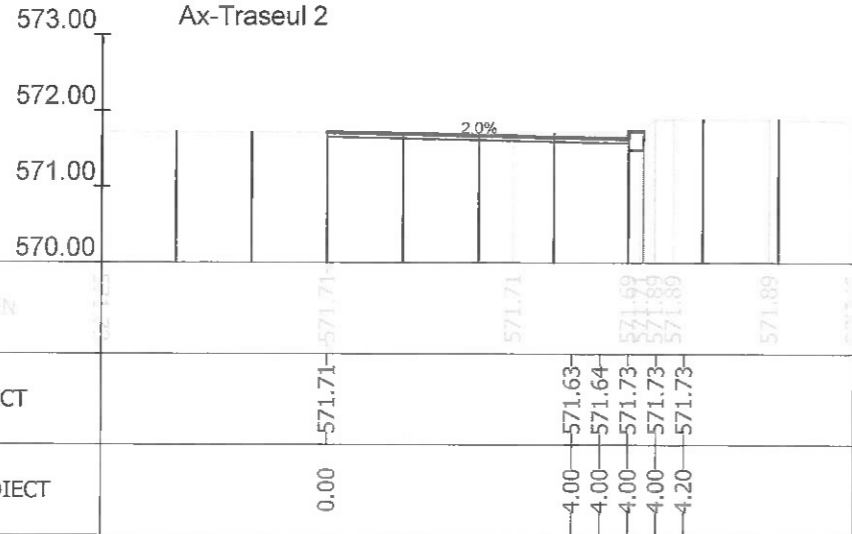

Sectiunea 310 - Km 4+556.043

Ax-Traseul 2

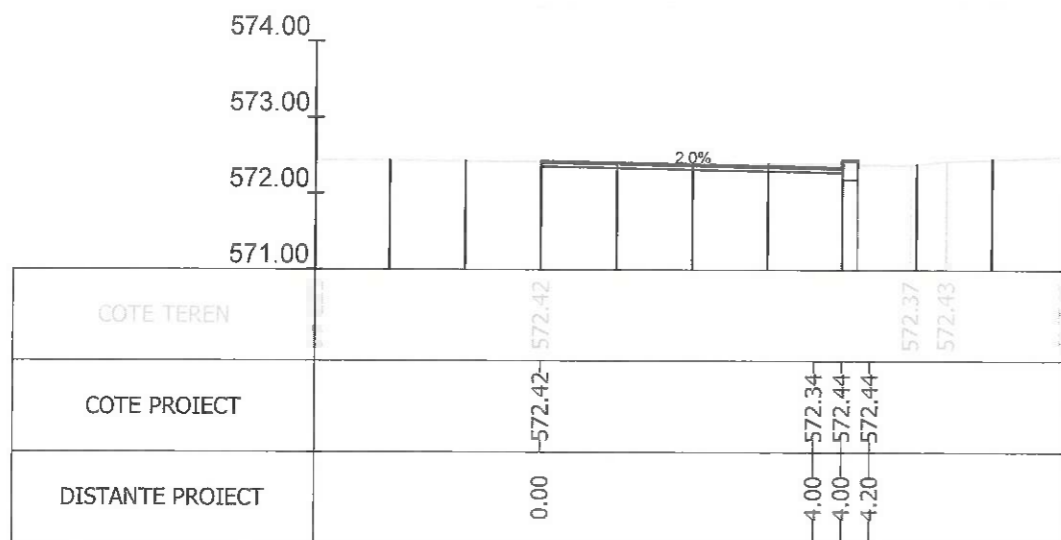

Sectiunea 312 - Km 4+597.927

Ax-Traseul 2

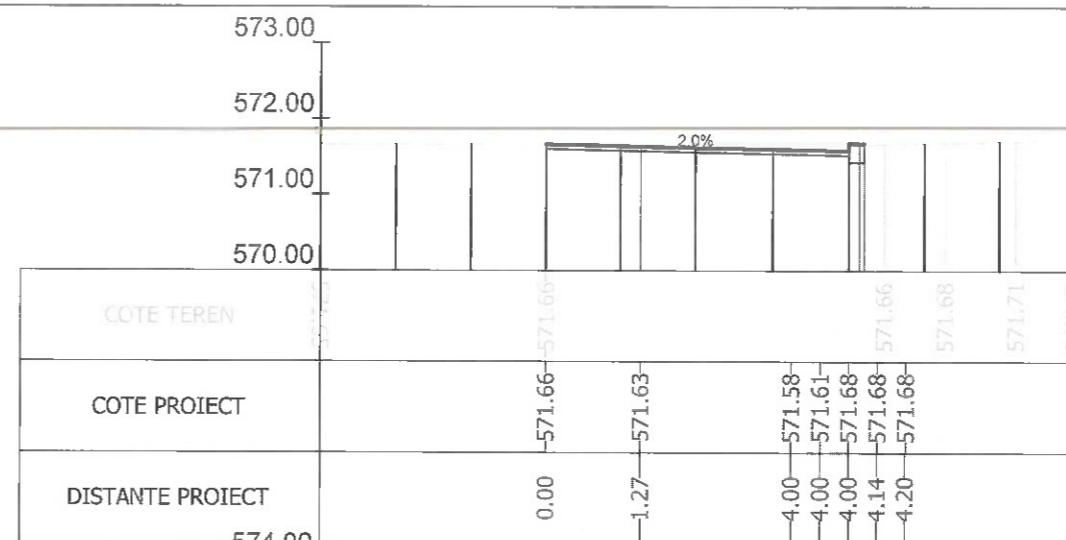

Sectiunea 309 - Km 4+550

Ax-Traseul 2

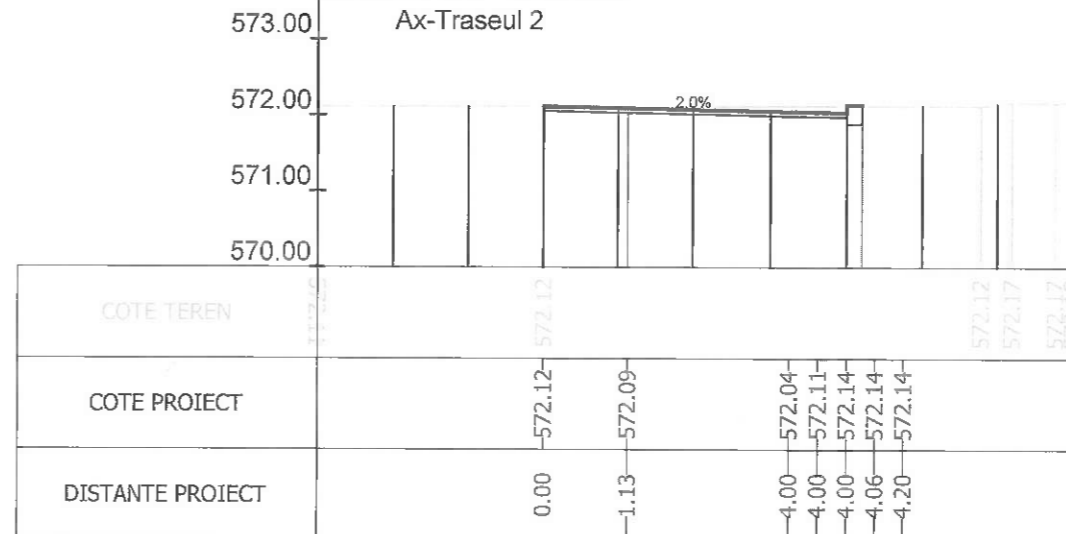

Sectiunea 311 - Km 4+575

Ax-Traseul 2

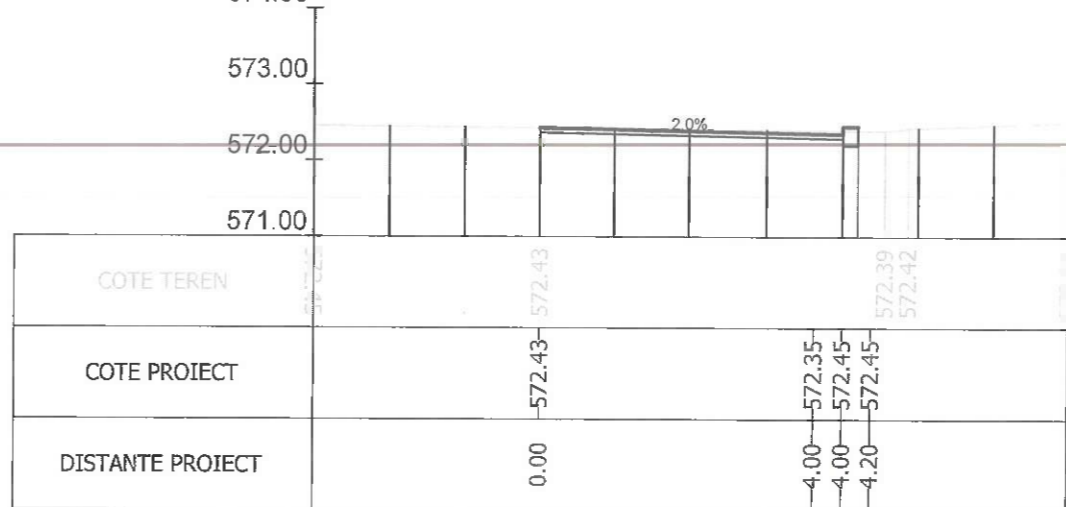

Sectiunea 313 - Km 4+600

Ax-Traseul 2



Index	A		Rev. 5
			Beneficiar: MUNICIPIUL BRASOV Bulevardul Eroilor 8, Brasov 500007
Sef Proiect: Ing. A. Buta Proiectat: Ing. A. Buta Desenat: Ing. S. Patroi Verificat:			Nr. proiect: 73 / 2020 Faza: P.T. Nr. plansa: PT-110
Scara: 1/100 Data: 07/2023			Titlu proiect: AMENAJARE BENZI DEDICATE TRANSPORTULUI PUBLIC IN MUNICIPIUL BRASOV SI TROTUARE ADIACENTE Titlu plansa: PROFILE TRANSVERSALE CURENTE

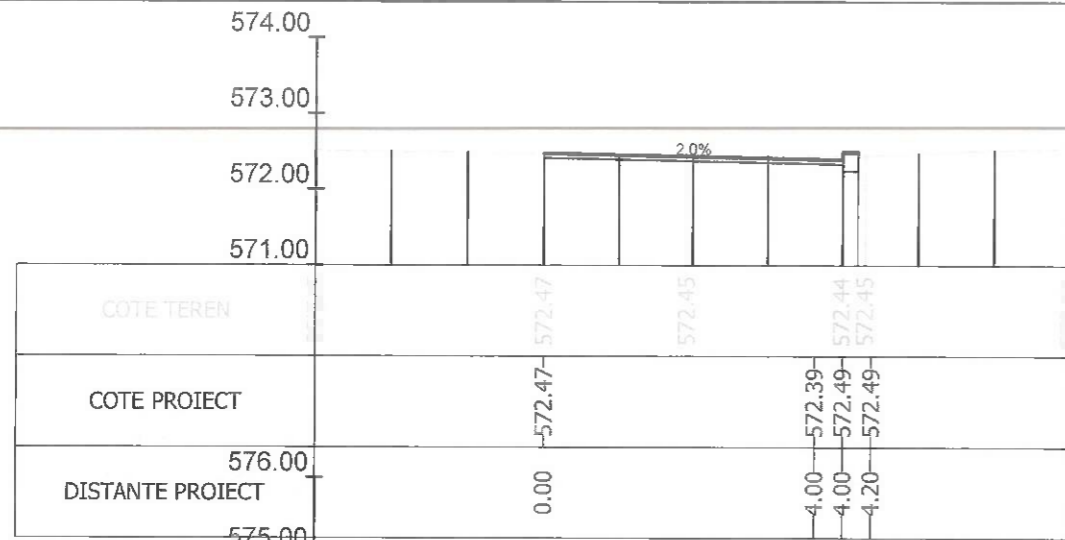

Sectiunea 314 - Km 4+604.290
Ax-Traseul 2

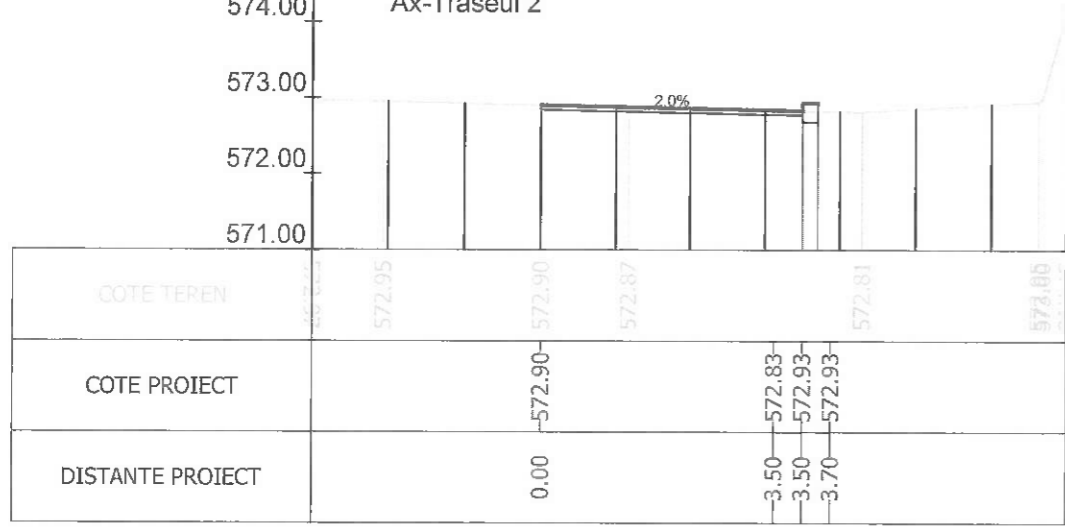

Sectiunea 318 - Km 4+629.848
Ax-Traseul 2

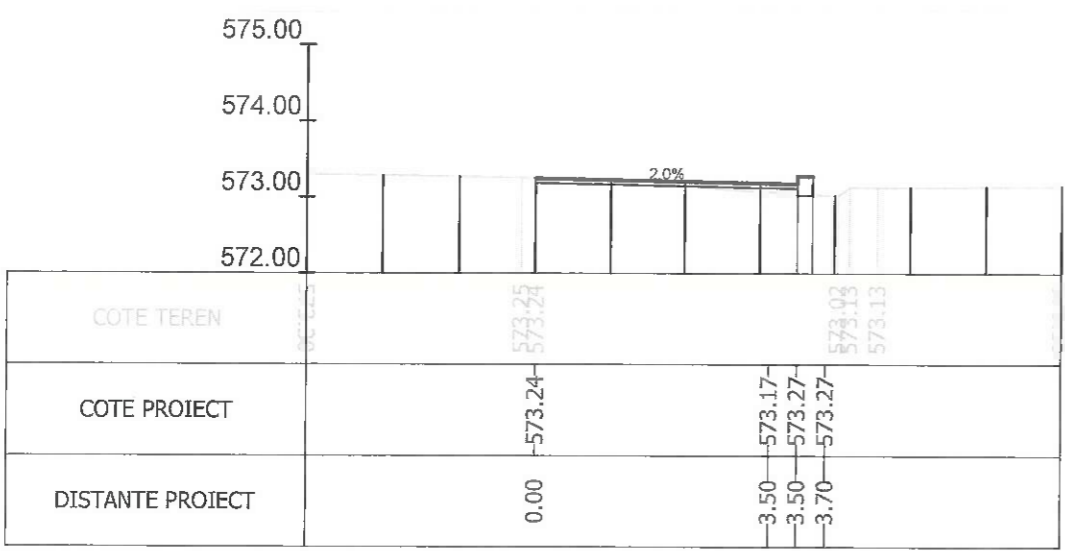

Sectiunea 320 - Km 4+637.944
Ax-Traseul 2

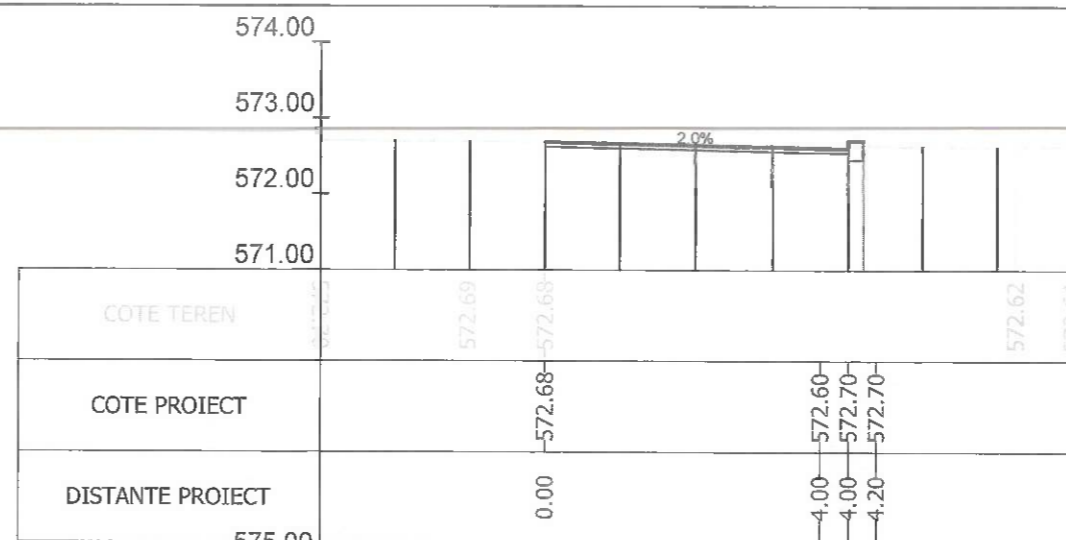

Sectiunea 315 - Km 4+610.652
Ax-Traseul 2

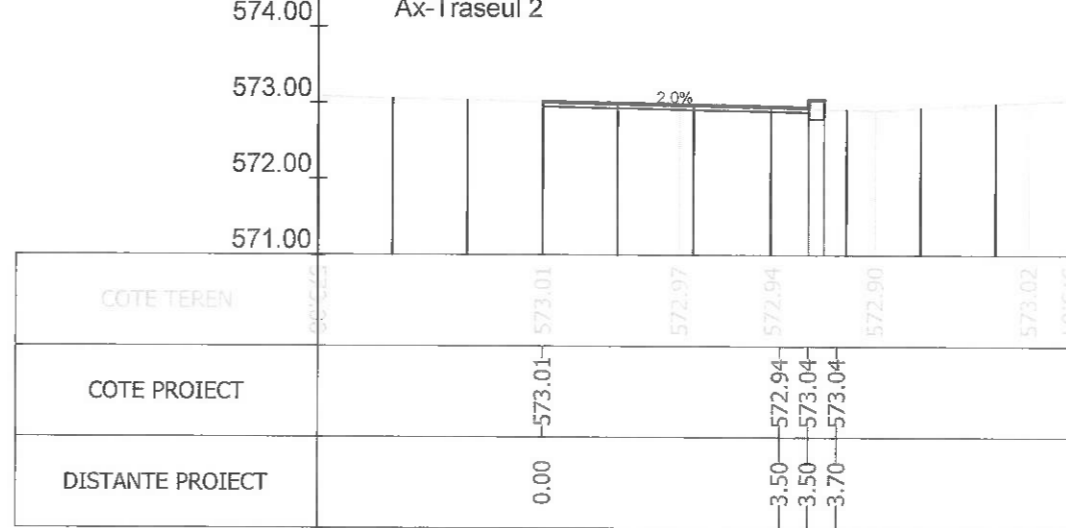

Sectiunea 319 - Km 4+633.896
Ax-Traseul 2

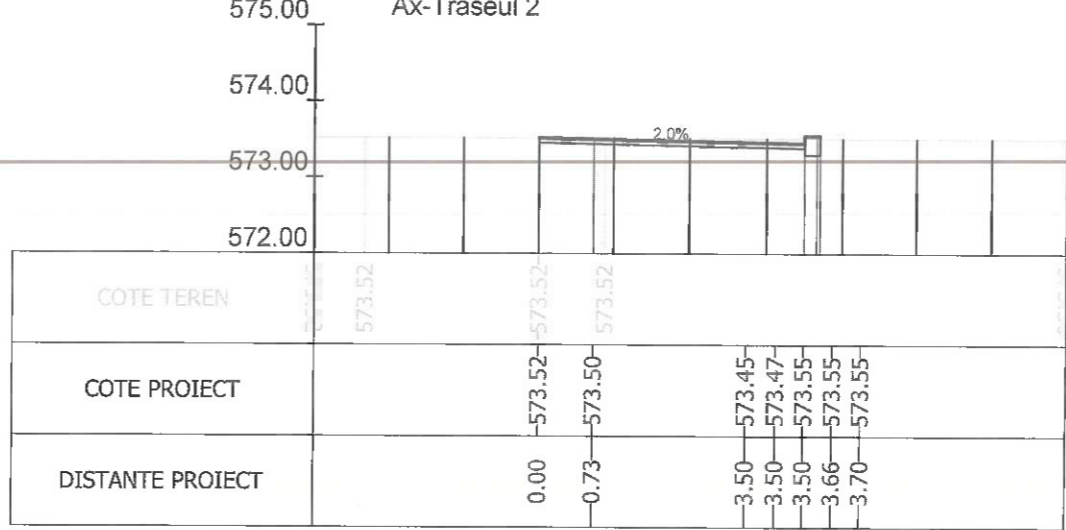

Sectiunea 321 - Km 4+650
Ax-Traseul 2

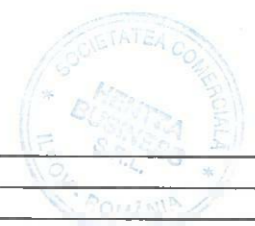

Index	A		Rev. 5
			Beneficiar: MUNICIPIUL BRASOV Bulevardul Eroilor 8, Brasov 500007
Scara: 1/100 Data: 07/2023			Nr. proiect: 73 / 2020
Titlu proiect: AMENAJARE BENZI DEDICATE TRANSPORTULUI PUBLIC IN MUNICIPIUL BRASOV SI TROTUARE ADIACENTE			Faza P.T.
Titlu plansa: PROFILE TRANSVERSALE CURENTE			Nr. plansa PT-111
Sef Proiect	Ing. A. Buta		
Proiectat	Ing. A. Buta		
Desenat	Ing. S. Patroi		
Verificat			

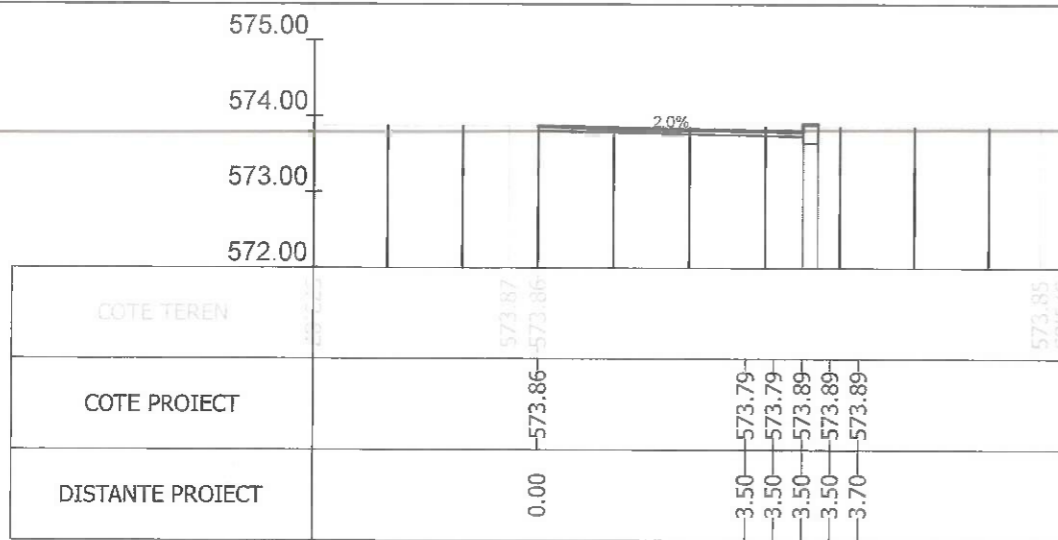

Sectiunea 322 - Km 4+662.054

Ax-Traseul 2

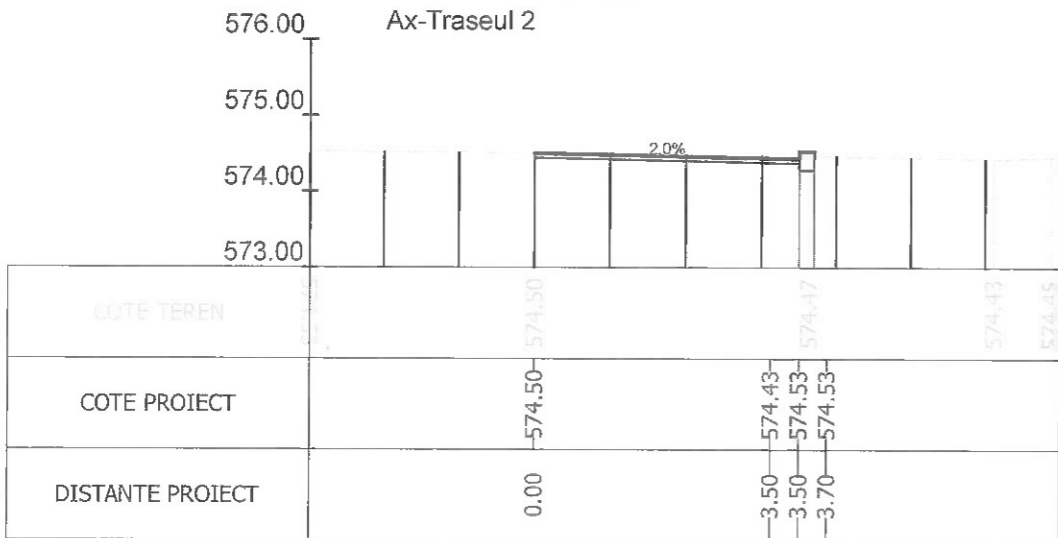

Sectiunea 323 - Km 4+675

Ax-Traseul 2

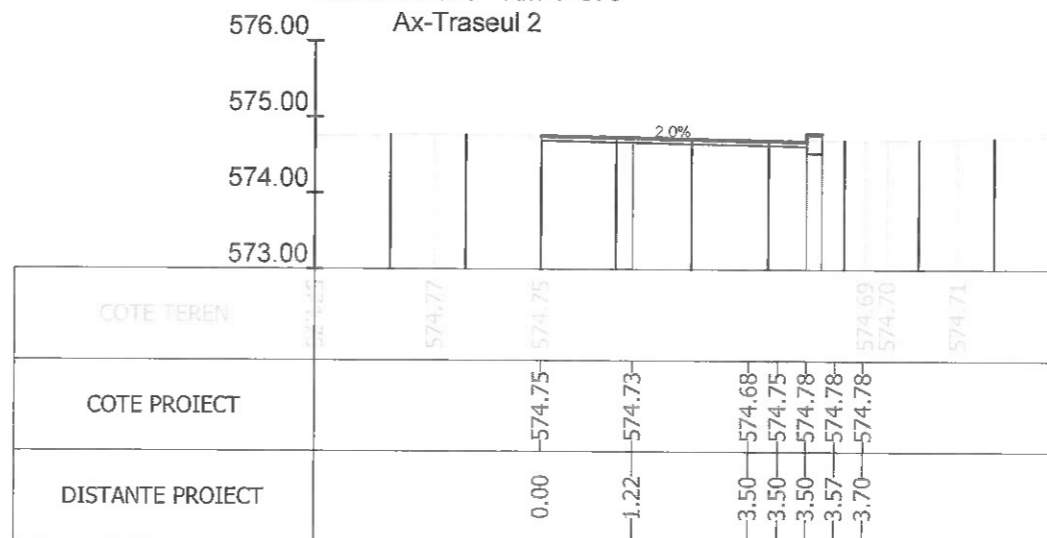

Sectiunea 324 - Km 4+700

Ax-Traseul 2

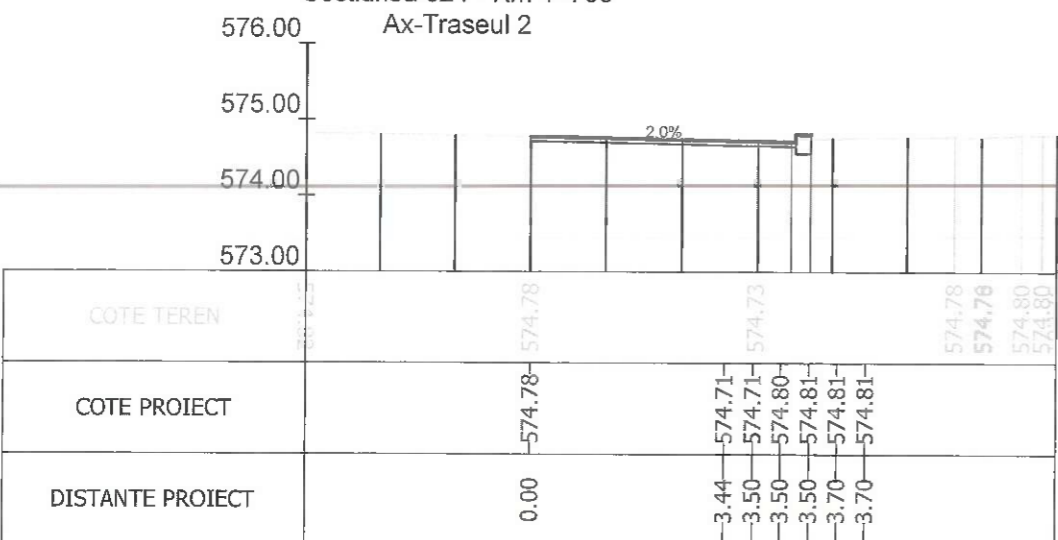

Sectiunea 325 - Km 4+725

Ax-Traseul 2

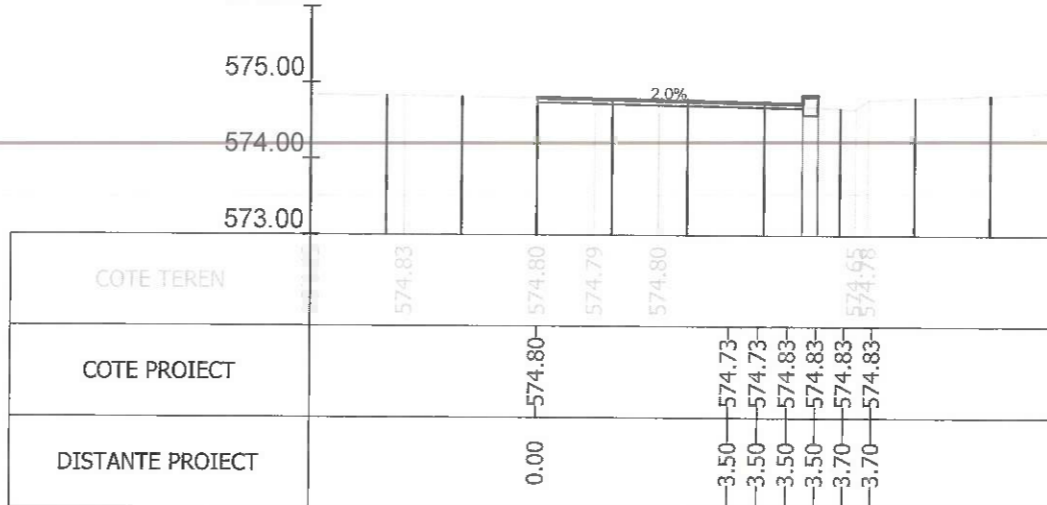

Sectiunea 326 - Km 4+729.059

Ax-Traseul 2

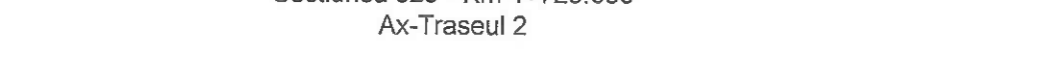

Sectiunea 327 - Km 4+734.073

Ax-Traseul 2



Index	Data	Observatii	Rev. 5
A			
		Beneficiar:	MUNICIPIUL BRASOV Bulevardul Eroilor 8, Brasov 500007
Sef Proiect: Ing. A. Buta Proiectat: Ing. A. Buta Desenat: Ing. S. Patroi Verificat:		Nr. proiect:	73 / 2020
Scara: 1/100 Data: 07/2023		Faza:	P.T.
		Nr. plansa:	PT-112
		Titlu proiect: AMENAJARE BENZI DEDICATE TRANSPORTULUI PUBLIC IN MUNICIPIUL BRASOV SI TROTUARE ADIACENTE	
		Titlu plansa: PROFILE TRANSVERSALE CURENTE	

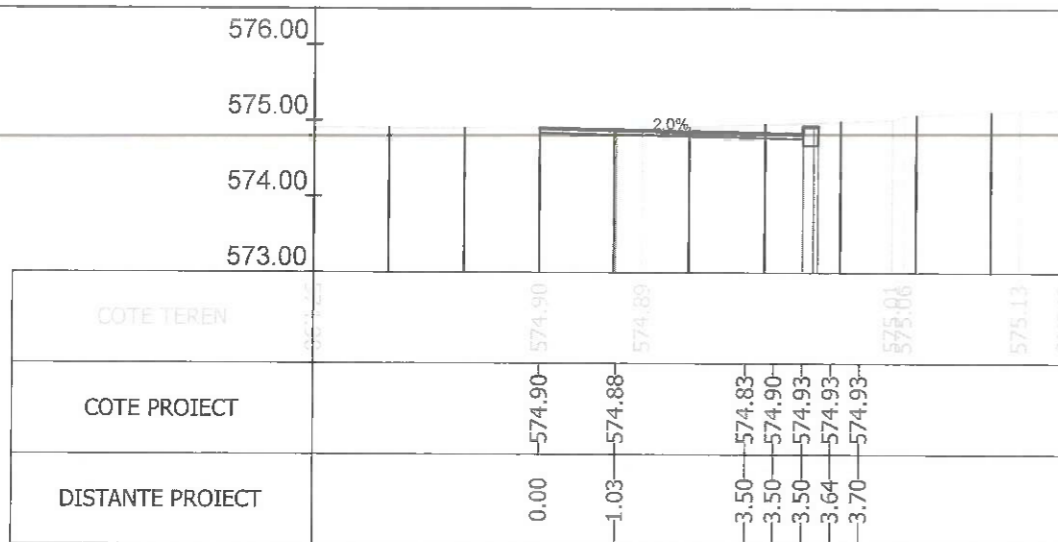

Sectiunea 328 - Km 4+750

Ax-Traseul 2

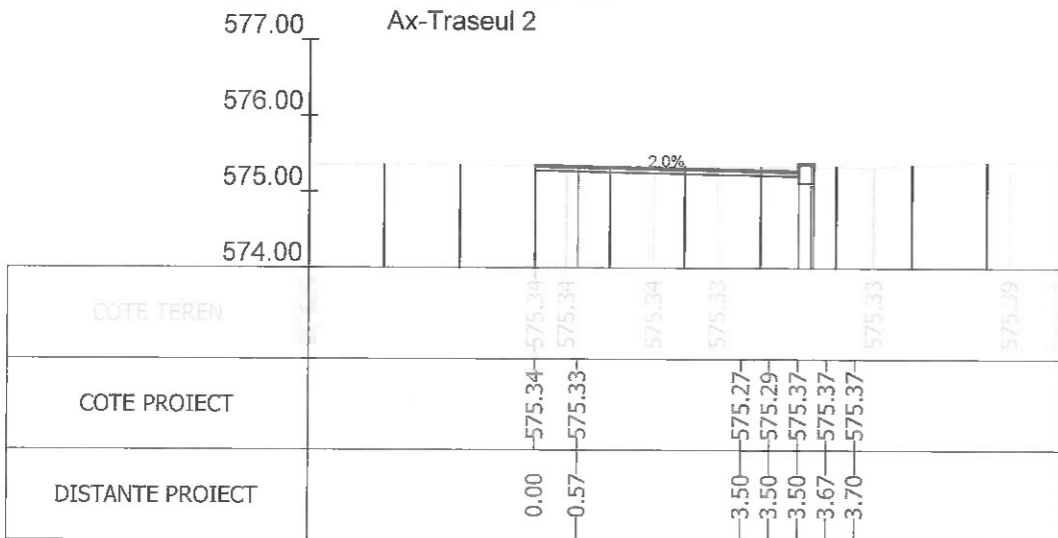

Sectiunea 329 - Km 4+752.969

Ax-Traseul 2

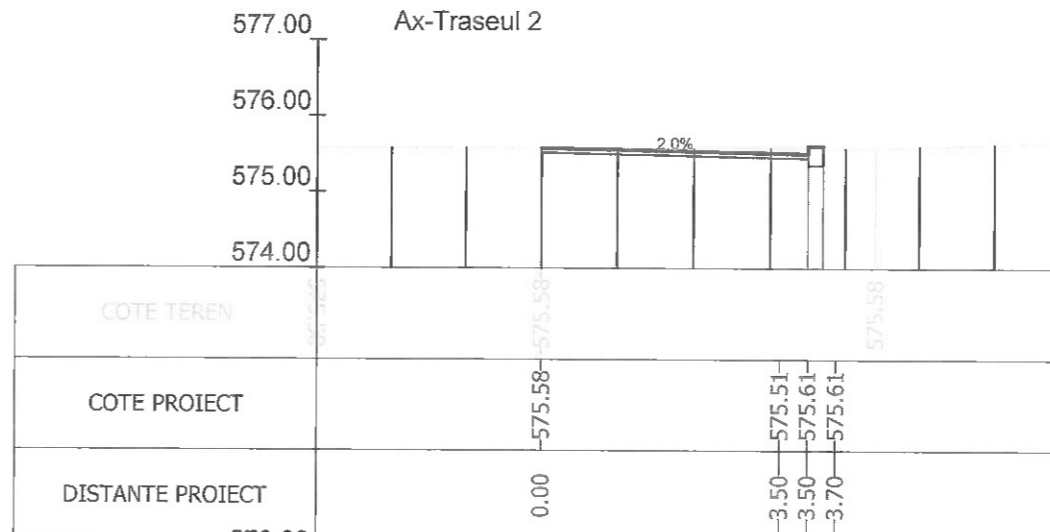

Sectiunea 330 - Km 4+775

Ax-Traseul 2

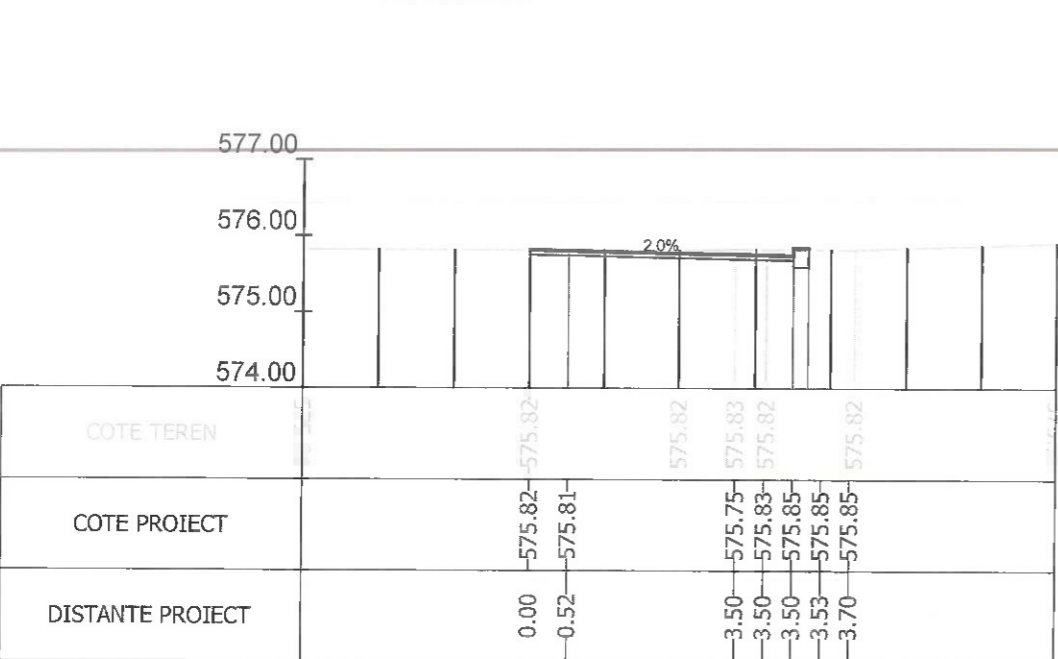

Sectiunea 331 - Km 4+800

Ax-Traseul 2

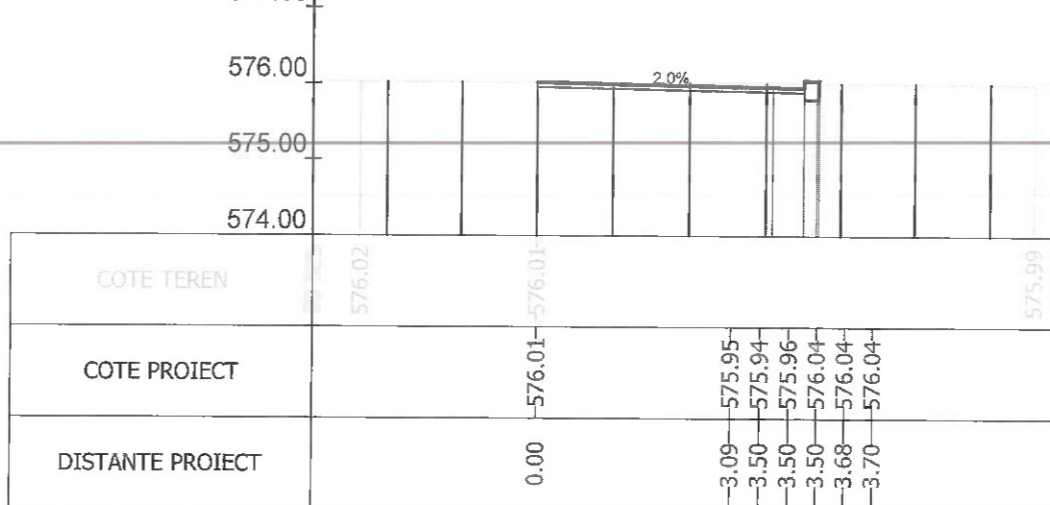

Sectiunea 332 - Km 4+825

Ax-Traseul 2



Sectiunea 333 - Km 4+850

Index	Data	Rev.
A		5

	Beneficiar:	MUNICIPIUL BRASOV Bulevardul Eroilor 8, Brasov 500007	Nr. proiect 73 / 2020
	Titlu proiect:	AMENAJARE BENZI DEDICATE TRANSPORTULUI PUBLIC IN MUNICIPIUL BRASOV SI TROTUARE ADIACENTE	Faza P.T.
Sef Proiect Ing. A. Buta Proiectat Ing. A. Buta Desenat Ing. S. Patroi Verificat	Scara 1/100 Data 07/2023	Titlu plansa: PROFILE TRANSVERSALE CURENTE	Nr. plansa PT-113



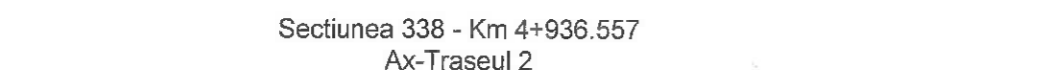
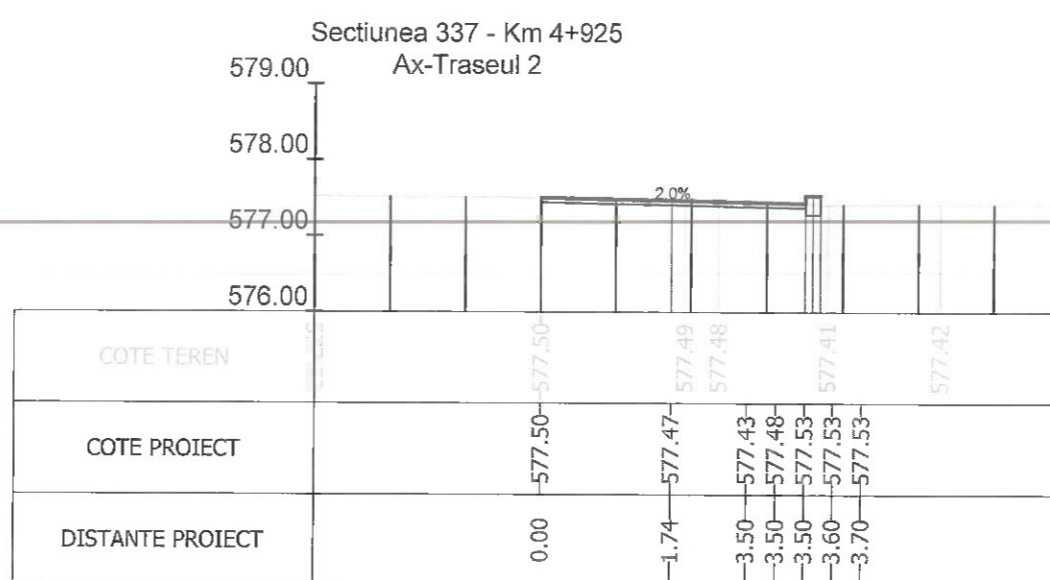
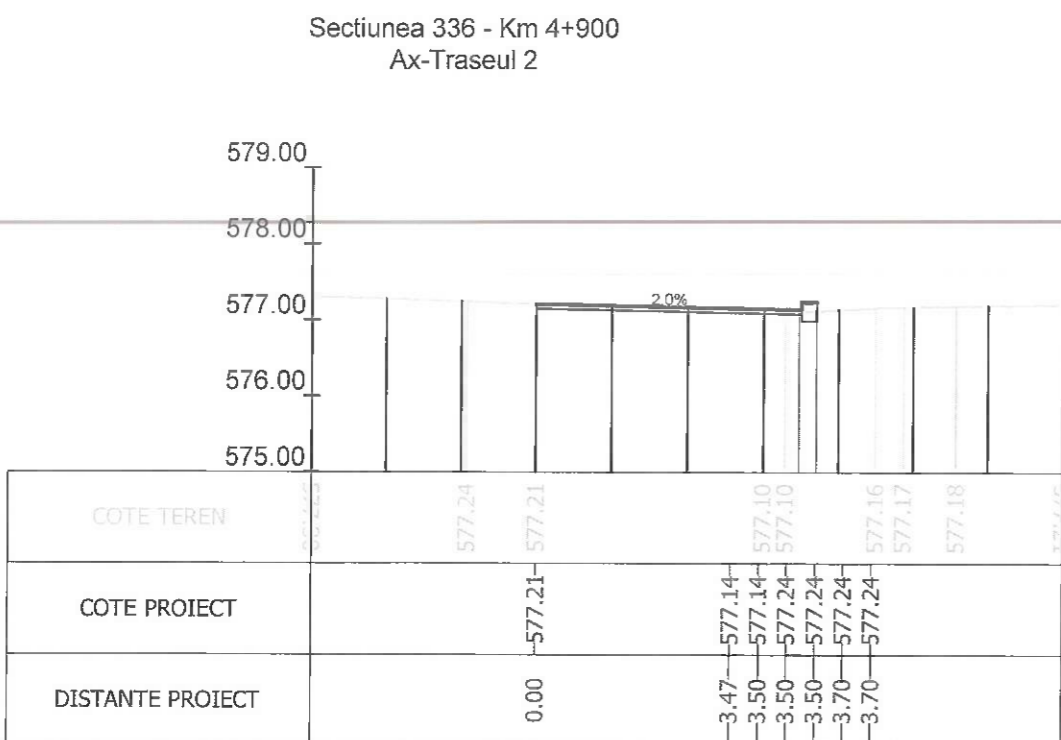
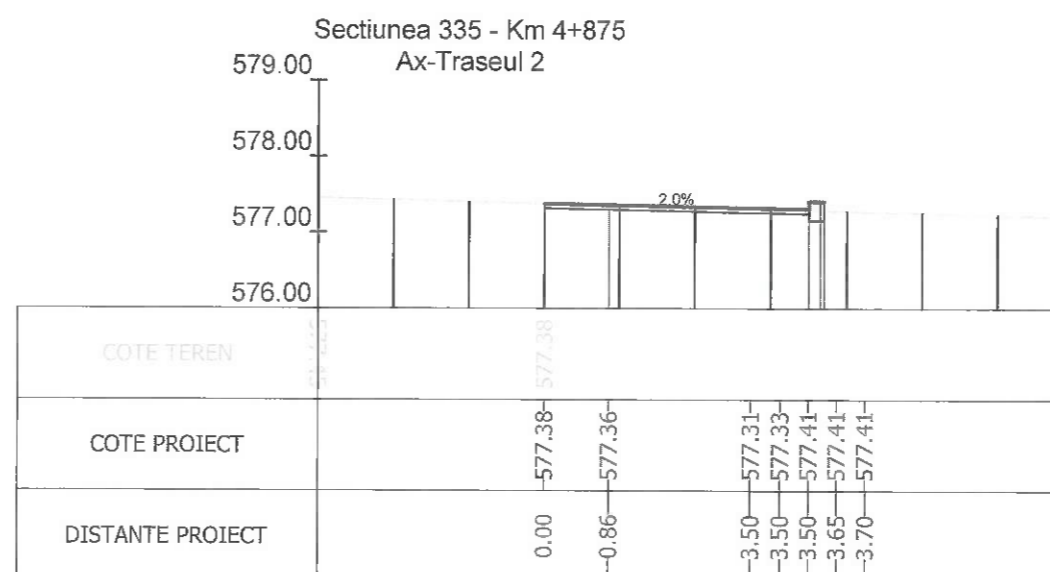
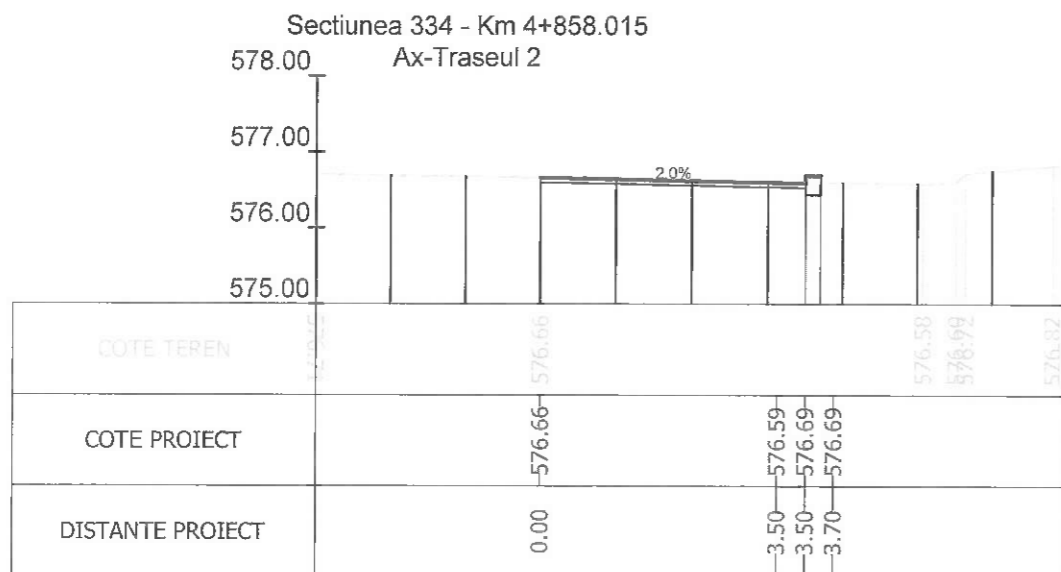
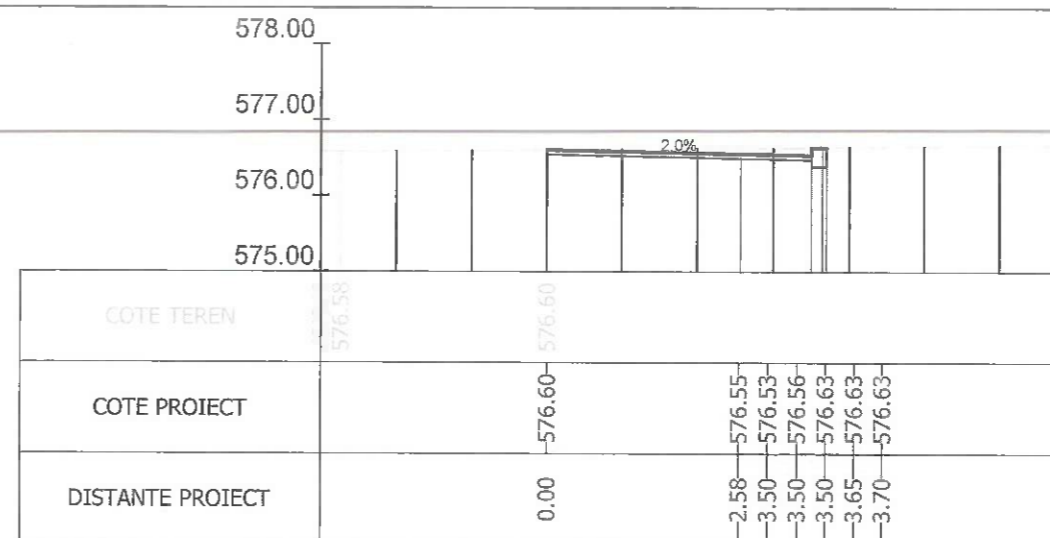
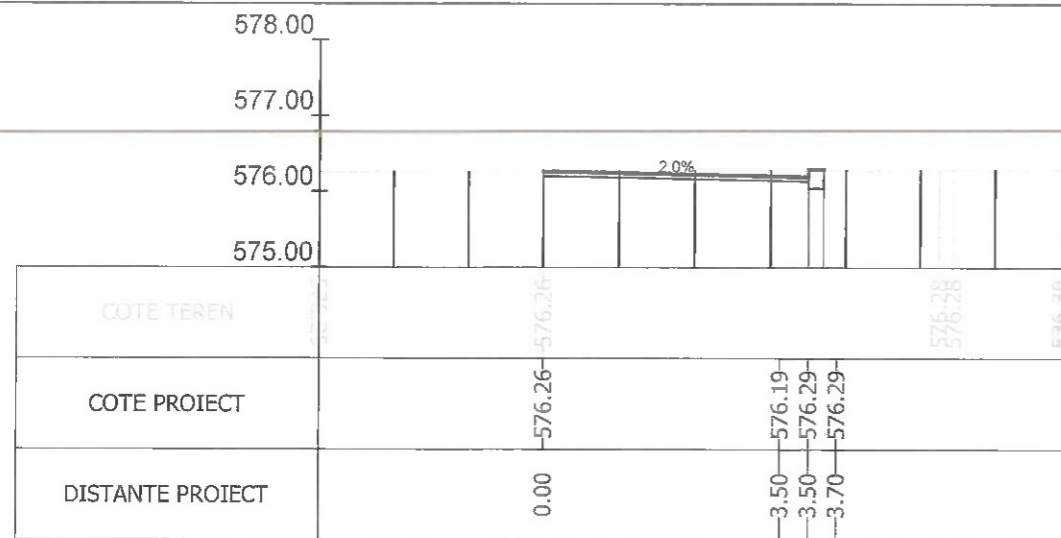

Sectiunea 339 - Km 4+950
Ax-Traseul 2

Index	Data	Rev. 5
A		

HENTZA BUSINESS
www.hentza.ro

Sef Proiect	Ing. A. Buta	Scara	1/100
Proiectat	Ing. A. Buta	Data	07/2023
Desenat	Ing. S. Patroi		
Verificat			

Beneficiar:	MUNICIPIUL BRASOV Bulevardul Eroilor 8, Brasov 500007	Nr. proiect	73 / 2020
Titlu proiect:	AMENAJARE BENZI DEDICATE TRANSPORTULUI PUBLIC IN MUNICIPIUL BRASOV SI TROTUARE ADIACENTE	Faza	P.T.
Titlu plansa:	PROFILE TRANSVERSALE CURENTE	Nr. plansa	PT-114

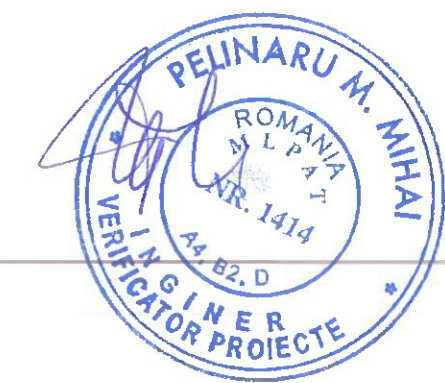

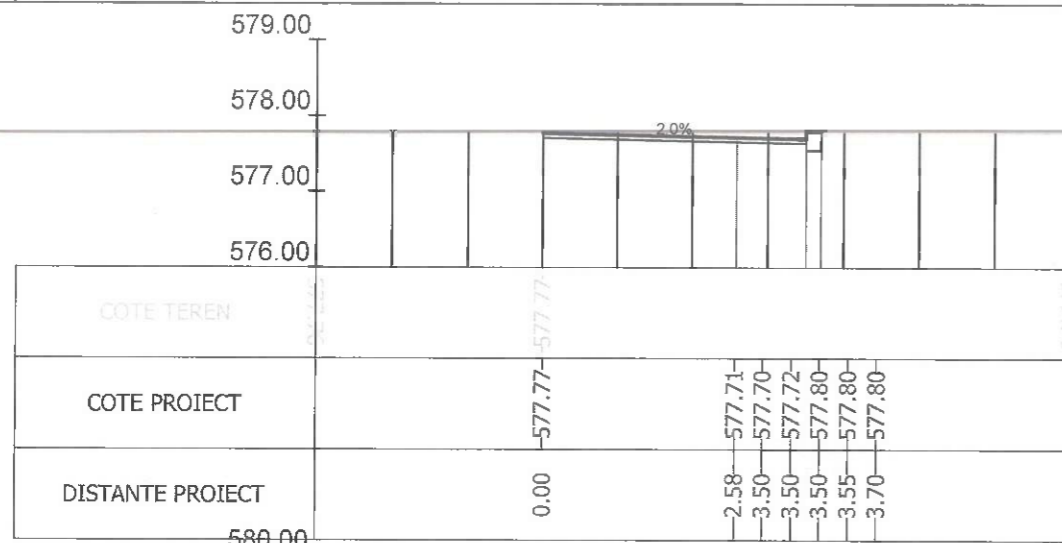

Sectiunea 340 - Km 4+975
Ax-Traceul 2

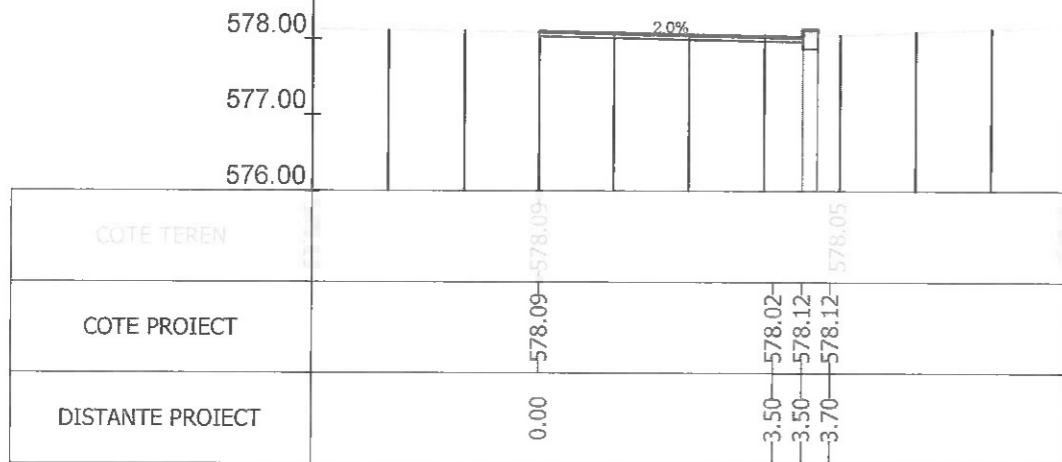

Sectiunea 342 - Km 5+015.780
Ax-Traceul 2

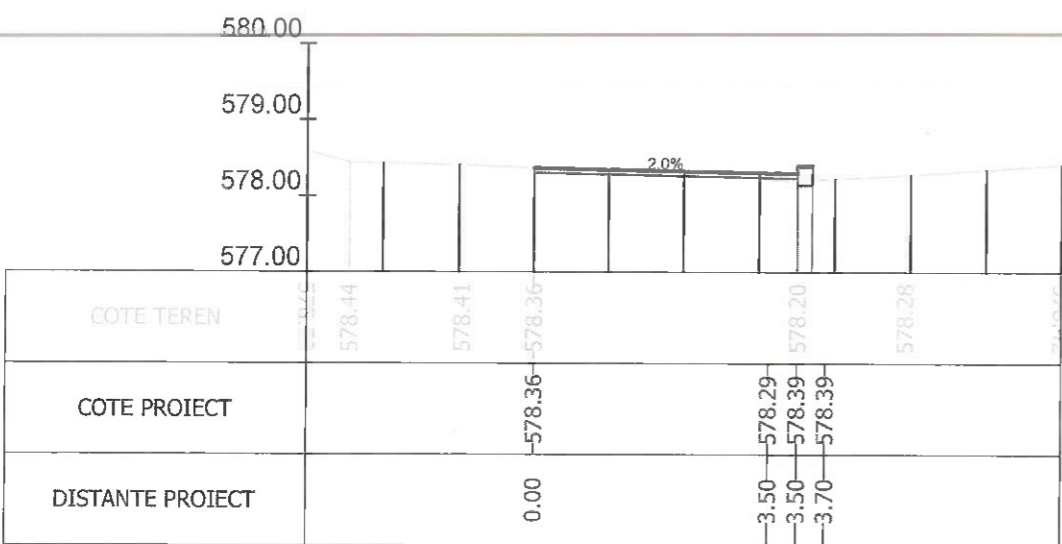

Sectiunea 344 - Km 5+038.588
Ax-Traceul 2

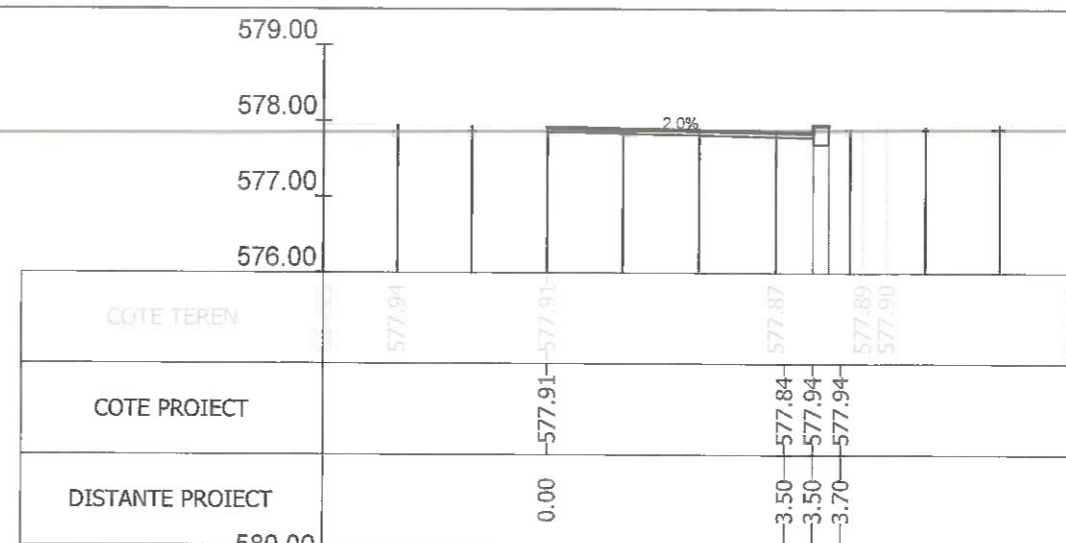

Sectiunea 341 - Km 5+000
Ax-Traceul 2

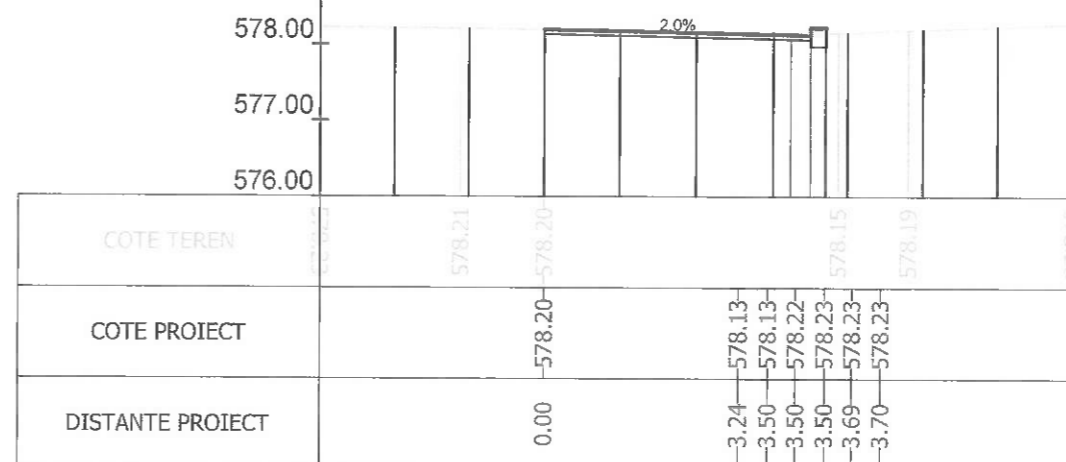

Sectiunea 343 - Km 5+025
Ax-Traceul 2

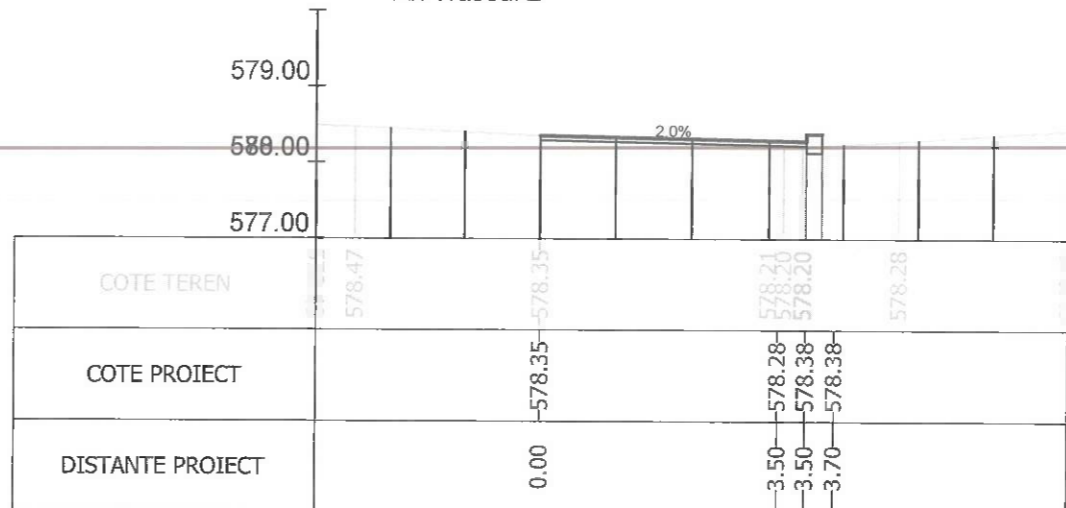

Sectiunea 345 - Km 5+041.048
Ax-Traceul 2



Index	A		Rev. 5
			Beneficiar: MUNICIPIUL BRASOV Bulevardul Eroilor 8, Brasov 500007
Sef Proiect: Ing. A. Buta Proiectat: Ing. A. Buta Desenat: Ing. S. Patroi Verificat:			Nr. proiect: 73 / 2020 Faza: P.T. Nr. plansa: PT-115
Scara: 1/100 Data: 07/2023			Titlu proiect: AMENAJARE BENZI DEDICATE TRANSPORTULUI PUBLIC IN MUNICIPIUL BRASOV SI TROTUARE ADIACENTE Titlu plansa: PROFILE TRANSVERSALE CURENTE

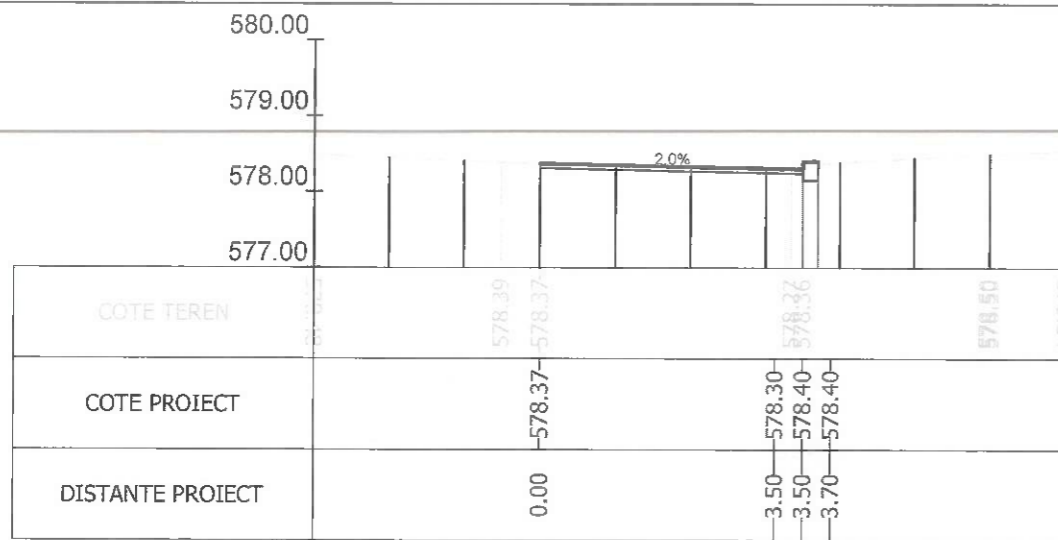

Sectiunea 346 - Km 5+043.508

Ax-Traseul 2

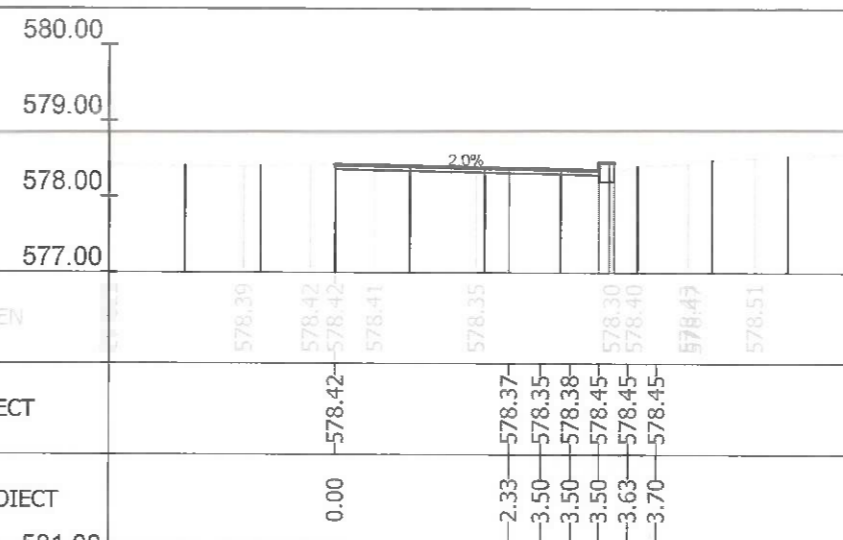
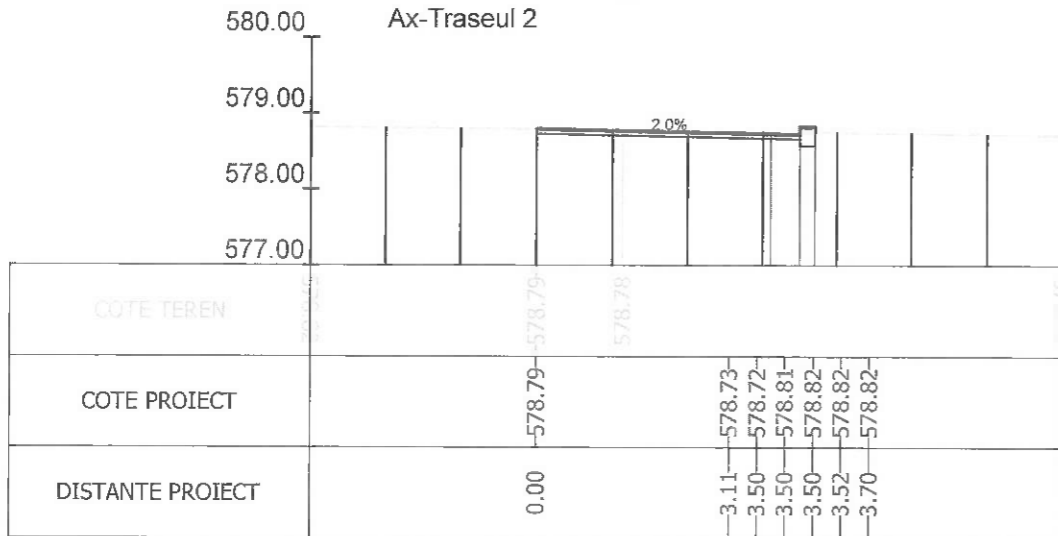

Sectiunea 347 - Km 5+050

Ax-Traseul 2

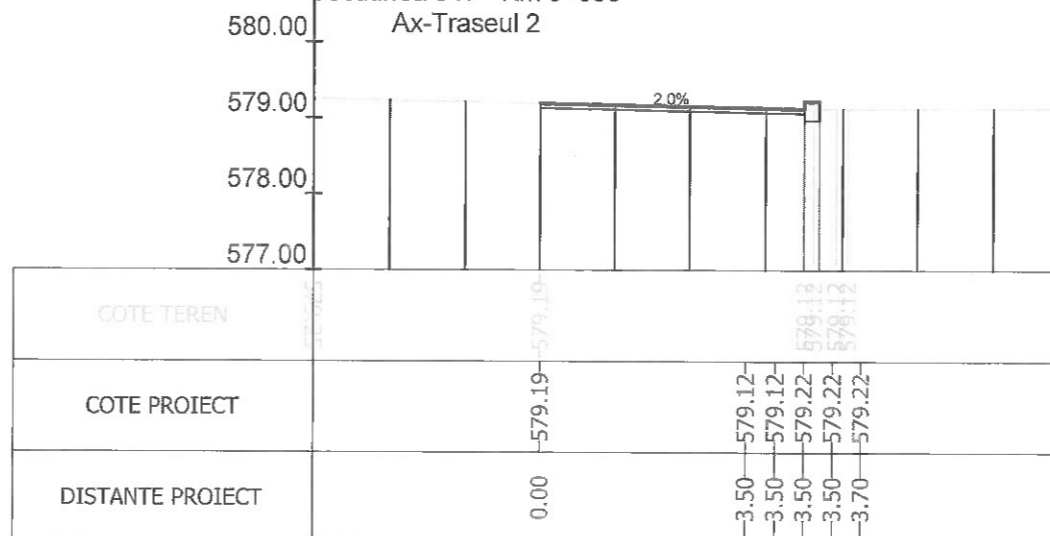

Sectiunea 349 - Km 5+098.175

Ax-Traseul 2

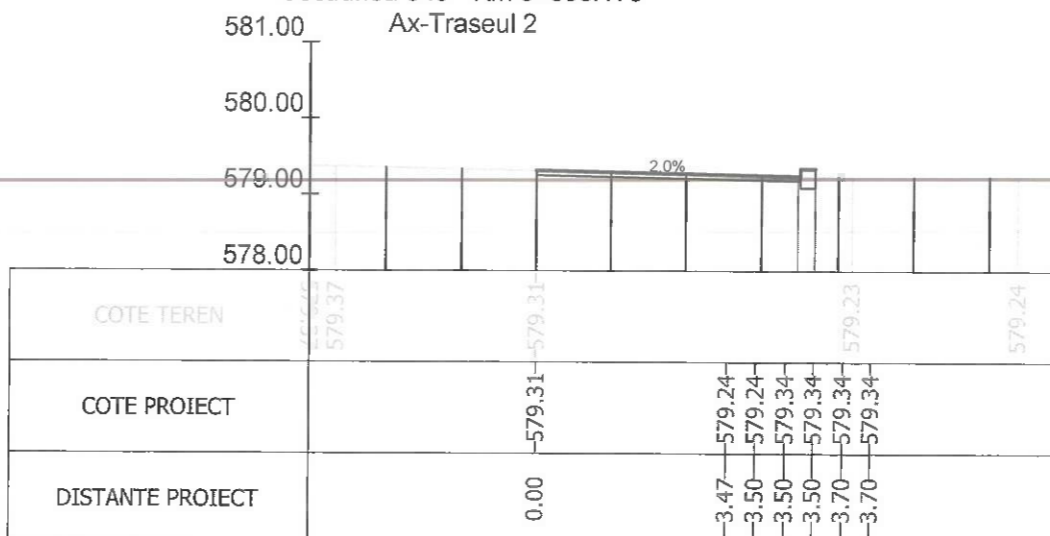

Sectiunea 348 - Km 5+075

Ax-Traseul 2

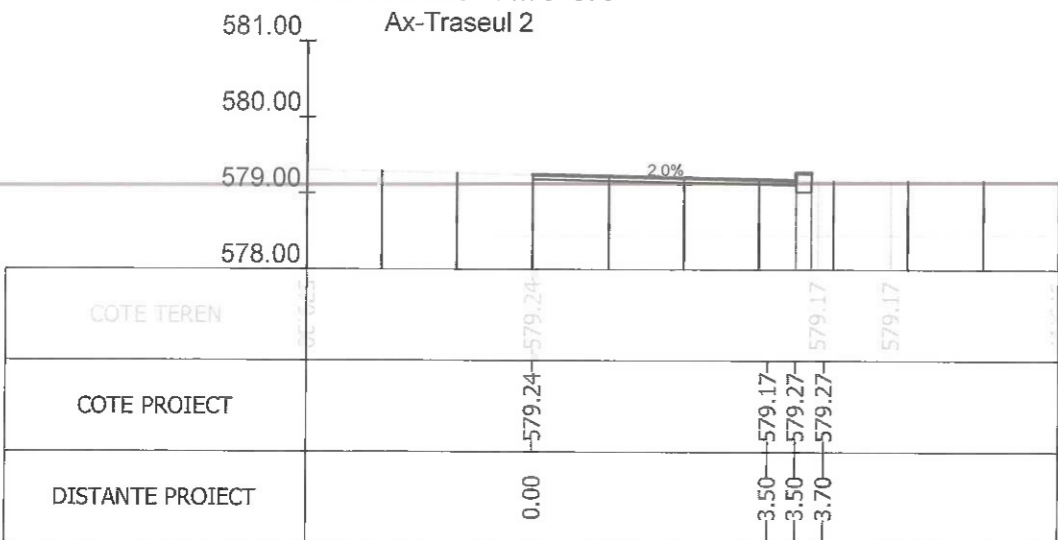

Sectiunea 350 - Km 5+100

Ax-Traseul 2

Sectiunea 351 - Km 5+102.576

Index	A		Rev. 5
			
Beneficiar:		MUNICIPIUL BRASOV Bulevardul Eroilor 8, Brasov 500007	Nr. proiect 73 / 2020
Titlu proiect:		AMENAJARE BENZI DEDICATE TRANSPORTULUI PUBLIC IN MUNICIPIUL BRASOV SI TROTUARE ADIACENTE	Faza P.T.
Titlu plansa:		PROFILE TRANSVERSALE CURENTE	Nr. plansa PT-116
Sef Proiect	Ing. A. Buta	Scara	1/100
Proiectat	Ing. A. Buta	Data	07/2023
Desenat	Ing. S. Patroi		
Verificat			



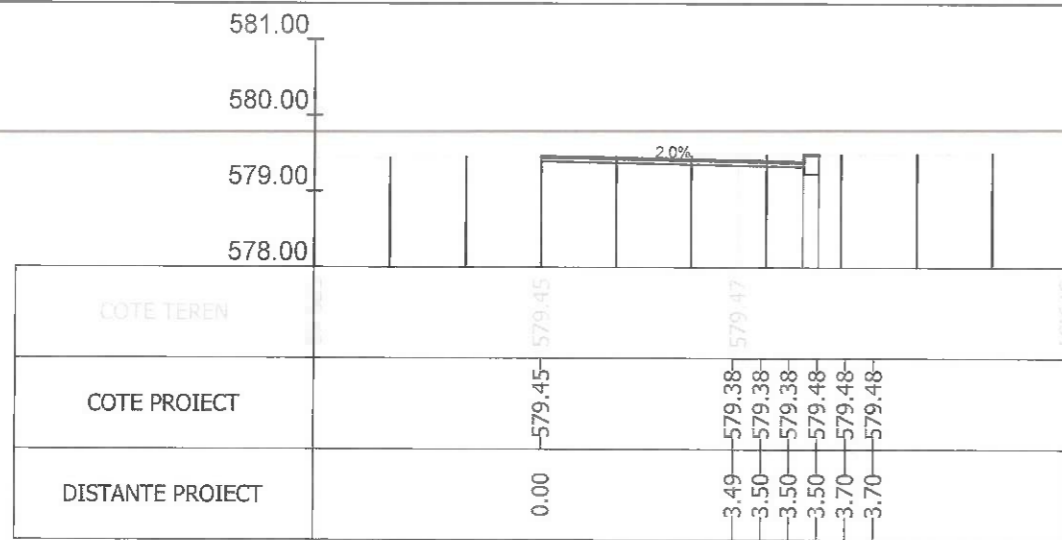

Sectiunea 352 - Km 5+125
Ax-Traseul 2

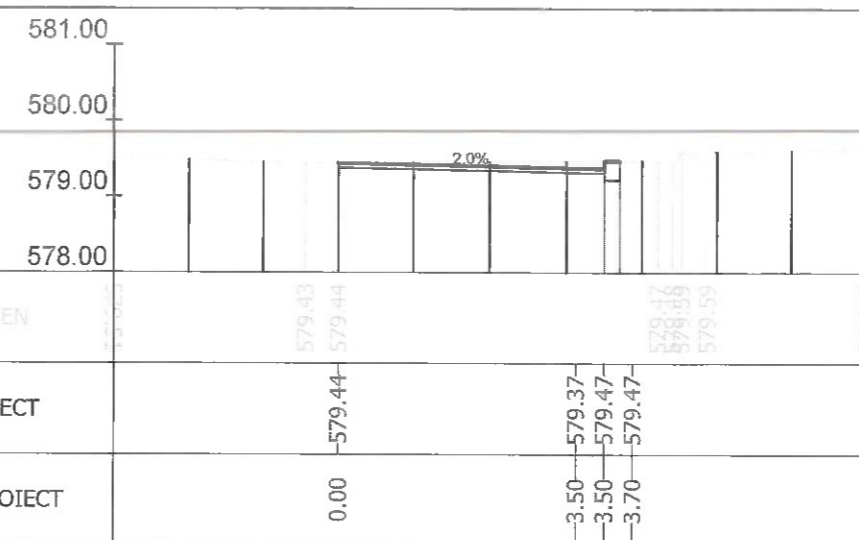
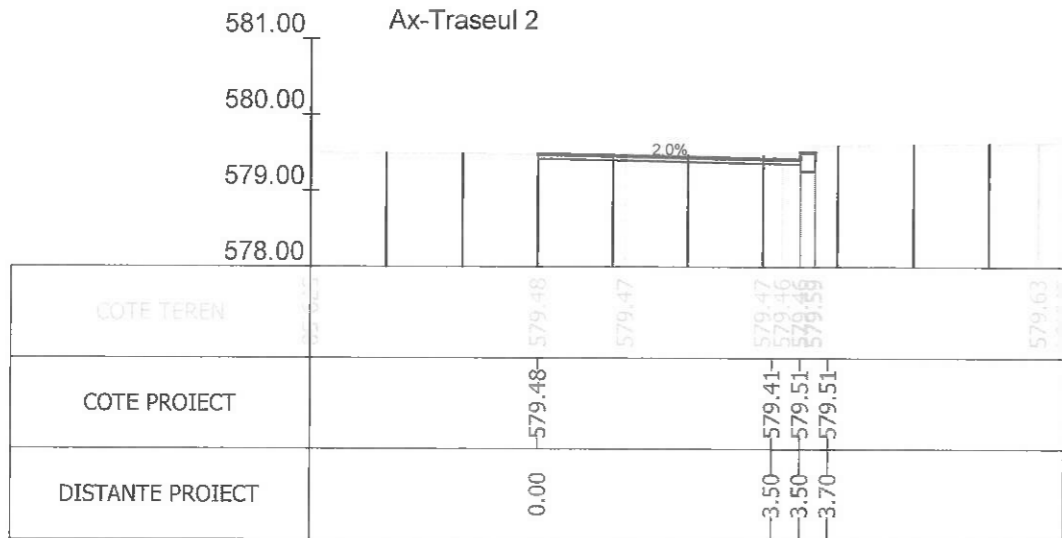

Sectiunea 353 - Km 5+138.457
Ax-Traseul 2

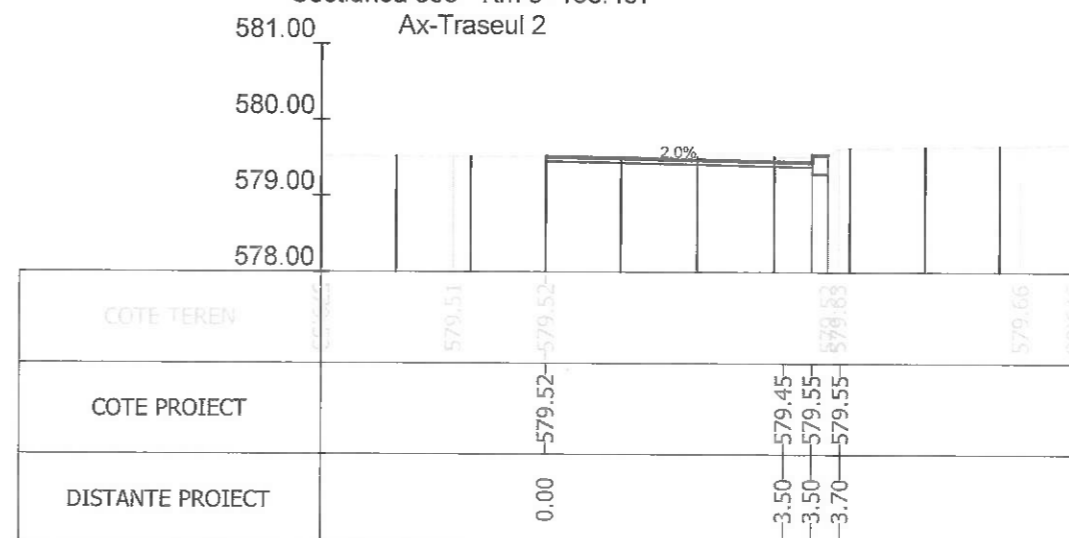

Sectiunea 354 - Km 5+141.220
Ax-Traseul 2

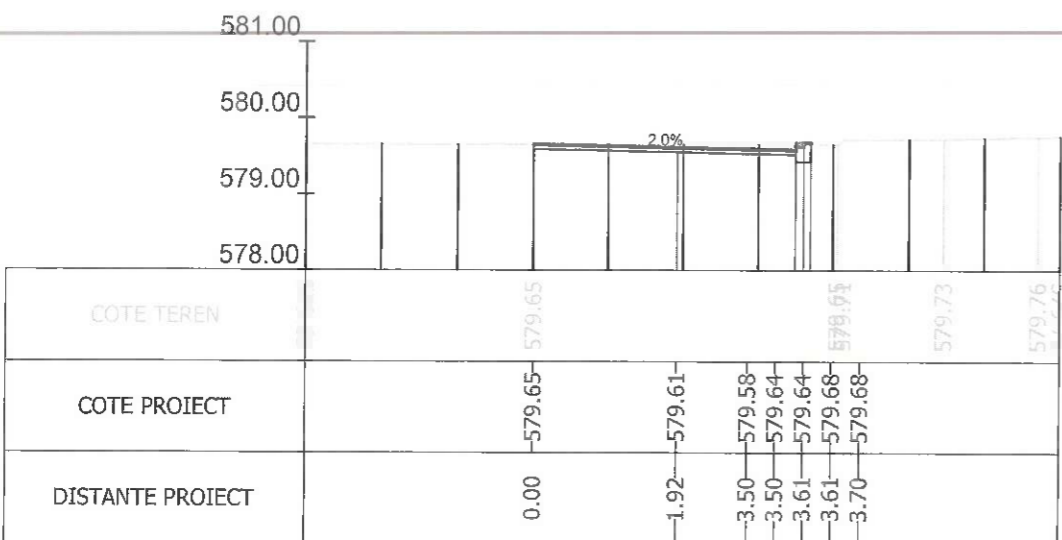

Sectiunea 355 - Km 5+143.984
Ax-Traseul 2

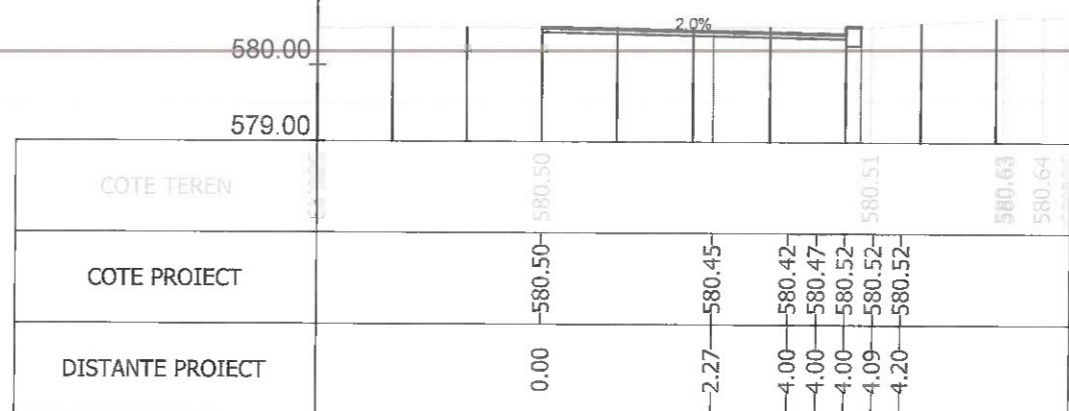

Sectiunea 356 - Km 5+150
Ax-Traseul 2

Sectiunea 362 - Km 5+250
Ax-Traseul 2

Index	Data	Rev. 5
A		
		Beneficiar: MUNICIPIUL BRASOV Bulevardul Eroilor 8, Brasov 500007
Sef Proiect	Ing. A. Buta	Nr. proiect: 73 / 2020
Proiectat	Ing. A. Buta	Faza P.T.
Desenat	Ing. S. Patroi	Nr. plansa: PT-117
Verificat		
Scara 1/100		Titlu proiect: AMENAJARE BENZI DEDICATE TRANSPORTULUI PUBLIC IN MUNICIPIUL BRASOV SI TROTUARE ADIACENTE
Data 07/2023		Titlu plansa: PROFILE TRANSVERSALE CURENTE



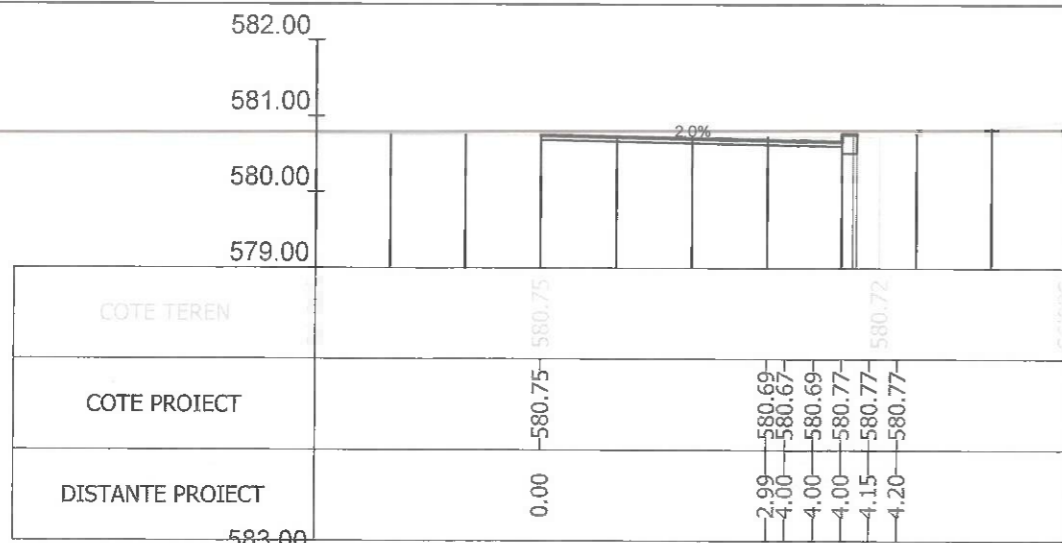

Sectiunea 363 - Km 5+275
Ax-Traseul 2

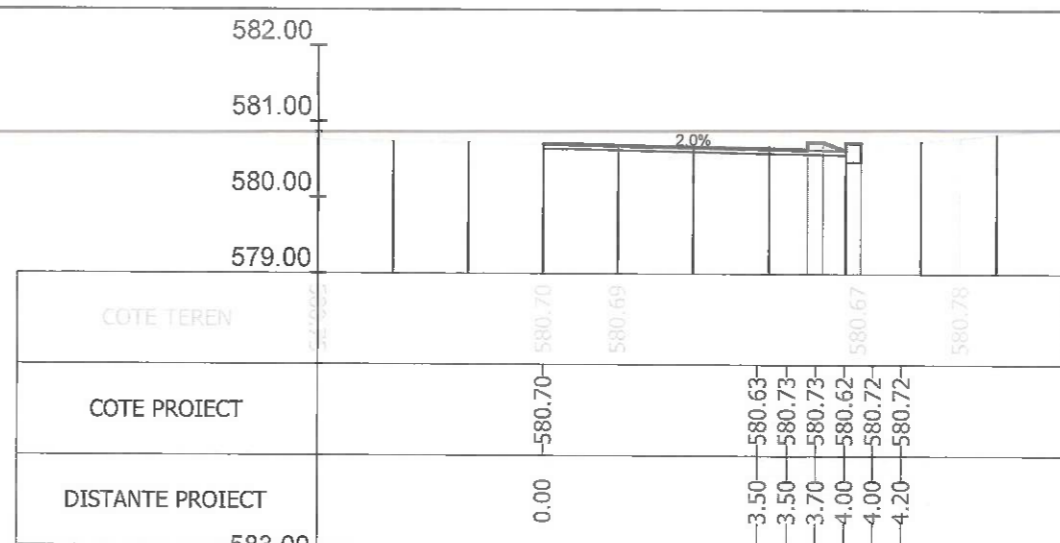

Sectiunea 364 - Km 5+276.293
Ax-Traseul 2

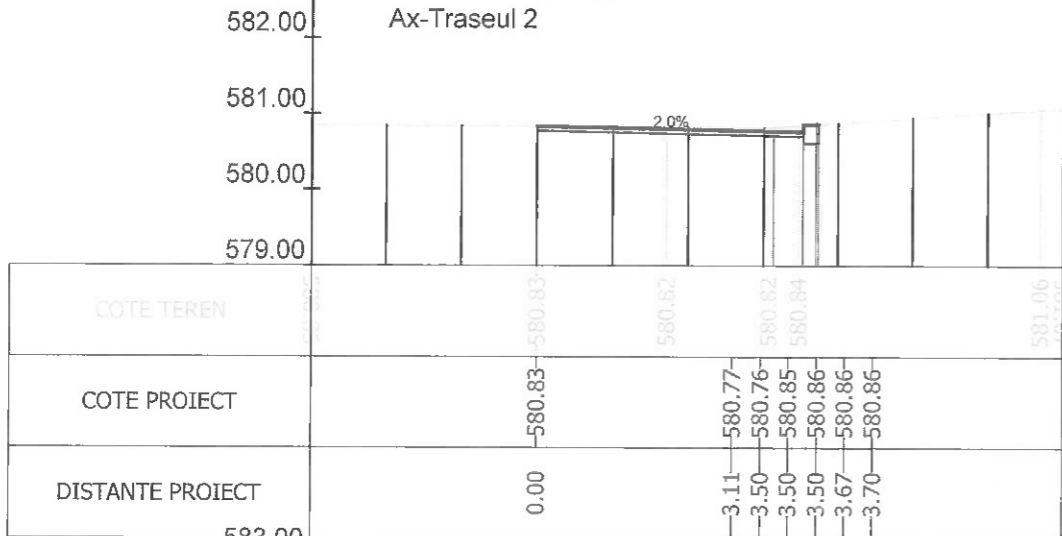

Sectiunea 365 - Km 5+290.051
Ax-Traseul 2

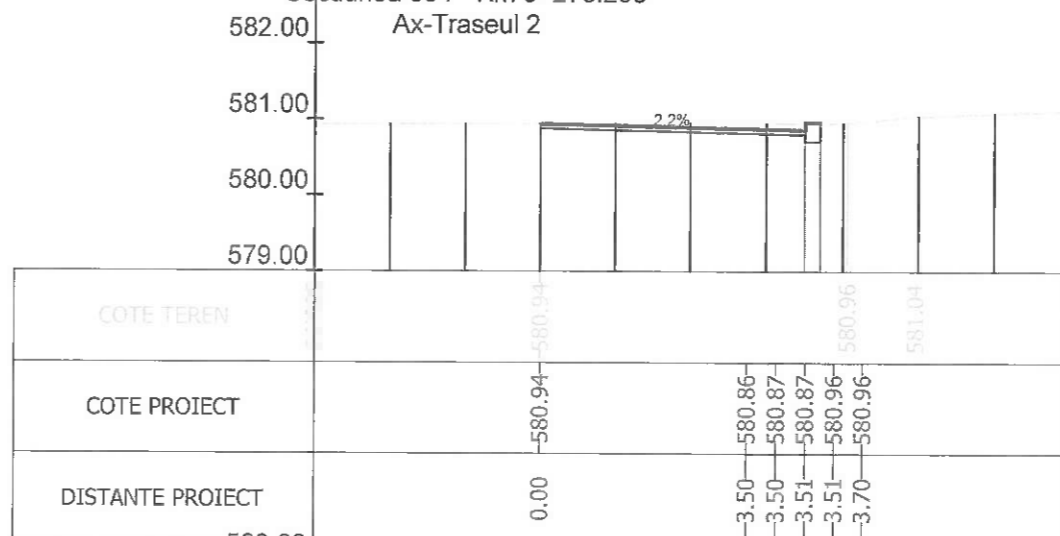

Sectiunea 366 - Km 5+295.740
Ax-Traseul 2

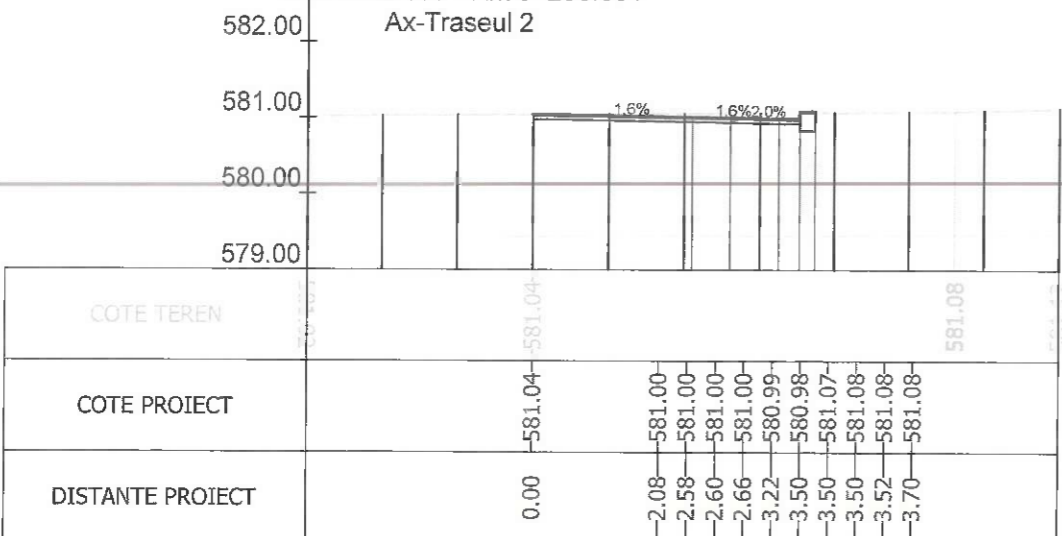

Sectiunea 367 - Km 5+299.634
Ax-Traseul 2

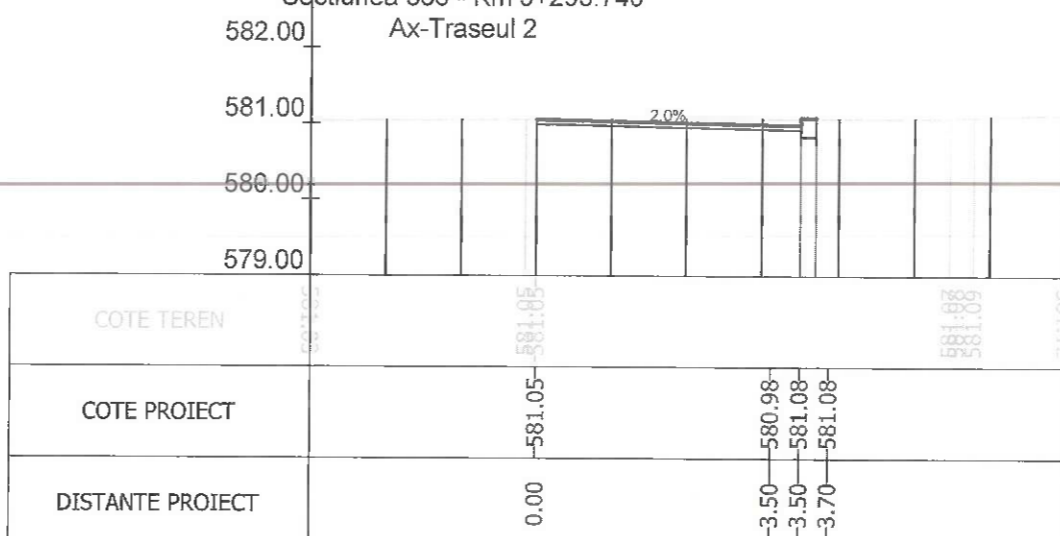

Sectiunea 368 - Km 5+300
Ax-Traseul 2



Index A	Data 12.12.2021	Rev. 5
		Beneficiar: MUNICIPIUL BRASOV Bulevardul Eroilor 8, Brasov 500007
Sef Proiect Ing. A. Buta	Scara 1/100	Nr. proiect 73 / 2020
Proiectat Ing. A. Buta	Data 07/2023	Faza P.T.
Desenat Ing. S. Patroi		Nr. planşa PT-118
Verificat		
		Titlu proiect: AMENAJARE BENZI DEDICATE TRANSPORTULUI PUBLIC IN MUNICIPIUL BRASOV SI TROTUARE ADIACENTE
		Titlu planşa: PROFILE TRANSVERSALE CURENTE

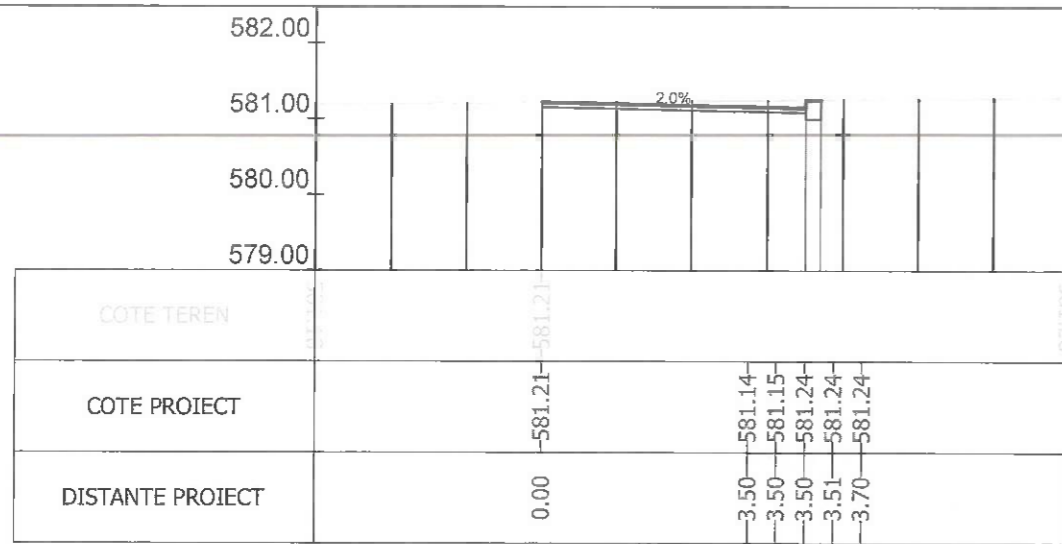

Sectiunea 369 - Km 5+314.079

Ax-Traseul 2

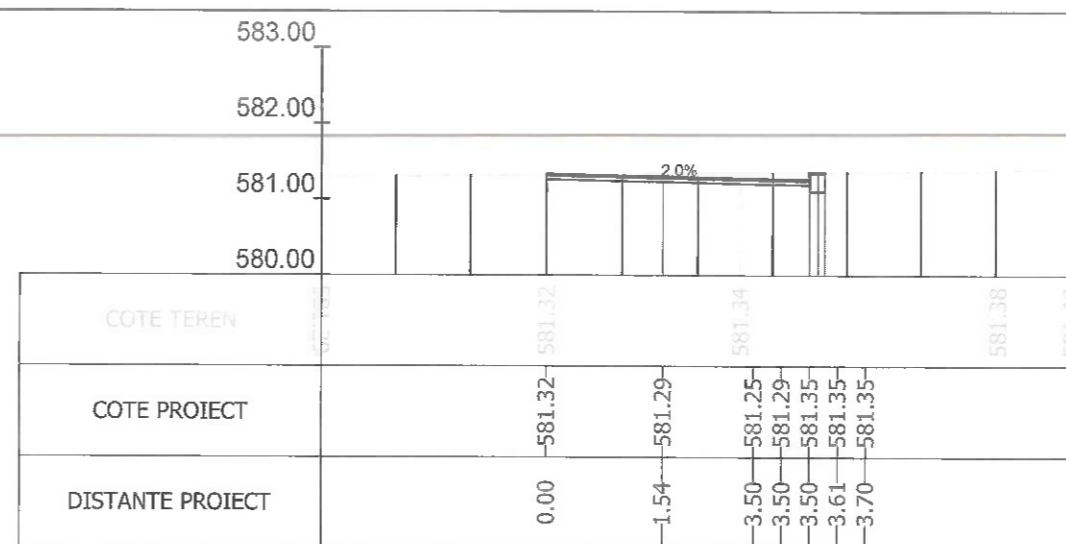
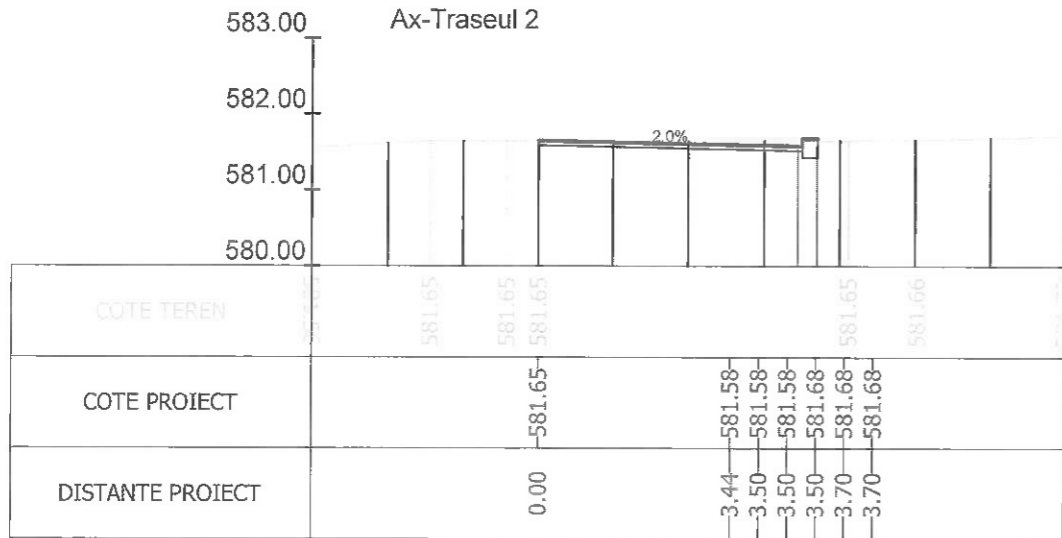

Sectiunea 370 - Km 5+325

Ax-Traseul 2

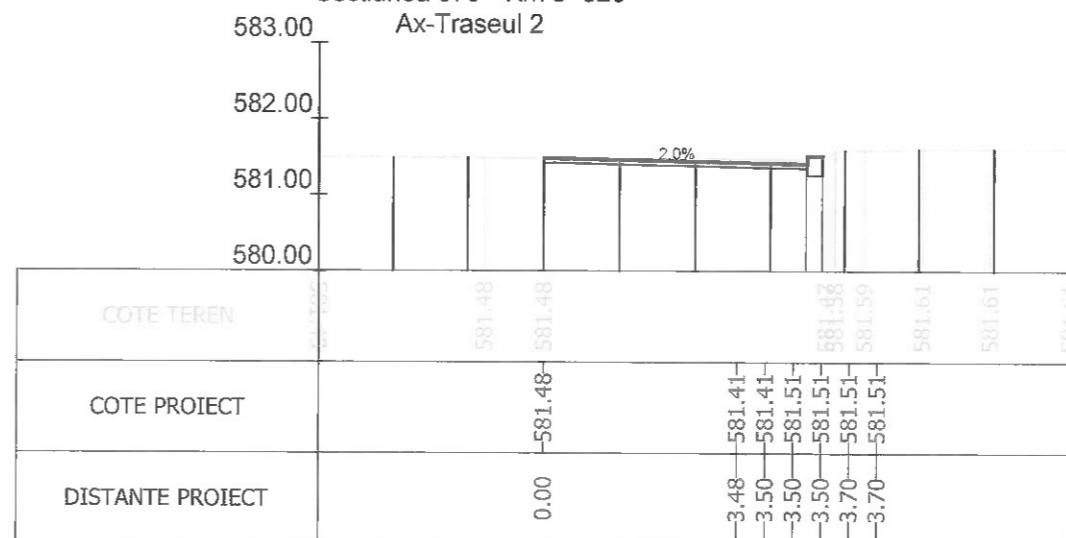

Sectiunea 371 - Km 5+350

Ax-Traseul 2

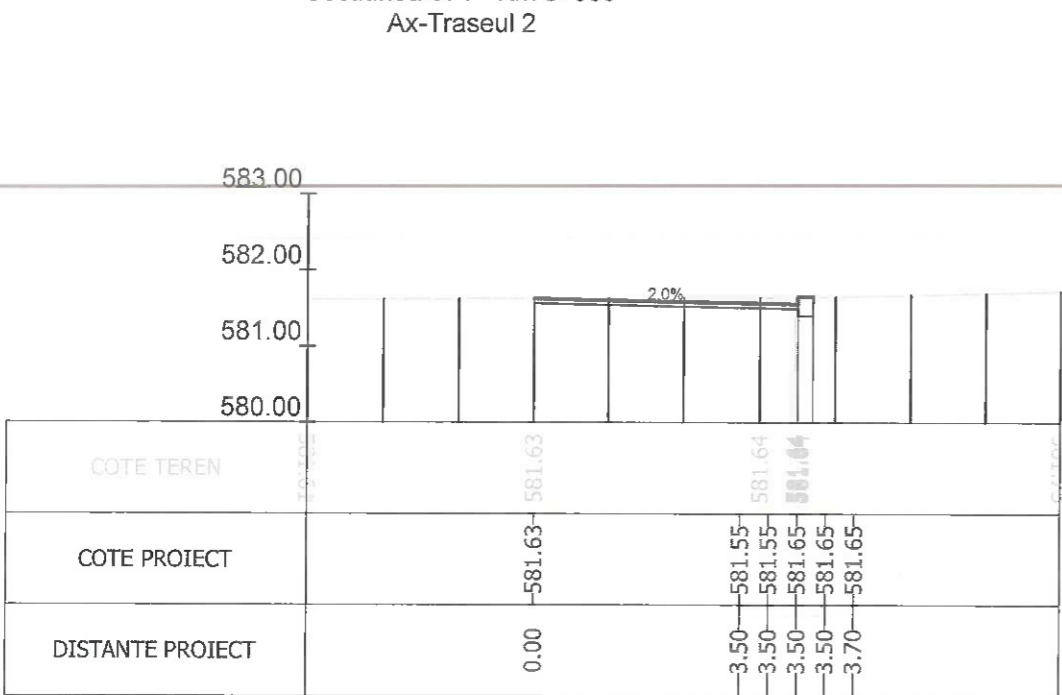

Sectiunea 373 - Km 5+370.688

Ax-Traseul 2

Sectiunea 372 - Km 5+354.022

Ax-Traseul 2

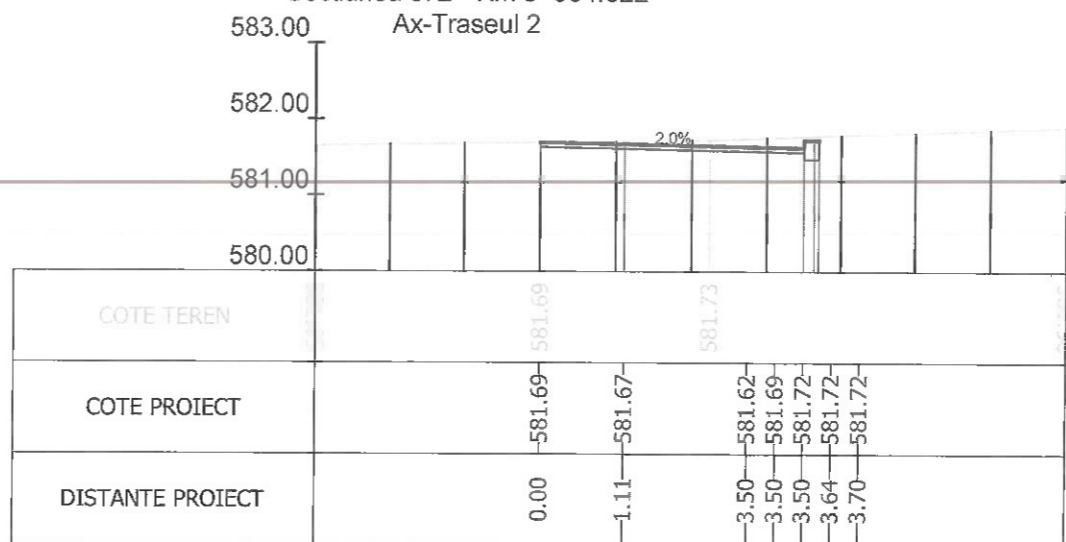

Sectiunea 374 - Km 5+375

Index	Data	Rev. 5
A		
		Beneficiar:
Sef Proiect: Ing. A. Buta Proiectat: Ing. A. Buta Desenat: Ing. S. Patroi Verificat:		MUNICIPIUL BRASOV Bulevardul Eroilor 8, Brasov 500007
Scara: 1/100 Data: 07/2023		Nr. proiect: 73 / 2020 Faza: P.T. Nr. plansa: PT-119
		Titlu proiect: AMENAJARE BENZI DEDICATE TRANSPORTULUI PUBLIC IN MUNICIPIUL BRASOV SI TROTUARE ADIACENTE Titlu plansa: PROFILE TRANSVERSALE CURENTE

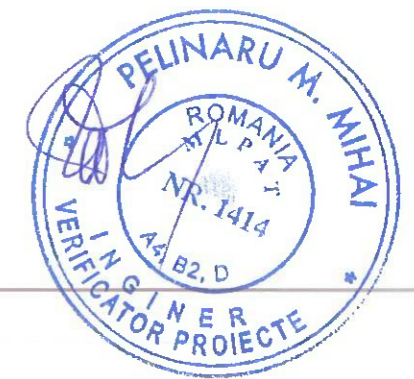

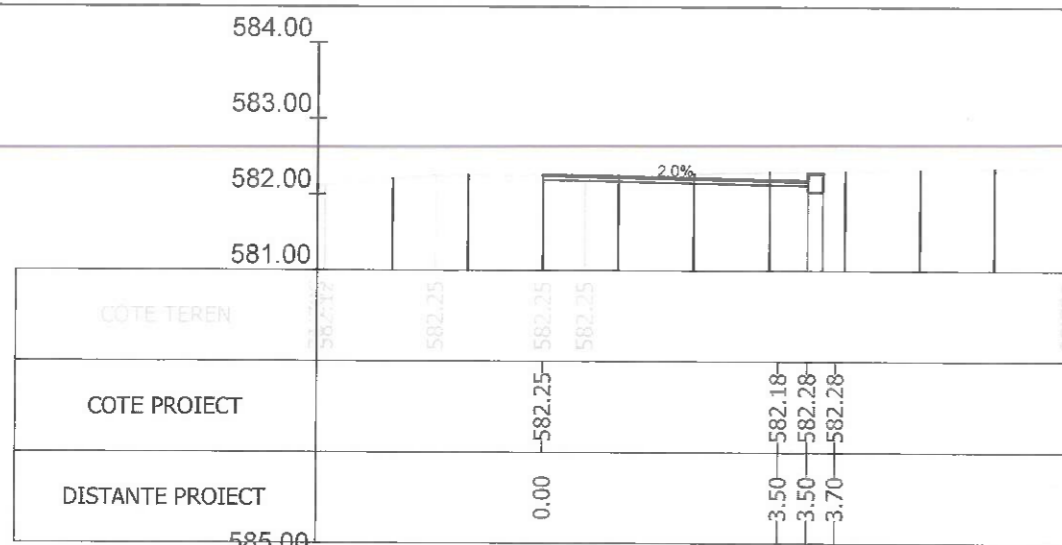

Sectiunea 375 - Km 5+400
Ax-Traseul 2

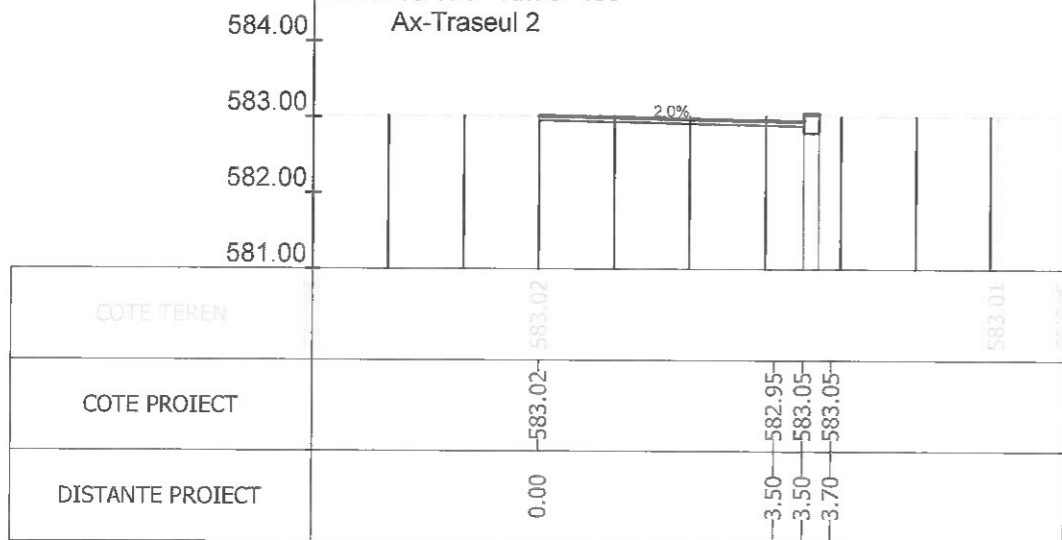

Sectiunea 377 - Km 5+446.626
Ax-Traseul 2

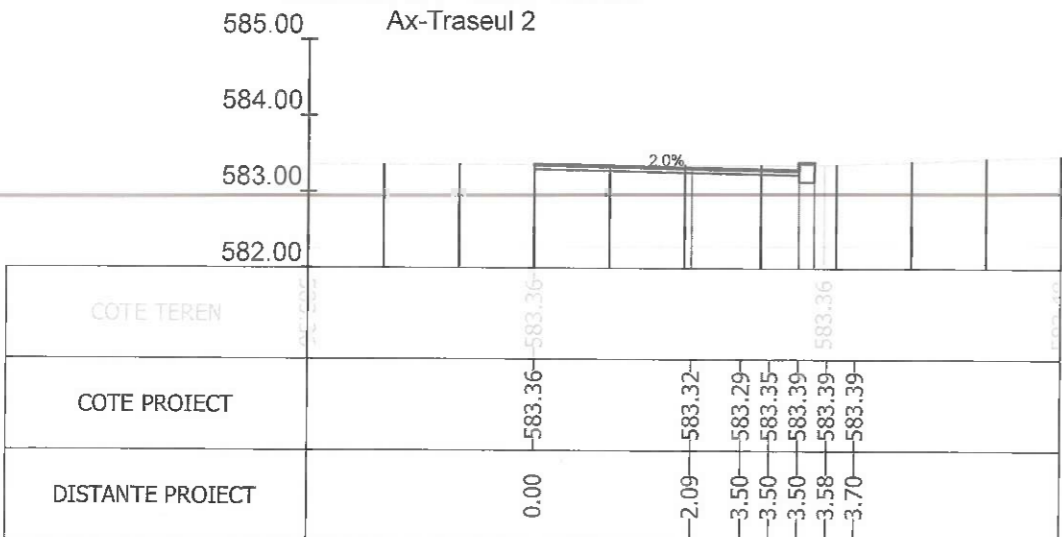

Sectiunea 379 - Km 5+475
Ax-Traseul 2

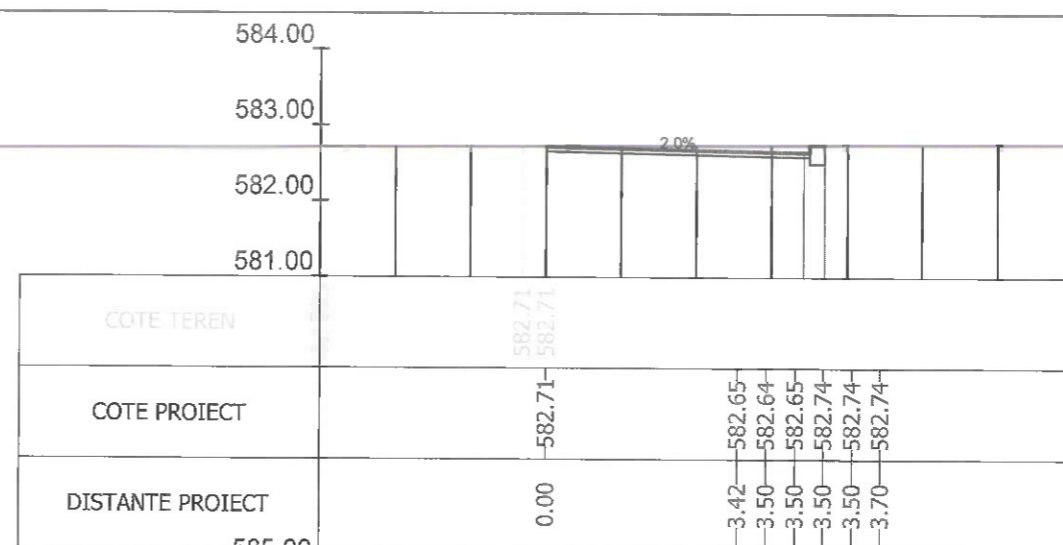

Sectiunea 376 - Km 5+425
Ax-Traseul 2

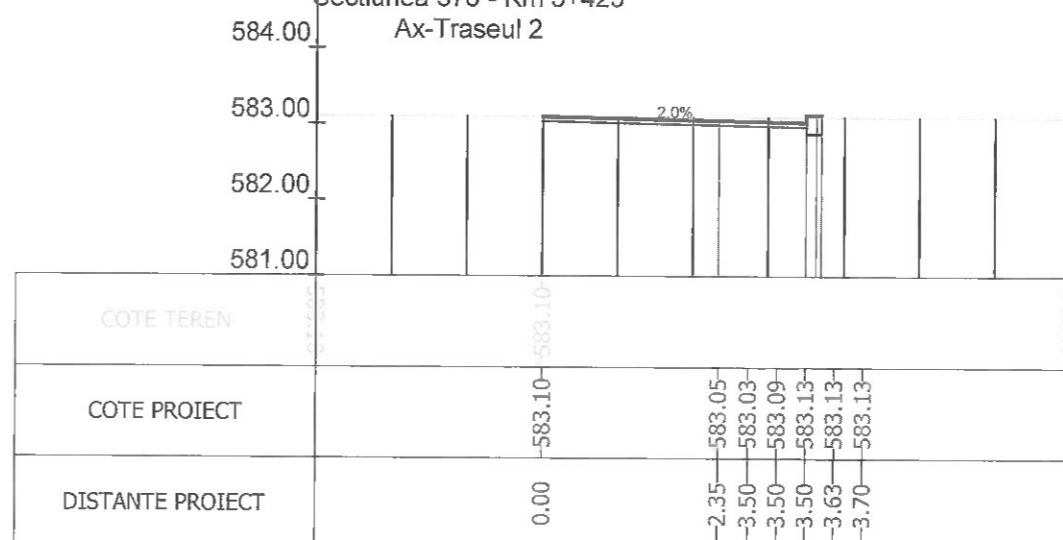

Sectiunea 378 - Km 5+450
Ax-Traseul 2

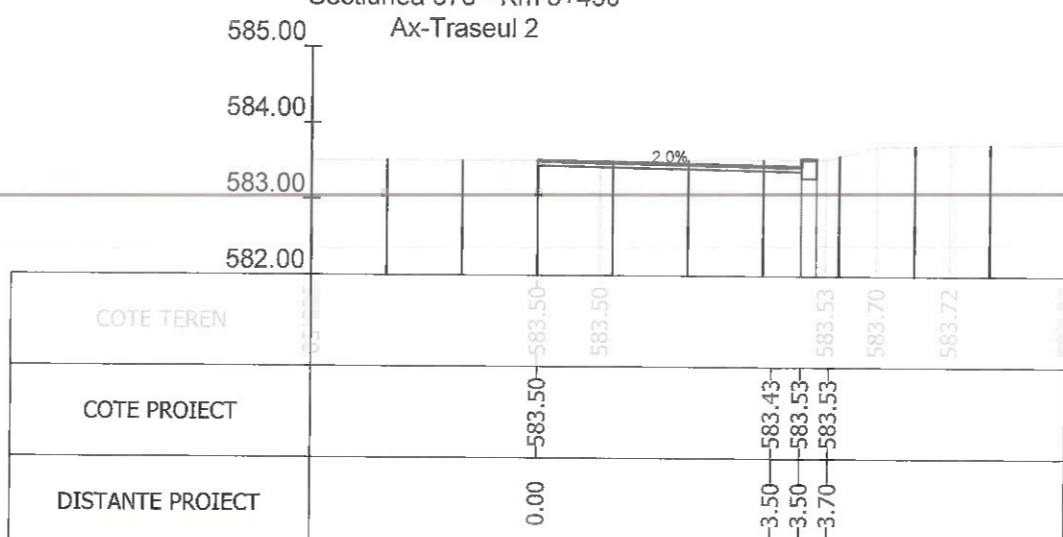

Sectiunea 380 - Km 5+500
Ax-Traseul 2



Index	Data	Rev. 5
A		
		Beneficiar:
Sef Proiect: Ing. A. Buta Proiectat: Ing. A. Buta Desenat: Ing. S. Patroi Verificat:		MUNICIPIUL BRASOV Bulevardul Eroilor 8, Brasov 500007
Scara: 1/100 Data: 07/2023		Nr. proiect: 73 / 2020 Faza: P.T. Nr. plansa: PT-120
		Titlu proiect: AMENAJARE BENZI DEDICATE TRANSPORTULUI PUBLIC IN MUNICIPIUL BRASOV SI TROTUARE ADIACENTE Titlu plansa: PROFILE TRANSVERSALE CURENTE

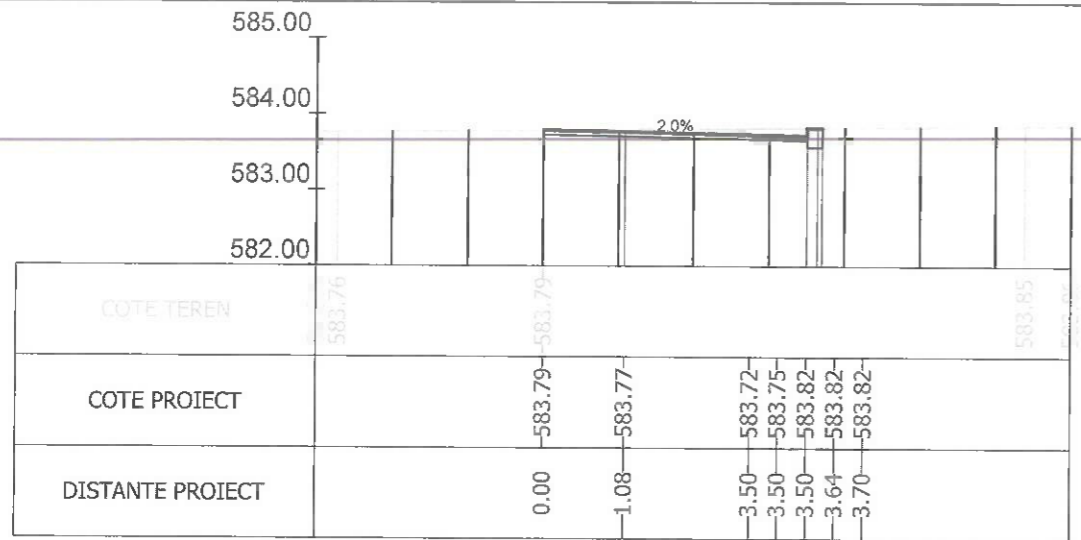

Sectiunea 381 - Km 5+525
Ax-Traseul 2

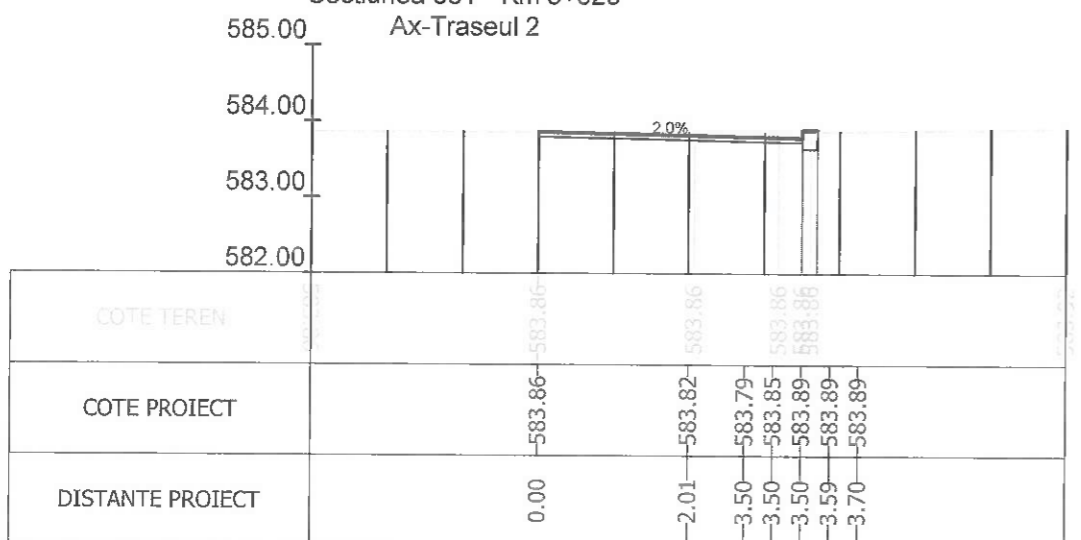

Sectiunea 383 - Km 5+550
Ax-Traseul 2

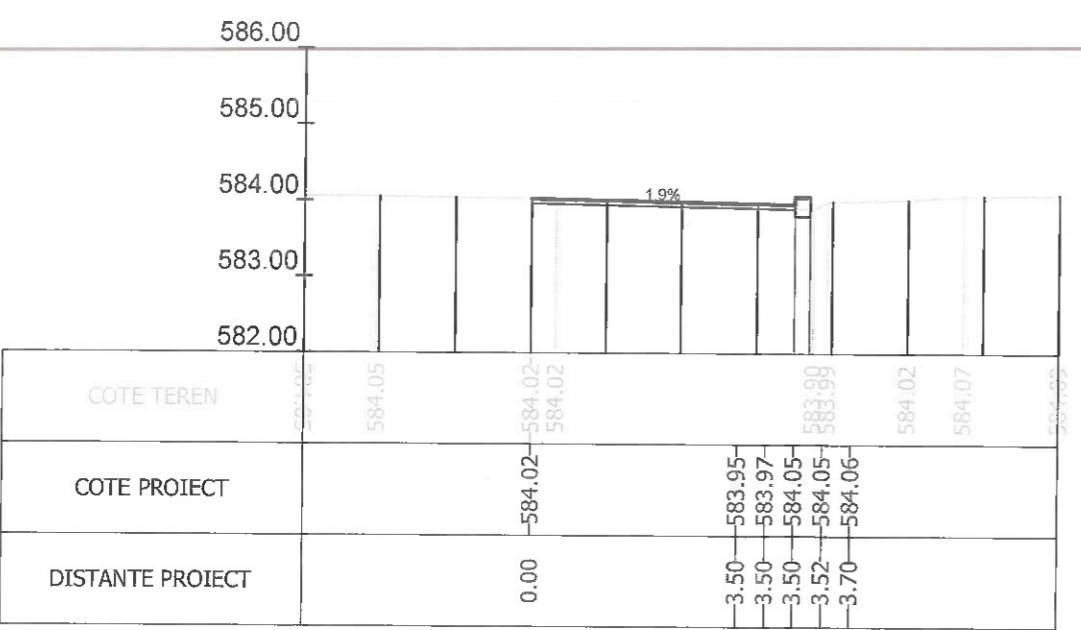

Sectiunea 385 - Km 5+584.258
Ax-Traseul 2

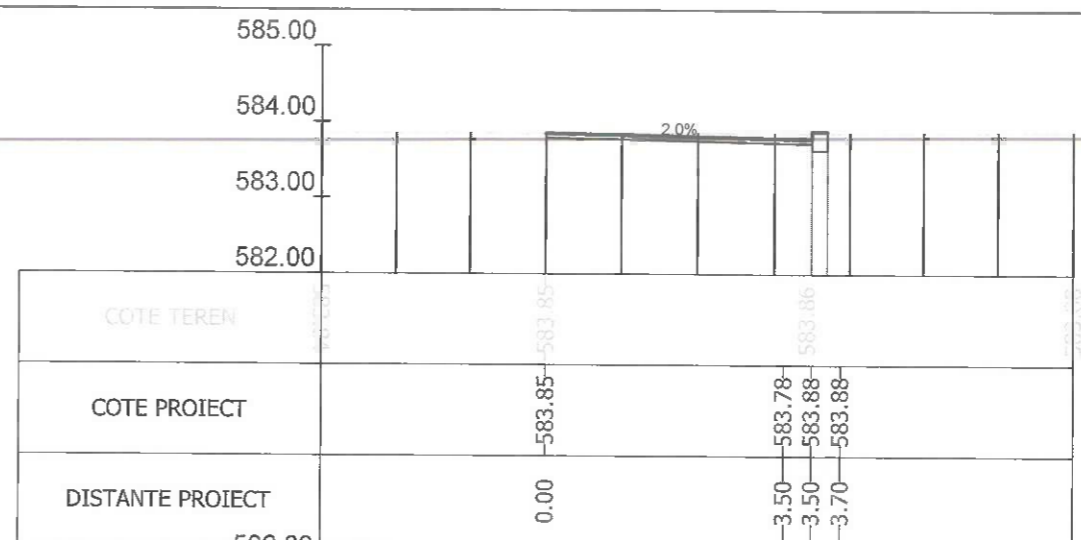

Sectiunea 382 - Km 5+543.857
Ax-Traseul 2

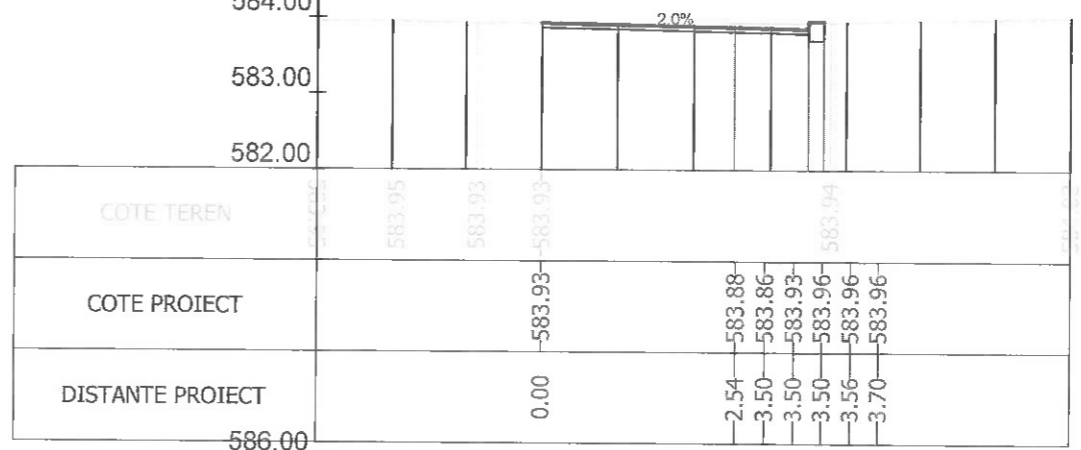

Sectiunea 384 - Km 5+575
Ax-Traseul 2

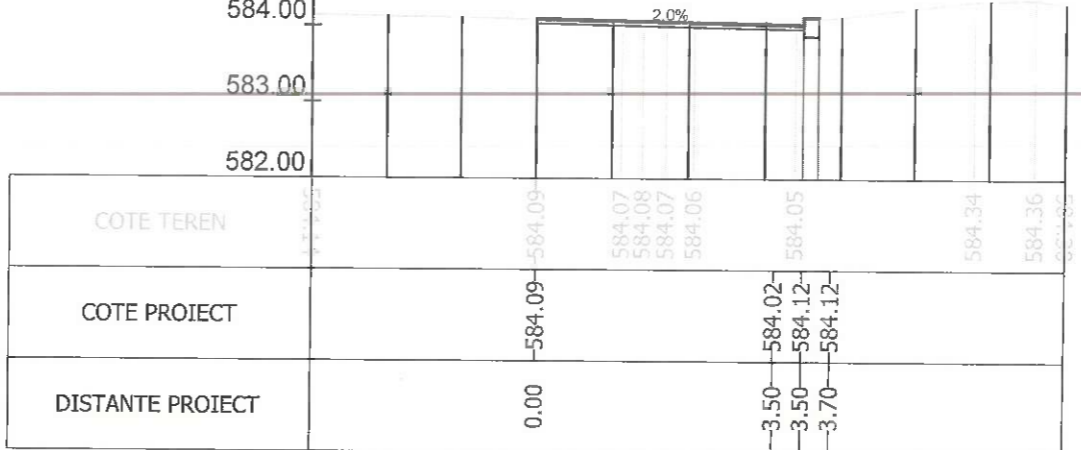

Sectiunea 386 - Km 5+600
Ax-Traseul 2

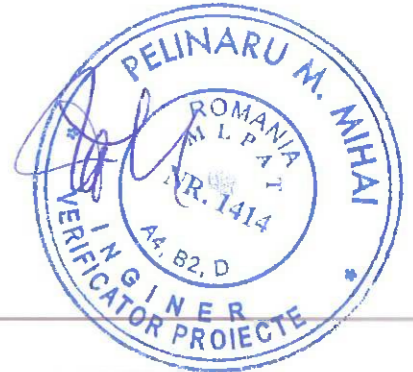

Index	Data	Observatii	Rev. 5
A			
		Beneficiar:	MUNICIPIUL BRASOV Bulevardul Eroilor 8, Brasov 500007
Sef Proiect: Ing. A. Buta Proiectat: Ing. A. Buta Desenat: Ing. S. Patroi Verificat:		Titlu proiect:	AMENAJARE BENZI DEDICATE TRANSPORTULUI PUBLIC IN MUNICIPIUL BRASOV SI TROTUARE ADIACENTE
Scara: 1/100 Data: 07/2023		Titlu planșă:	PROFILE TRANSVERSALE CURENTE
		Nr. proiect	73 / 2020
		Faza	P.T.
		Nr. planșă	PT-121

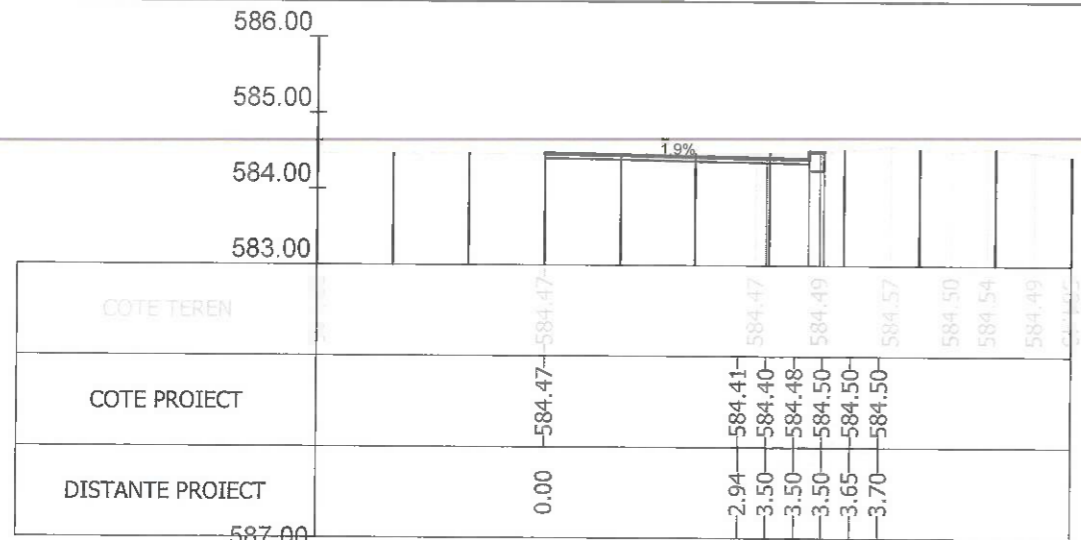

Sectiunea 387 - Km 5+604.572
Ax-Traseul 2

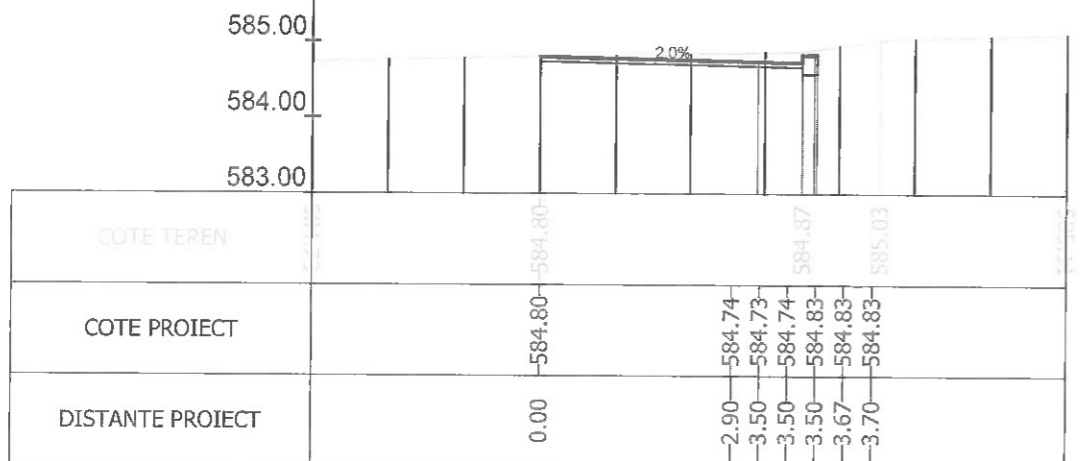

Sectiunea 389 - Km 5+625
Ax-Traseul 2

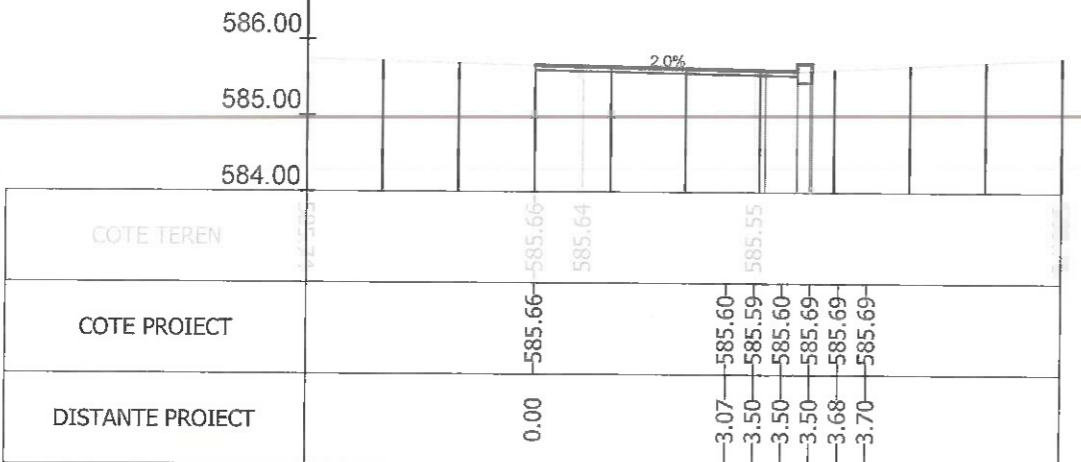

Sectiunea 391 - Km 5+675
Ax-Traseul 2

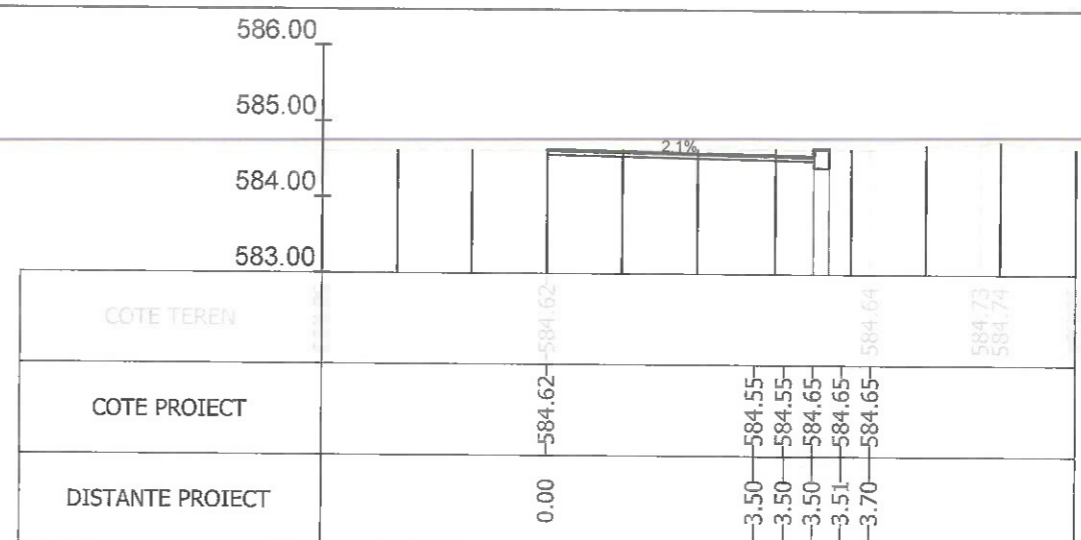

Sectiunea 388 - Km 5+608.639
Ax-Traseul 2

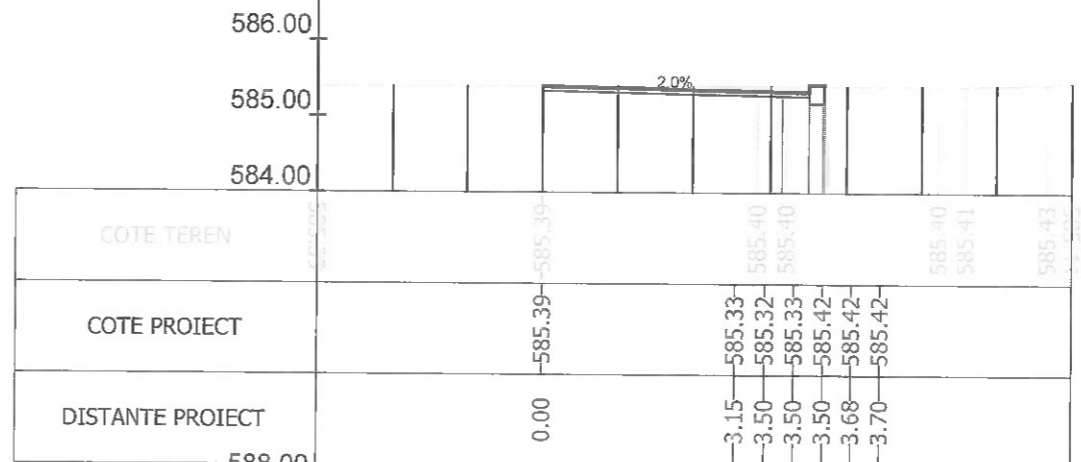

Sectiunea 390 - Km 5+650
Ax-Traseul 2

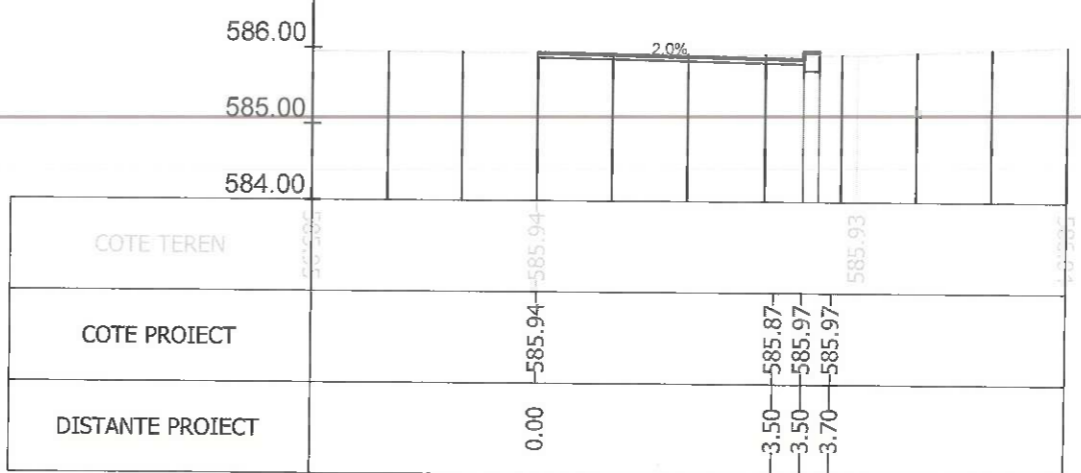

Sectiunea 392 - Km 5+700
Ax-Traseul 2

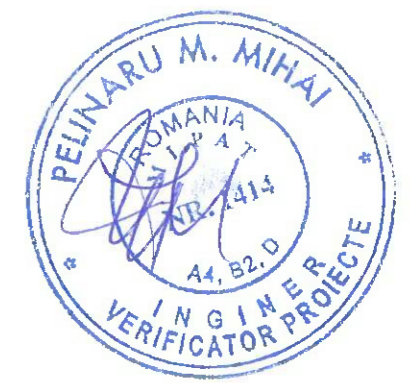

Index	Data Observatii		Rev. 5
A			
			Beneficiar:
			MUNICIPIUL BRASOV Bulevardul Eroilor 8, Brasov 500007
			Nr. proiect 73 / 2020
			Titlu proiect:
			AMENAJARE BENZI DEDICATE TRANSPORTULUI PUBLIC IN MUNICIPIUL BRASOV SI TROTUARE ADIACENTE
			Faza P.T.
			Titlu plansa:
			PROFILE TRANSVERSALE CURENTE
			Nr. plansa PT-122
Sef Proiect	Ing. A. Buta		Scara
Proiectat	Ing. A. Buta		1/100
Desenat	Ing. S. Patroi		Data
Verificat			07/2023

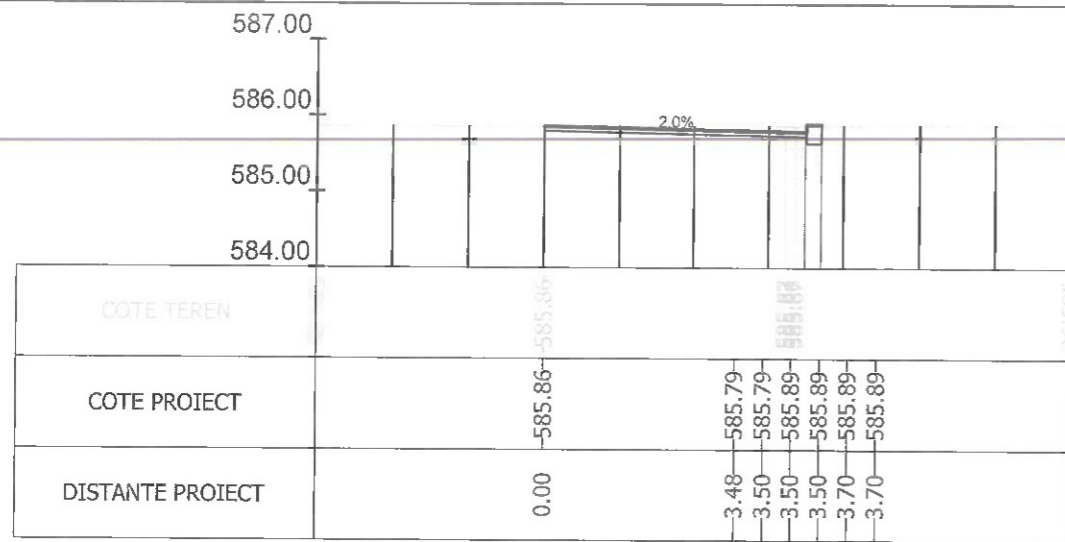

Sectiunea 393 - Km 5+706.293
Ax-Traseul 2

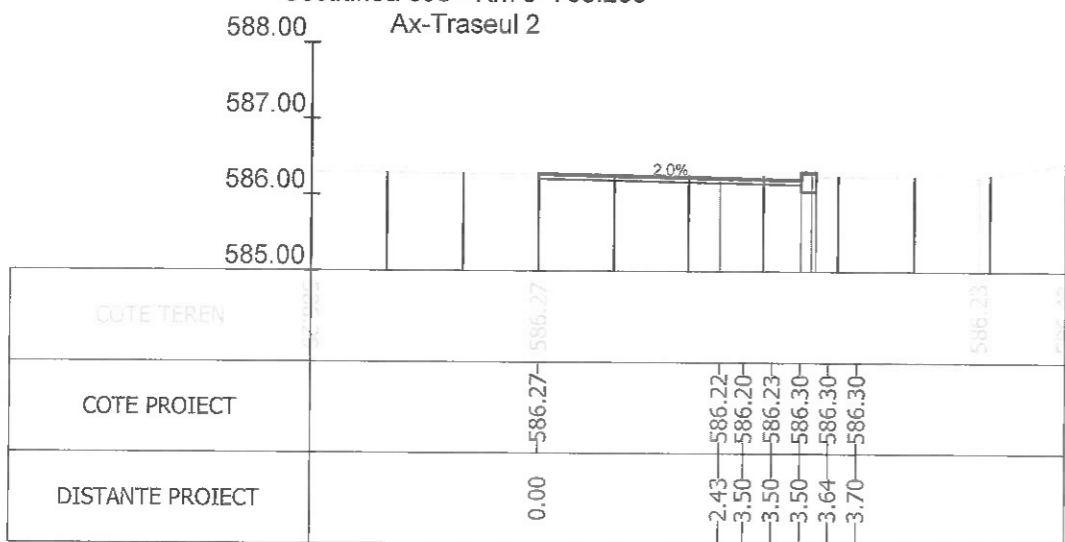

Sectiunea 395 - Km 5+750
Ax-Traseul 2

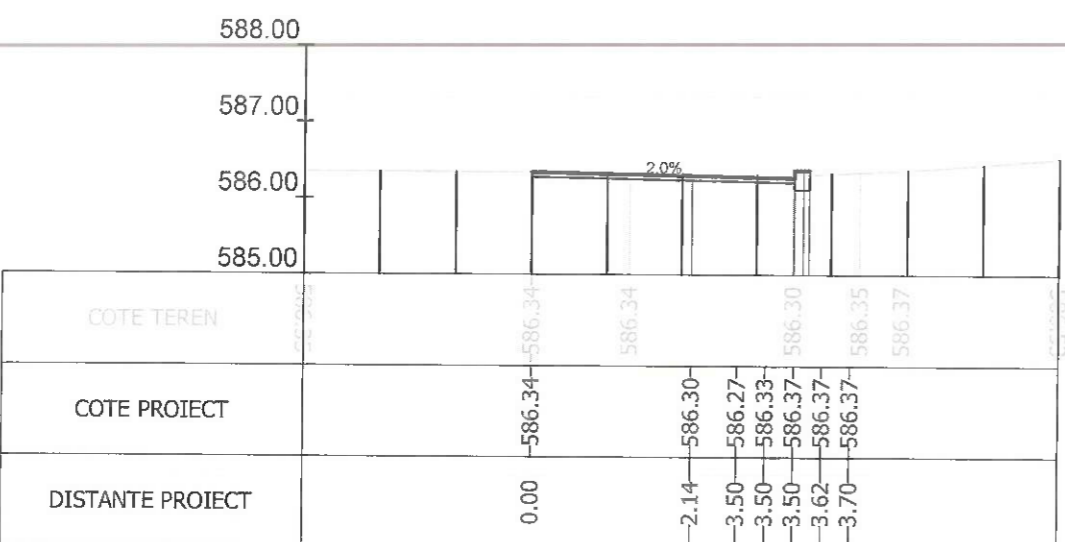

Sectiunea 397 - Km 5+775
Ax-Traseul 2

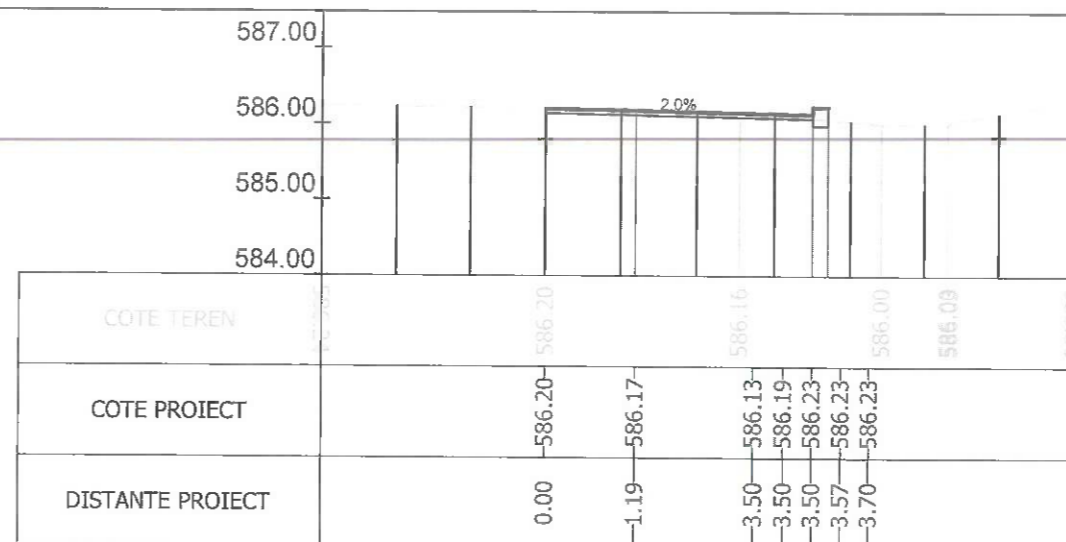

Sectiunea 394 - Km 5+725
Ax-Traseul 2

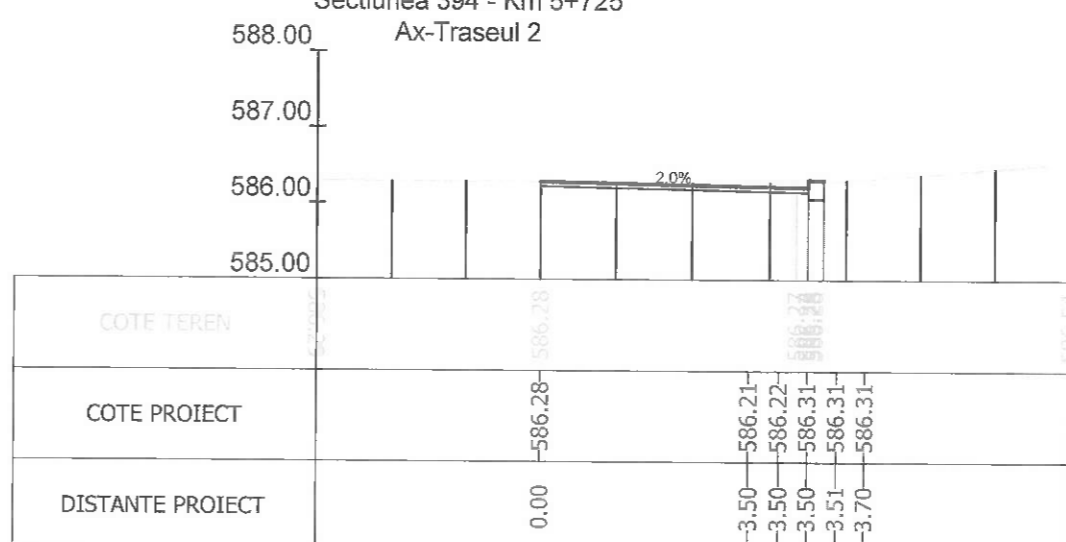

Sectiunea 396 - Km 5+771.282
Ax-Traseul 2

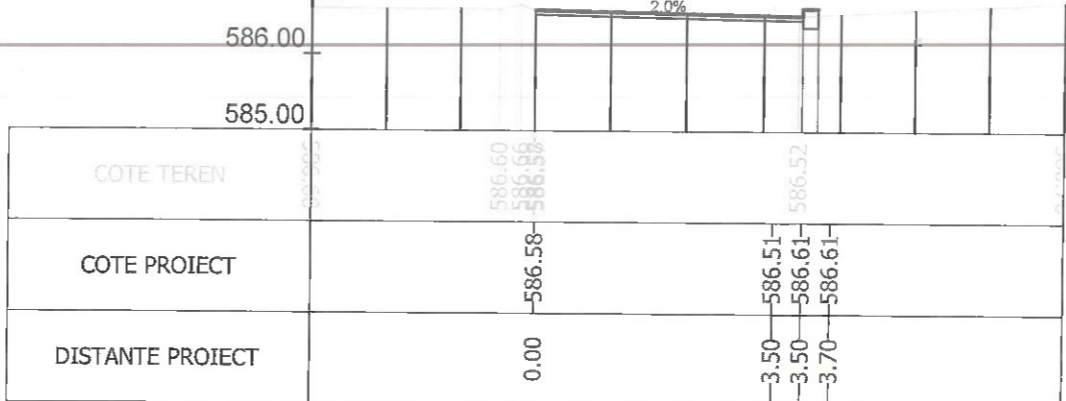

Sectiunea 398 - Km 5+800
Ax-Traseul 2



Index	Data	Observatii	Rev. 5
A			
		Beneficiar:	MUNICIPIUL BRASOV Bulevardul Eroilor 8, Brasov 500007
Sef Proiect: Ing. A. Buta Proiectat: Ing. A. Buta Desenat: Ing. S. Patroi Verificat:		Titlu proiect:	AMENAJARE BENZI DEDICATE TRANSPORTULUI PUBLIC IN MUNICIPIUL BRASOV SI TROTUARE ADIACENTE
Scara: 1/100 Data: 07/2023		Titlu plansa:	PROFILE TRANSVERSALE CURENTE
		Nr. proiect:	73 / 2020
		Faza:	P.T.
		Nr. plansa:	PT-123

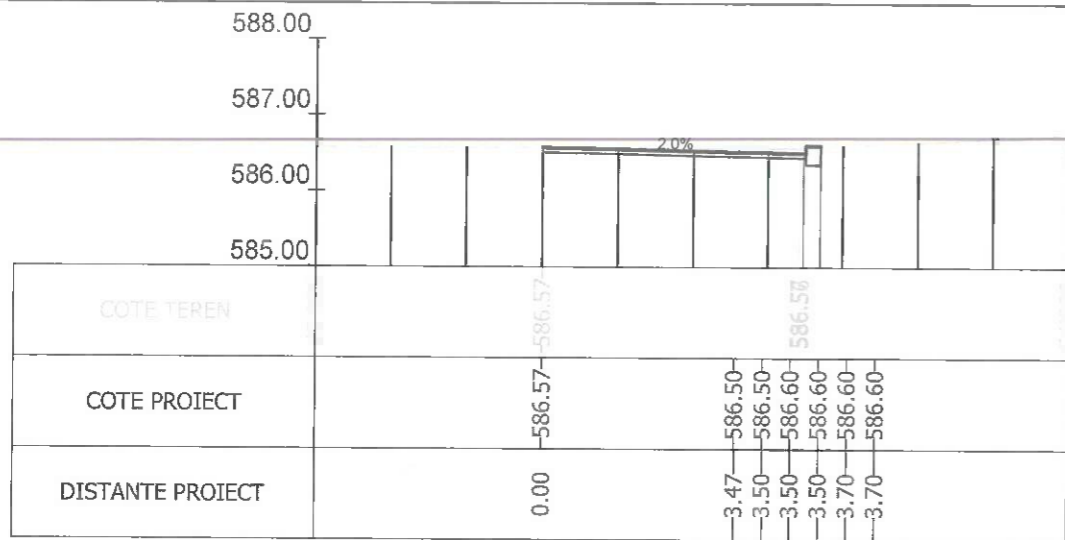

Sectiunea 399 - Km 5+805.792
Ax-Traseul 2

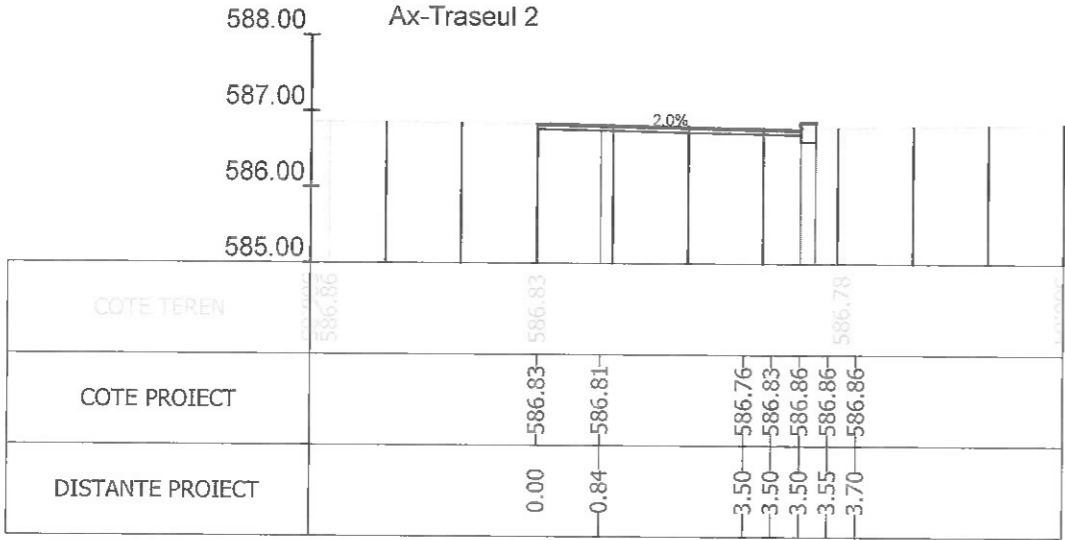

Sectiunea 401 - Km 5+825
Ax-Traseul 2

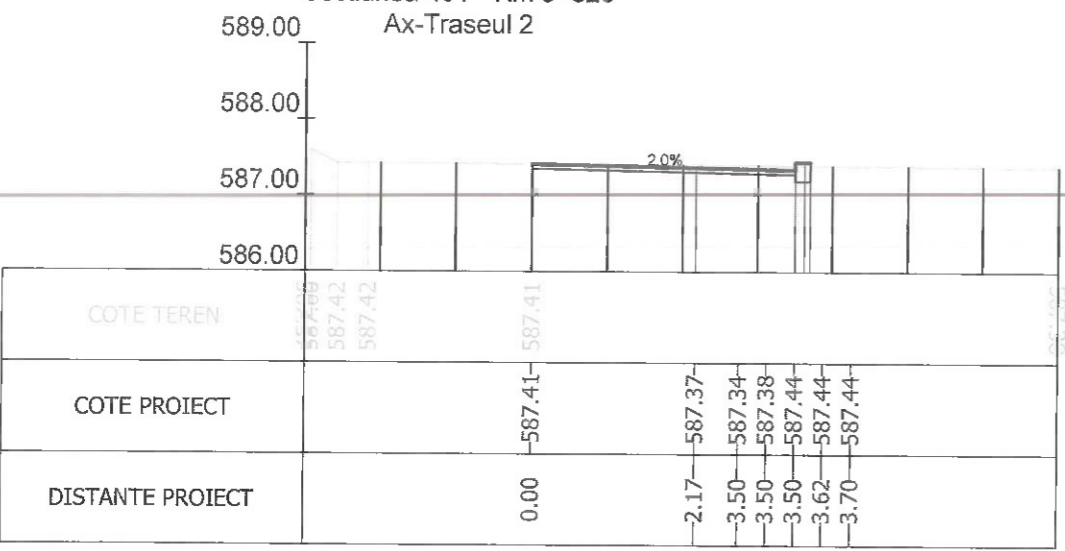

Sectiunea 403 - Km 5+875
Ax-Traseul 2

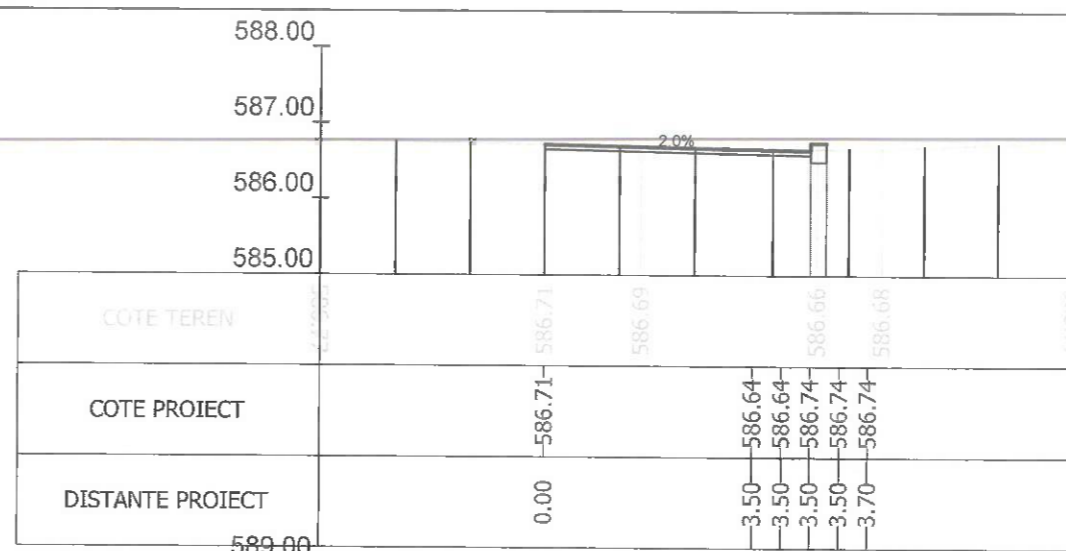

Sectiunea 400 - Km 5+821.197
Ax-Traseul 2

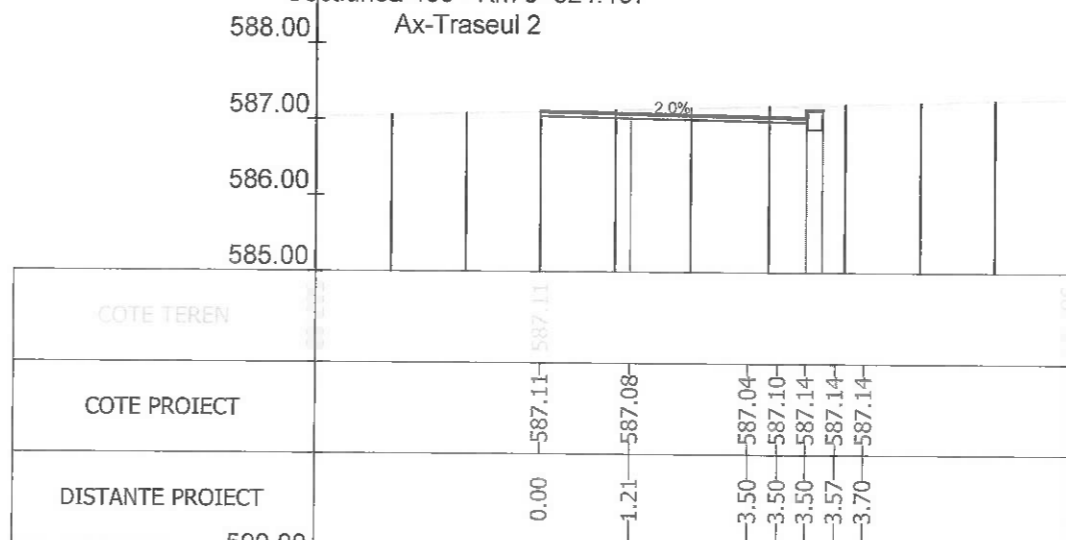

Sectiunea 402 - Km 5+850
Ax-Traseul 2

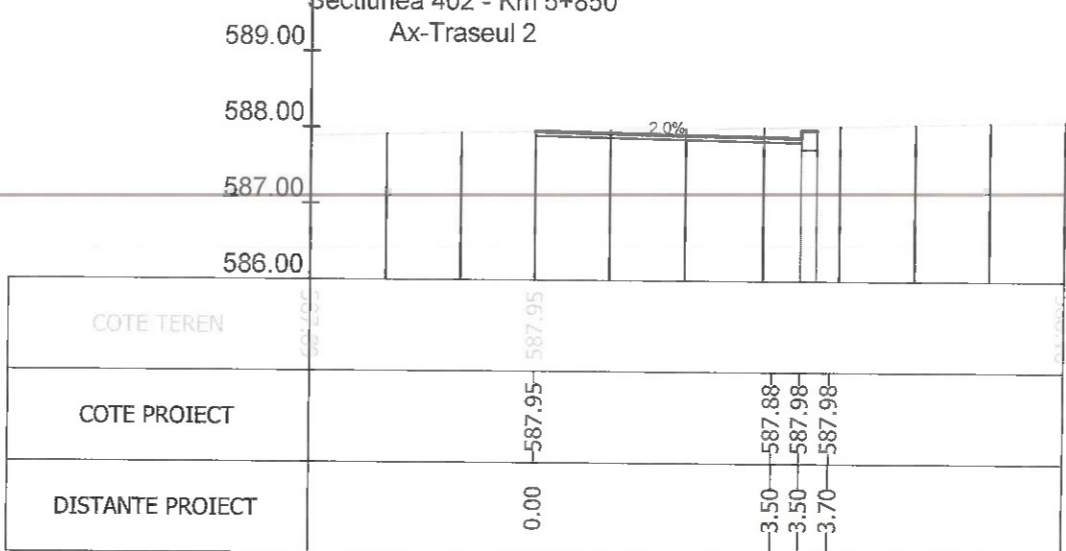

Sectiunea 404 - Km 5+900
Ax-Traseul 2



Index A	Data Ax-Traseul 2	Observatii	Rev. 5
		Beneficiar:	MUNICIPIUL BRASOV Bulevardul Eroilor 8, Brasov 500007
Sef Proiect Ing. A. Buta Proiectat Ing. A. Buta Desenat Ing. S. Patroi Verificat		Scara 1/100 Data 07/2023	Nr. proiect 73 / 2020 Faza P.T. Nr. plansa PT-124
		Titlu proiect: AMENAJARE BENZI DEDICATE TRANSPORTULUI PUBLIC IN MUNICIPIUL BRASOV SI TROTUARE ADIACENTE	
		Titlu plansa: PROFILE TRANSVERSALE CURENTE	

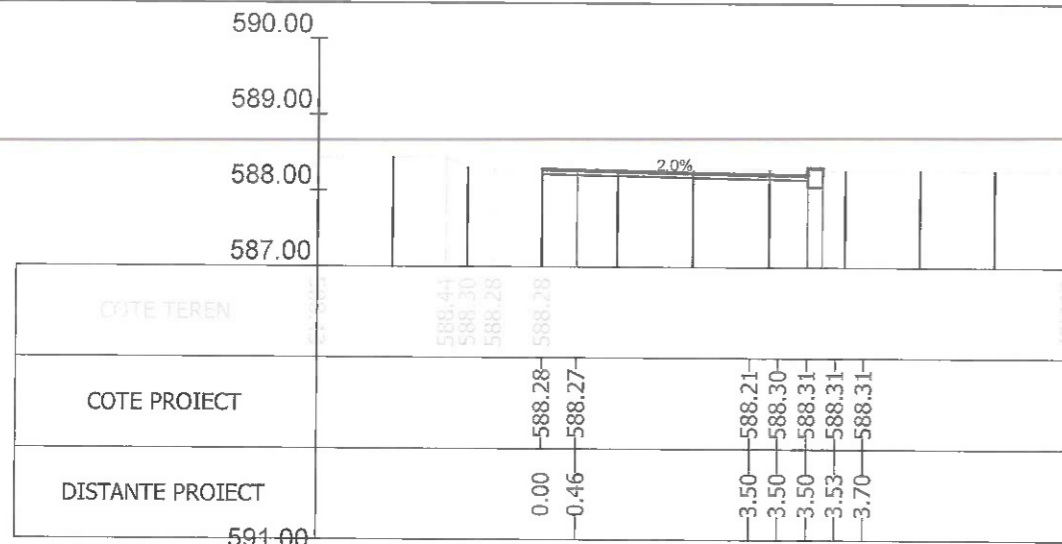

Sectiunea 405 - Km 5+925
Ax-Traseul 2

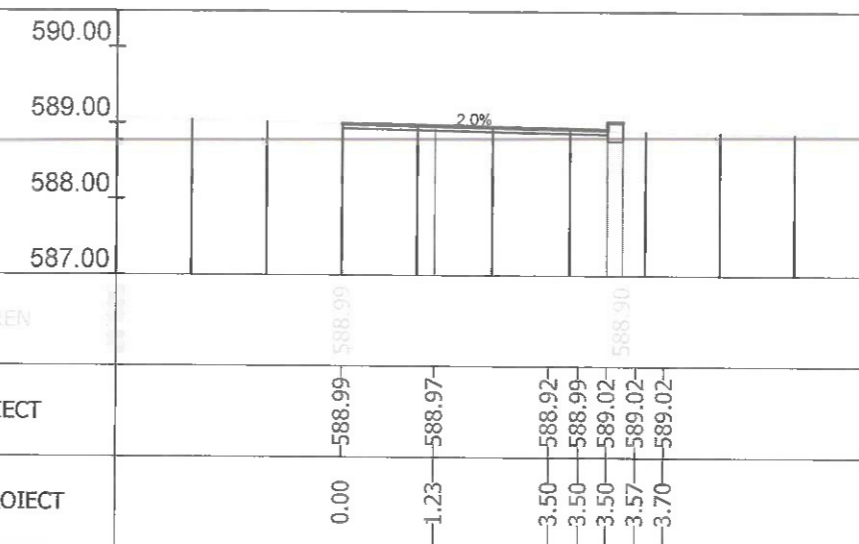
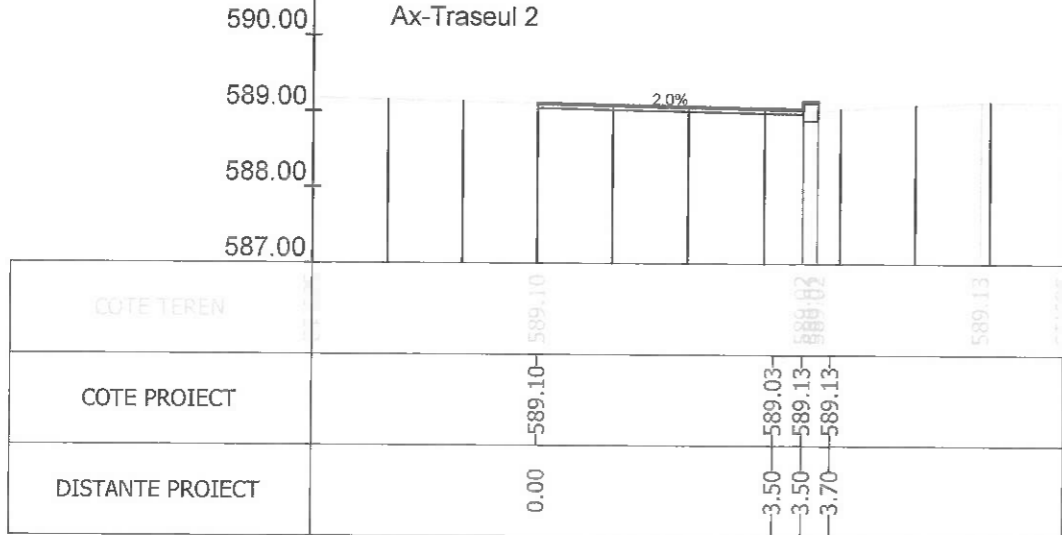

Sectiunea 406 - Km 5+950
Ax-Traseul 2

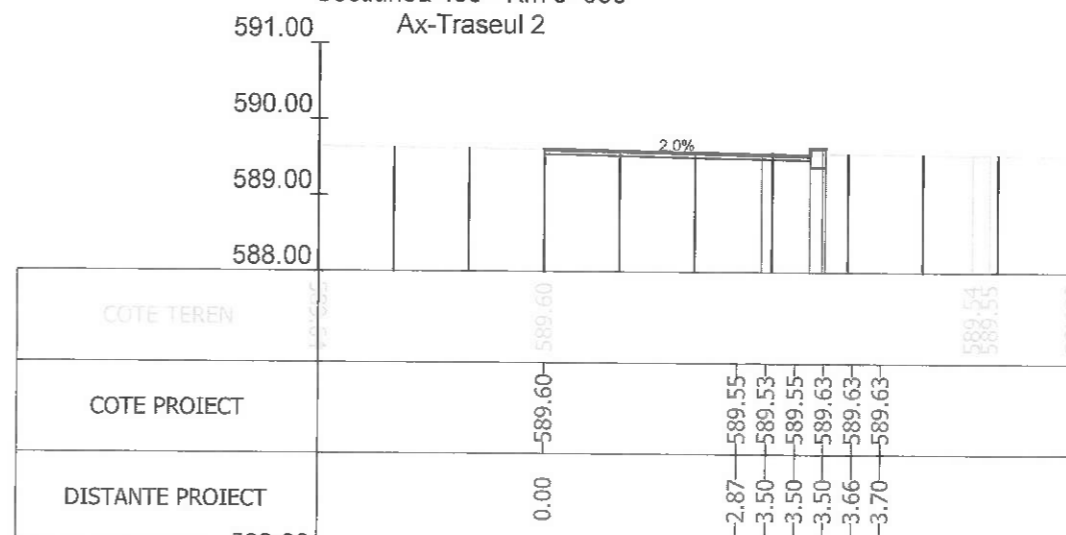

Sectiunea 407 - Km 5+954.793
Ax-Traseul 2

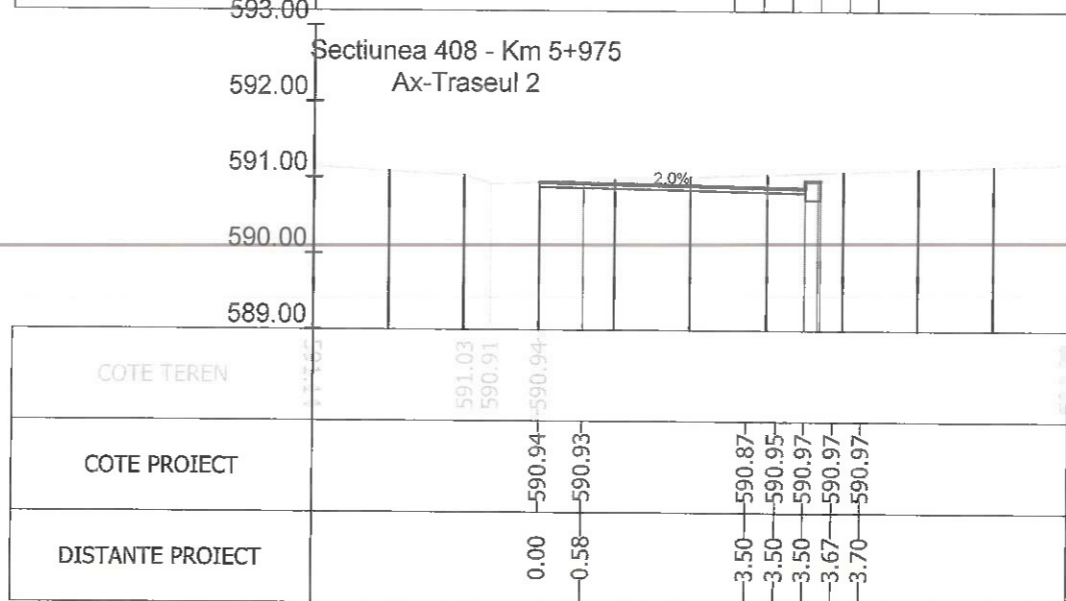

Sectiunea 408 - Km 5+975
Ax-Traseul 2

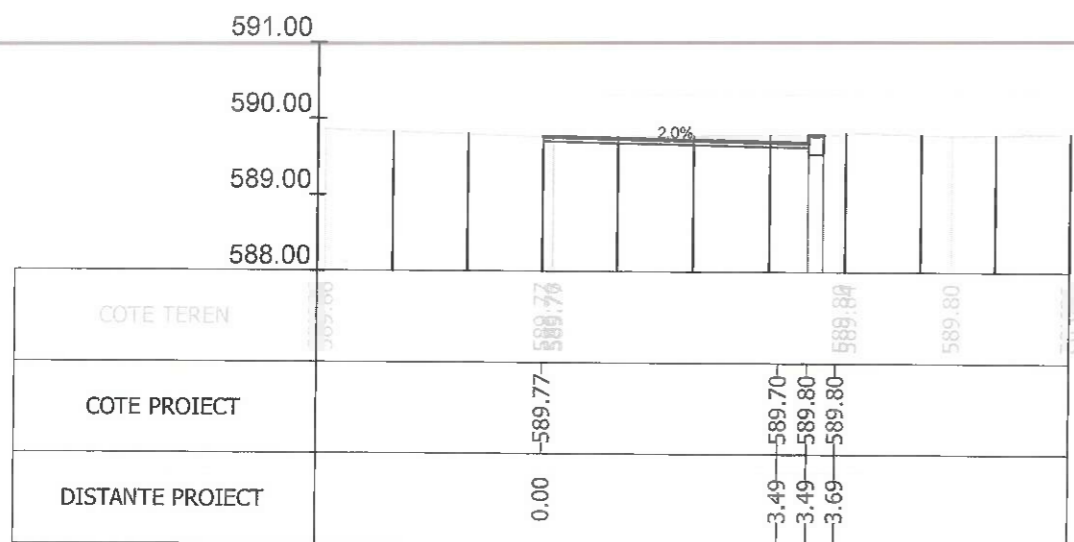

Sectiunea 409 - Km 5+991.911
Ax-Traseul 2

Index		Data Observatii		Rev. 5
A				
		Beneficiar:		MUNICIPIUL BRASOV Bulevardul Eroilor 8, Brasov 500007
Sef Proiect	Ing. A. Buta	Titlu proiect:		AMENAJARE BENZI DEDICATE TRANSPORTULUI PUBLIC IN MUNICIPIUL BRASOV SI TROTUARE ADIACENTE
Proiectat	Ing. A. Buta	Titlu plansa:		PROFILE TRANSVERSALE CURENTE
Desenat	Ing. S. Patroi	Scara	1/100	
Verificat		Data	07/2023	
		Nr. proiect	73 / 2020	
		Faza	P.T.	
		Nr. plansa	PT-125	



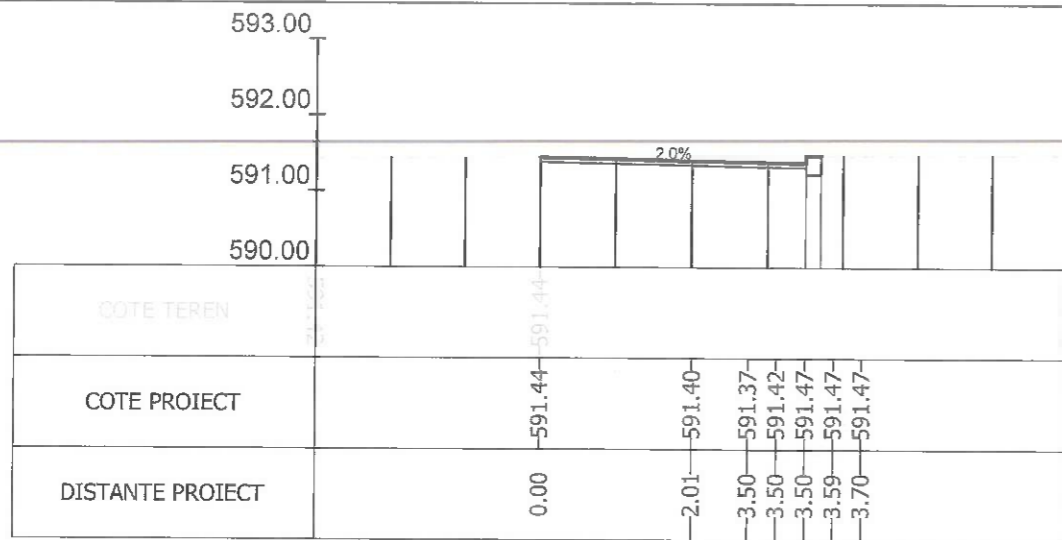

Sectiunea 414 - Km 6+075
Ax-Traseul 2

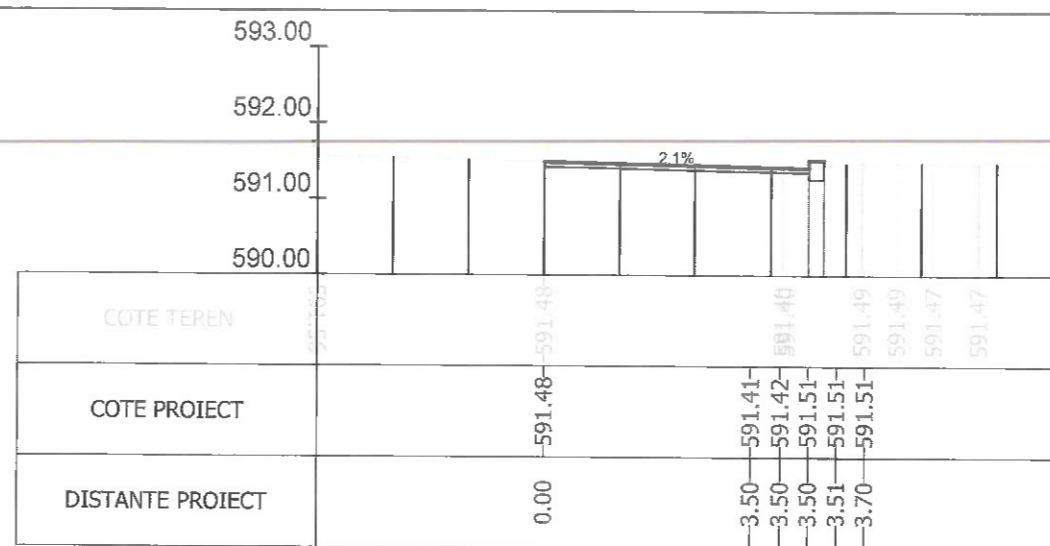

Sectiunea 415 - Km 6+088.821
Ax-Traseul 2

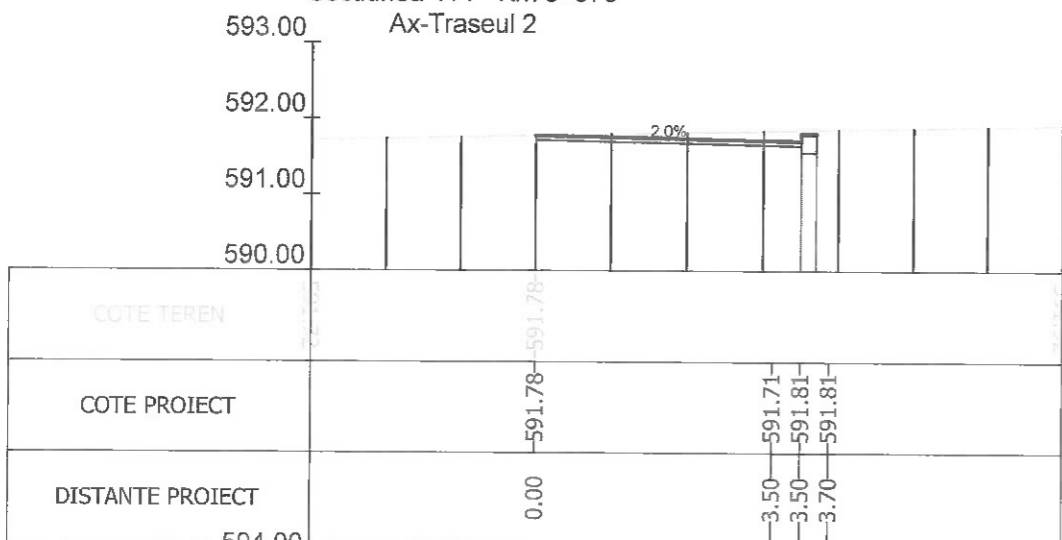

Sectiunea 416 - Km 6+100
Ax-Traseul 2

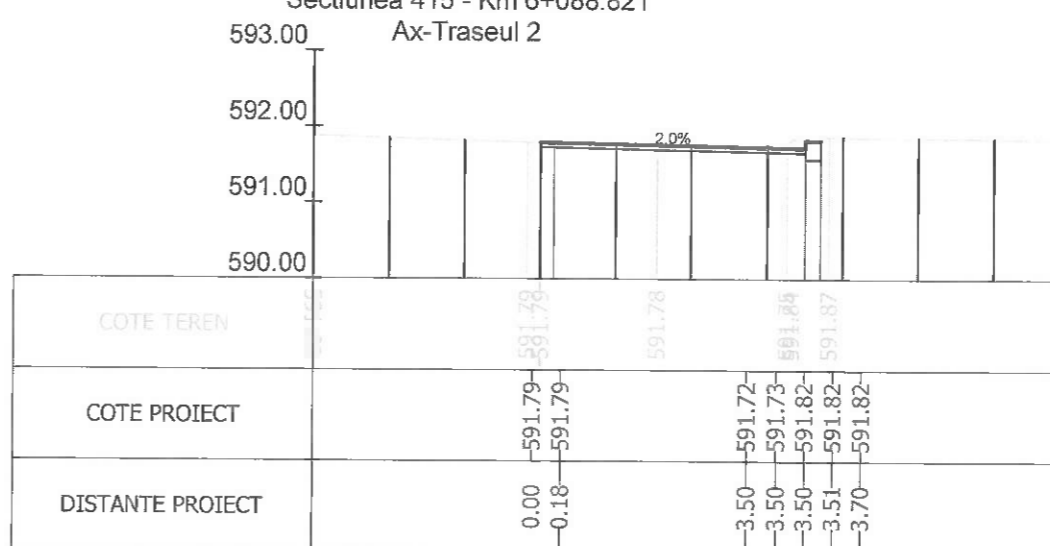

Sectiunea 417 - Km 6+125
Ax-Traseul 2

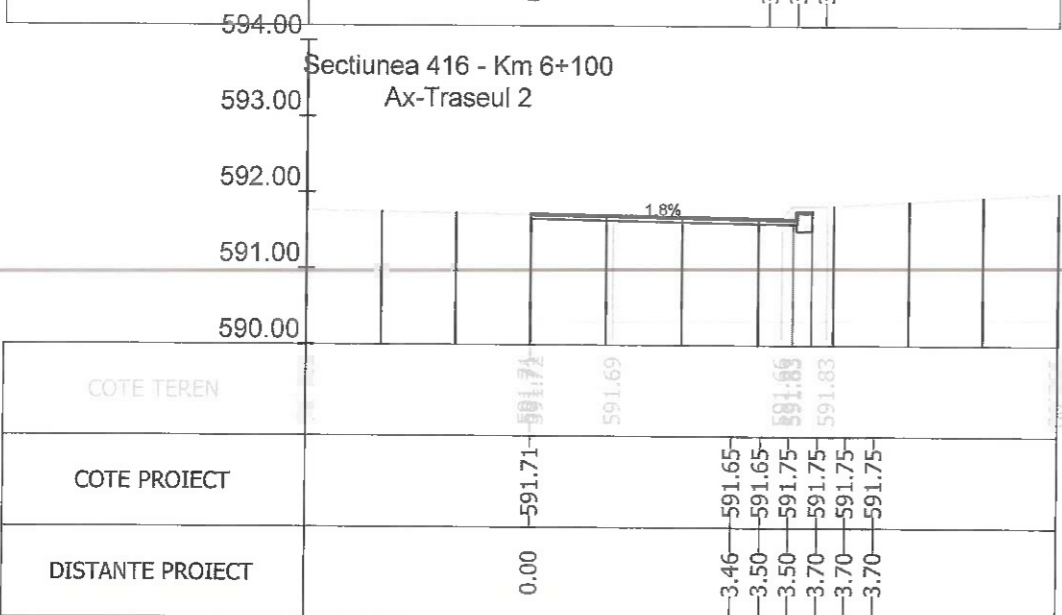

Sectiunea 418 - Km 6+128.230
Ax-Traseul 2

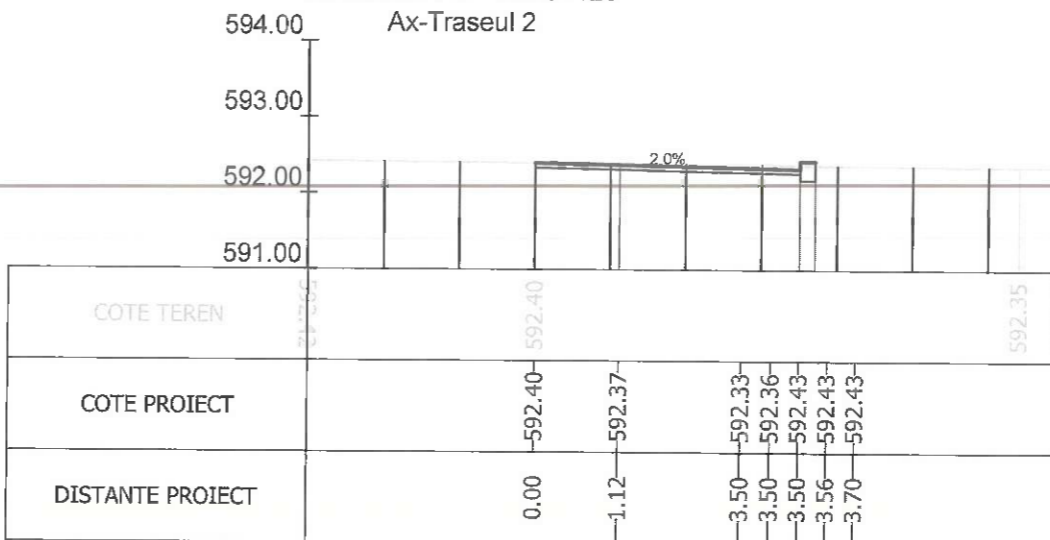

Sectiunea 419 - Km 6+150
Ax-Traseul 2



Index	A		Rev. 5
			Beneficiar: MUNICIPIUL BRASOV Bulevardul Eroilor 8, Brasov 500007
Sef Proiect	Ing. A. Buta		Nr. proiect: 73 / 2020
Proiectat	Ing. A. Buta		Faza P.T.
Desenat	Ing. S. Patroi		Nr. plansa: PT-126
Verificat			
Scara 1/100			Titlu proiect: AMENAJARE BENZI DEDICATE TRANSPORTULUI PUBLIC IN MUNICIPIUL BRASOV SI TROTUARE ADIACENTE
Data 07/2023			Titlu plansa: PROFILE TRANSVERSALE CURENTE

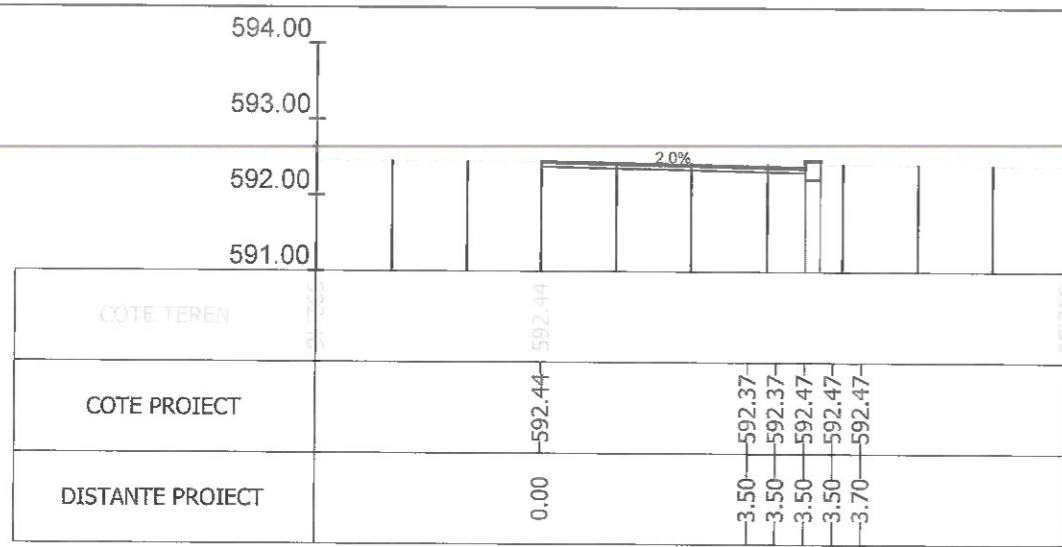

Sectiunea 420 - Km 6+152.423
Ax-Traceul 2

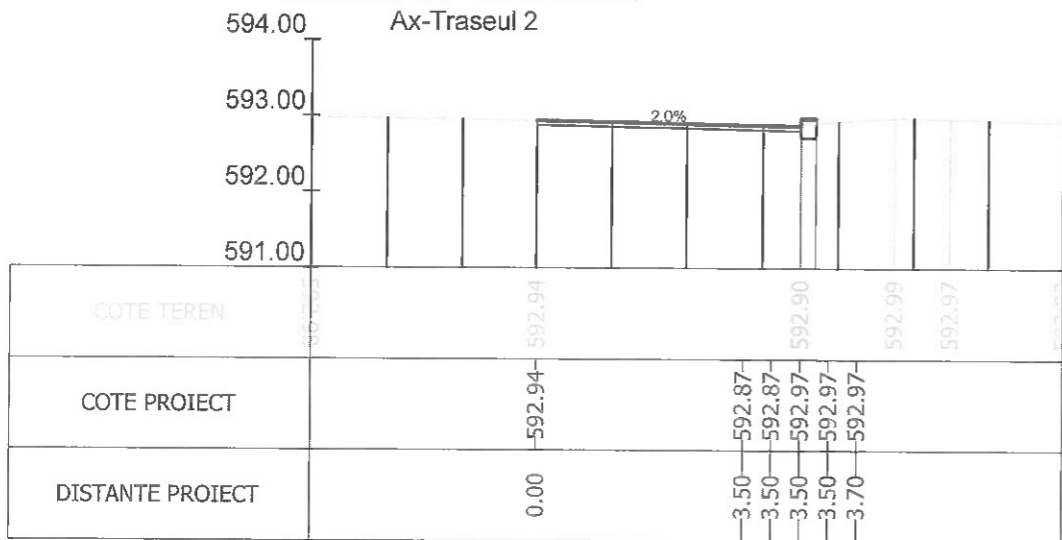

Sectiunea 422 - Km 6+192.447
Ax-Traceul 2

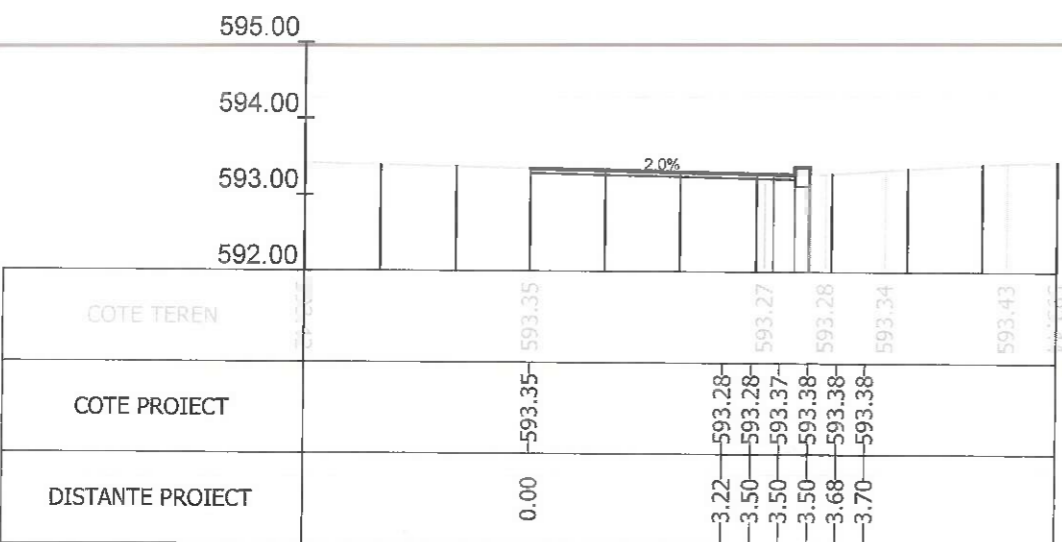

Sectiunea 424 - Km 6+218.755
Ax-Traceul 2

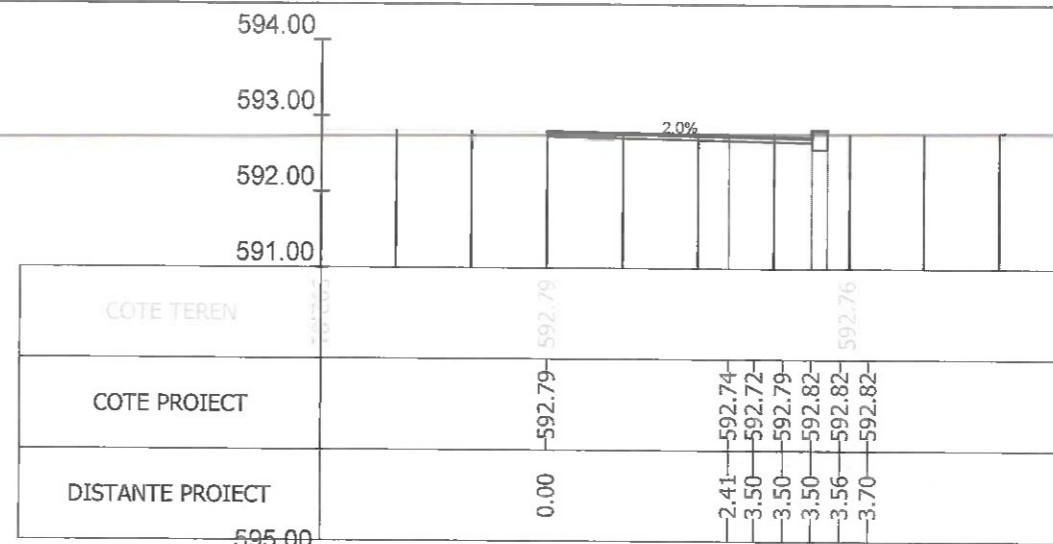

Sectiunea 421 - Km 6+175
Ax-Traceul 2

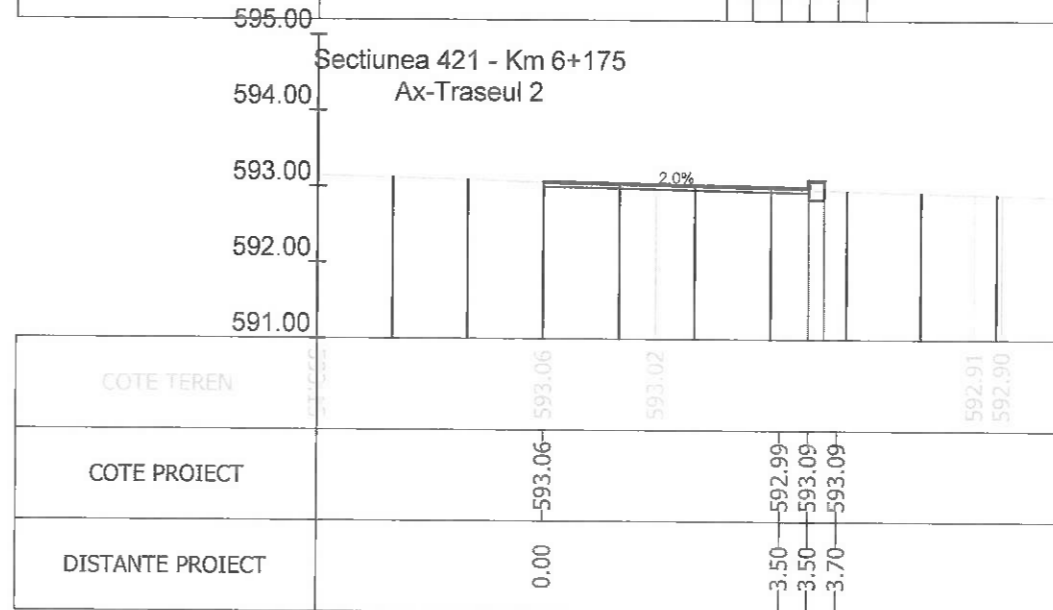

Sectiunea 423 - Km 6+200
Ax-Traceul 2

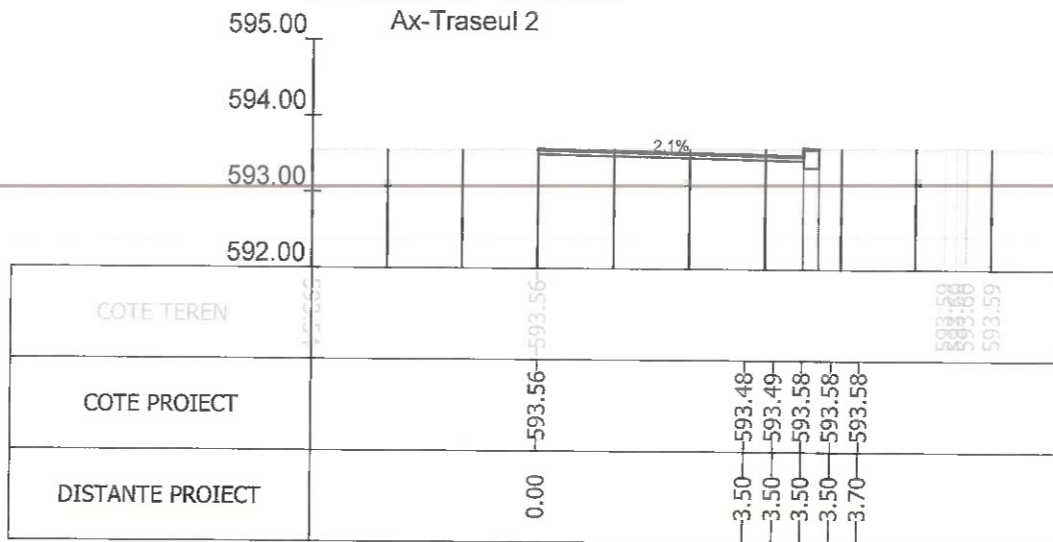

Sectiunea 425 - Km 6+223.775
Ax-Traceul 2



Index	Data	Observatii	Rev. 5
A			
		Beneficiar:	MUNICIPIUL BRASOV Bulevardul Eroilor 8, Brasov 500007
Sef Proiect: Ing. A. Buta Proiectat: Ing. A. Buta Desenat: Ing. S. Patroi Verificat:		Titlu proiect:	AMENAJARE BENZI DEDICATE TRANSPORTULUI PUBLIC IN MUNICIPIUL BRASOV SI TROTUARE ADIACENTE
Scara: 1/100		Titlu plansa:	PROFILE TRANSVERSALE CURENTE
Data: 07/2023		Nr. proiect:	73 / 2020
		Faza:	P.T.
		Nr. plansa:	PT-127

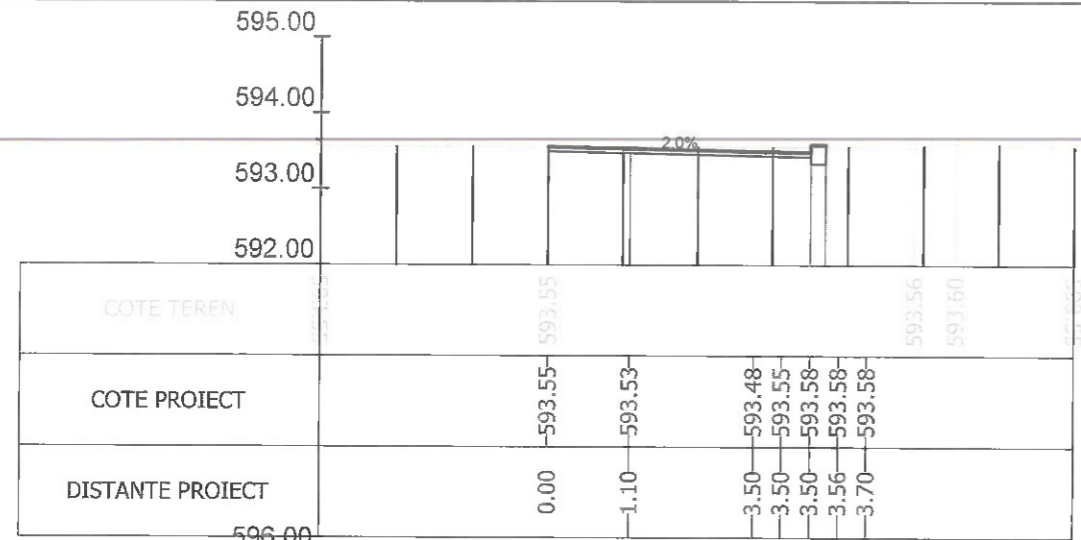

Sectiunea 426 - Km 6+225
Ax-Traseul 2

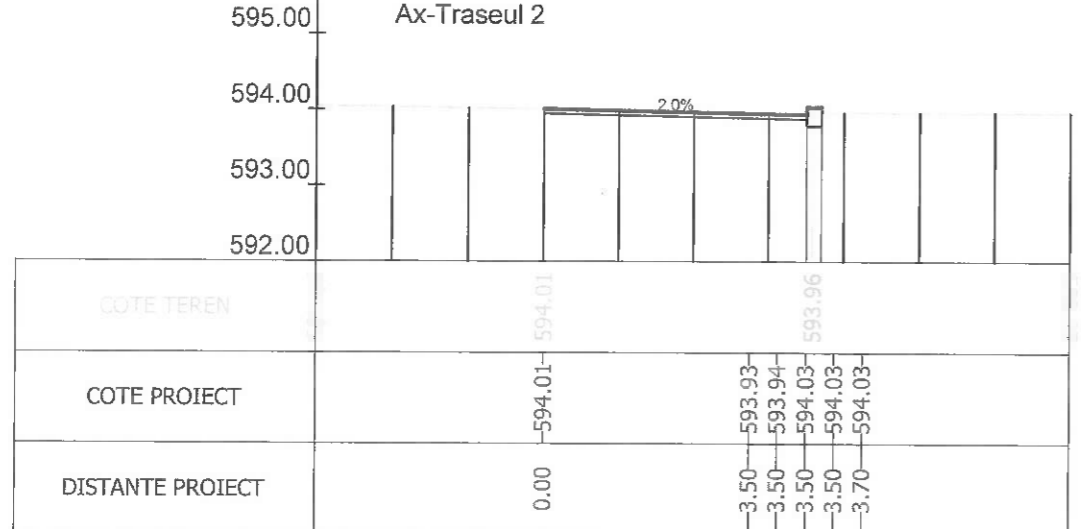

Sectiunea 428 - Km 6+270.412
Ax-Traseul 2

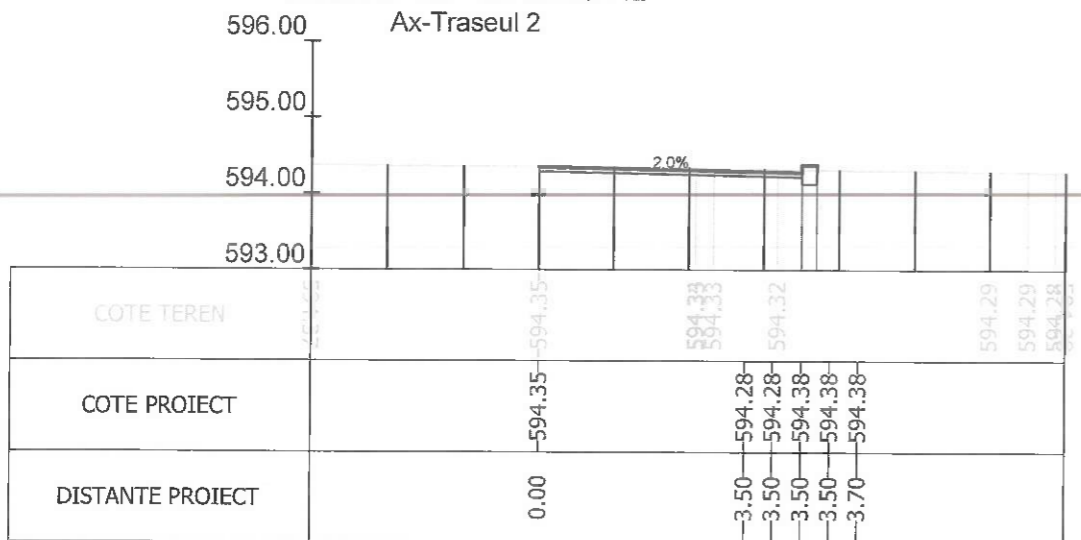

Sectiunea 430 - Km 6+296.849
Ax-Traseul 2

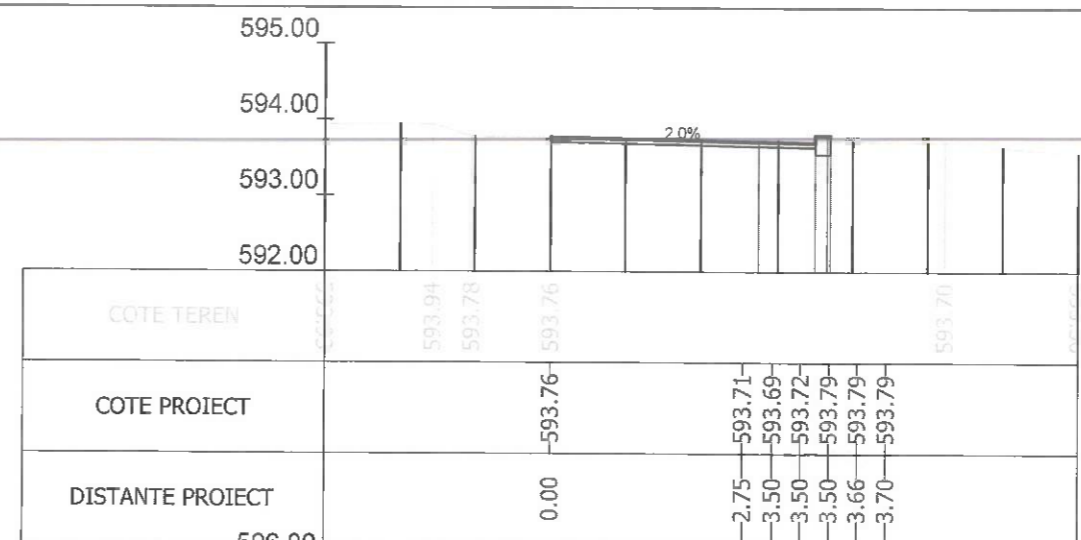

Sectiunea 427 - Km 6+250
Ax-Traseul 2

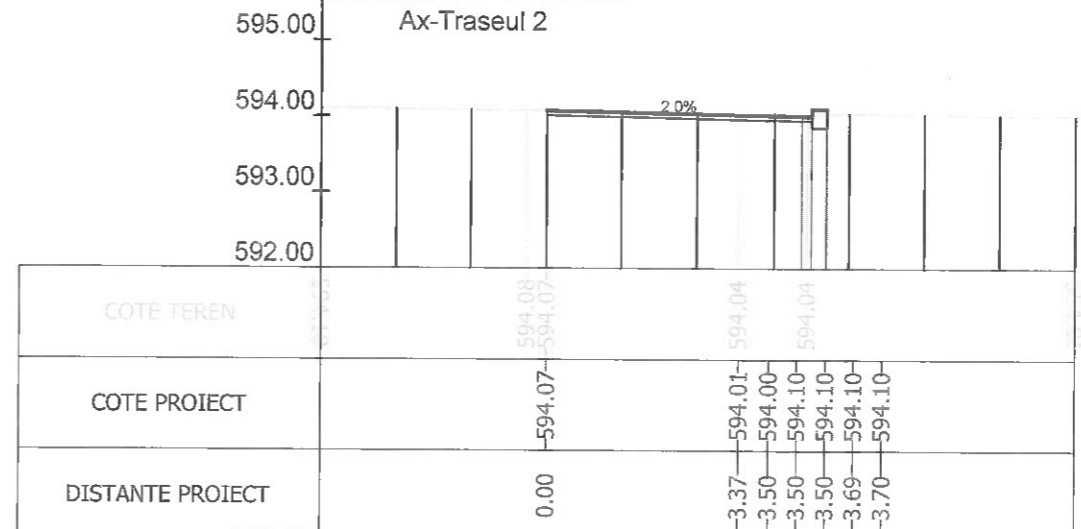

Sectiunea 429 - Km 6+275
Ax-Traseul 2

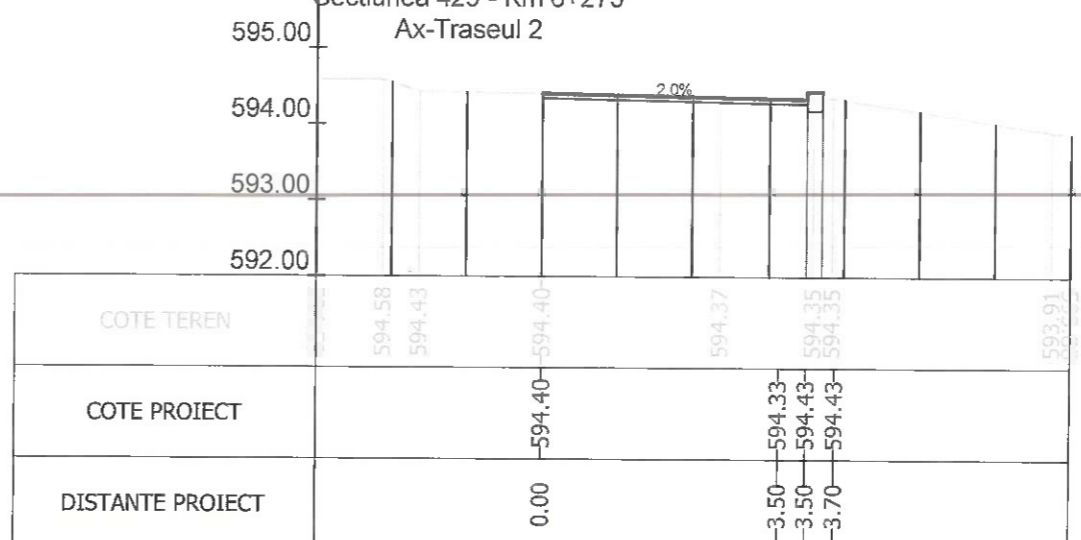

Sectiunea 431 - Km 6+300
Ax-Traseul 2



Index A	Data 07/2023	Rev. 5
		Beneficiar: MUNICIPIUL BRASOV Bulevardul Eroilor 8, Brasov 500007
Sef Proiect: Ing. A. Buta Proiectat: Ing. A. Buta Desenat: Ing. S. Patroi Verificat:		Nr. proiect: 73 / 2020 Faza: P.T. Nr. plansa: PT-128
Scara: 1/100 Data: 07/2023		Titlu proiect: AMENAJARE BENZI DEDICATE TRANSPORTULUI PUBLIC IN MUNICIPIUL BRASOV SI TROTUARE ADIACENTE Titlu plansa: PROFILE TRANSVERSALE CURENTE

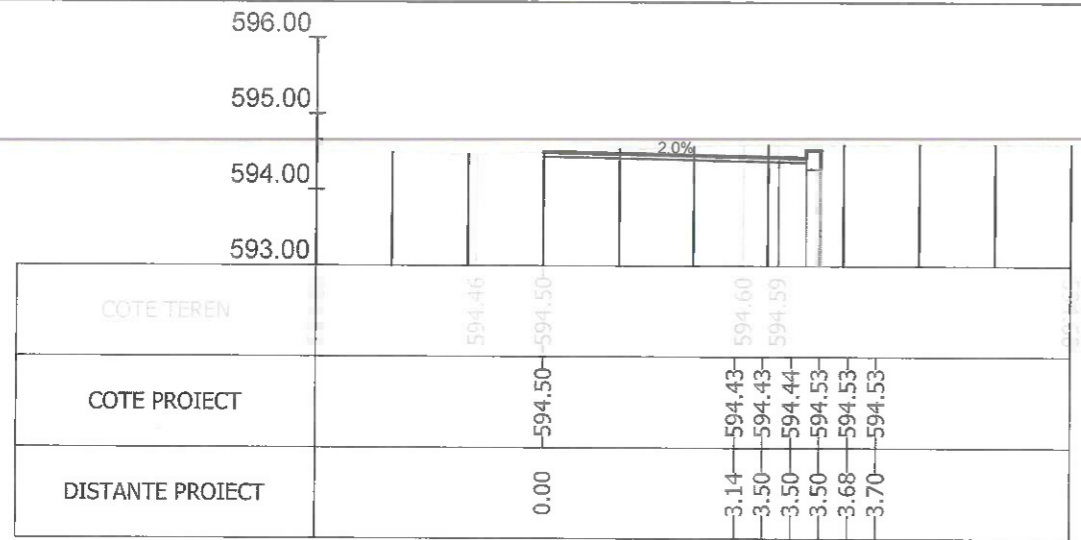

Sectiunea 432 - Km 6+325
Ax-Traseul 2

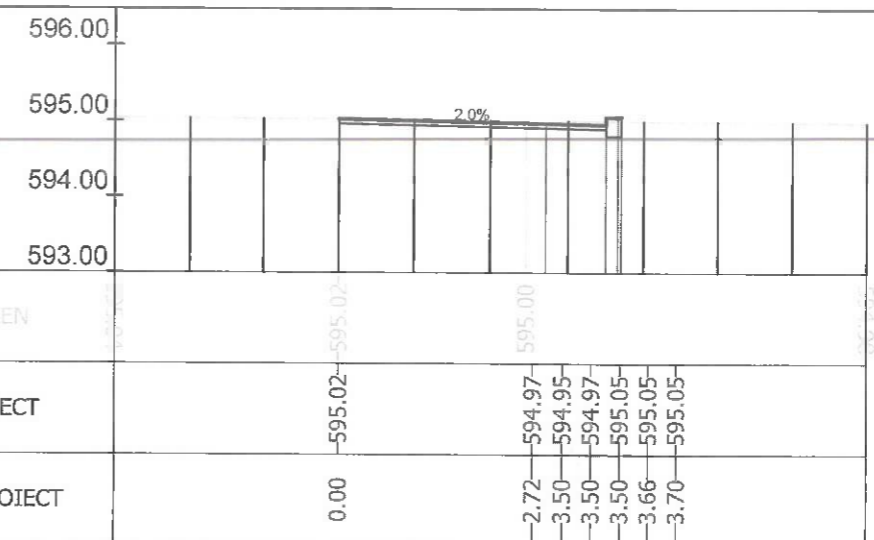
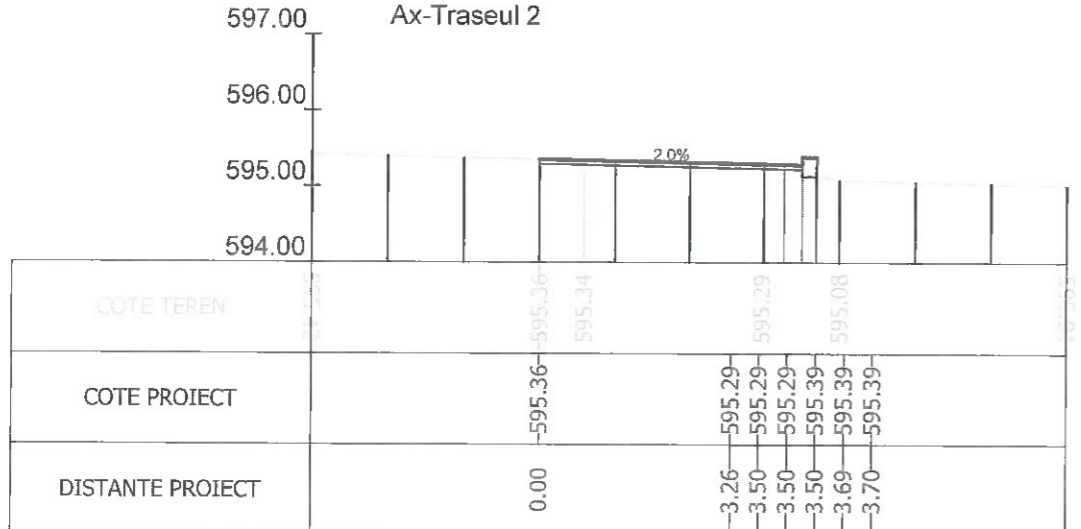

Sectiunea 433 - Km 6+350
Ax-Traseul 2

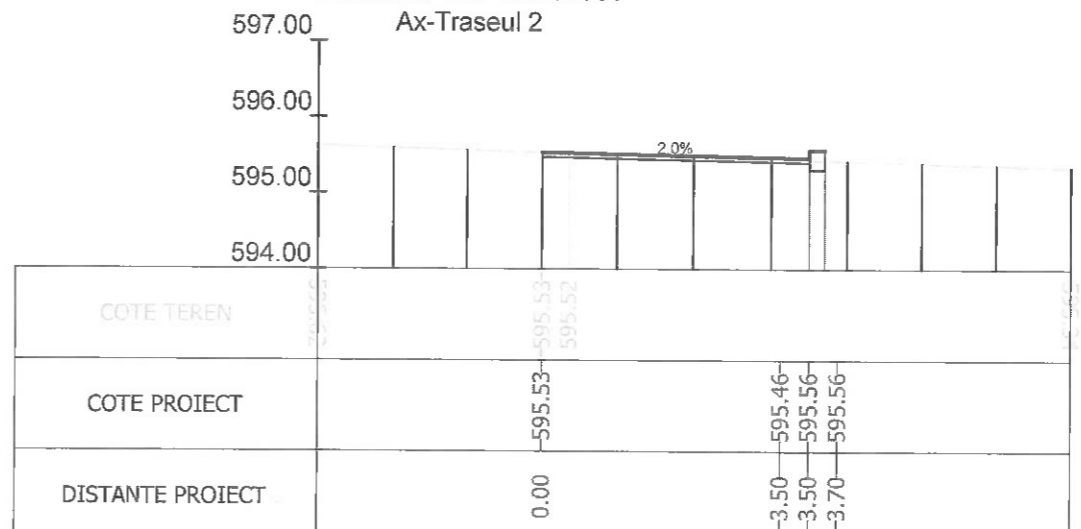

Sectiunea 434 - Km 6+375
Ax-Traseul 2

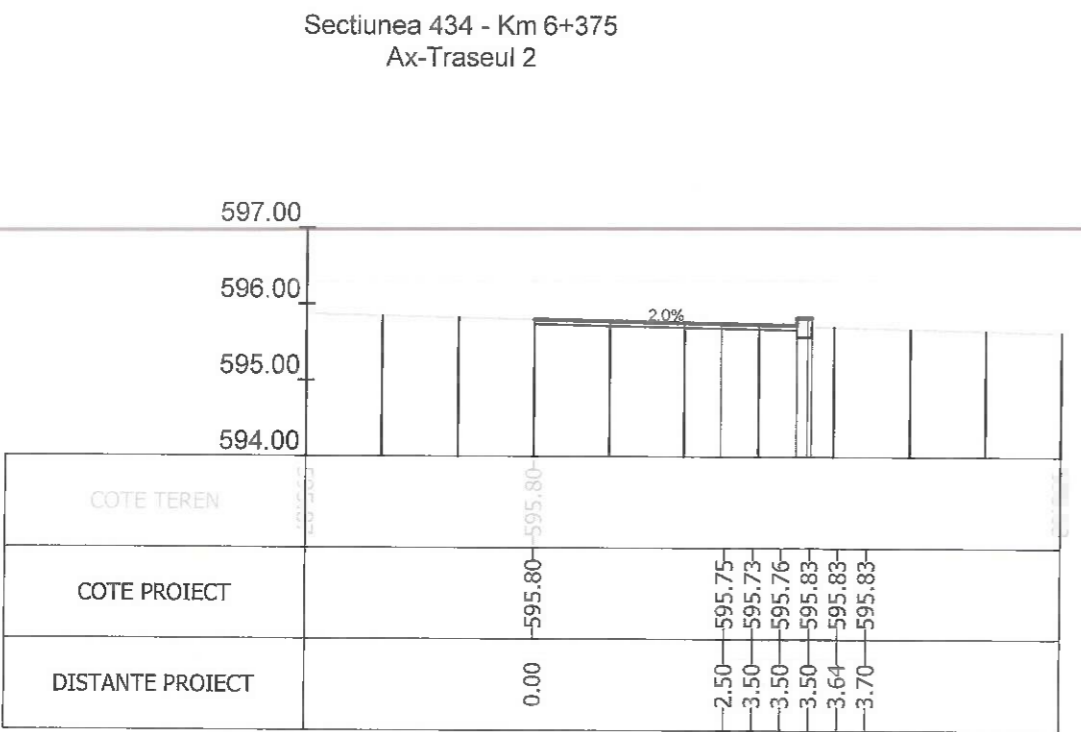

Sectiunea 436 - Km 6+425
Ax-Traseul 2

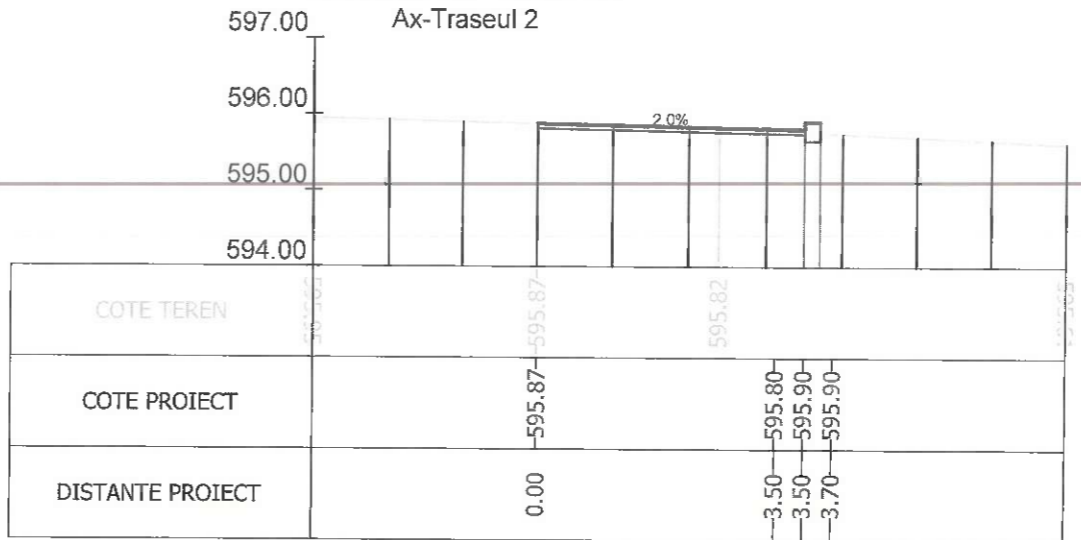

Sectiunea 437 - Km 6+437.558
Ax-Traseul 2

Sectiunea 436 - Km 6+425
Ax-Traseul 2



Index	Data	Rev. 5
A		
		Beneficiar: MUNICIPIUL BRASOV Bulevardul Eroilor 8, Brasov 500007
Sef Proiect	Ing. A. Buta	Nr. proiect: 73 / 2020
Proiectat	Ing. A. Buta	Titlu proiect: AMENAJARE BENZI DEDICATE TRANSPORTULUI PUBLIC IN MUNICIPIUL BRASOV SI TROTUARE ADIACENTE
Desenat	Ing. S. Patroi	Faza P.T.
Verificat		Titlu plansa: PROFILE TRANSVERSALE CURENTE
		Nr. plansa: PT-129
	Scara 1/100	
	Data 07/2023	

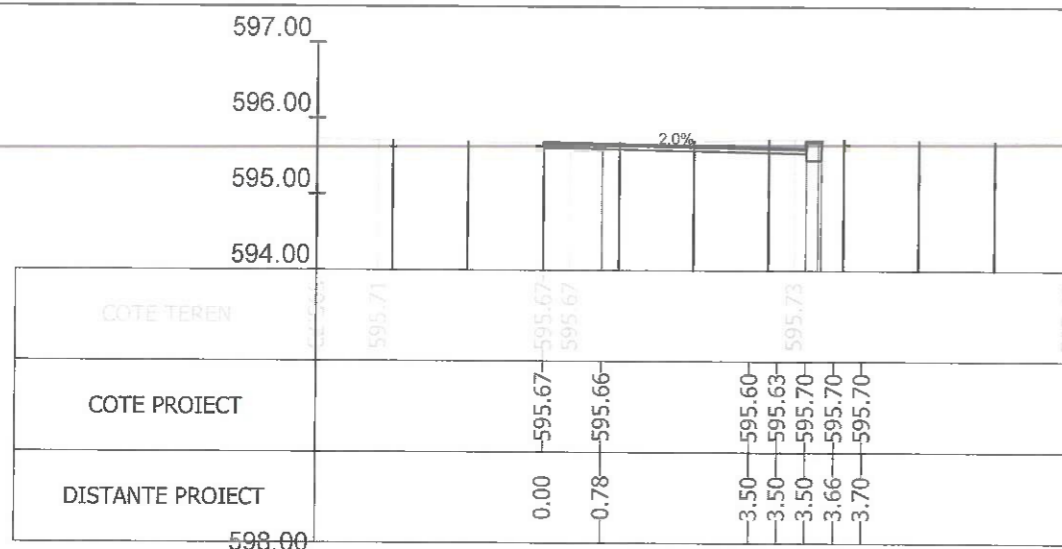

Sectiunea 438 - Km 6+450
Ax-Traseul 2

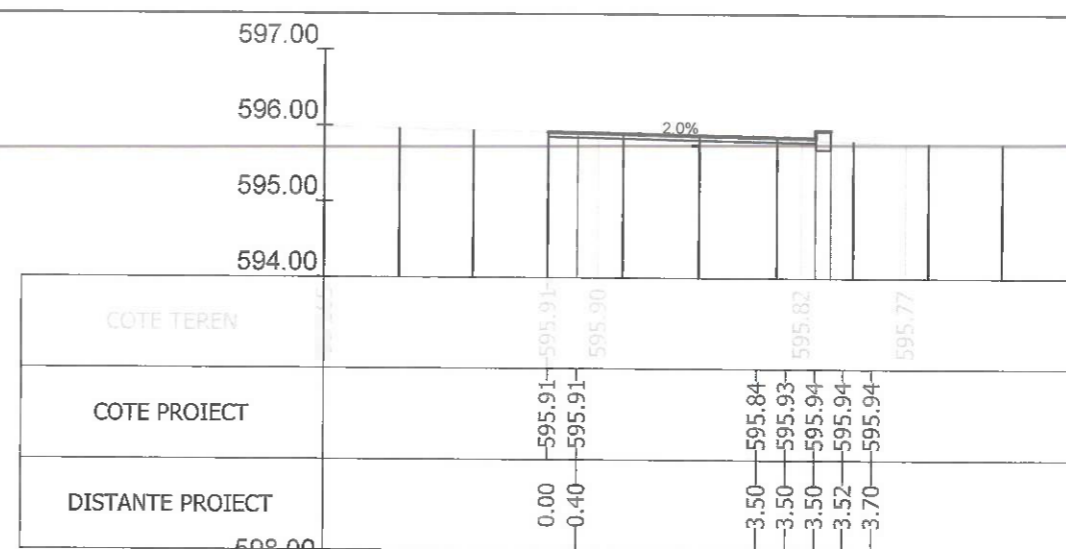

Sectiunea 439 - Km 6+475
Ax-Traseul 2

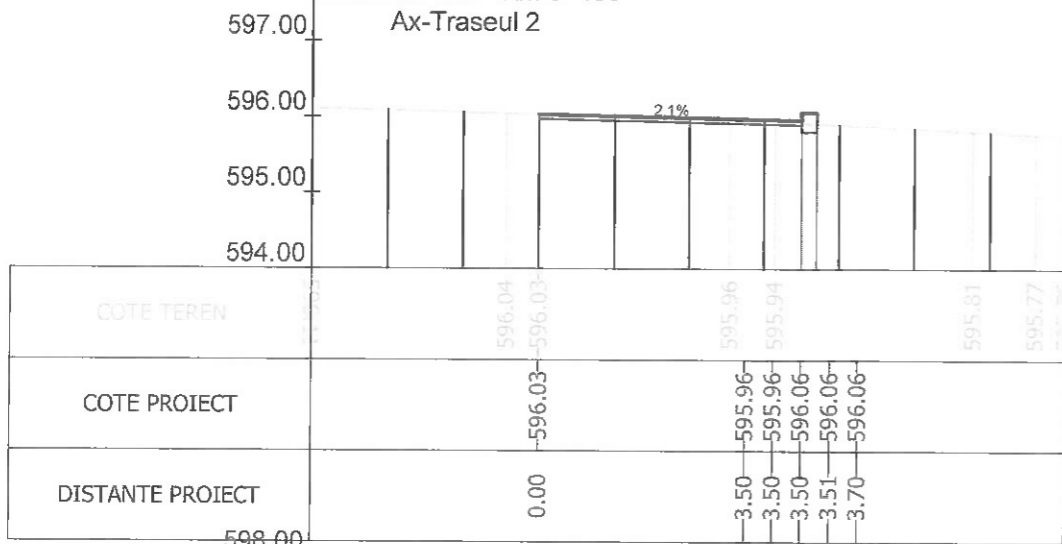

Sectiunea 440 - Km 6+477.457
Ax-Traseul 2

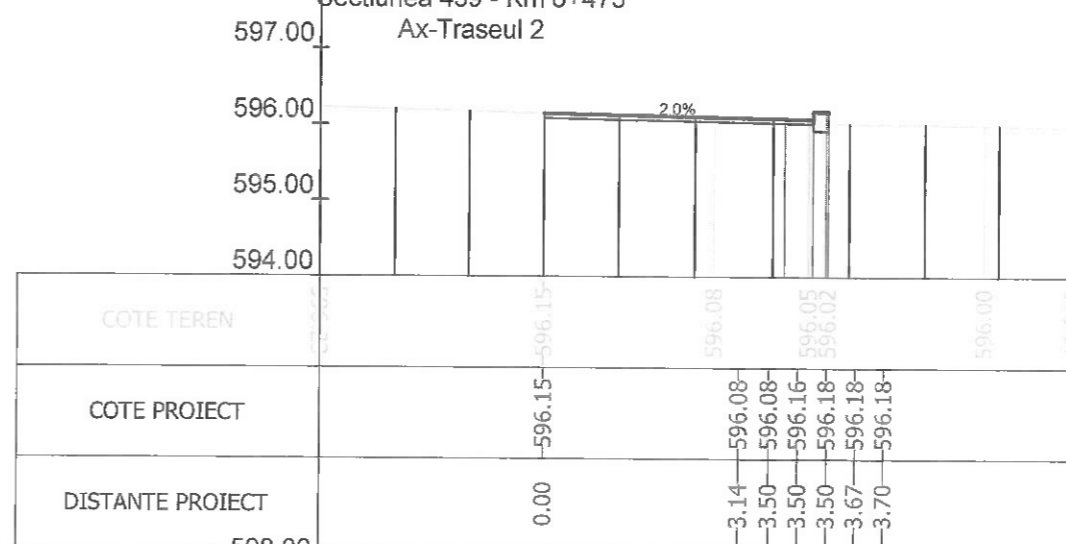

Sectiunea 441 - Km 6+493.831
Ax-Traseul 2

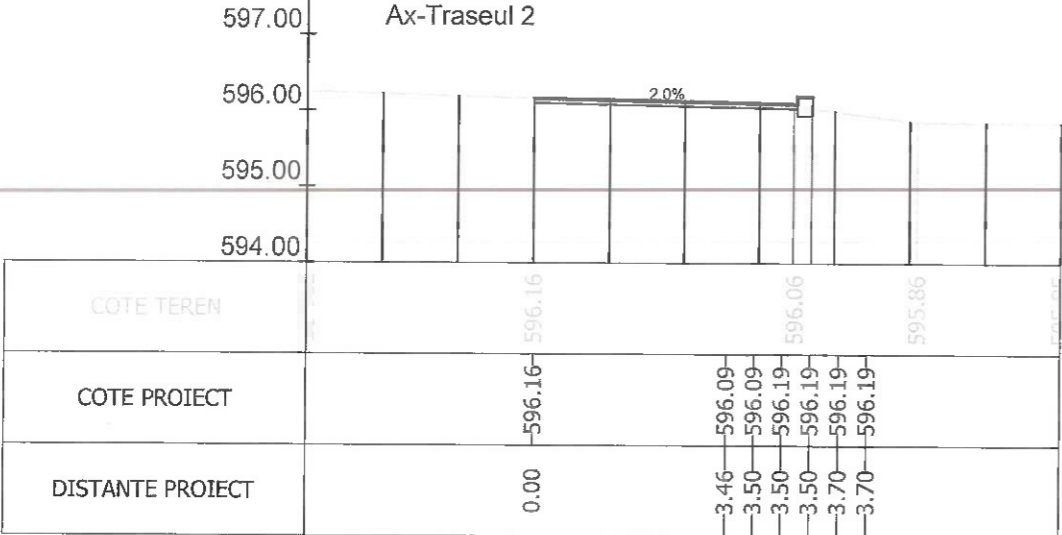

Sectiunea 442 - Km 6+499.022
Ax-Traseul 2

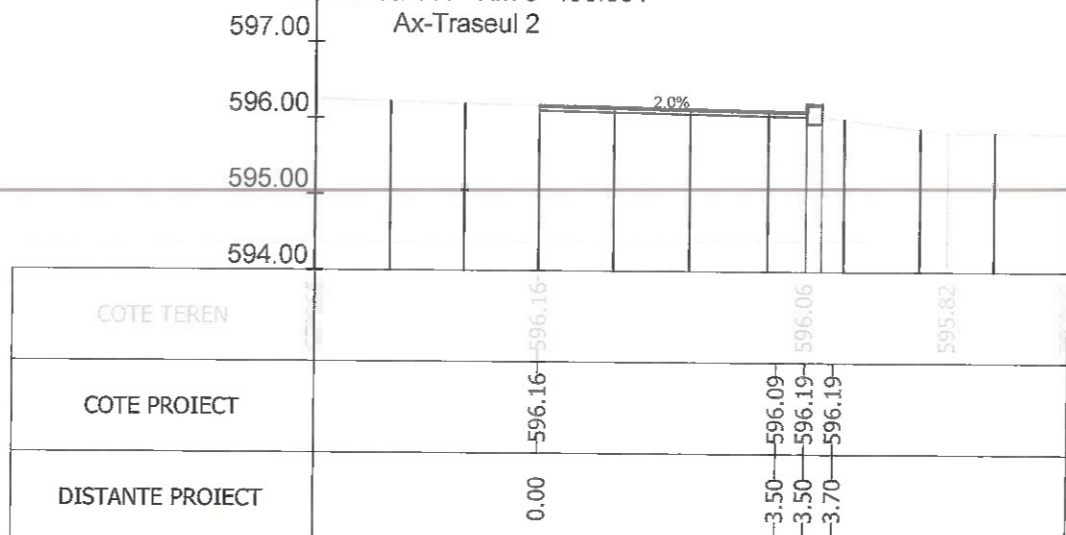

Sectiunea 443 - Km 6+500
Ax-Traseul 2



Index	A		Rev. 5
Beneficiar:	MUNICIPIUL BRASOV Bulevardul Eroilor 8, Brasov 500007		Nr. proiect 73 / 2020
Titlu proiect:	AMENAJARE BENZI DEDICATE TRANSPORTULUI PUBLIC IN MUNICIPIUL BRASOV SI TROTUARE ADIACENTE		Faza P.T.
Titlu planşa:	PROFILE TRANSVERSALE CURENTE		Nr. planşa PT-130
Sef Proiect	Ing. A. Buta	Scara	1/100
Proiectat	Ing. A. Buta	Data	07/2023
Desenat	Ing. S. Patroi		
Verificat			

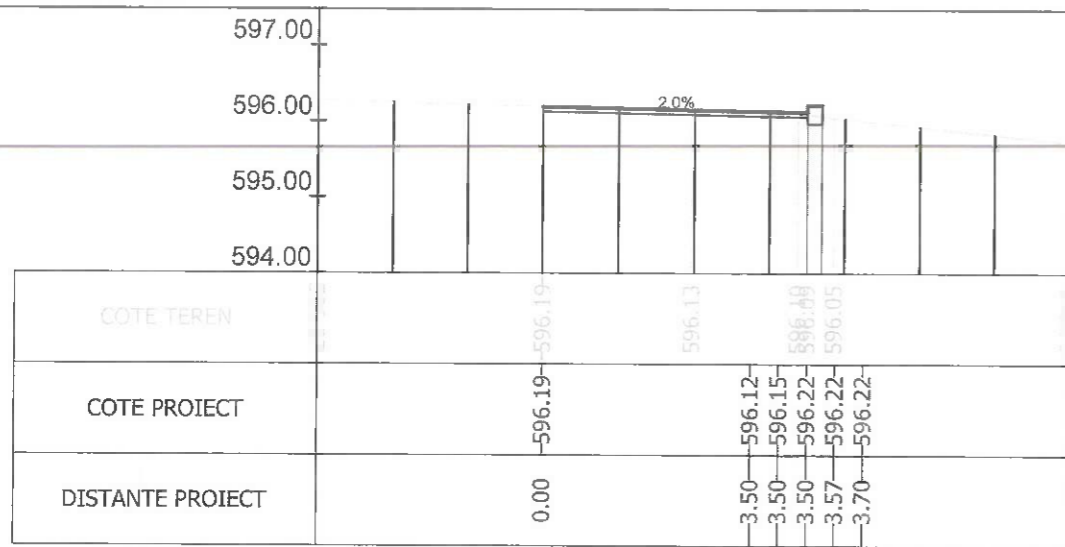

Sectiunea 444 - Km 6+511.550
Ax-Traseul 2

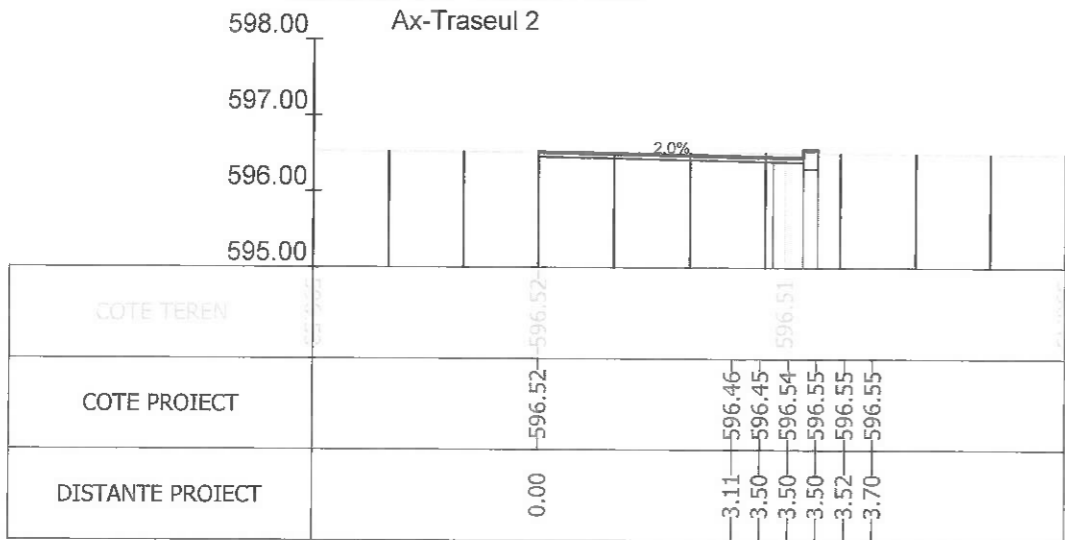

Sectiunea 446 - Km 6+550
Ax-Traseul 2

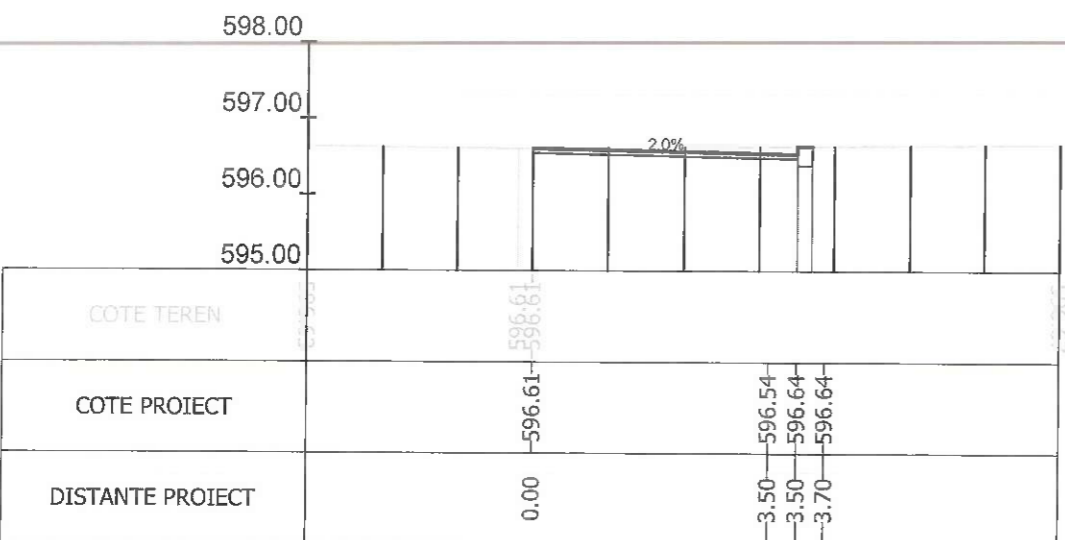

Sectiunea 448 - Km 6+600
Ax-Traseul 2

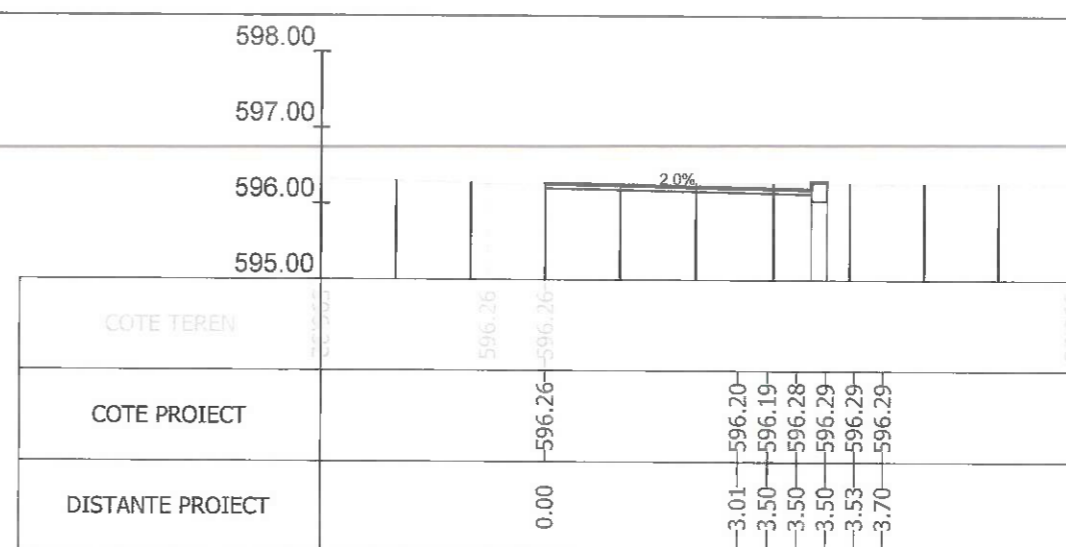

Sectiunea 445 - Km 6+525
Ax-Traseul 2

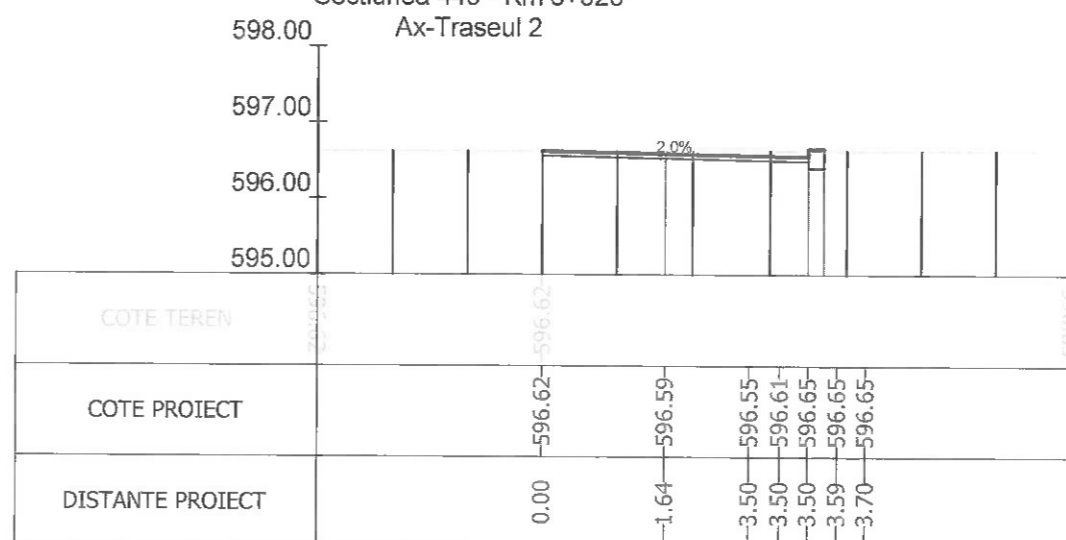

Sectiunea 447 - Km 6+575
Ax-Traseul 2

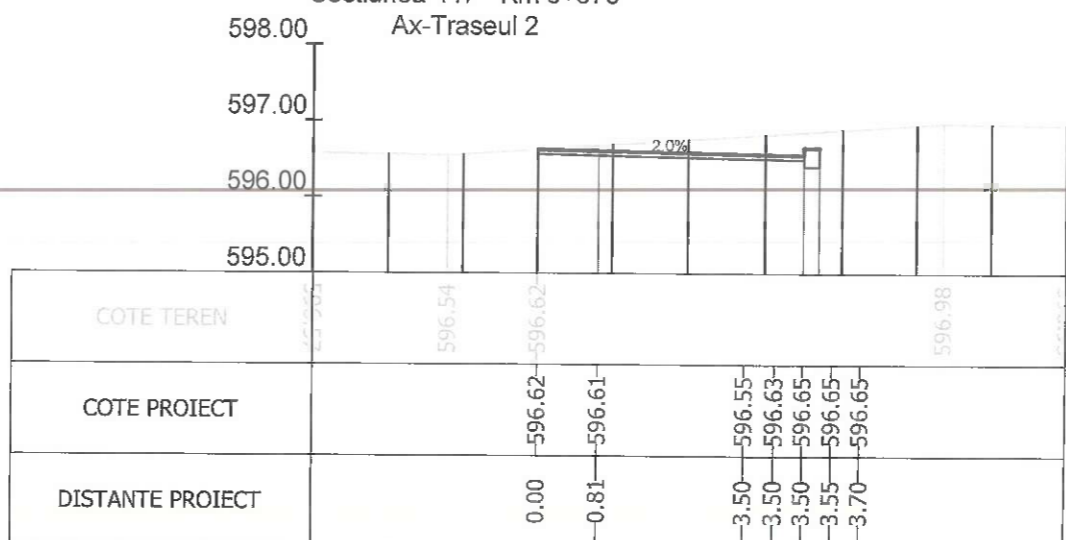

Sectiunea 449 - Km 6+625
Ax-Traseul 2



Index	A		Rev. 5
			Beneficiar:
Sef Proiect: Ing. A. Buta Proiectat: Ing. A. Buta Desenat: Ing. S. Patro Verificat:			MUNICIPIUL BRASOV Bulevardul Eroilor 8, Brasov 500007
Scara: 1/100 Data: 07/2023			Nr. proiect: 73 / 2020 Faza: P.T.
Titlu planşa: PROFILE TRANSVERSALE CURENTE			Nr. planşa: PT-131

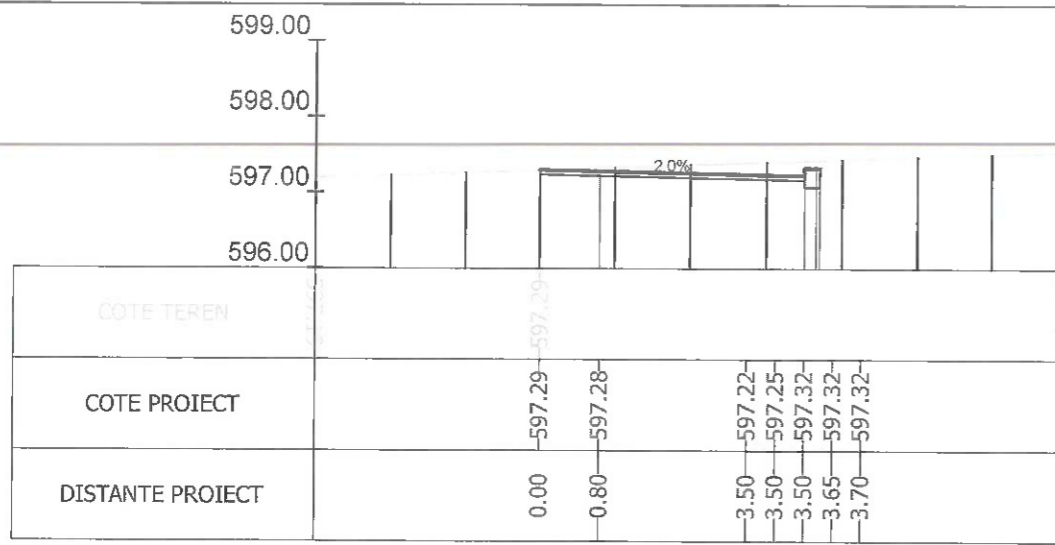

Sectiunea 450 - Km 6+650
Ax-Traseul 2

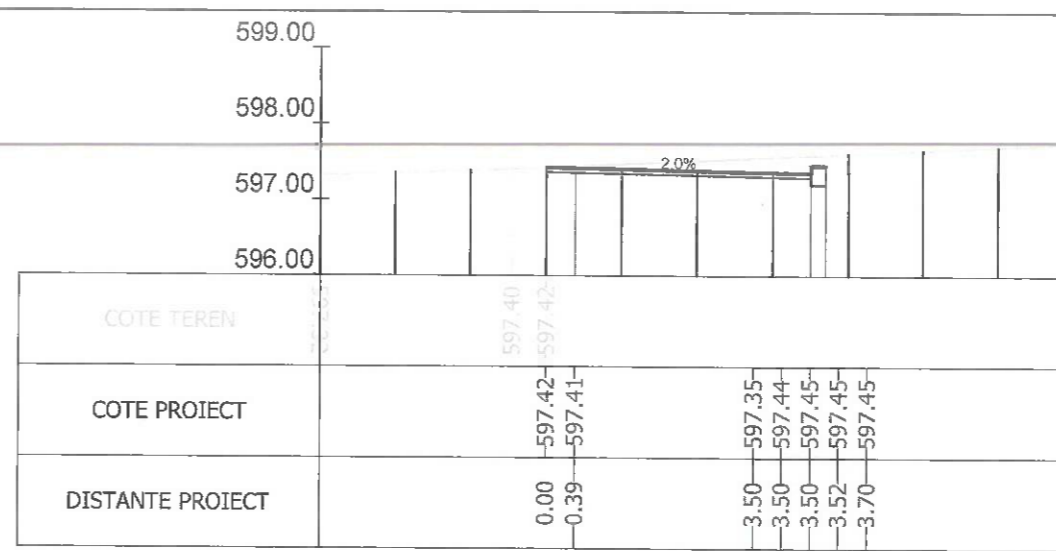

Sectiunea 451 - Km 6+675
Ax-Traseul 2

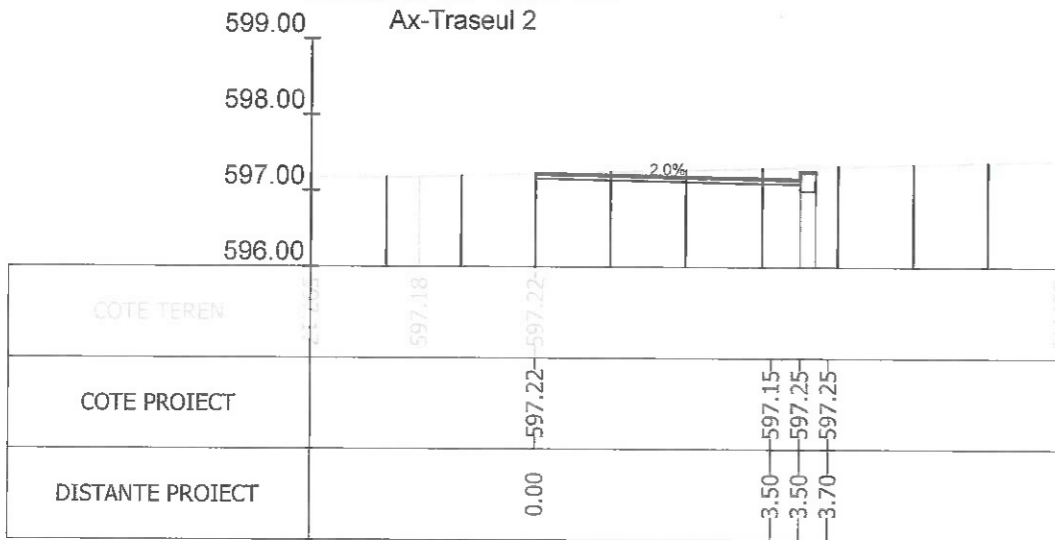

Sectiunea 452 - Km 6+700
Ax-Traseul 2

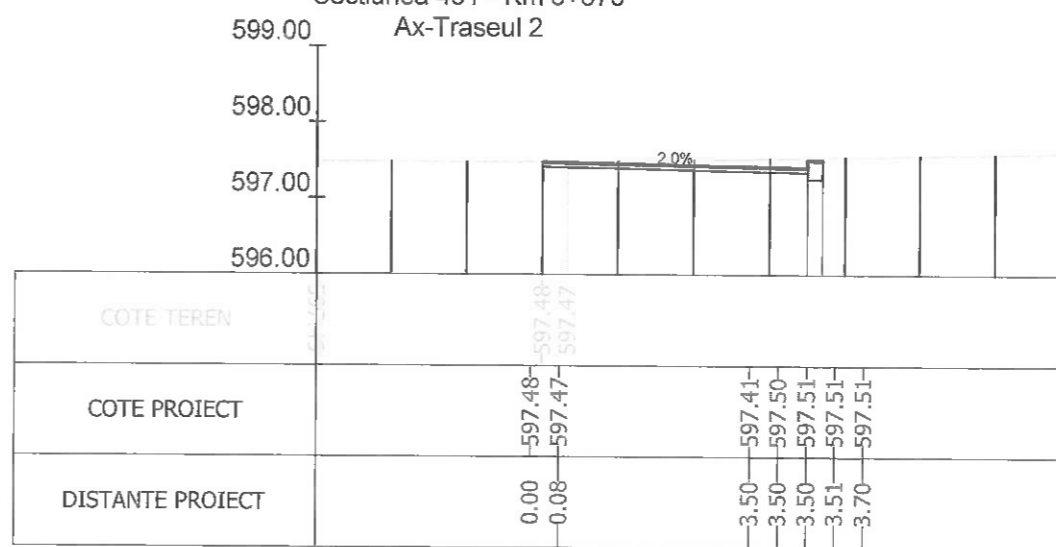

Sectiunea 453 - Km 6+725
Ax-Traseul 2

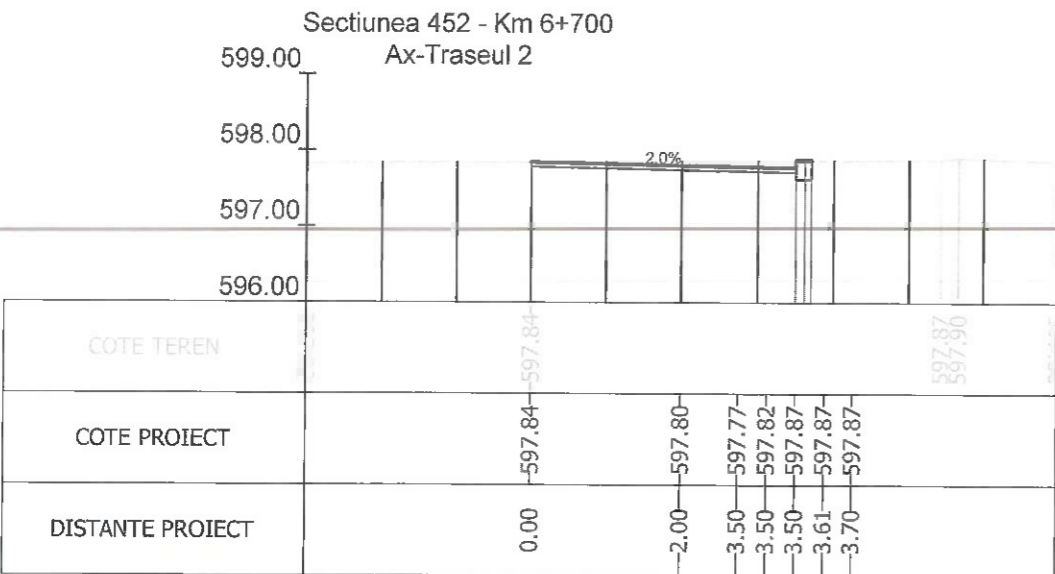

Sectiunea 454 - Km 6+750
Ax-Traseul 2

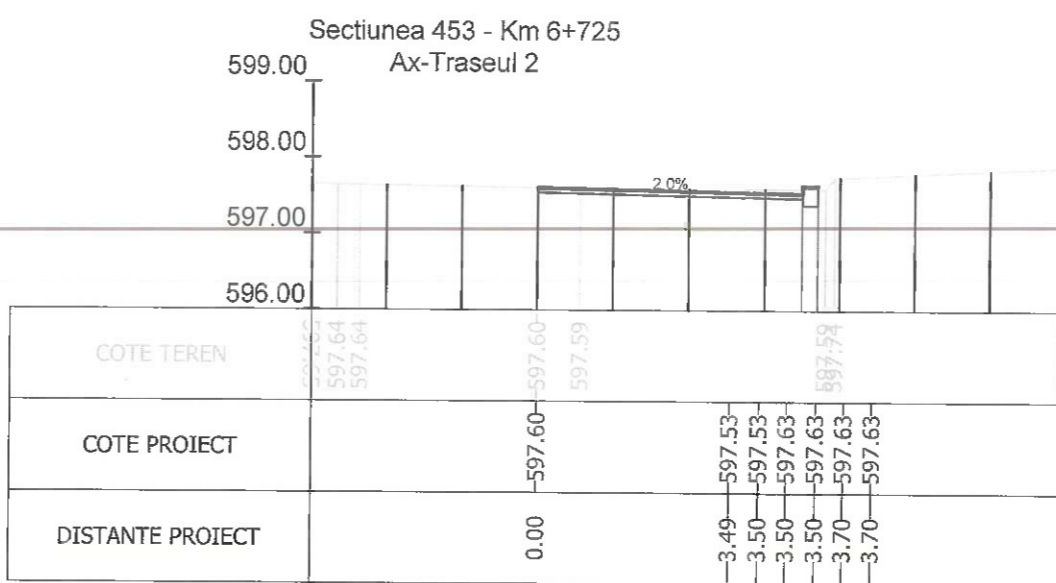

Sectiunea 455 - Km 6+760.759
Ax-Traseul 2



Index	A		Rev. 5
			Beneficiar: MUNICIPIUL BRASOV Bulevardul Eroilor 8, Brasov 500007
Sef Proiect	Ing. A. Buta	Scara 1/100	Nr. proiect 73 / 2020
Proiectat	Ing. A. Buta		Faza P.T.
Desenat	Ing. S. Patroi	Data 07/2023	Titlu proiect: AMENAJARE BENZI DEDICATE TRANSPORTULUI PUBLIC IN MUNICIPIUL BRASOV SI TROTUARE ADIACENTE
Verificat			Titlu planşa: PROFILE TRANSVERSALE CURENTE
			Nr. planşa PT-132

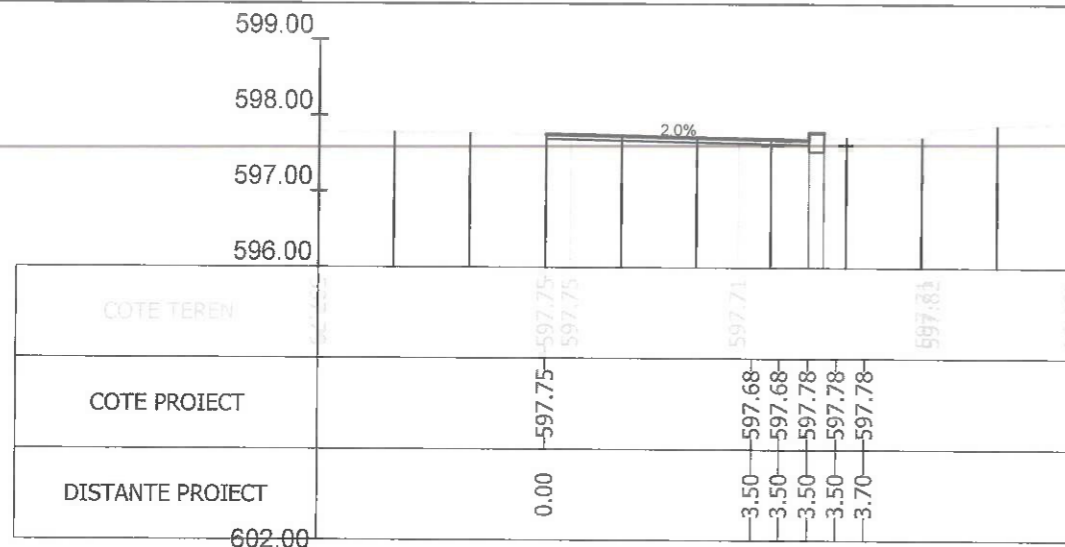

Sectiunea 456 - Km 6+765.747
Ax-Traseul 2

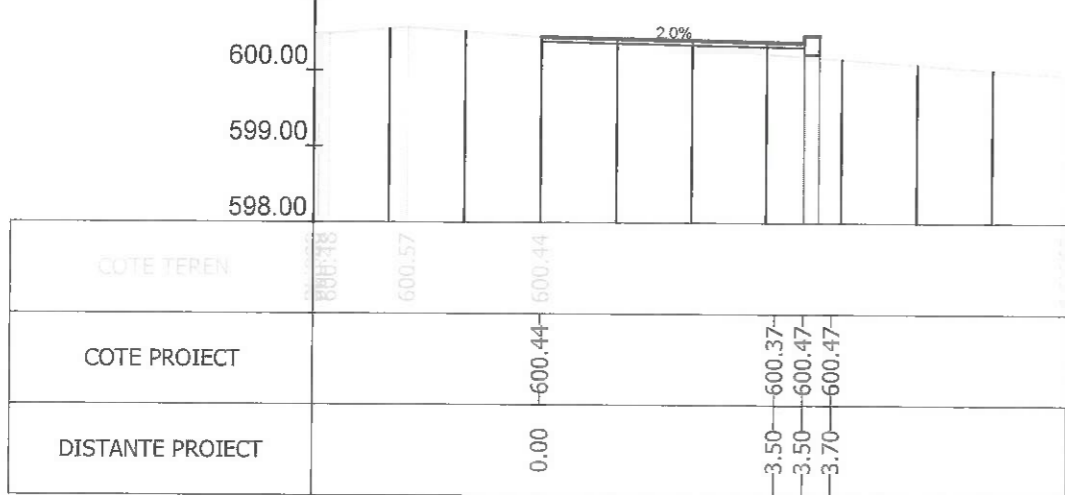

Sectiunea 458 - Km 6+800
Ax-Traseul 2

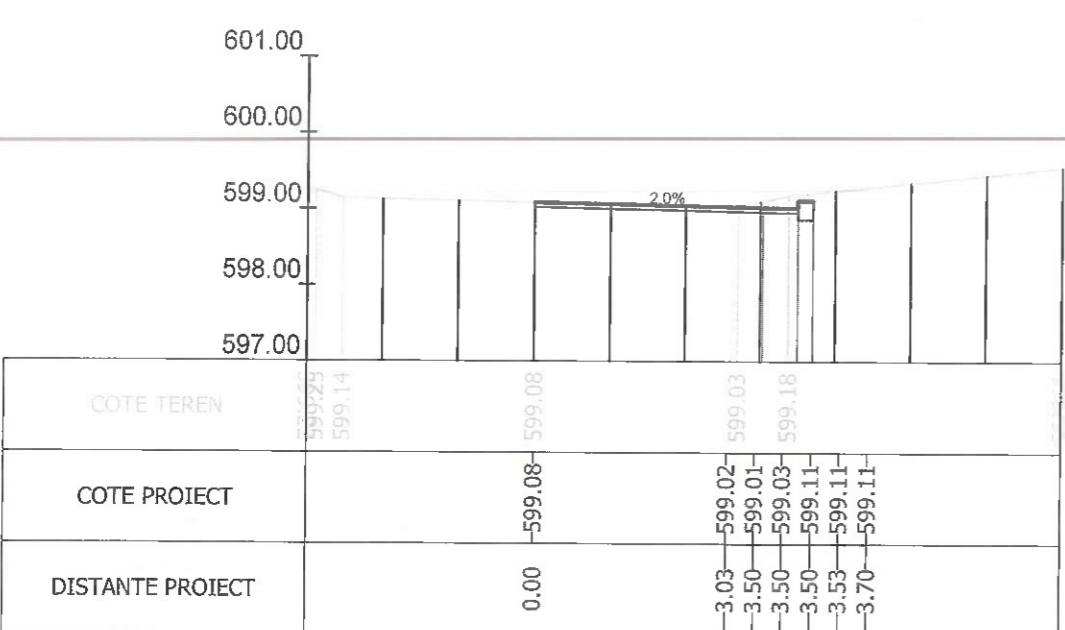

Sectiunea 460 - Km 6+825
Ax-Traseul 2

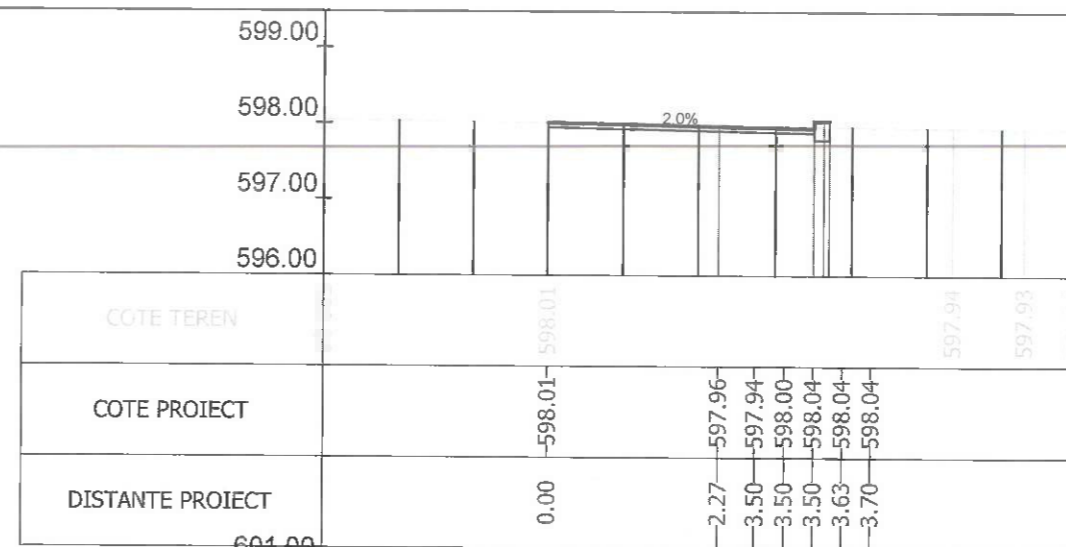

Sectiunea 457 - Km 6+775
Ax-Traseul 2

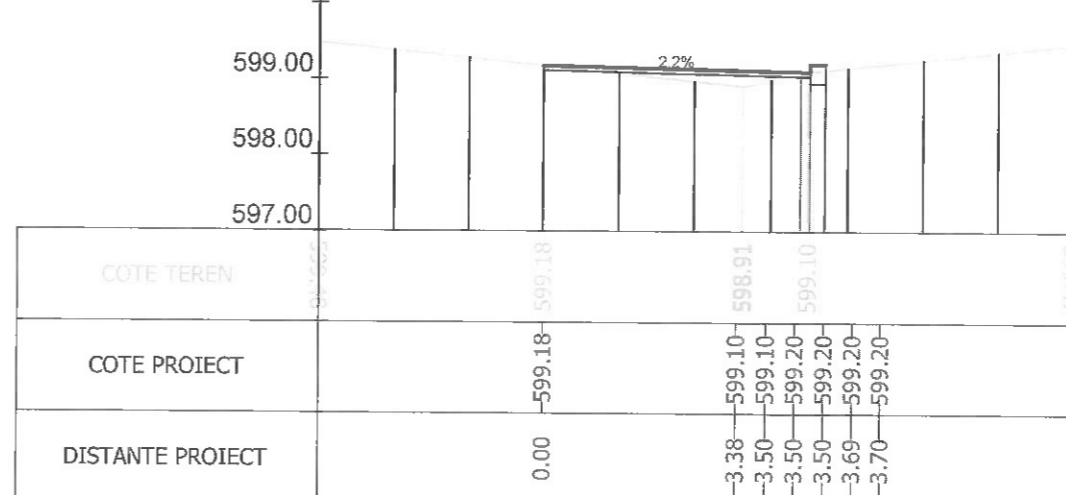

Sectiunea 459 - Km 6+820.154
Ax-Traseul 2

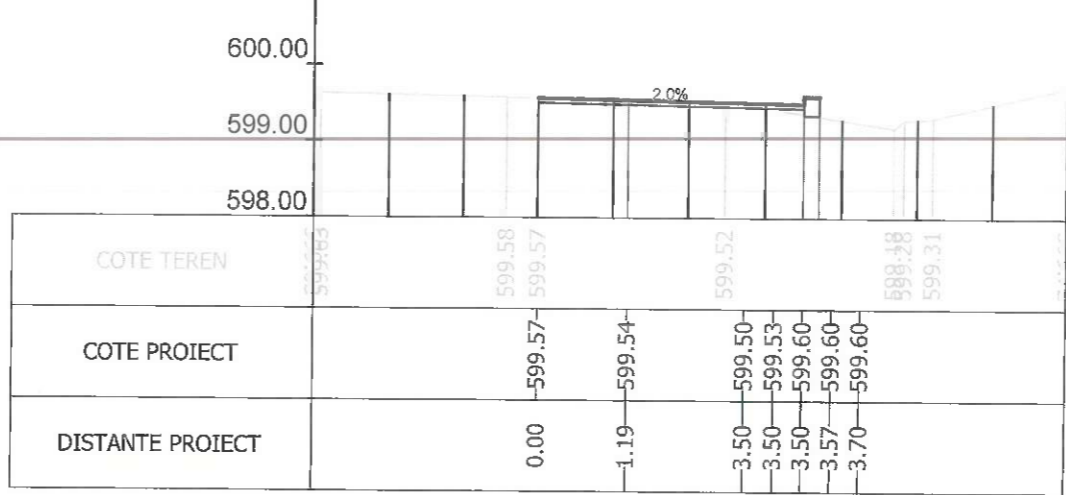

Sectiunea 461 - Km 6+850
Ax-Traseul 2



Index	Data	Observatii	Rev. 5
A			
		Beneficiar:	MUNICIPIUL BRASOV Bulevardul Eroilor 8, Brasov 500007
Sef Proiect: Ing. A. Buta Proiectat: Ing. A. Buta Desenat: Ing. S. Patroi Verificat:		Titlu proiect:	AMENAJARE BENZI DEDICATE TRANSPORTULUI PUBLIC IN MUNICIPIUL BRASOV SI TROTUARE ADIACENTE
Scara: 1/100		Titlu plansa:	PROFILE TRANSVERSALE CURENTE
Data: 07/2023		Nr. proiect:	73 / 2020
		Nr. plansa:	PT-133

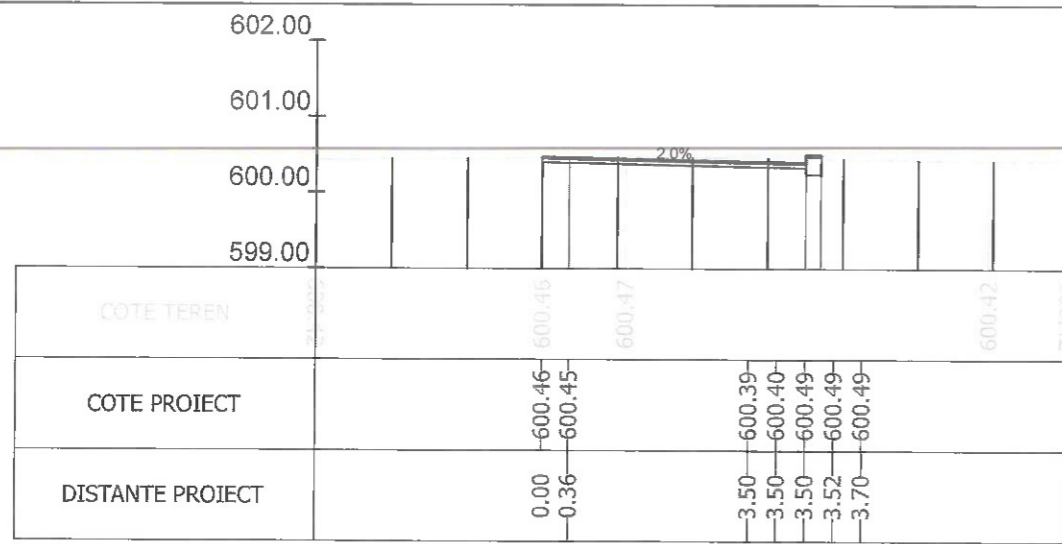

Sectiunea 462 - Km 6+875
Ax-Traseul 2

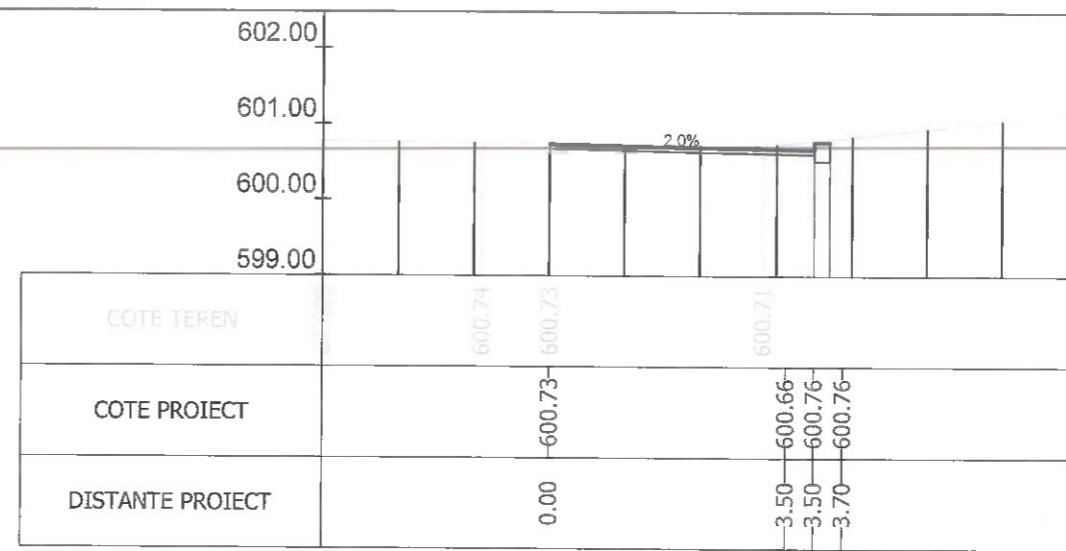

Sectiunea 463 - Km 6+900
Ax-Traseul 2

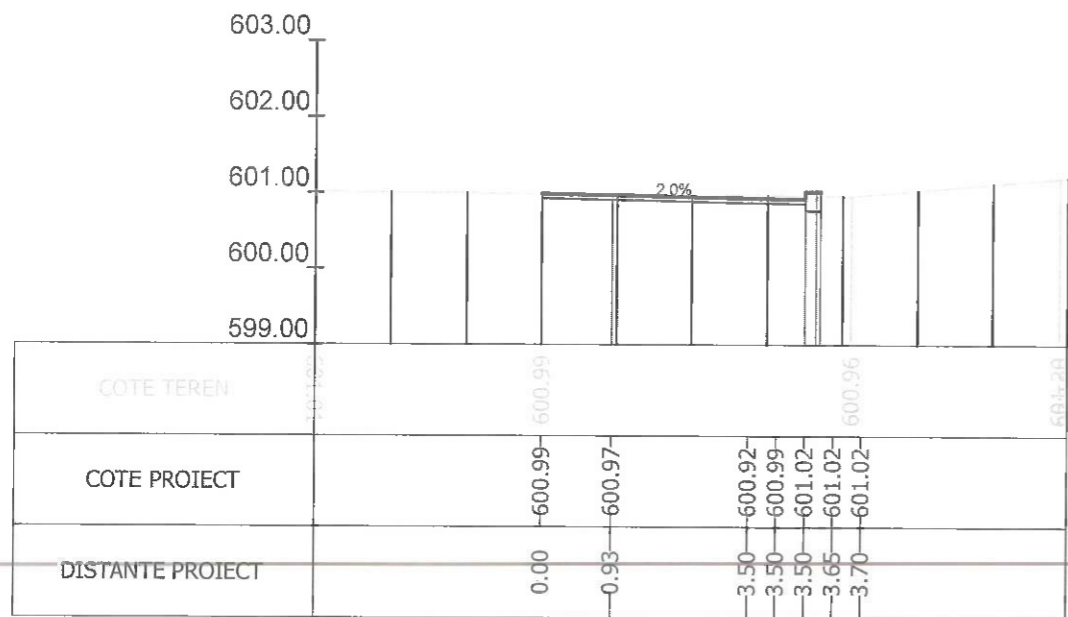

Sectiunea 464 - Km 6+925
Ax-Traseul 2

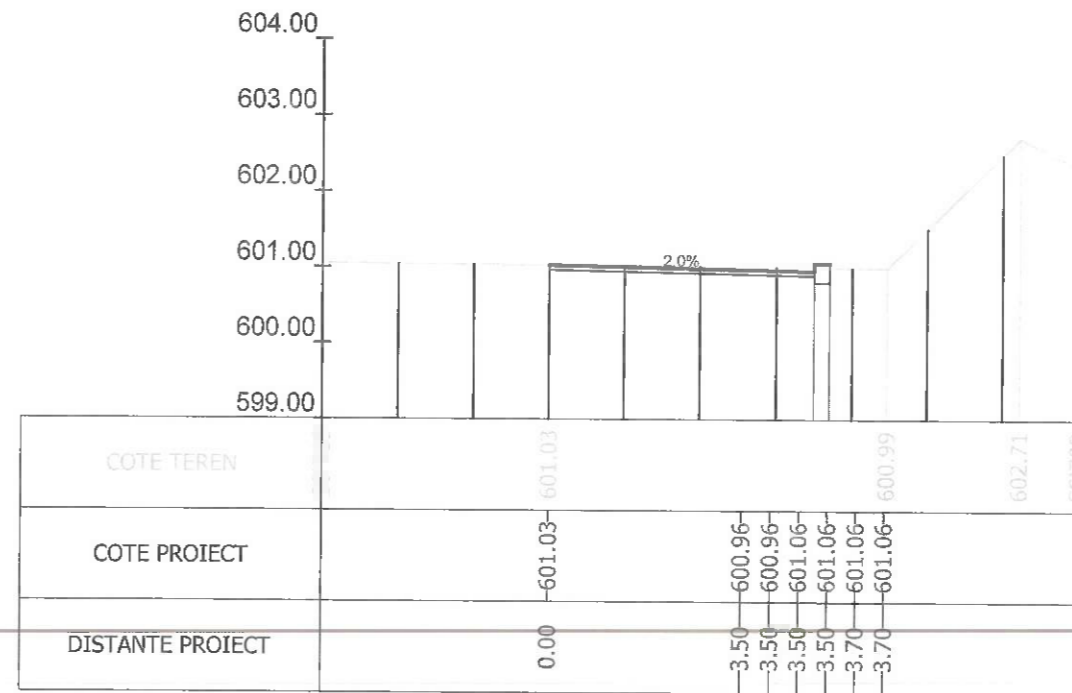

Sectiunea 465 - Km 6+928.790
Ax-Traseul 2



Index	Data	Observatii	Rev. 5
A			
		Beneficiar:	MUNICIPIUL BRASOV Bulevardul Eroilor 8, Brasov 500007
Sef Proiect: Ing. A. Buta Proiectat: Ing. A. Buta Desenat: Ing. S. Patroi Verificat:		Titlu proiect:	AMENAJARE BENZI DEDICATE TRANSPORTULUI PUBLIC IN MUNICIPIUL BRASOV SI TROTUARE ADIACENTE
Scara: 1/100		Titlu plansa:	PROFILI TRANSVERSALE CURENTE
Data: 07/2023		Nr. proiect:	73 / 2020
		Faza:	P.T.
		Nr. plansa:	PT-134

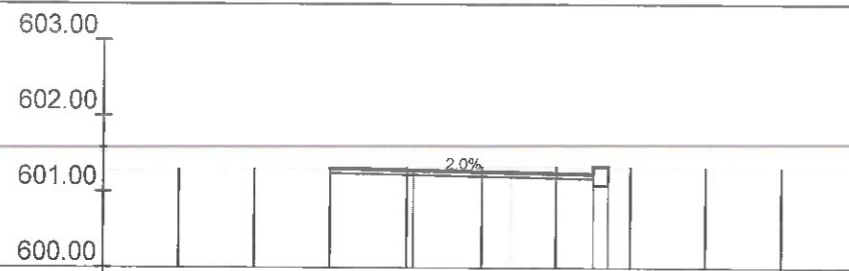

COTE TEREN		601.30	601.33	
COTE PROIECT		601.30	601.28	601.23 601.30 601.33 601.33 601.33
DISTANTE PROIECT		0.00	1.09	3.50 3.50 3.50 3.56 3.70

Sectiunea 466 - Km 6+950
Ax-Traseul 2

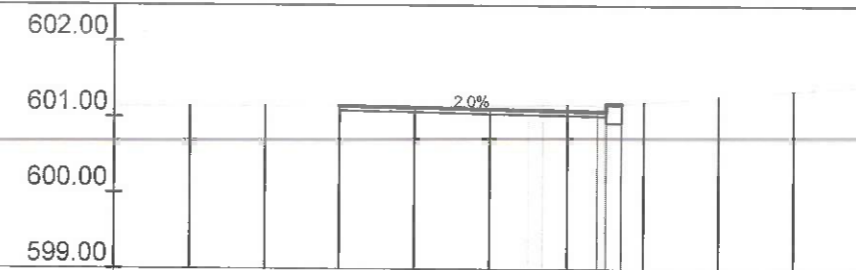

COTE TEREN		601.15	601.16	601.16
COTE PROIECT		601.15	601.08	601.07 601.17 601.17 601.17
DISTANTE PROIECT		0.00	3.39	3.50 3.50 3.50 3.69 3.70

Sectiunea 467 - Km 6+969.079
Ax-Traseul 2

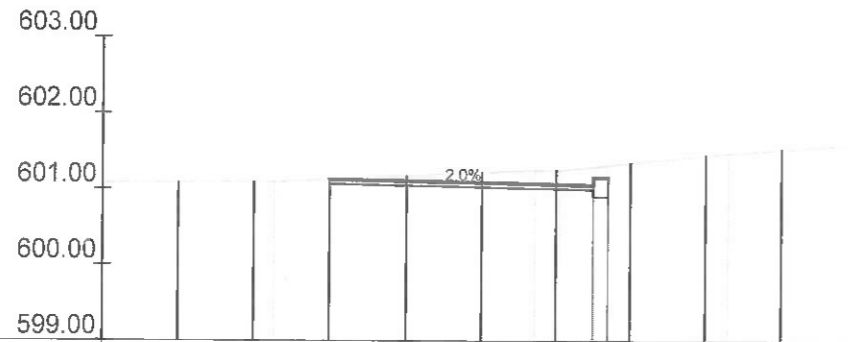

COTE TEREN		601.09	601.12	601.25	601.48
COTE PROIECT		601.12	601.05	601.15	601.15
DISTANTE PROIECT		0.00	3.50	3.50	3.70

Sectiunea 468 - Km 6+971.866
Ax-Traseul 2



Index	Data	Observatii	Rev. 5
A			
		Beneficiar:	MUNICIPIUL BRASOV Bulevardul Eroilor 8, Brasov 500007
Sef Proiect Proiectat Desenat Verificat		Ing. A. Buta Ing. A. Buta Ing. S. Patroi	Nr. proiect 73 / 2020 Faza P.T. Nr. plansa PT-134
Scara 1/100 Data 07/2023		Titlu proiect: AMENAJARE BENZI DEDICATE TRANSPORTULUI PUBLIC IN MUNICIPIUL BRASOV SI TROTUARE ADJACENTE Titlu plansa: PROFILE TRANSVERSALE CURENTE	

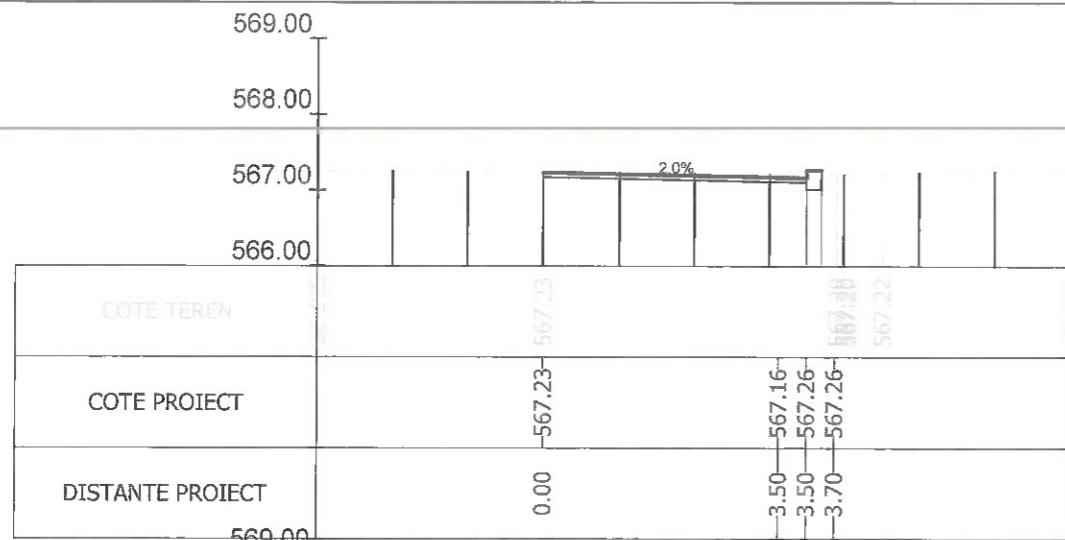

Sectiunea 1 - Km -0+000
Ax-Traseul 3_1

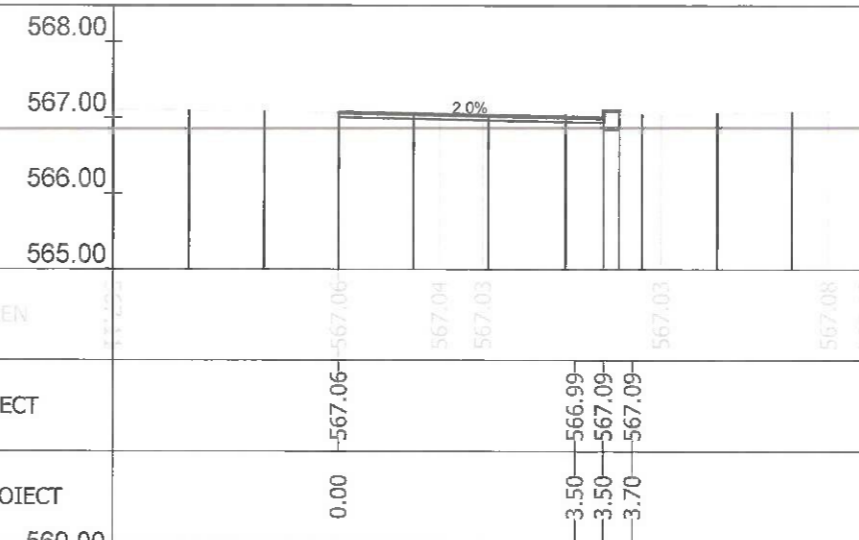
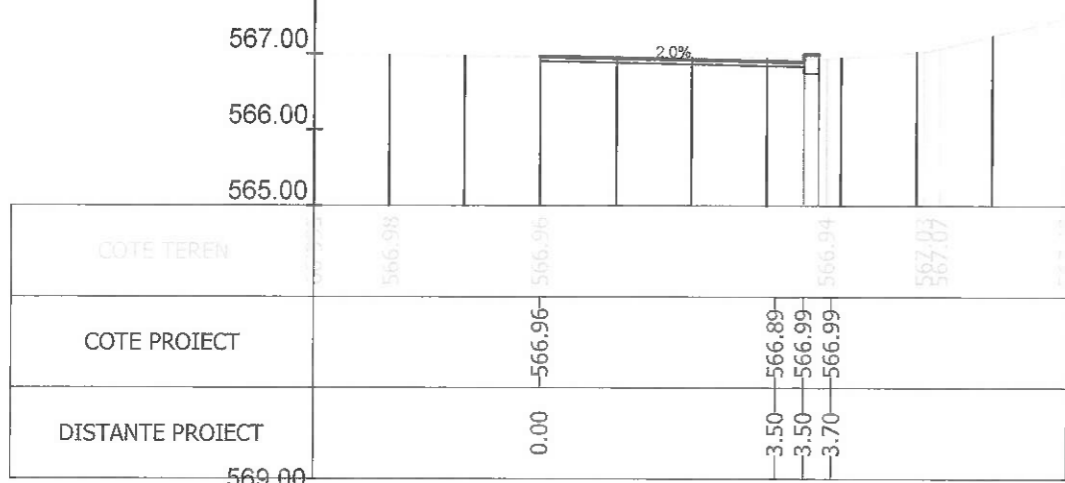

Sectiunea 2 - Km 0+011.721
Ax-Traseul 3_1

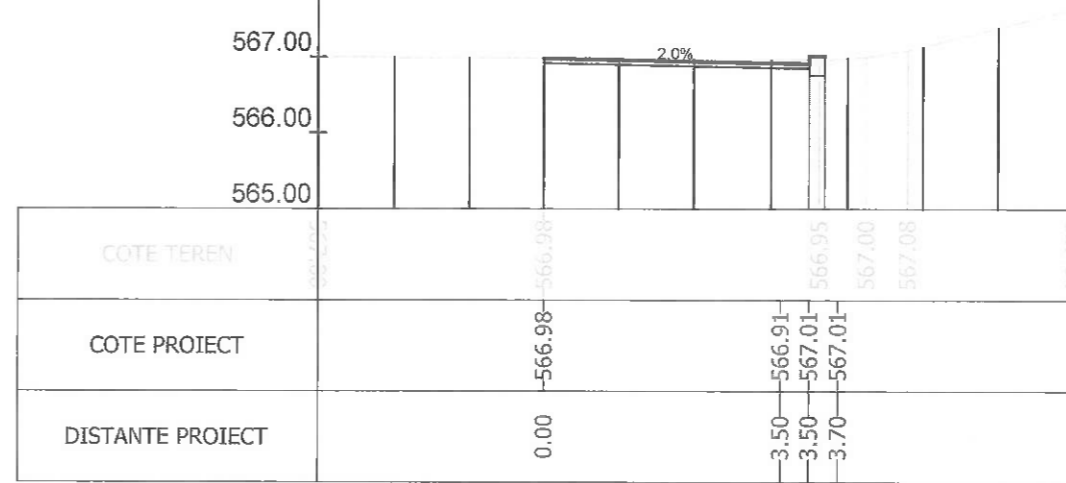

Sectiunea 4 - Km 0+025
Ax-Traseul 3_1

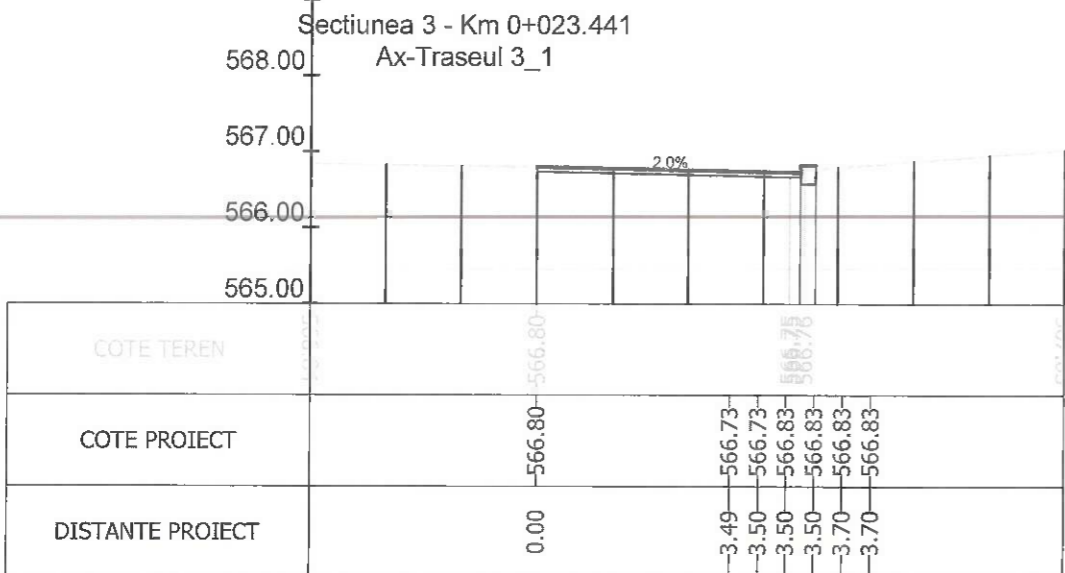

Sectiunea 5 - Km 0+038.771
Ax-Traseul 3_1

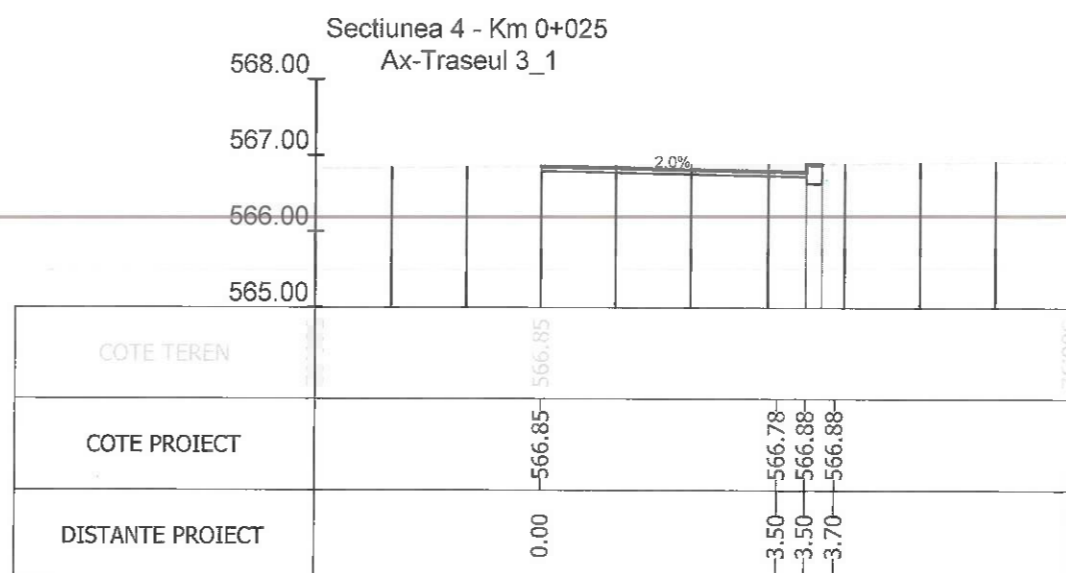

Sectiunea 6 - Km 0+050
Ax-Traseul 3_1



Index	A	Rev. 5
		Beneficiar: MUNICIPIUL BRASOV Bulevardul Eroilor 8, Brasov 500007
Sef Proiect: Ing. A. Buta Proiectat: Ing. A. Buta Desenat: Ing. S. Patroi Verificat:		Nr. proiect: 73 / 2020 Faza: P.T. Nr. planșa: PT-136
Scara: 1/100 Data: 07/2023		Titlu proiect: AMENAJARE BENZI DEDICATE TRANSPORTULUI PUBLIC IN MUNICIPIUL BRASOV SI TROTUARE ADIACENTE Titlu planșa: PROFILE TRANSVERSALE CURENTE

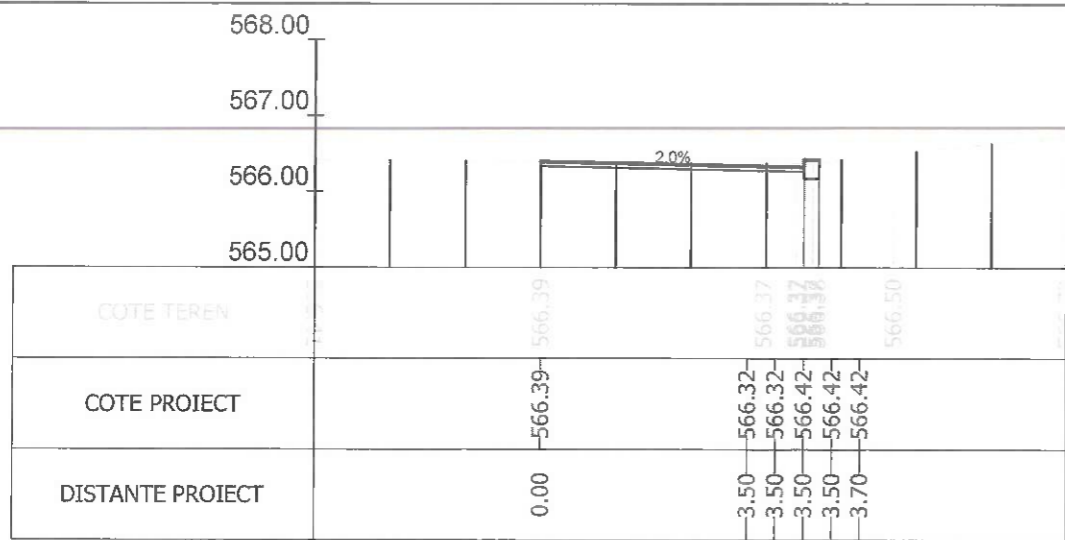

Sectiunea 7 - Km 0+072.264

Ax-Traseul 3_1

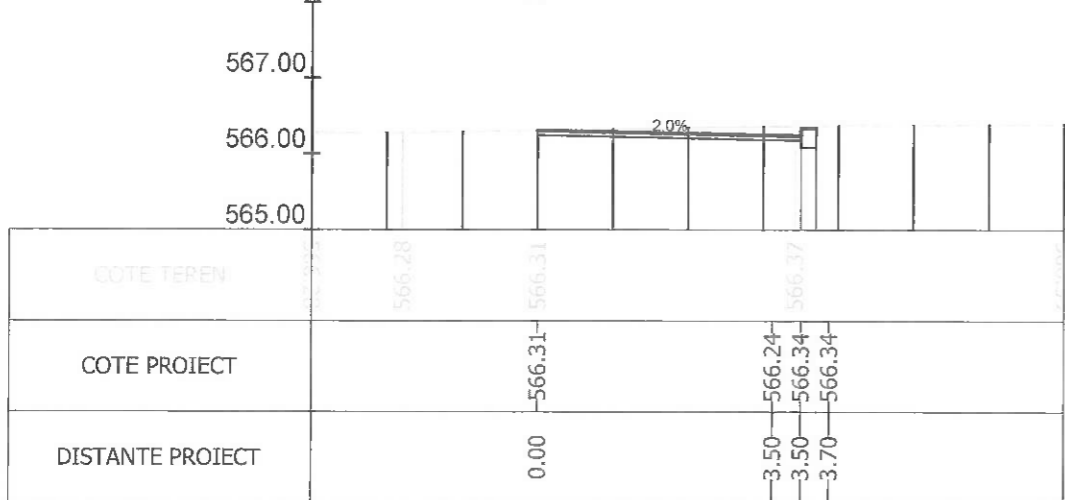

Sectiunea 9 - Km 0+100

Ax-Traseul 3_1

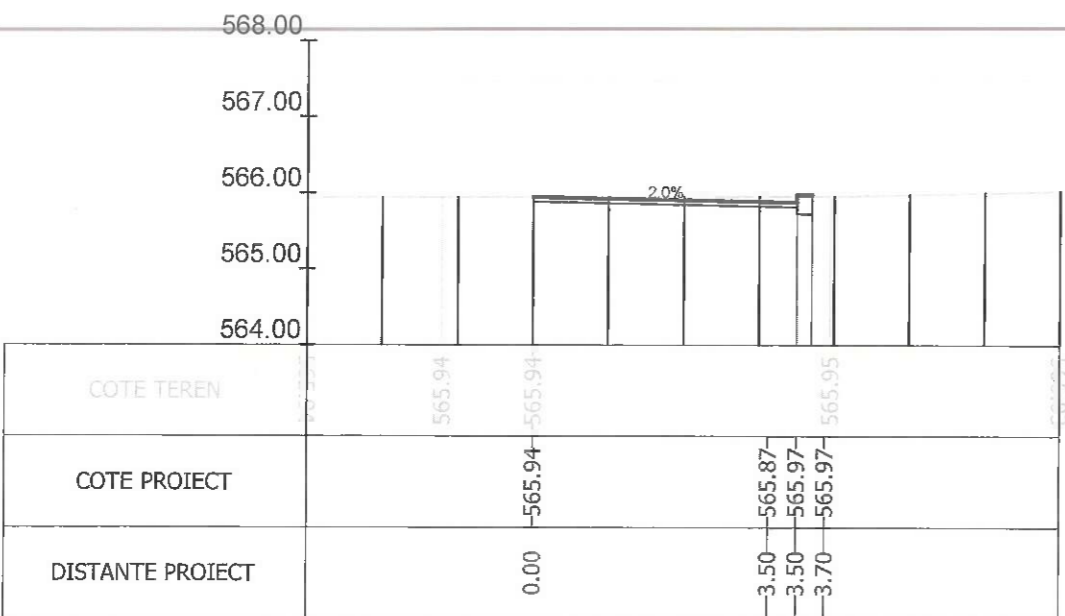

Sectiunea 11 - Km 0+125

Ax-Traseul 3_1

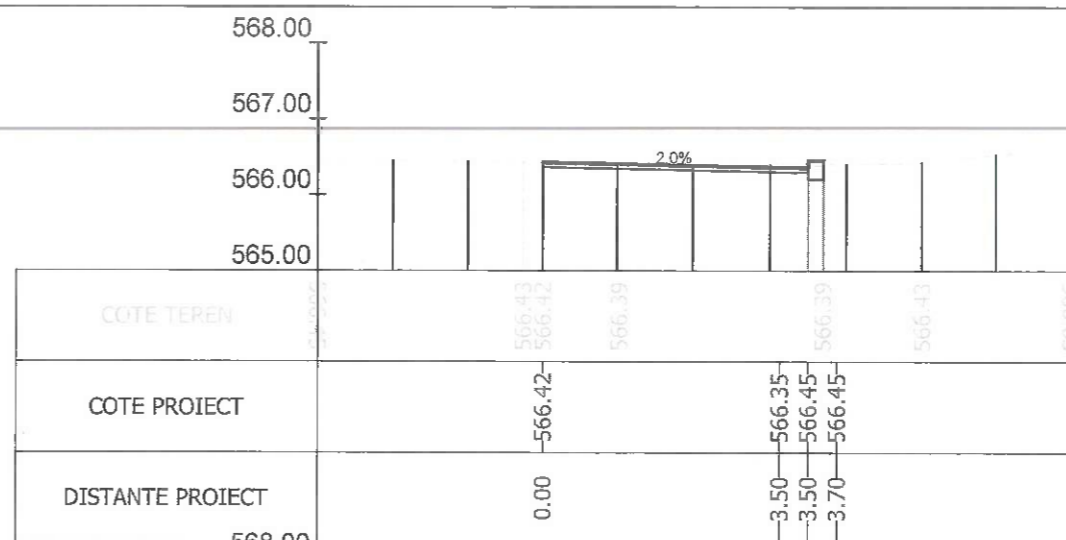

Sectiunea 8 - Km 0+075

Ax-Traseul 3_1

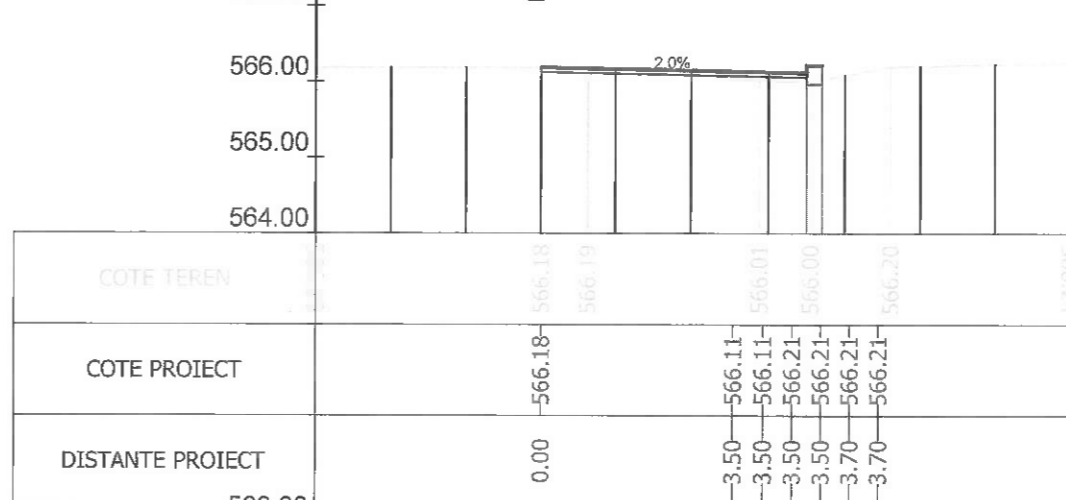

Sectiunea 10 - Km 0+110.489

Ax-Traseul 3_1

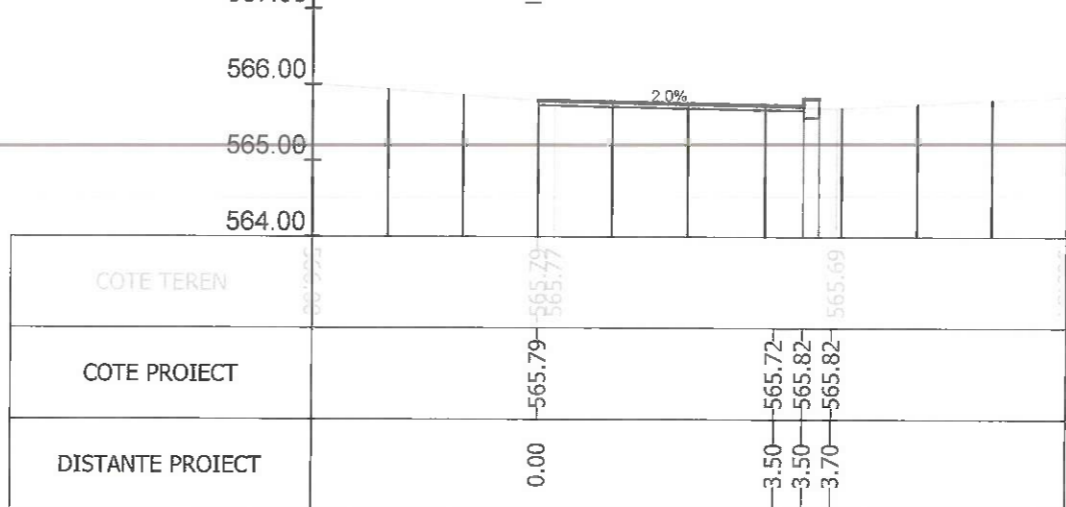

Sectiunea 12 - Km 0+150

Index	A	Data	07/2023	Rev. 5
		Beneficiar: MUNICIPIUL BRASOV Bulevardul Eroilor 8, Brasov 500007		Nr. proiect 73 / 2020
Sef Proiect Ing. A. Buta Proiectat Ing. A. Buta Desenat Ing. S. Patroi Verificat		Scara 1/100 Data 07/2023		Faza P.T. Nr. plansa PT-137
Titlu proiect: AMENAJARE BENZI DEDICATE TRANSPORTULUI PUBLIC IN MUNICIPIUL BRASOV SI TROTUARE ADIACENTE Titlu plansa: PROFILE TRANSVERSALE CURENTE				



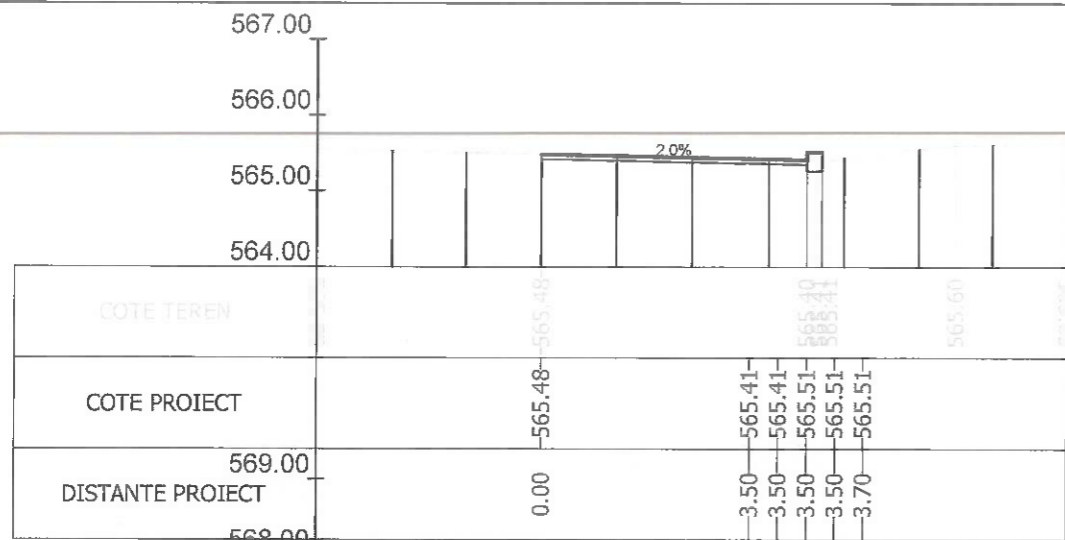

Sectiunea 13 - Km 0+167.654
Ax-Traseul 3_1

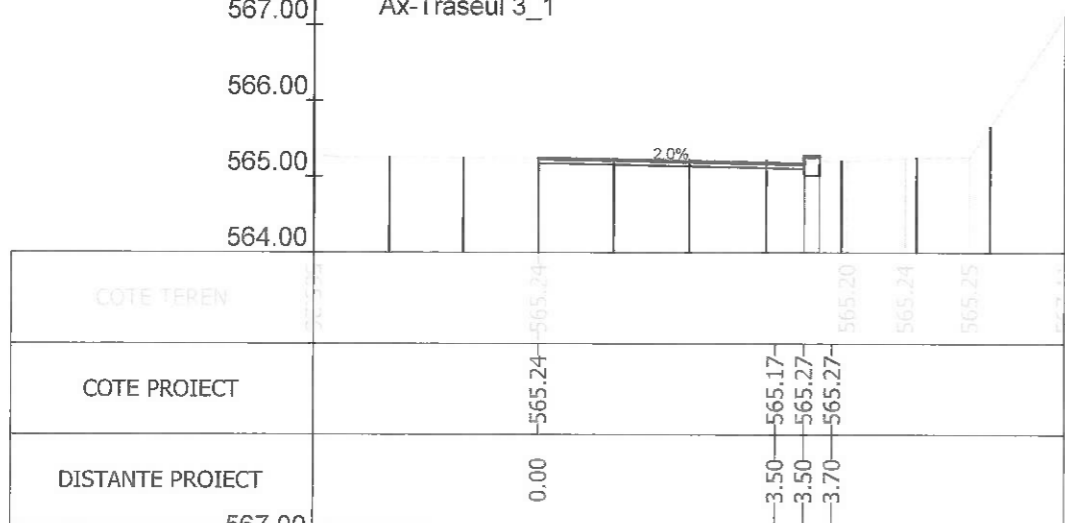

Sectiunea 15 - Km 0+200
Ax-Traseul 3_1

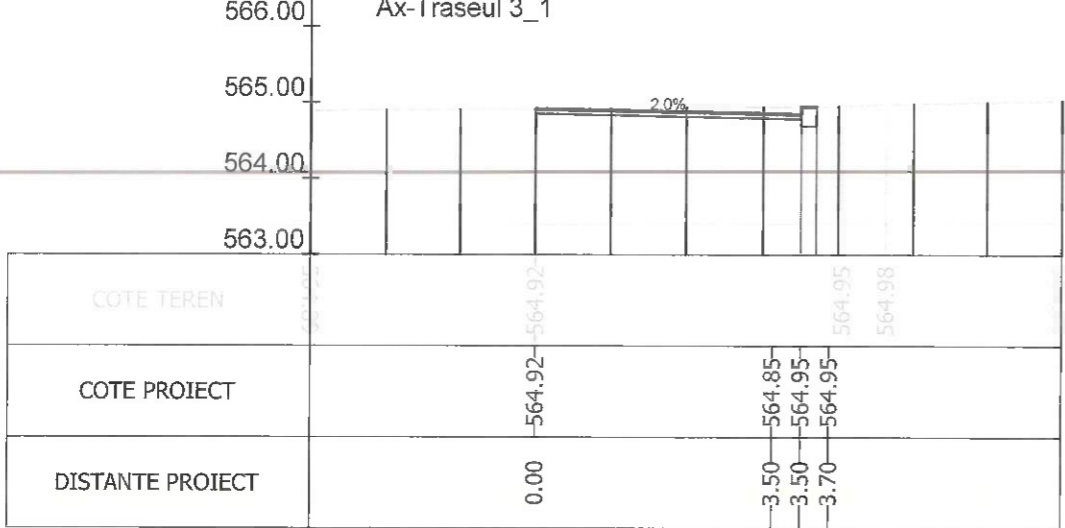

Sectiunea 17 - Km 0+225
Ax-Traseul 3_1

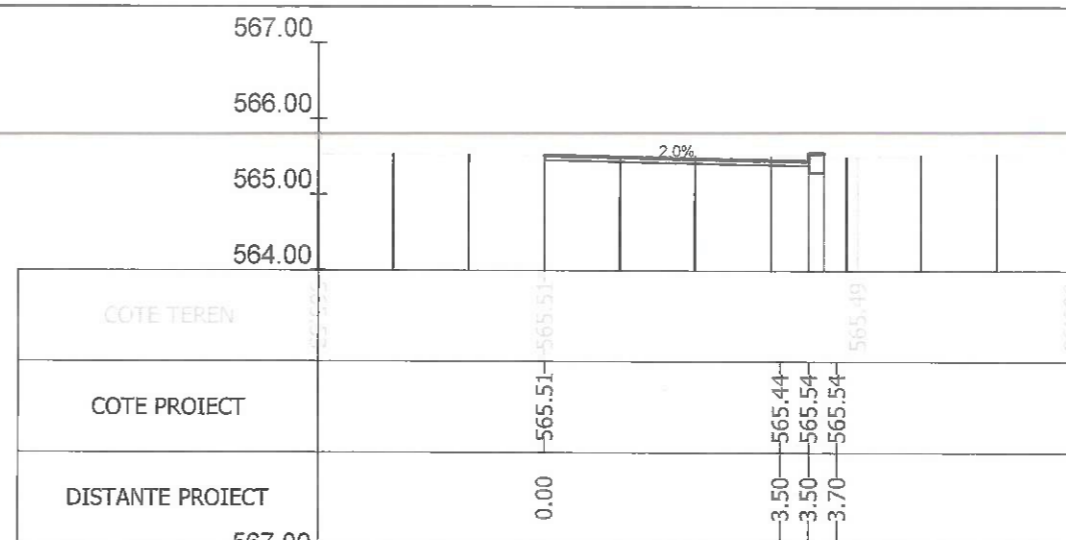

Sectiunea 14 - Km 0+175
Ax-Traseul 3_1

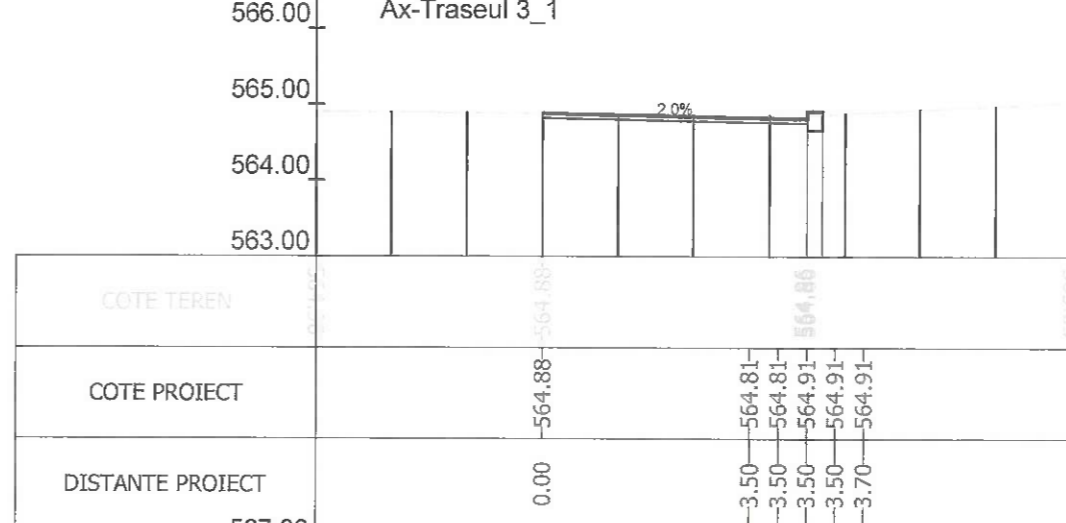

Sectiunea 16 - Km 0+221.372
Ax-Traseul 3_1

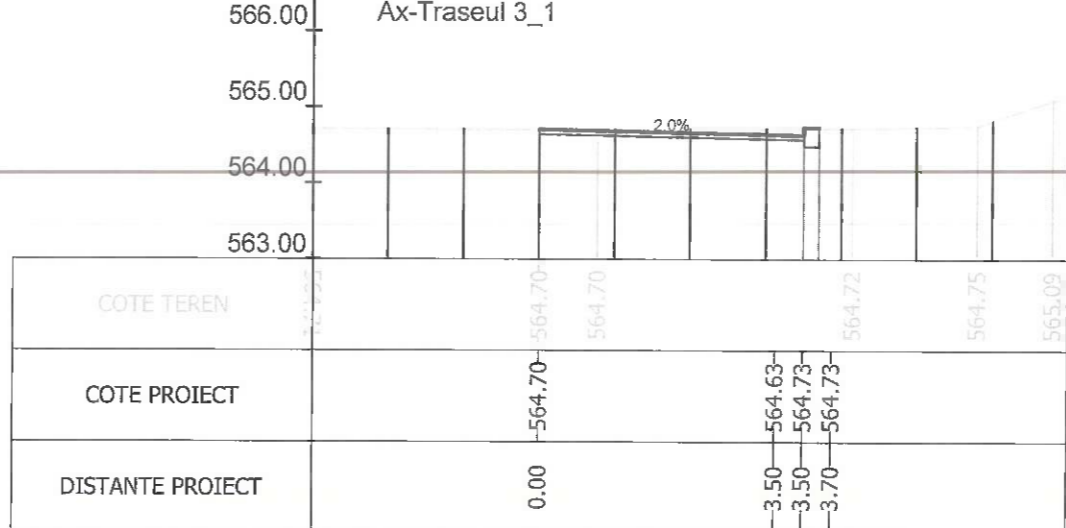

Sectiunea 18 - Km 0+250
Ax-Traseul 3_1

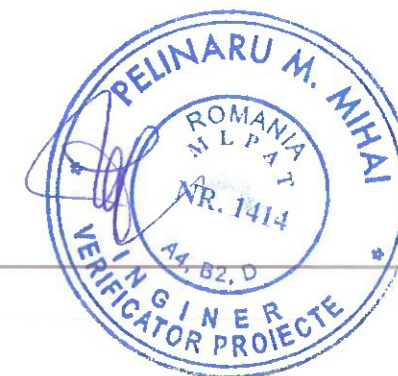

Index	A	Data	07/2023	Rev. 5
		Beneficiar: MUNICIPIUL BRASOV Bulevardul Eroilor 8, Brasov 500007		Nr. proiect 73 / 2020
Sef Proiect: Ing. A. Buta Proiectat: Ing. A. Buta Desenat: Ing. S. Patroi Verificat:		Titlu proiect: AMENAJARE BENZI DEDICATE TRANSPORTULUI PUBLIC IN MUNICIPIUL BRASOV SI TROTUARE ADIACENTE Titlu plansa: PROFILE TRANSVERSALE CURENTE		Faza P.T. Nr. plansa PT-138
		Scara: 1/100 Data: 07/2023		

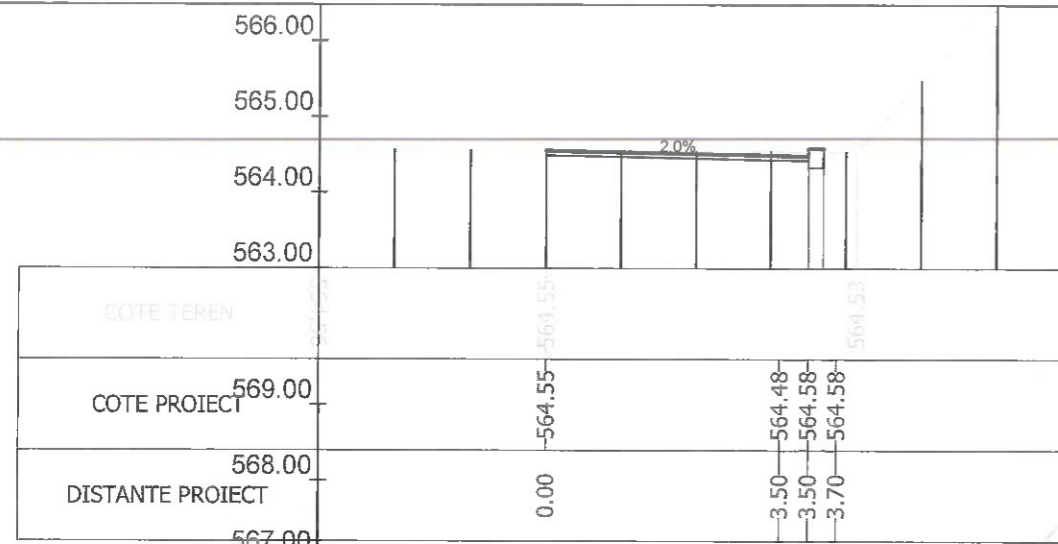

Sectiunea 19 - Km 0+272.197
Ax-Traseul 3_1

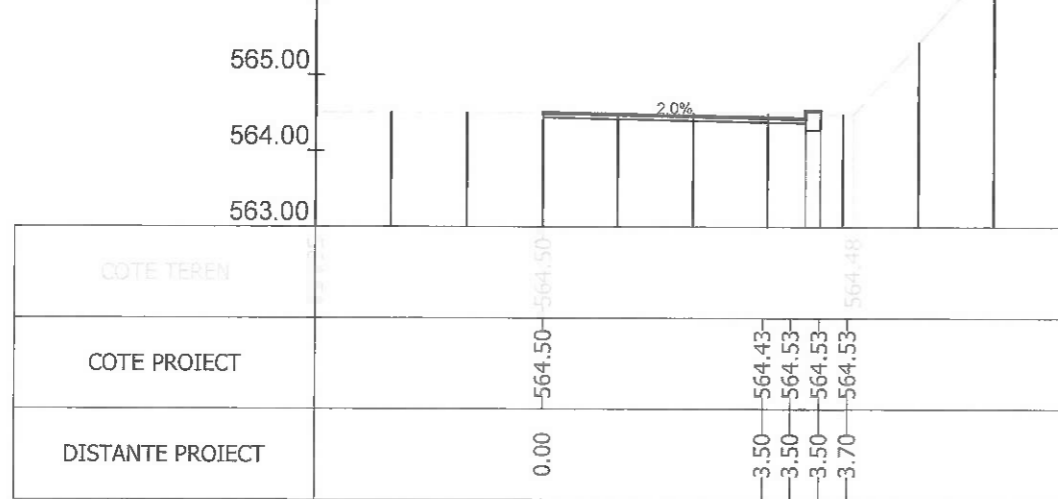

Sectiunea 21 - Km 0+278.258
Ax-Traseul 3_1

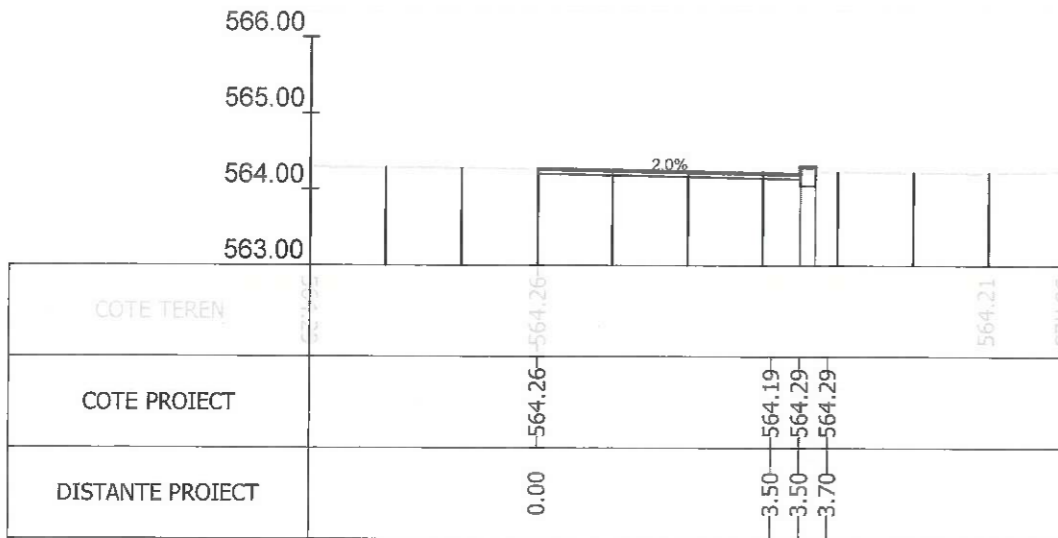

Sectiunea 23 - Km 0+300
Ax-Traseul 3_1

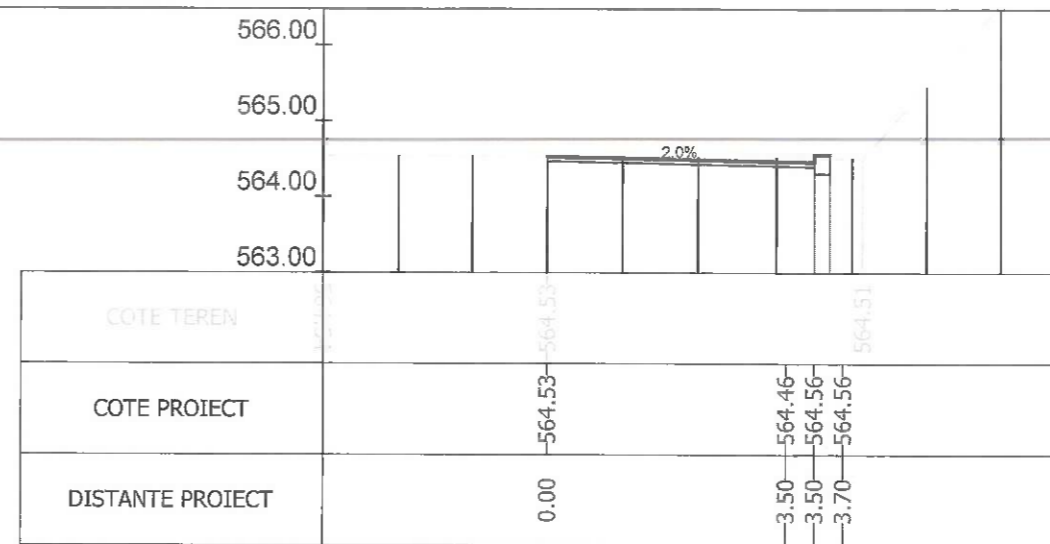

Sectiunea 20 - Km 0+275
Ax-Traseul 3_1

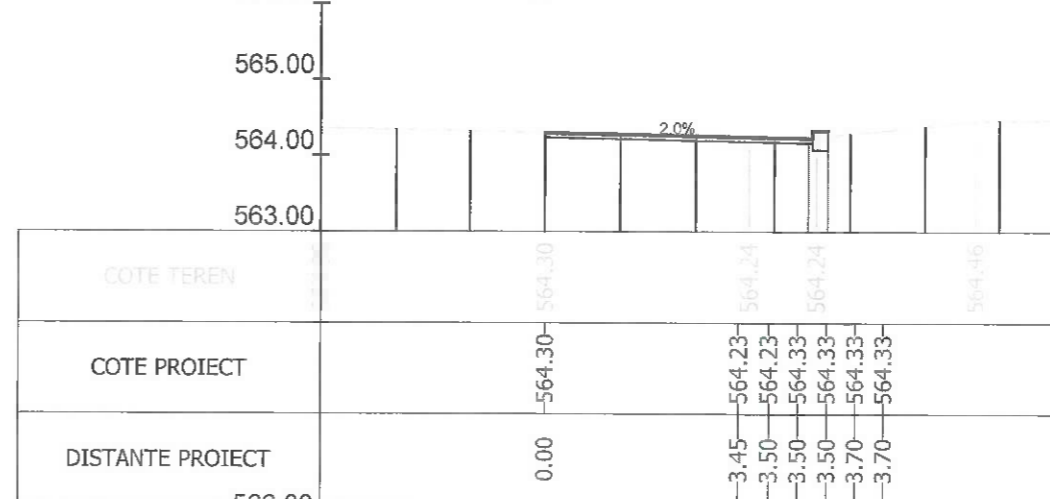

Sectiunea 22 - Km 0+283.608
Ax-Traseul 3_1

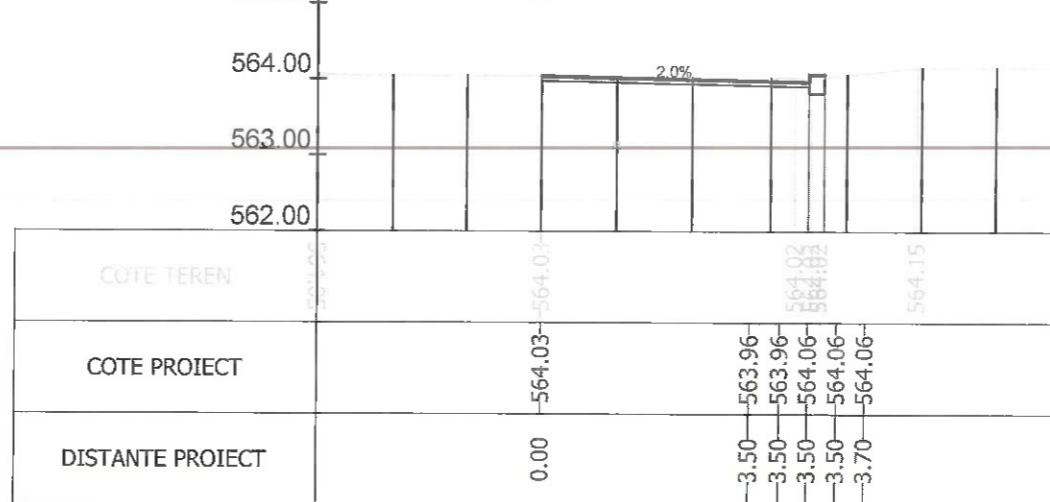

Sectiunea 24 - Km 0+309.342
Ax-Traseul 3_1



Index	A		Rev. 5
			Beneficiar:
Sef Proiect: Ing. A. Buta Proiectat: Ing. A. Buta Desenat: Ing. S. Patro Verificat:			MUNICIPIUL BRASOV Bulevardul Eroilor 8, Brasov 500007
Scara: 1/100 Data: 07/2023			Nr. proiect: 73 / 2020 Faza: P.T.
Titlu proiect: AMENAJARE BENZI DEDICATE TRANSPORTULUI PUBLIC IN MUNICIPIUL BRASOV SI TROTUARE ADIACENTE			Nr. plansa: PT-139
Titlu plansa: PROFILE TRANSVERSALE CURENTE			

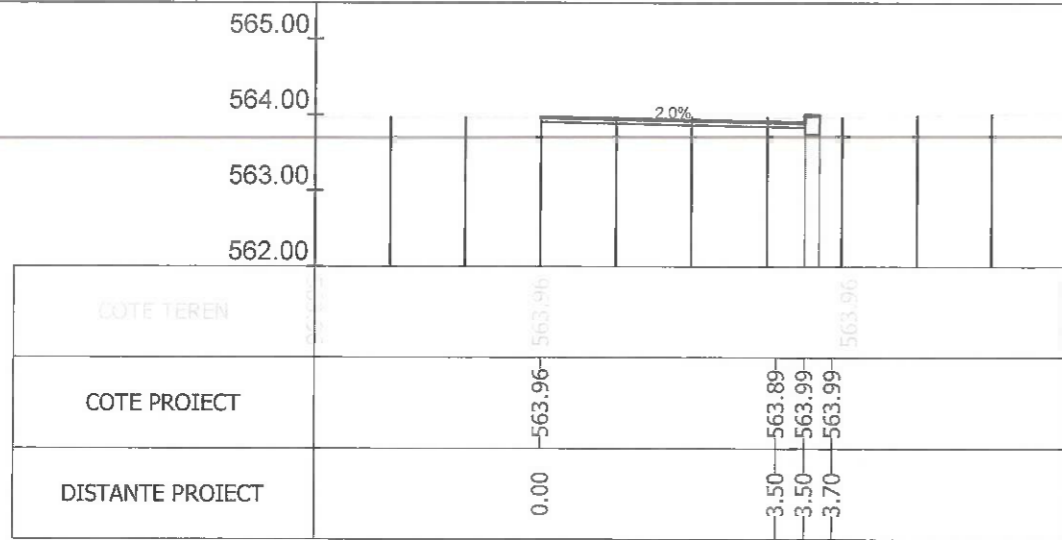

Sectiunea 25 - Km 0+325
Ax-Traseul 3_1

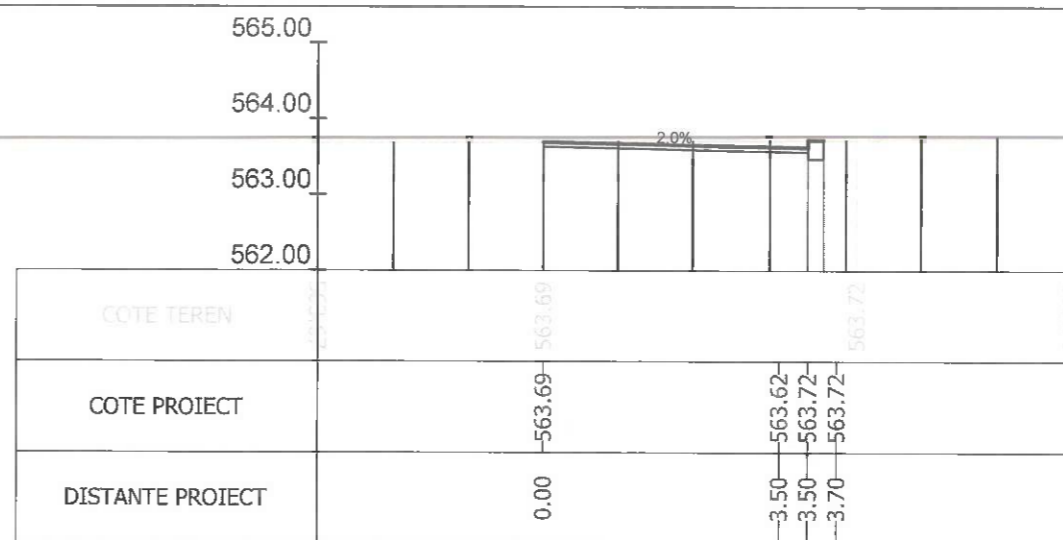
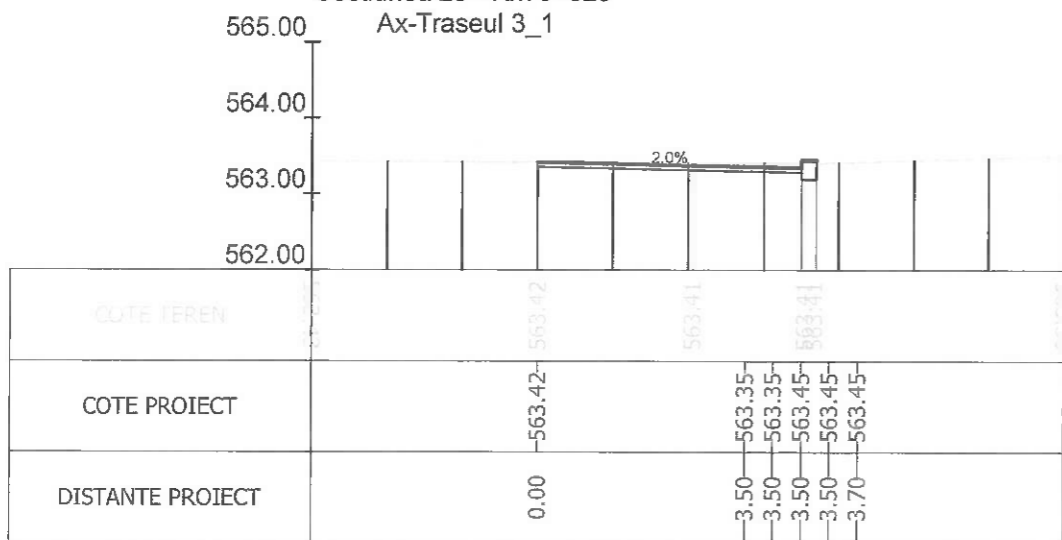

Sectiunea 26 - Km 0+350
Ax-Traseul 3_1

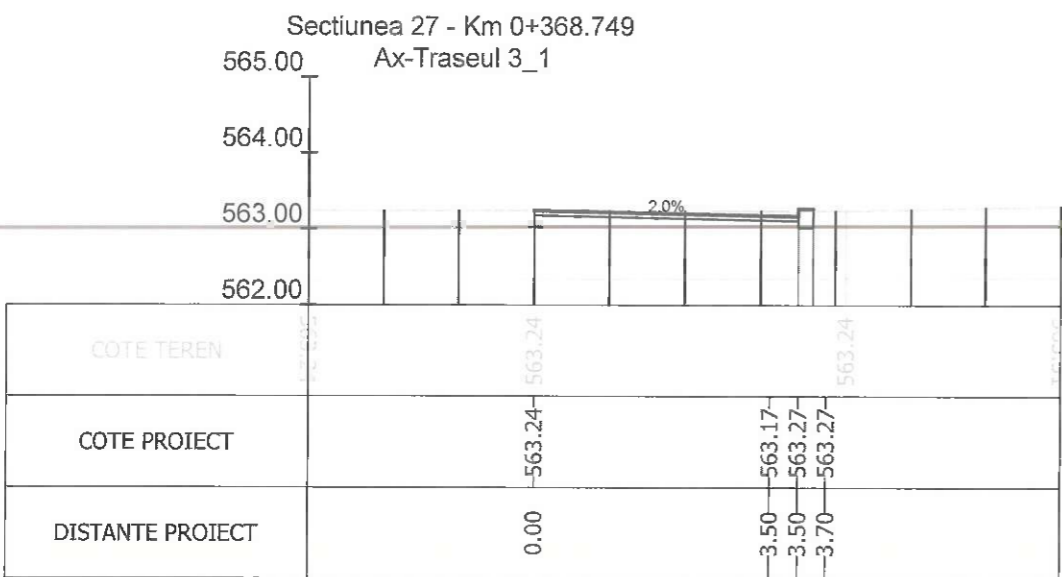
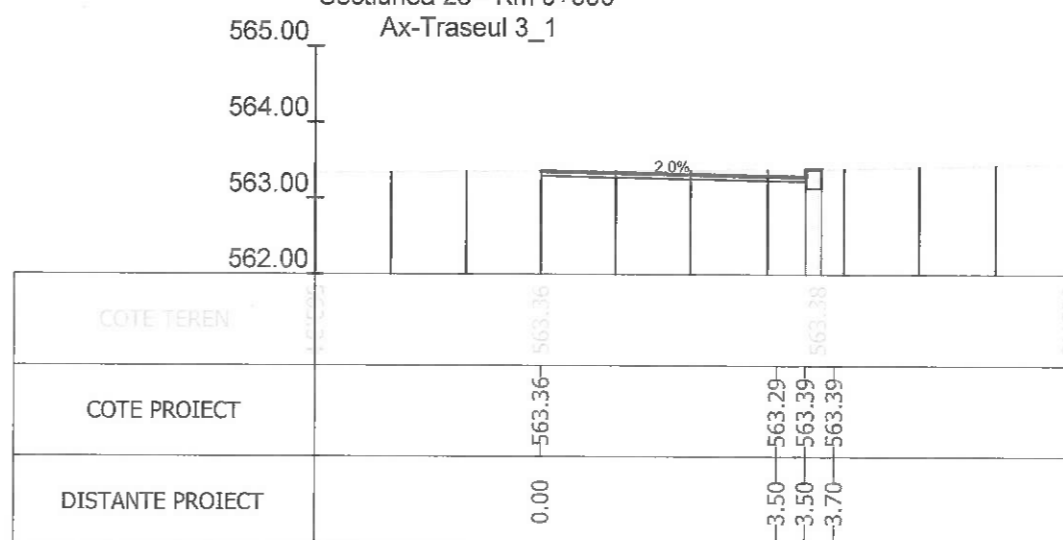

Sectiunea 27 - Km 0+368.749
Ax-Traseul 3_1

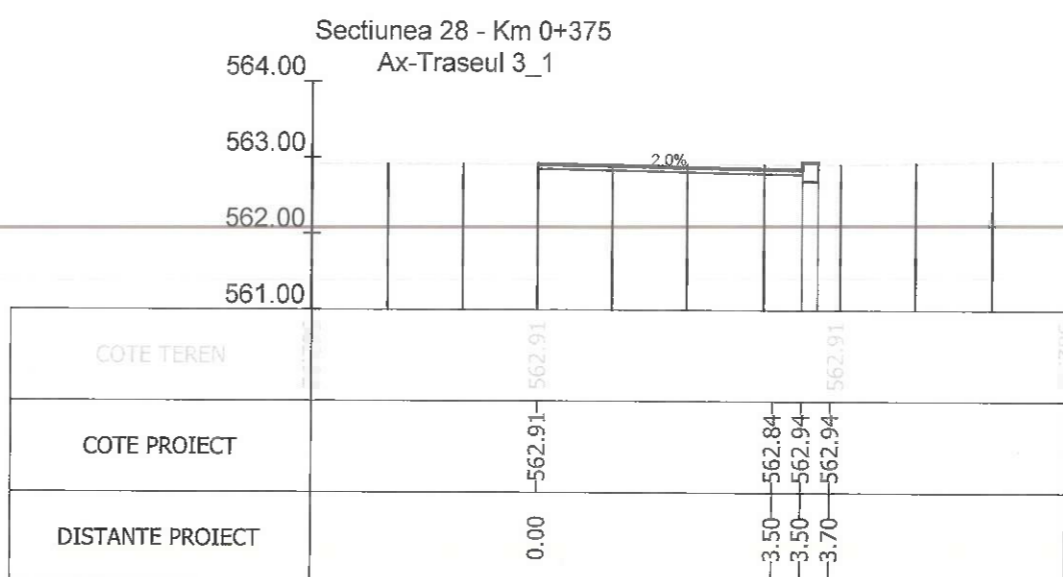

Sectiunea 28 - Km 0+375
Ax-Traseul 3_1

Sectiunea 29 - Km 0+400
Ax-Traseul 3_1

Sectiunea 30 - Km 0+425
Ax-Traseul 3_1



Index A	Ax-Traseul 3_1		Rev. 5
		Beneficiar:	MUNICIPIUL BRASOV Bulevardul Eroilor 8, Brasov 500007
Sef Proiect: Ing. A. Buta Proiectat: Ing. A. Buta Desenat: Ing. S. Patroi Verificat:		Titlu proiect:	AMENAJARE BENZI DEDICATE TRANSPORTULUI PUBLIC IN MUNICIPIUL BRASOV SI TROTUARE ADIACENTE
Scara: 1/100 Data: 07/2023		Titlu plansa:	PROFILE TRANSVERSALE CURENTE
		Nr. proiect:	73 / 2020
		Faza P.T.:	
		Nr. plansa:	PT-140

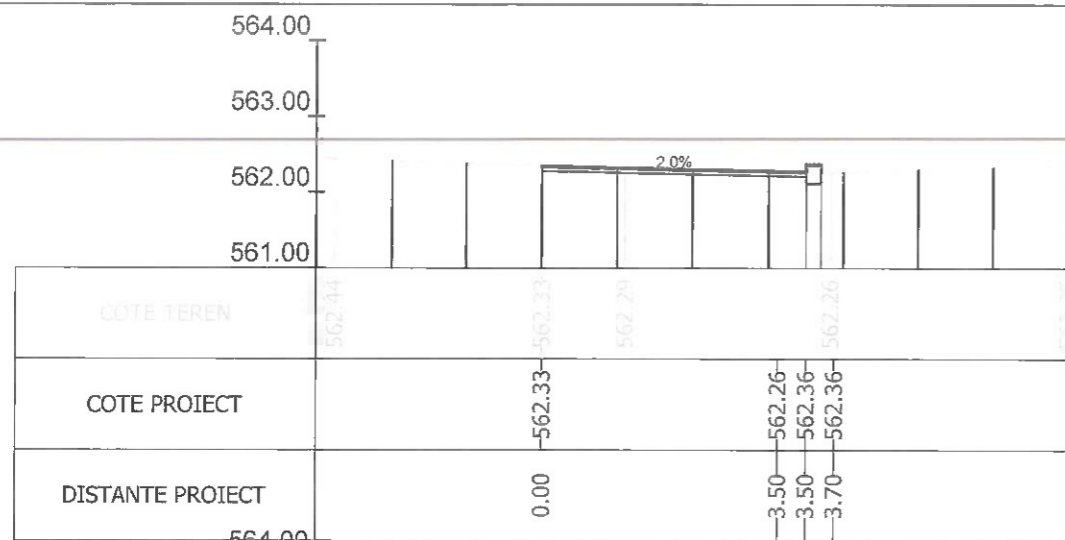

Sectiunea 37 - Km 0+482.969
Ax-Traseul 3_1

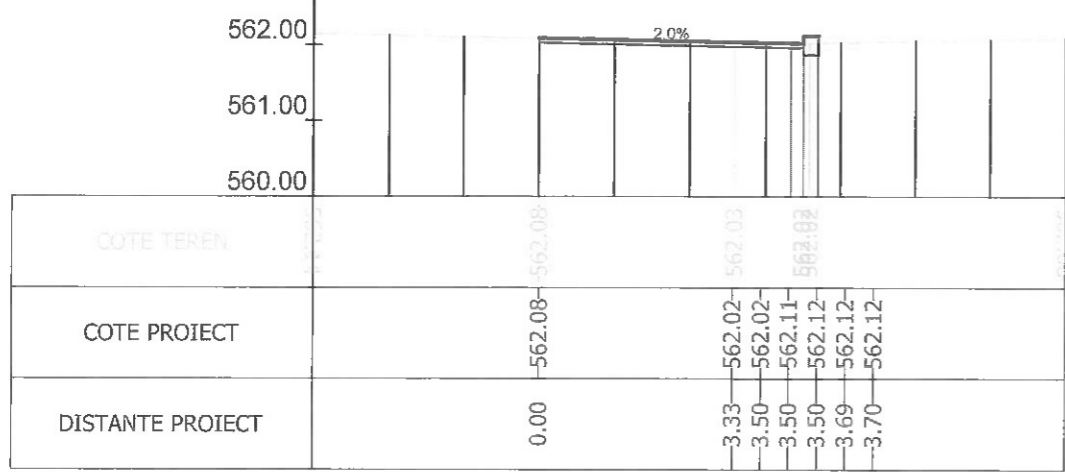

Sectiunea 39 - Km 0+506.847
Ax-Traseul 3_1

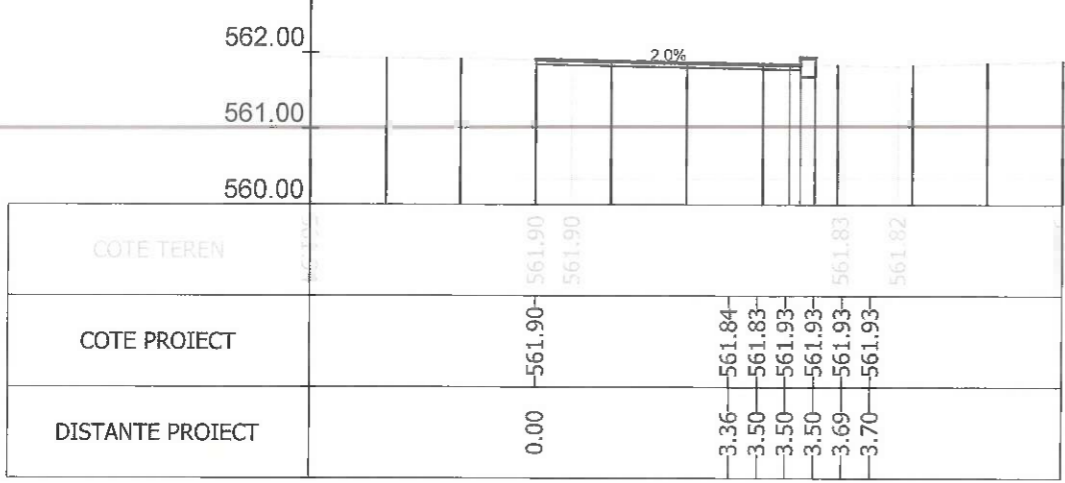

Sectiunea 41 - Km 0+532.427
Ax-Traseul 3_1

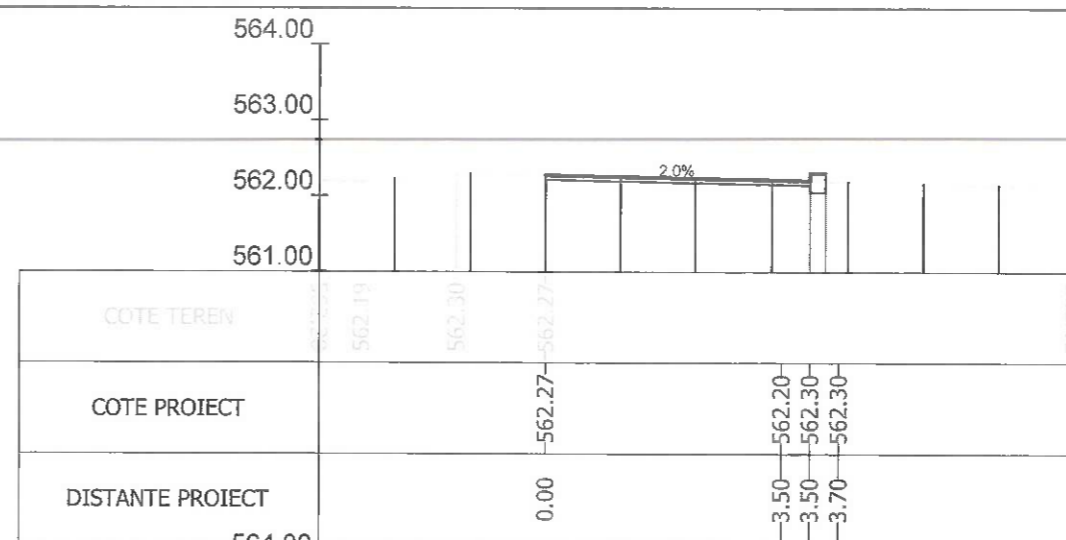

Sectiunea 38 - Km 0+500
Ax-Traseul 3_1

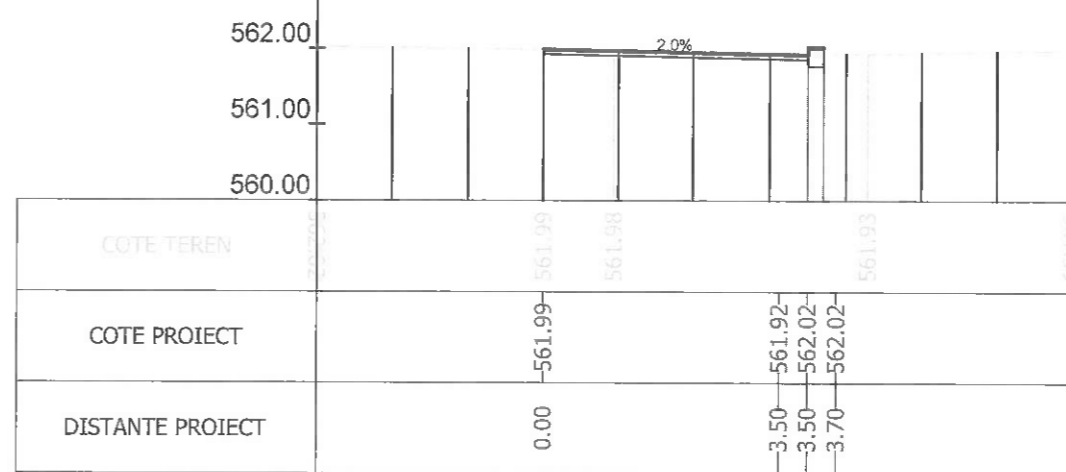

Sectiunea 40 - Km 0+525
Ax-Traseul 3_1

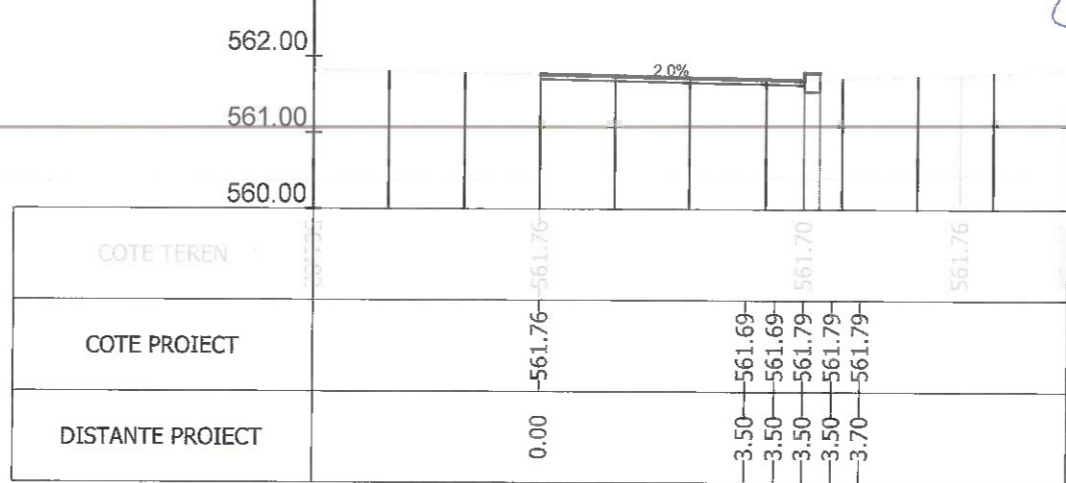

Sectiunea 42 - Km 0+539.207
Ax-Traseul 3_1

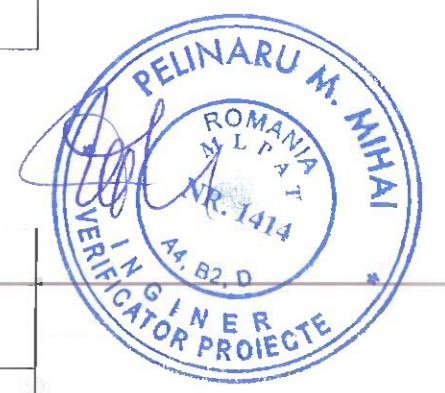

Index	A	Rev. 5
		Beneficiar: MUNICIPIUL BRASOV Bulevardul Eroilor 8, Brasov 500007
Titlu proiect: AMENAJARE BENZI DEDICATE TRANSPORTULUI PUBLIC IN MUNICIPIUL BRASOV SI TROTUARE ADIACENTE		Nr. proiect: 73 / 2020
Titlu plansa: PROFILE TRANSVERSALE CURENTE		Faza P.T. Nr. plansa PT-142
Sef Proiect	Ing. A. Buta	Scara 1/100
Proiectat	Ing. A. Buta	Data 07/2023
Desenat	Ing. S. Patroi	
Verificat		

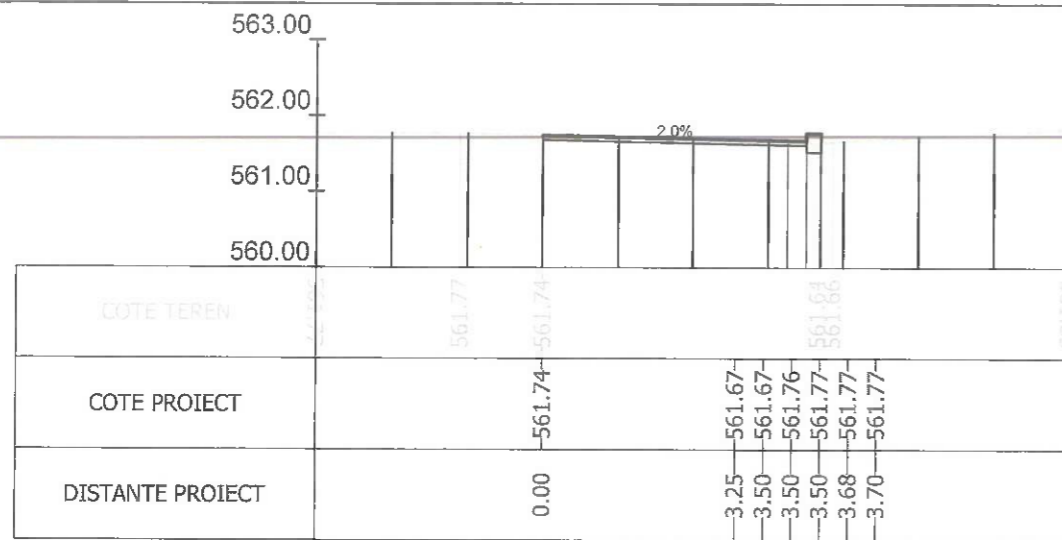

Sectiunea 43 - Km 0+544.295
Ax-Traseul 3_1

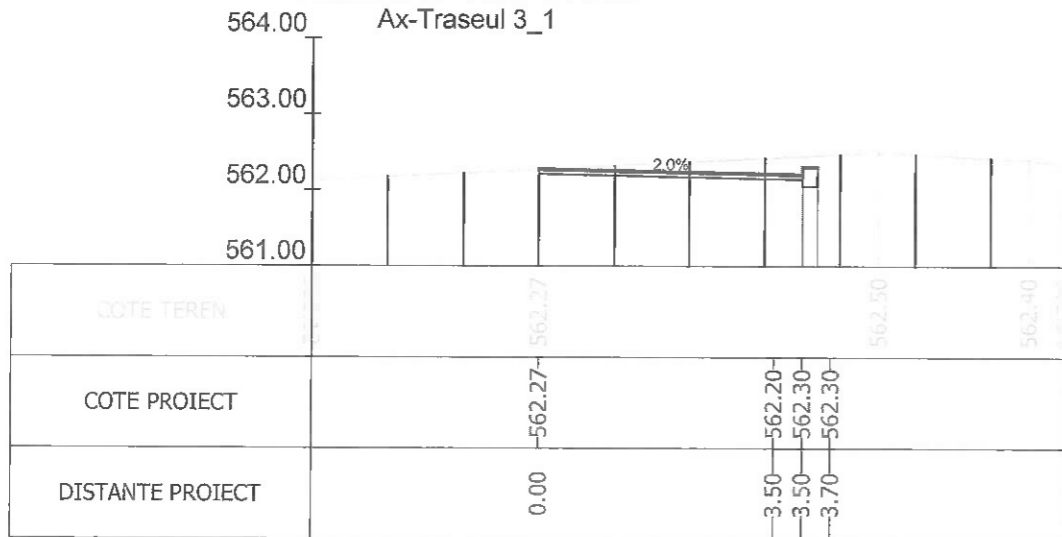

Sectiunea 45 - Km 0+575
Ax-Traseul 3_1

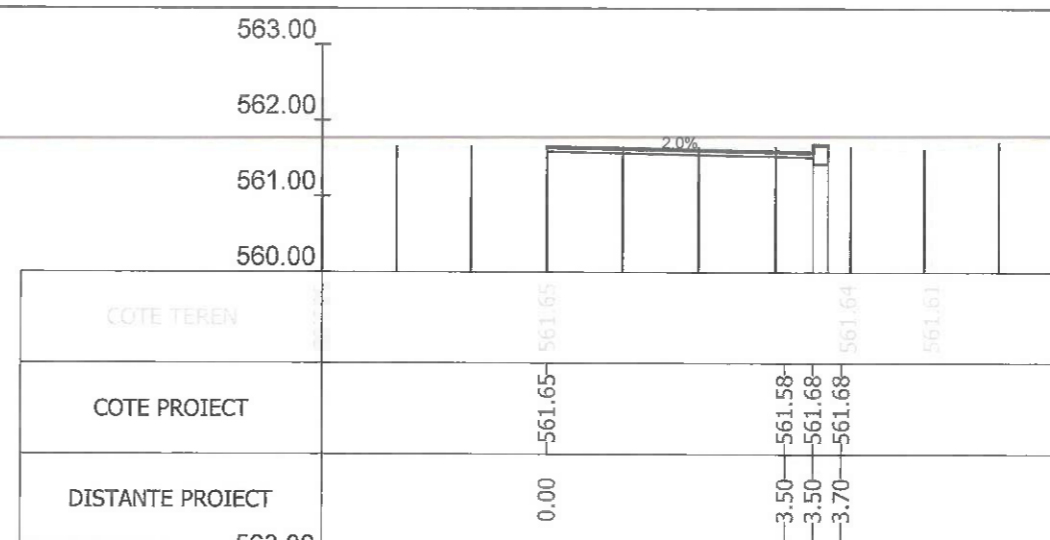

Sectiunea 44 - Km 0+550
Ax-Traseul 3_1

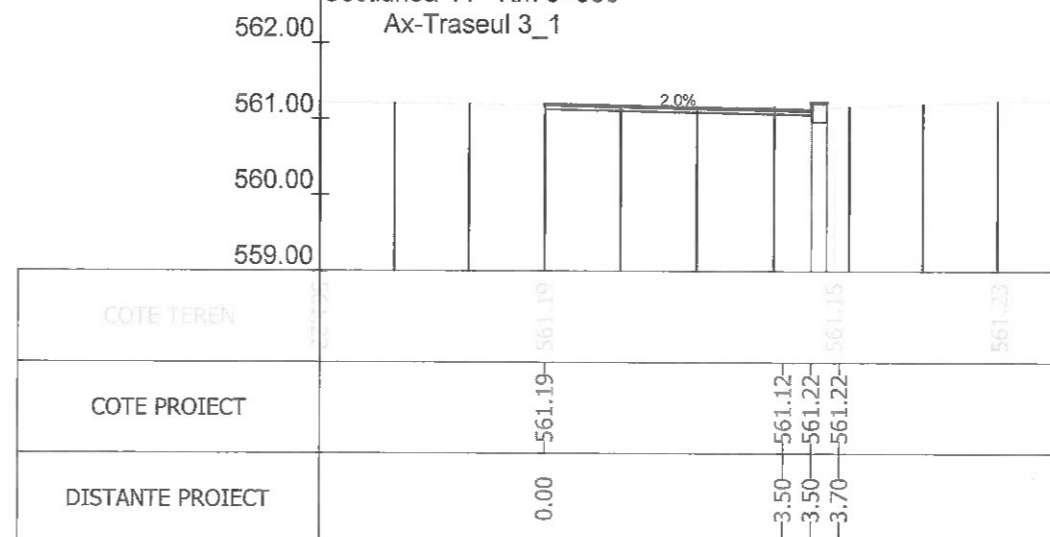

Sectiunea 46 - Km 0+600
Ax-Traseul 3_1



Index	Data	Observatii	Rev. 5
A			
		Beneficiar:	MUNICIPIUL BRASOV Bulevardul Eroilor 8, Brasov 500007
Sef Proiect: Ing. A. Buta Proiectat: Ing. A. Buta Desenat: Ing. S. Patroi Verificat:		Titlu proiect:	AMENAJARE BENZI DEDICATE TRANSPORTULUI PUBLIC IN MUNICIPIUL BRASOV SI TROTUARE ADIACENTE
Scara: 1/100 Data: 07/2023		Titlu plansa:	PROFILE TRANSVERSALE CURENTE
		Nr. proiect	73 / 2020
		Faza	P.T.
		Nr. plansa	PT-143

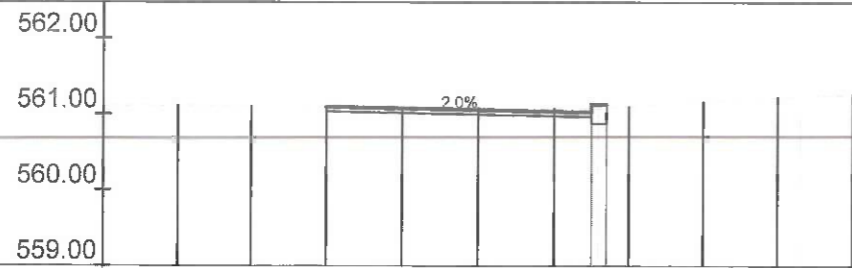

COTE TEREN		561.10		561.07	561.24
COTE PROIECT		561.10	561.03	561.13	561.13
DISTANTE PROIECT		0.00	3.50	3.50	3.70

Sectiunea 47 - Km 0+614.021
Ax-Traseul 3_1

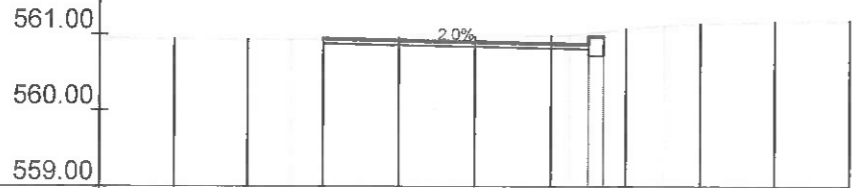

COTE TEREN		560.93	560.94	560.99	561.12	561.17
COTE PROIECT		560.94	560.87	560.97	560.97	560.97
DISTANTE PROIECT		0.00	3.50	3.50	3.70	3.70

Sectiunea 49 - Km 0+625
Ax-Traseul 3_1

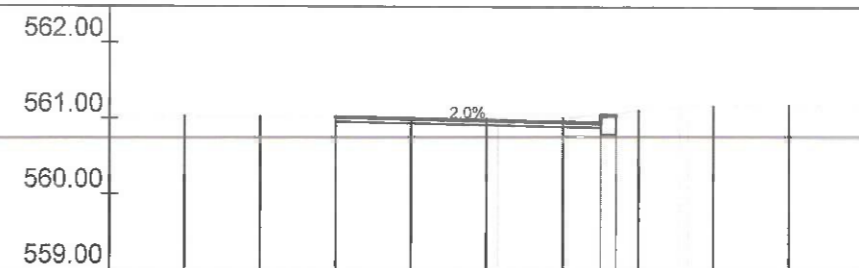

COTE TEREN		561.02		561.00	561.02	561.17
COTE PROIECT		561.02		560.95	561.05	561.05
DISTANTE PROIECT		0.00		3.50	3.50	3.70

Sectiunea 48 - Km 0+623.511
Ax-Traseul 3_1

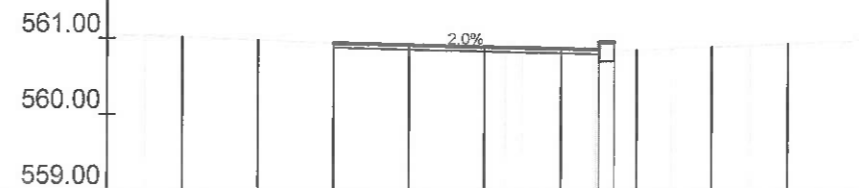

COTE TEREN		561.04	560.94	560.86	560.83	560.85	560.89	560.94
COTE PROIECT		560.94	560.94	560.87	560.97	560.97	560.97	560.94
DISTANTE PROIECT		0.00	0.00	3.50	3.50	3.70	3.70	3.70

Sectiunea 50 - Km 0+633
Ax-Traseul 3_1

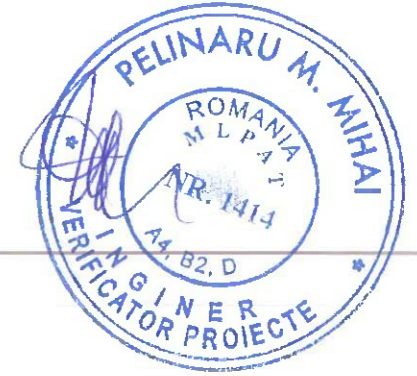

Index	Data	Observatii	Rev. 5
A			
		Beneficiar:	MUNICIPIUL BRASOV Bulevardul Eroilor 8, Brasov 500007
Sef Proiect: Ing. A. Buta Proiectat: Ing. A. Buta Desenat: Ing. S. Patroi Verificat:		Scara:	1/100
		Data:	07/2023
		Titlu proiect:	AMENAJARE BENZI DEDICATE TRANSPORTULUI PUBLIC IN MUNICIPIUL BRASOV SI TROTUARE ADIACENTE
		Titlu plansa:	PROFILE TRANSVERSALE CURENTE
		Nr. proiect:	73 / 2020
		Faza:	P.T.
		Nr. plansa:	PT-144

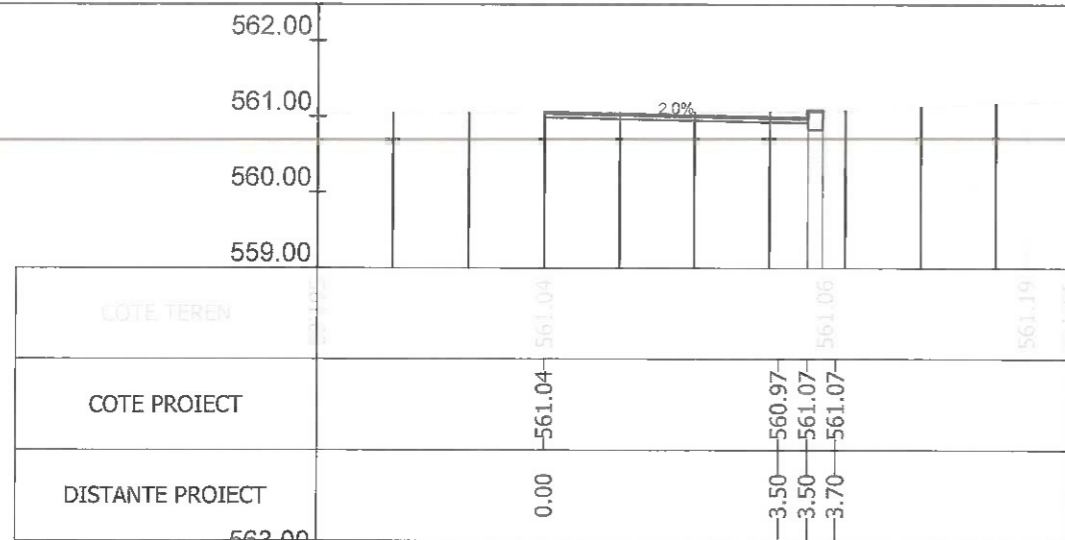

Sectiunea 1 - Km 0+000
Ax-Traseul 3_2

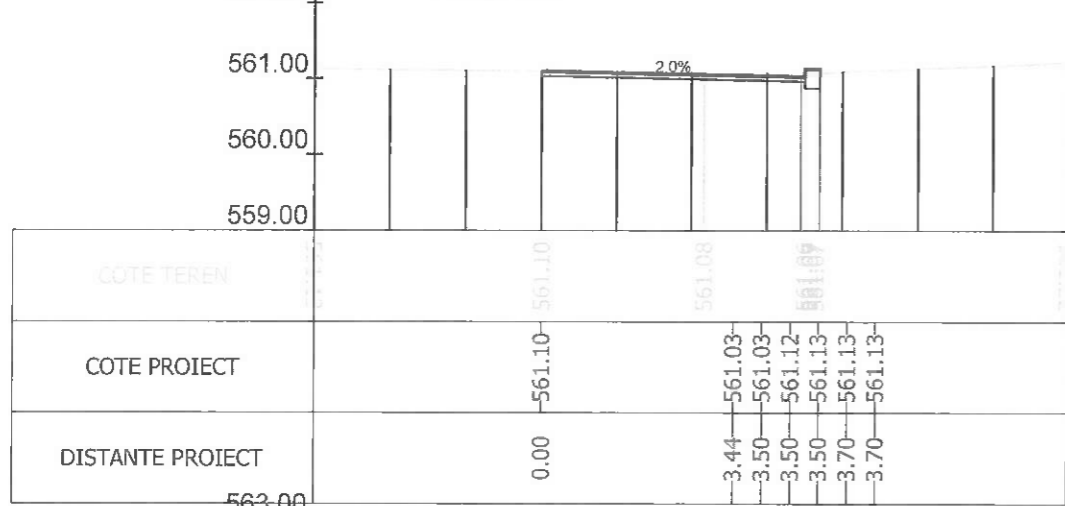

Sectiunea 3 - Km 0+017.825
Ax-Traseul 3_2

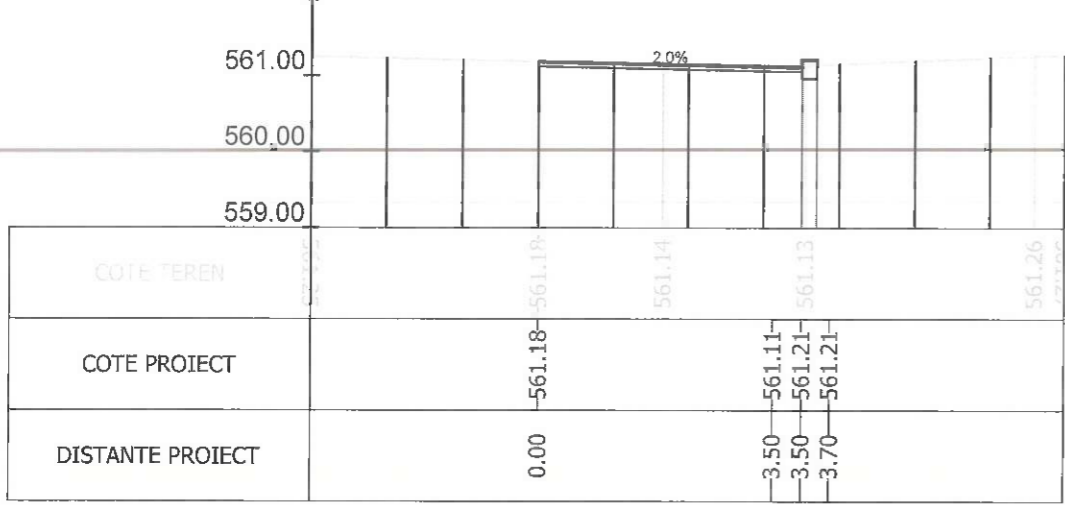

Sectiunea 5 - Km 0+025
Ax-Traseul 3_2

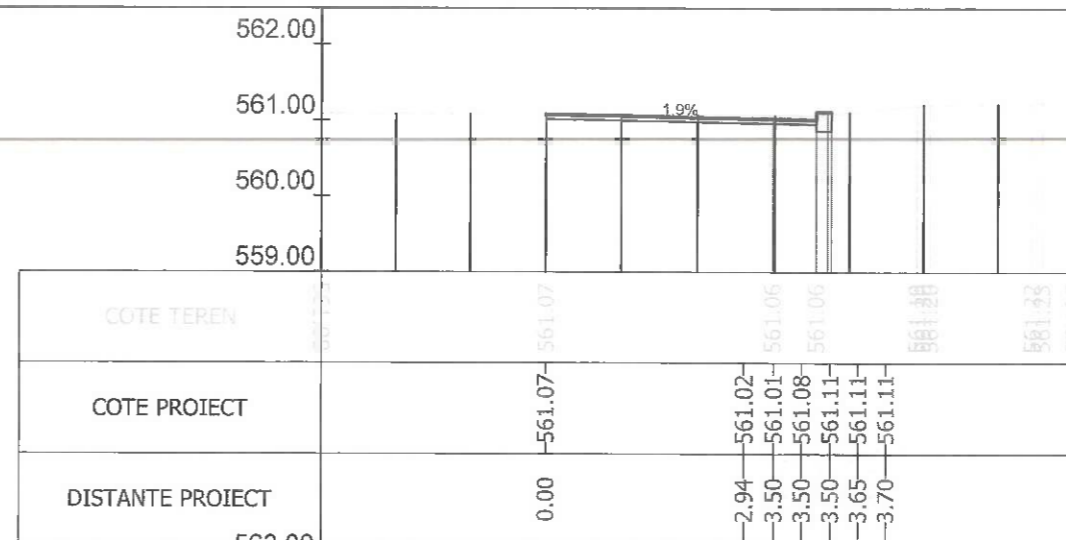

Sectiunea 2 - Km 0+010.322
Ax-Traseul 3_2

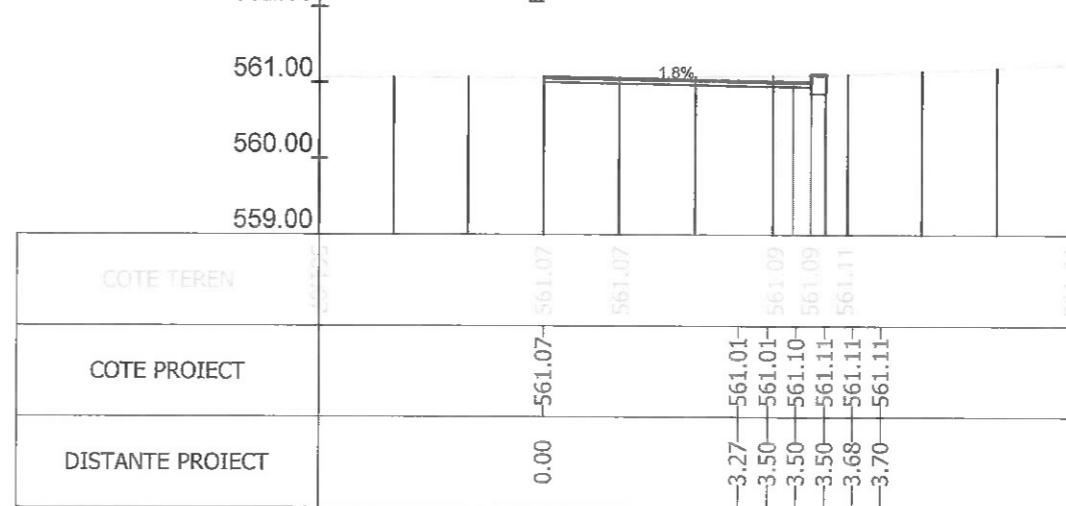

Sectiunea 4 - Km 0+021.847
Ax-Traseul 3_2

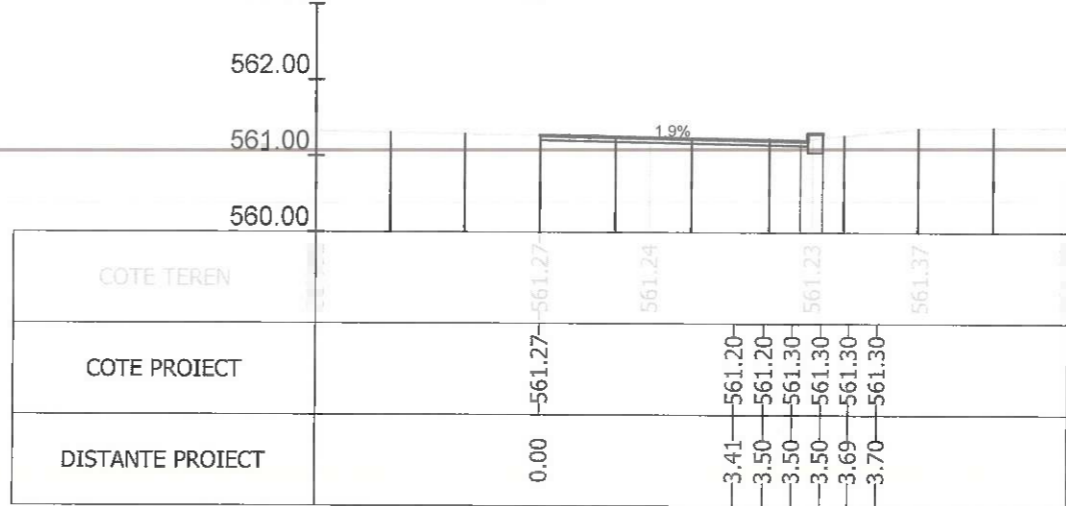

Sectiunea 6 - Km 0+039.365
Ax-Traseul 3_2



Index	A	Rev. 5
		Beneficiar: MUNICIPIUL BRASOV Bulevardul Eroilor 8, Brasov 500007
Sef Proiect: Ing. A. Buta Proiectat: Ing. A. Buta Desenat: Ing. S. Patroi Verificat:		Nr. proiect: 73 / 2020 Faza: P.T. Nr. plansa: PT-145
Scara: 1/100 Data: 07/2023		Titlu proiect: AMENAJARE BENZI DEDICATE TRANSPORTULUI PUBLIC IN MUNICIPIUL BRASOV SI TROTUARE ADIACENTE Titlu plansa: PROFILE TRANSVERSALE CURENTE

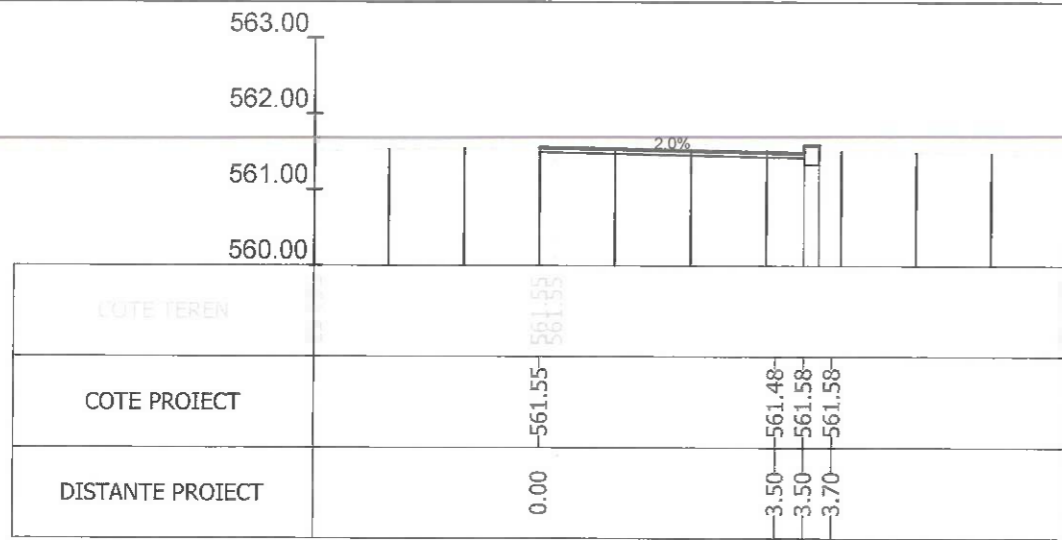

Sectiunea 7 - Km 0+050
Ax-Traseul 3_2

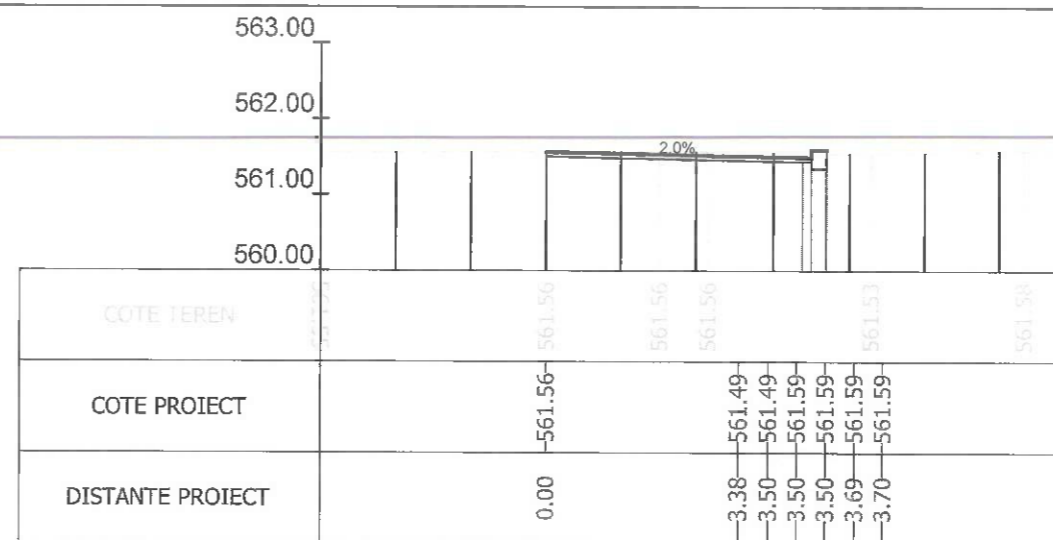

Sectiunea 8 - Km 0+074.373
Ax-Traseul 3_2

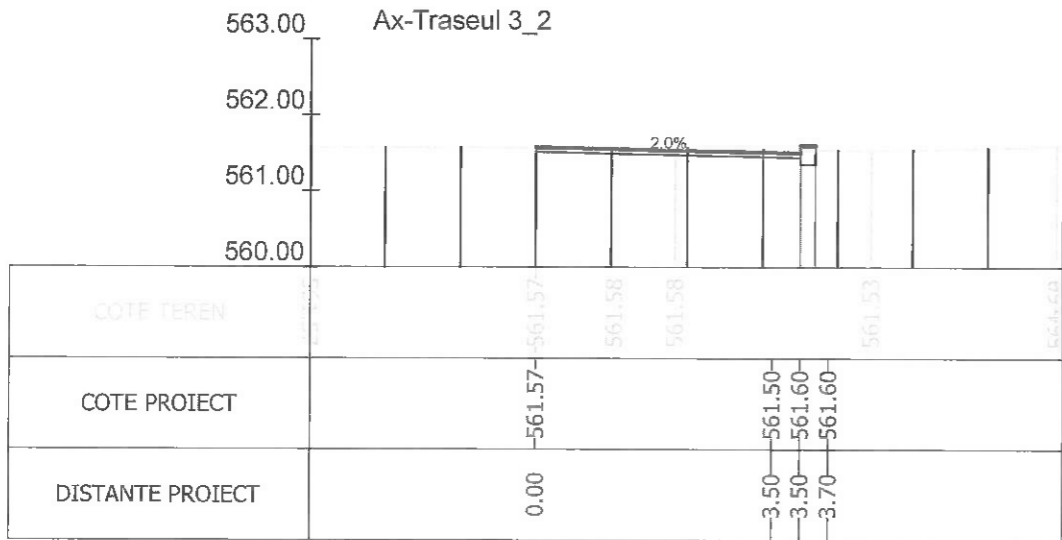

Sectiunea 9 - Km 0+075
Ax-Traseul 3_2

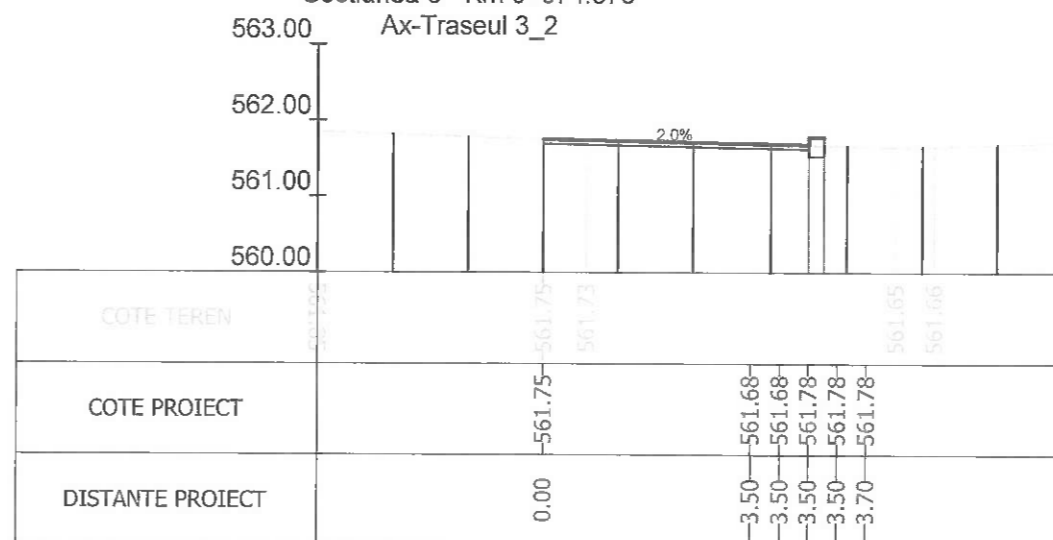

Sectiunea 10 - Km 0+090.896
Ax-Traseul 3_2

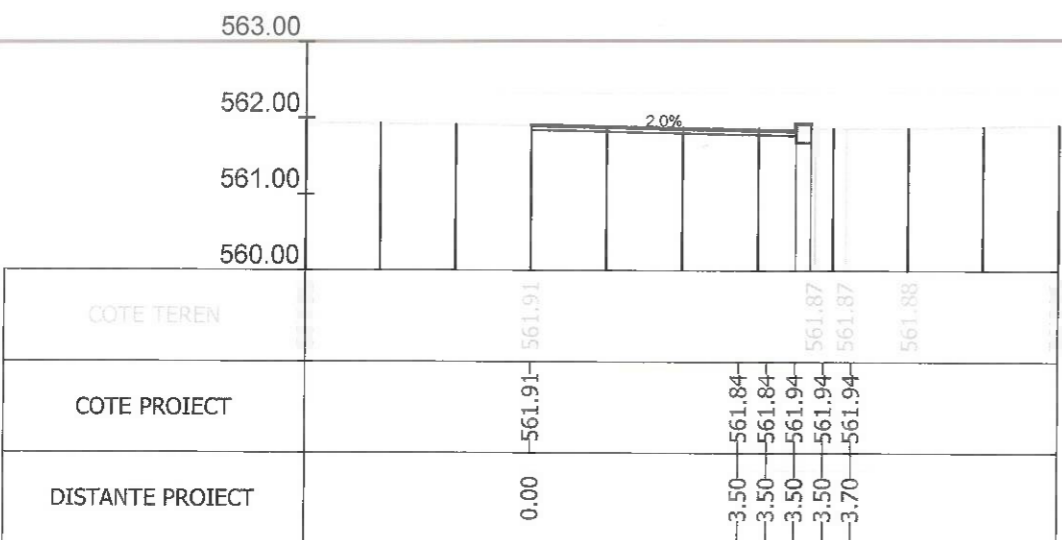

Sectiunea 11 - Km 0+097.873
Ax-Traseul 3_2



Sectiunea 12 - Km 0+100
Ax-Traseul 3_2



Index	A	Rev. 5
		Beneficiar:
Sef Proiect: Ing. A. Buta Proiectat: Ing. A. Buta Desenat: Ing. S. Patroi Verificat:		MUNICIPIUL BRASOV Bulevardul Eroilor 8, Brasov 500007
Scara: 1/100 Data: 07/2023		Nr. proiect: 73 / 2020 Faza P.T.
		Titlu proiect: AMENAJARE BENZI DEDICATE TRANSPORTULUI PUBLIC IN MUNICIPIUL BRASOV SI TROTUARE ADIACENTE Titlu plansa: PROFILE TRANSVERSALE CURENTE
		Nr. plansa: PT-146

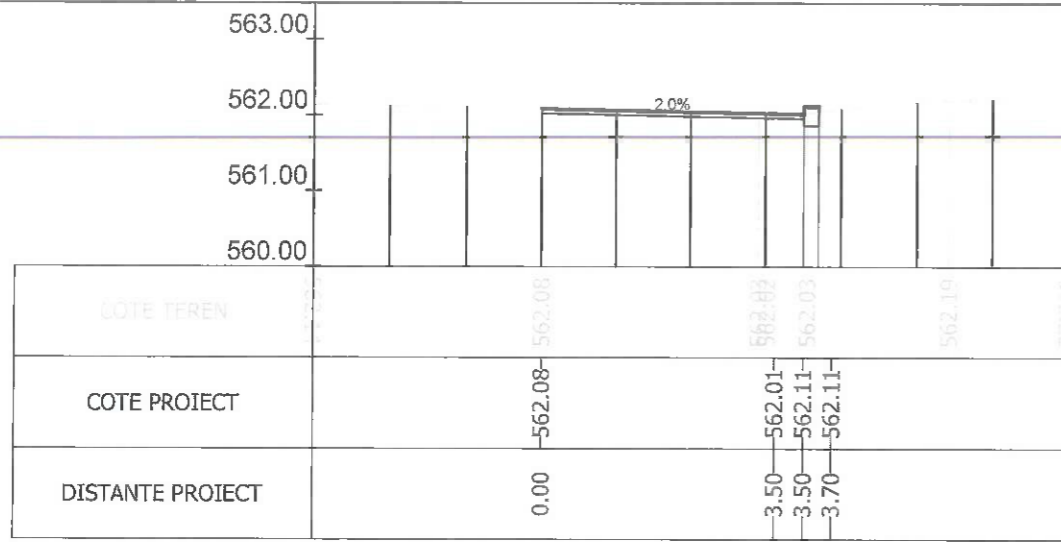

Sectiunea 13 - Km 0+125
Ax-Traseul 3_2

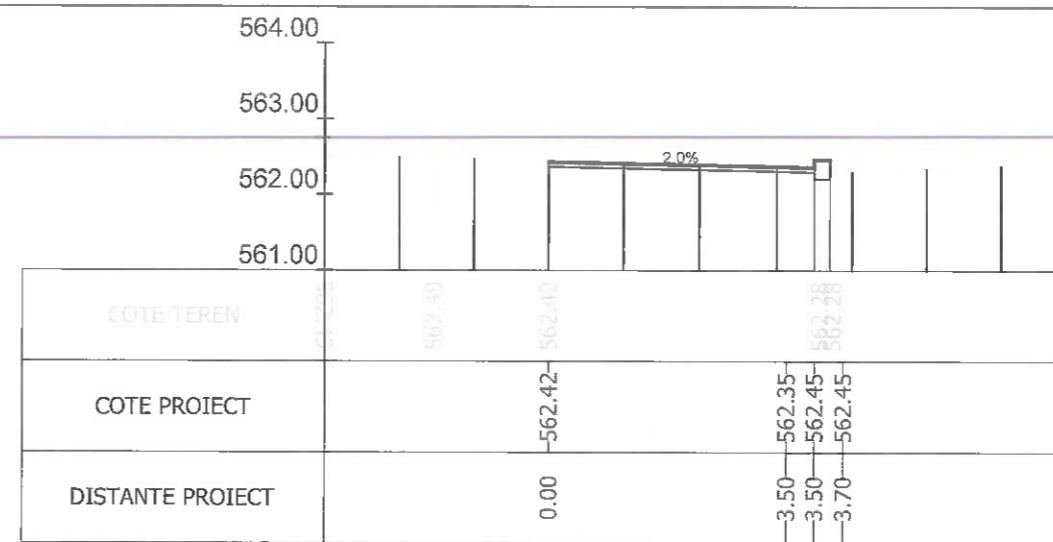

Sectiunea 14 - Km 0+150
Ax-Traseul 3_2

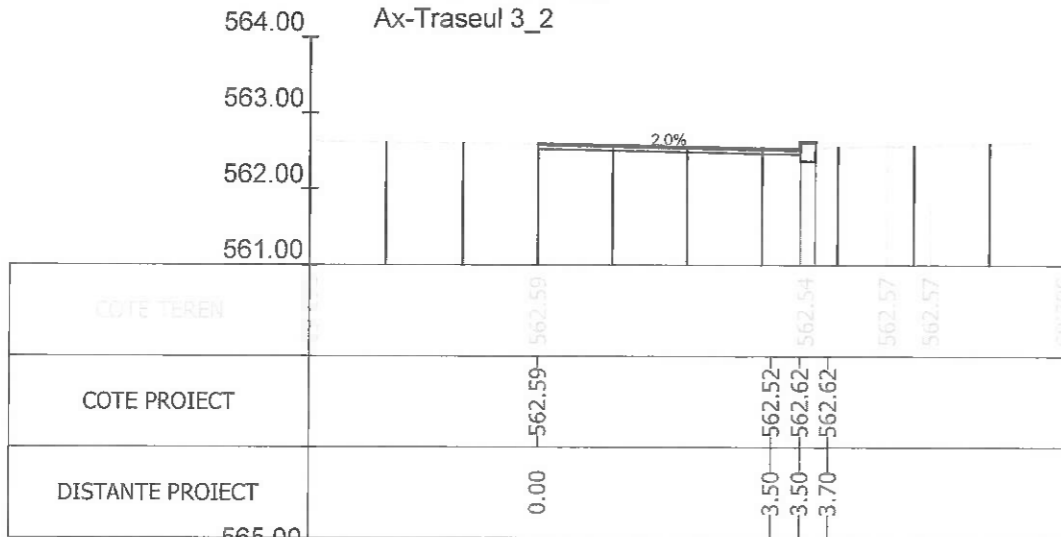

Sectiunea 15 - Km 0+175
Ax-Traseul 3_2

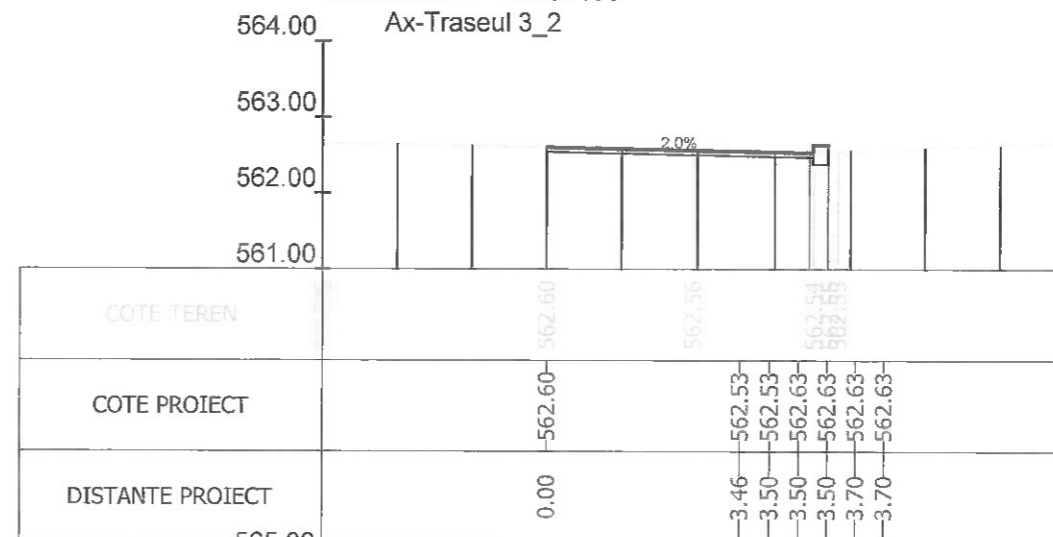

Sectiunea 16 - Km 0+176.633
Ax-Traseul 3_2

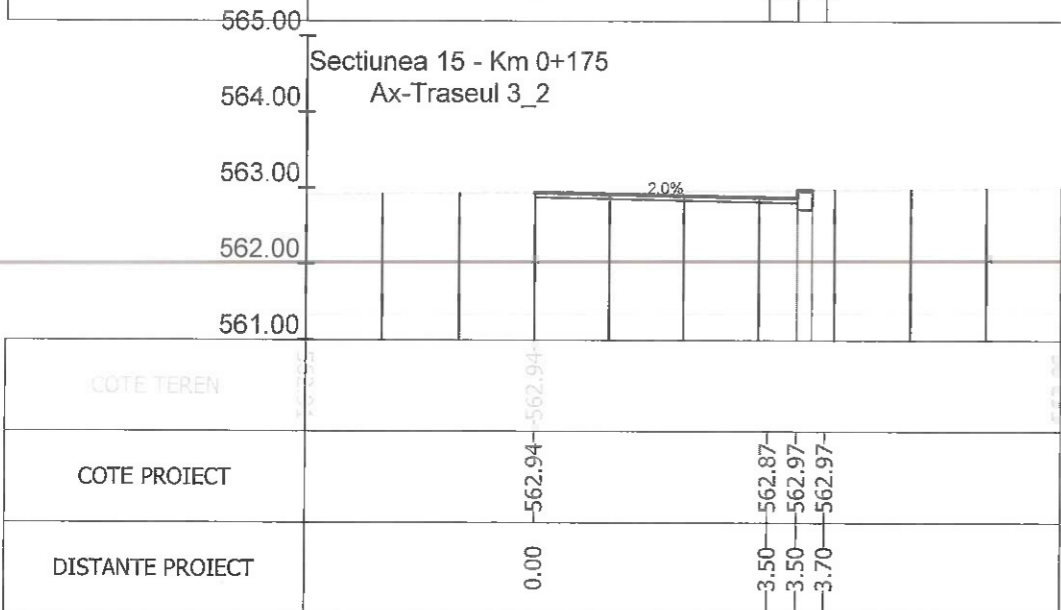

Sectiunea 17 - Km 0+200
Ax-Traseul 3_2

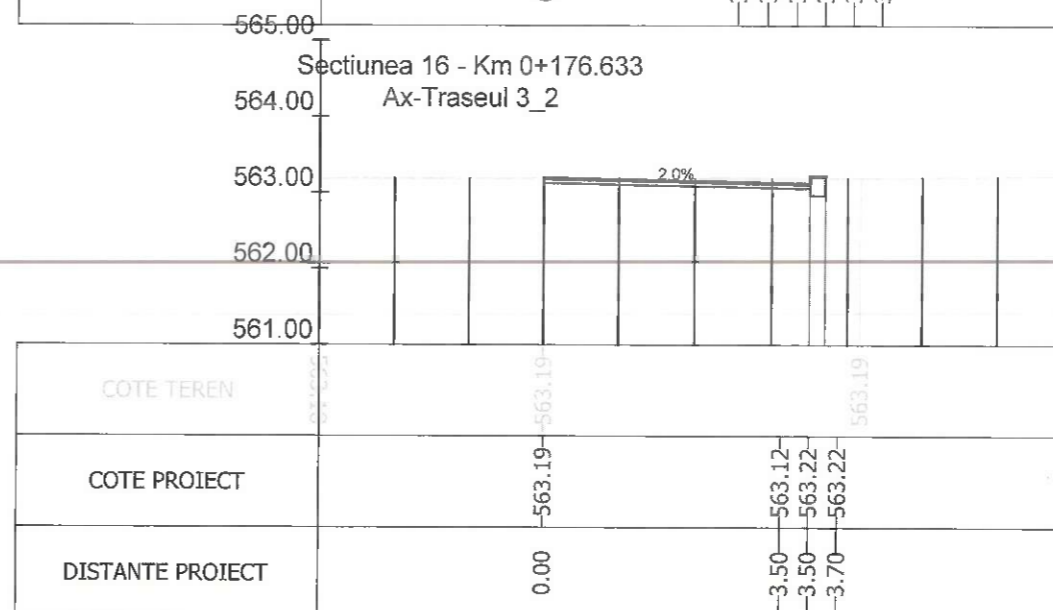

Sectiunea 18 - Km 0+225
Ax-Traseul 3_2



Index	A	Rev. 5
		Beneficiar: MUNICIPIUL BRASOV Bulevardul Eroilor 8, Brasov 500007
Sef Proiect: Ing. A. Buta Proiectat: Ing. A. Buta Desenat: Ing. S. Patroi Verificat:		Nr. proiect: 73 / 2020 Faza P.T.
Scara: 1/100 Data: 07/2023		Nr. plansa: PT-147
Titlu proiect: AMENAJARE BENZI DEDICATE TRANSPORTULUI PUBLIC IN MUNICIPIUL BRASOV SI TROTUARE ADIACENTE		Titlu plansa: PROFILE TRANSVERSALE CURENTE

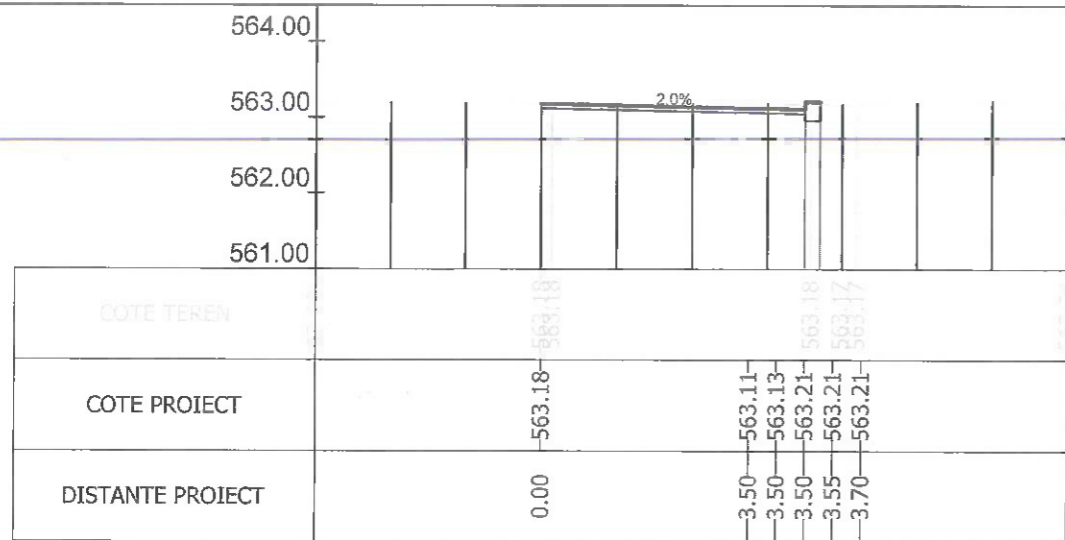

Sectiunea 19 - Km 0+239.632
Ax-Traseul 3_2

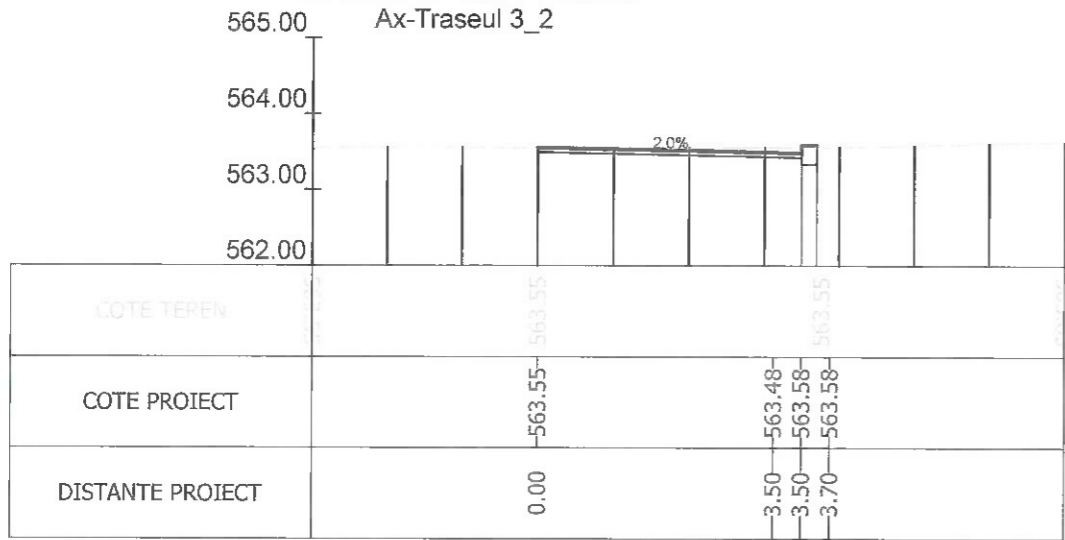

Sectiunea 21 - Km 0+275
Ax-Traseul 3_2

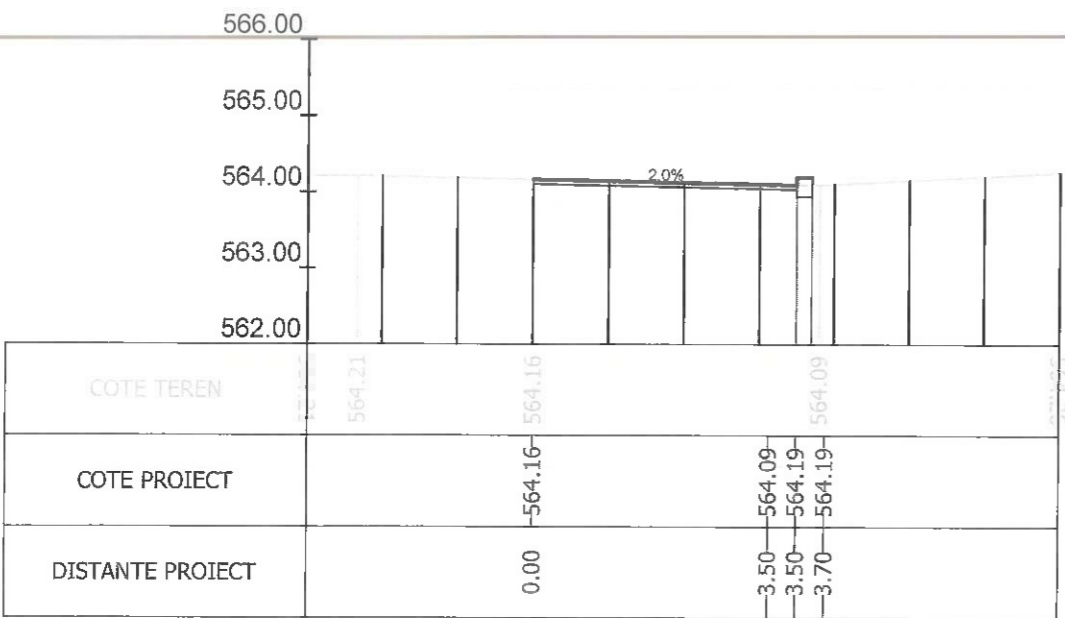

Sectiunea 23 - Km 0+325
Ax-Traseul 3_2

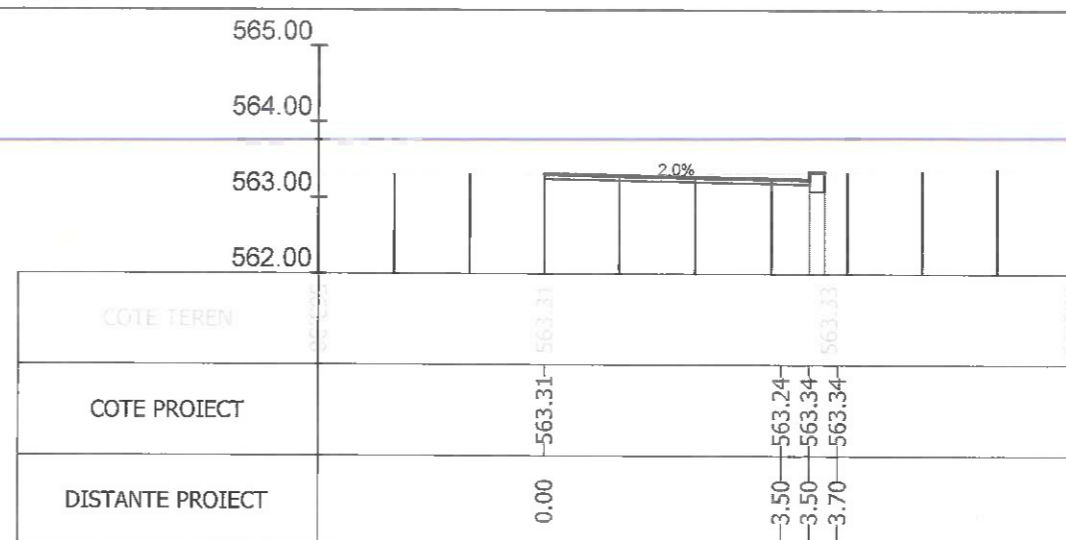

Sectiunea 20 - Km 0+250
Ax-Traseul 3_2

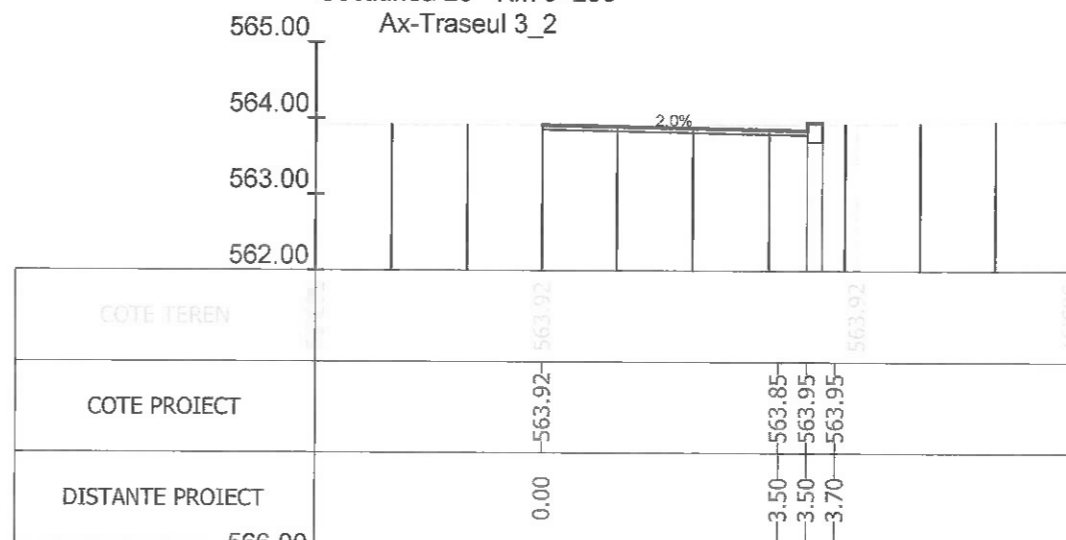

Sectiunea 22 - Km 0+300
Ax-Traseul 3_2

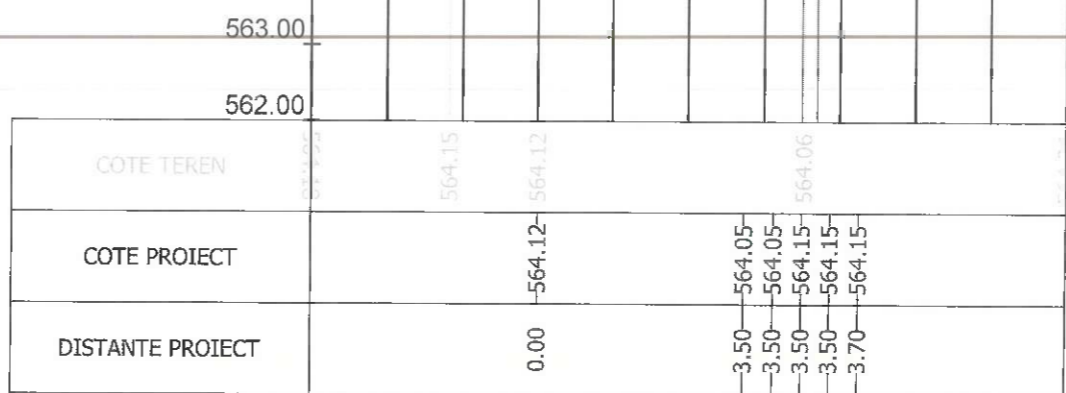

Sectiunea 24 - Km 0+329.038
Ax-Traseul 3_2

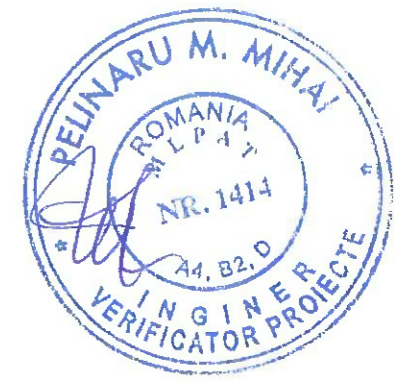

Index	A	Rev. 5
		Beneficiar:
Sef Proiect: Ing. A. Buta Proiectat: Ing. A. Buta Desenat: Ing. S. Patroi Verificat:		MUNICIPIUL BRASOV Bulevardul Eroilor 8, Brasov 500007
Scara: 1/100 Data: 07/2023		Nr. proiect: 73 / 2020 Faza: P.T. Nr. planșa: PT-148
Titlu proiect: AMENAJARE BENZI DEDICATE TRANSPORTULUI PUBLIC IN MUNICIPIUL BRASOV SI TROTUARE ADIACENTE Titlu planșa: PROFILE TRANSVERSALE CURENTE		

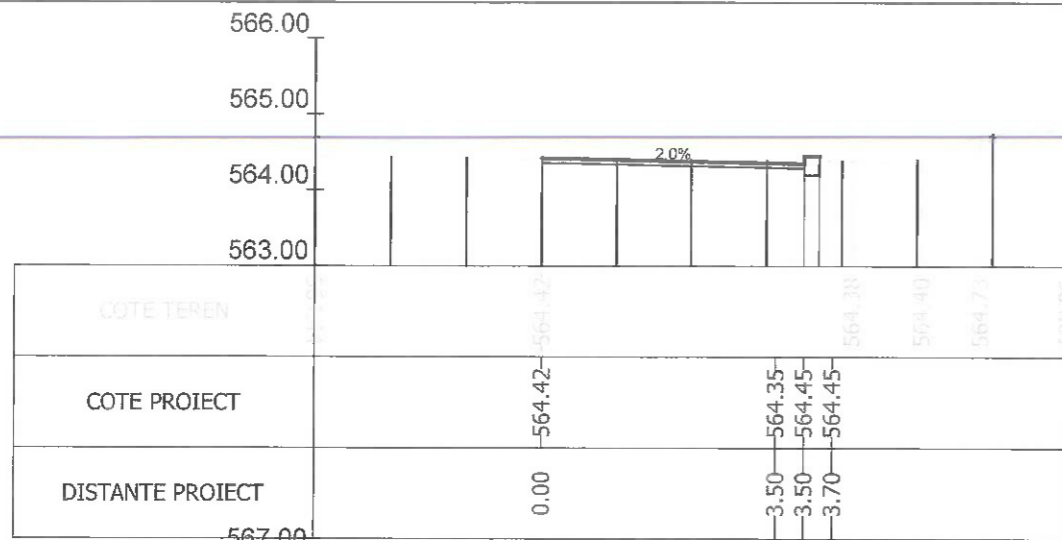

Sectiunea 25 - Km 0+350
Ax-Traseul 3_2

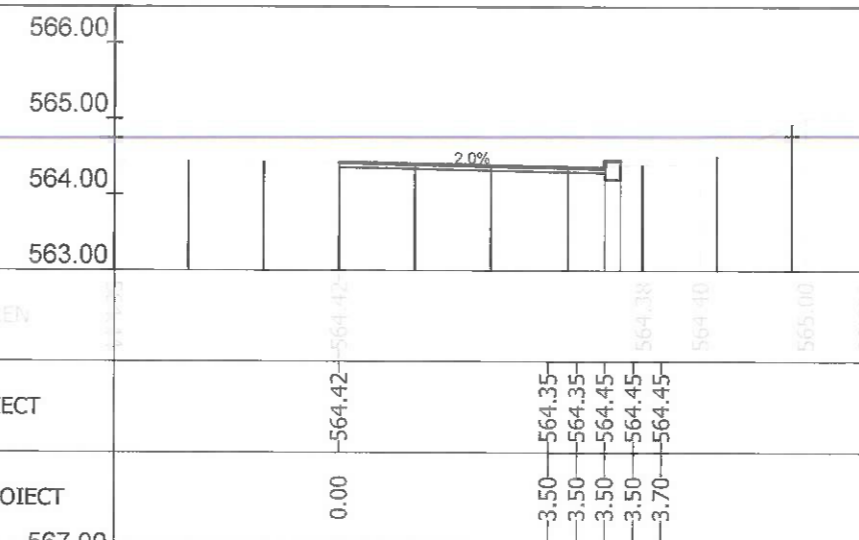
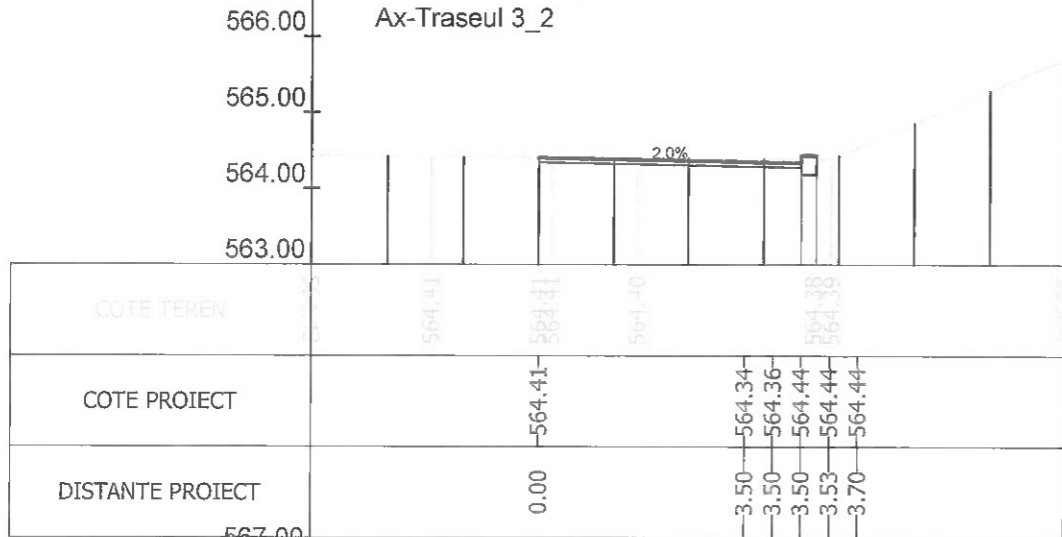

Sectiunea 26 - Km 0+351.950
Ax-Traseul 3_2

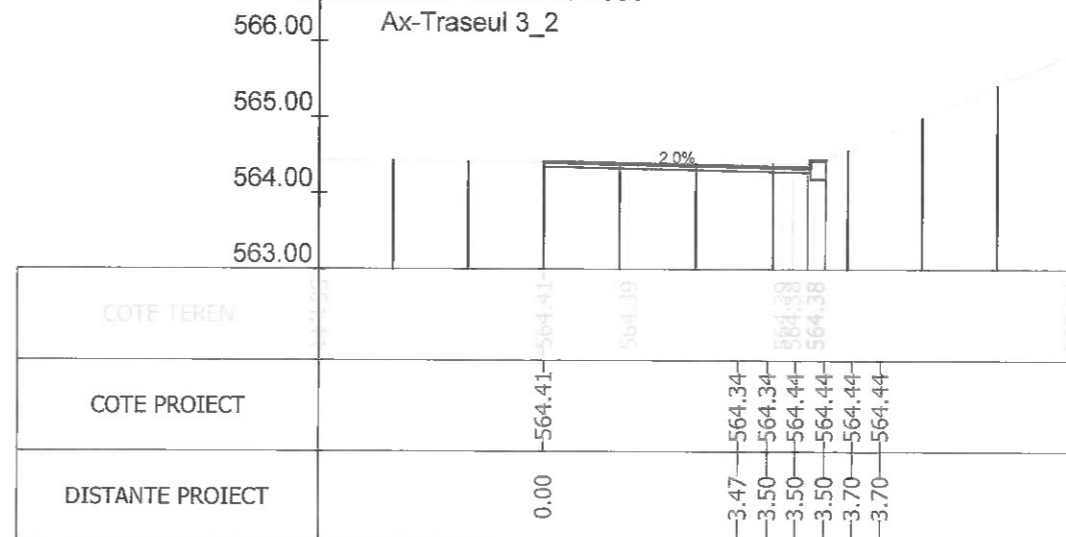

Sectiunea 27 - Km 0+358.010
Ax-Traseul 3_2

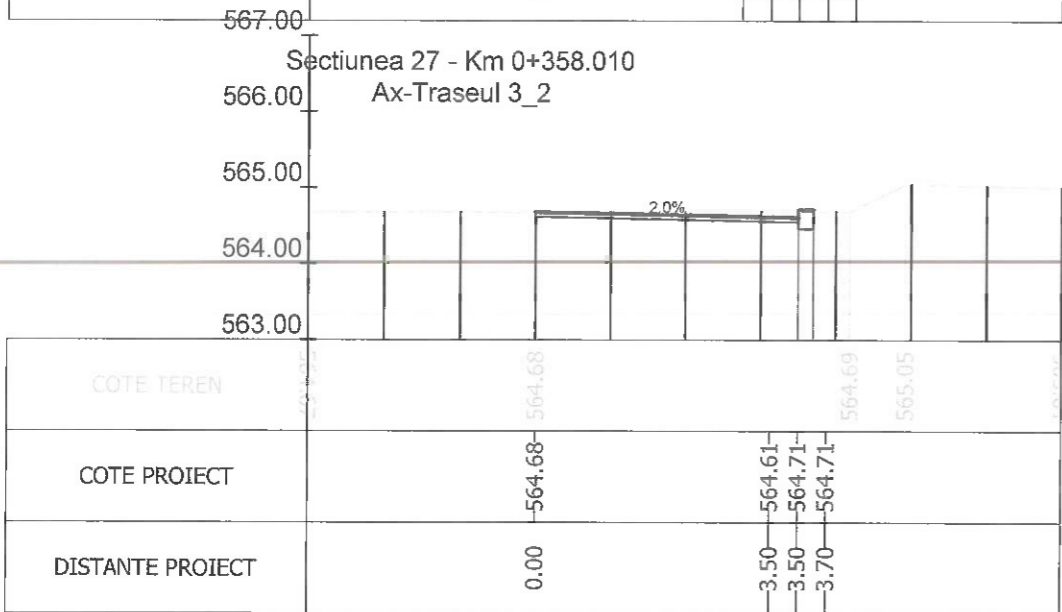

Sectiunea 28 - Km 0+360.345
Ax-Traseul 3_2

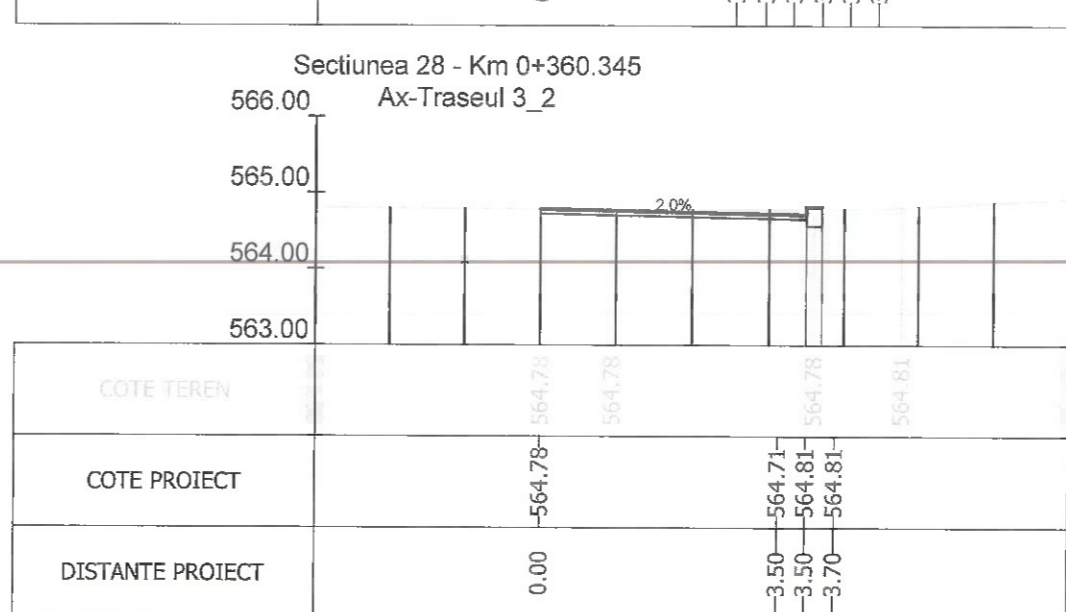

Sectiunea 29 - Km 0+375
Ax-Traseul 3_2

Index	A	Rev. 5
		Beneficiar:
Sef Proiect: Ing. A. Buta Proiectat: Ing. A. Buta Desenat: Ing. S. Patroi Verificat:		MUNICIPIUL BRASOV Bulevardul Eroilor 8, Brasov 500007
Scara: 1/100 Data: 07/2023		Nr. proiect: 73 / 2020 Faza P.T.
		Titlu proiect: AMENAJARE BENZI DEDICATE TRANSPORTULUI PUBLIC IN MUNICIPIUL BRASOV SI TROTUARE ADIACENTE Titlu plansa: PROFILE TRANSVERSALE CURENTE
		Nr. plansa PT-149

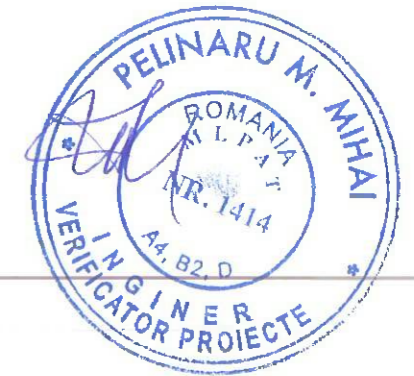

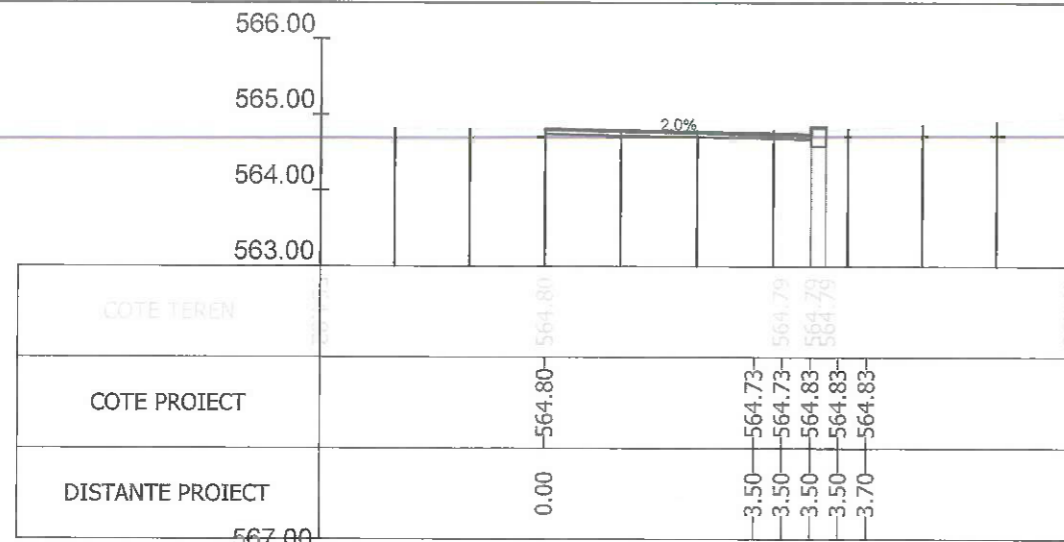

Sectiunea 31 - Km 0+402.090
Ax-Traseul 3_2

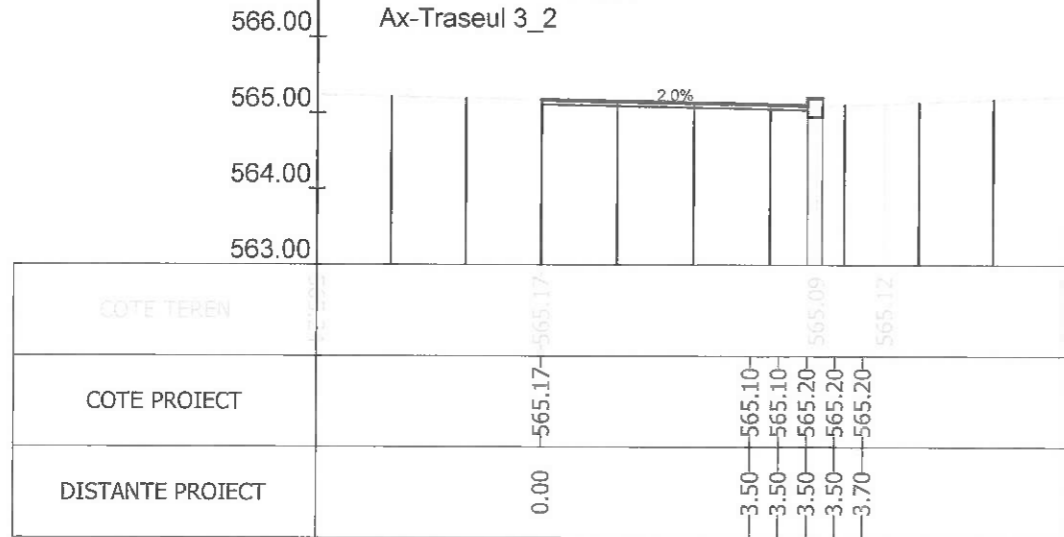

Sectiunea 32 - Km 0+425
Ax-Traseul 3_2

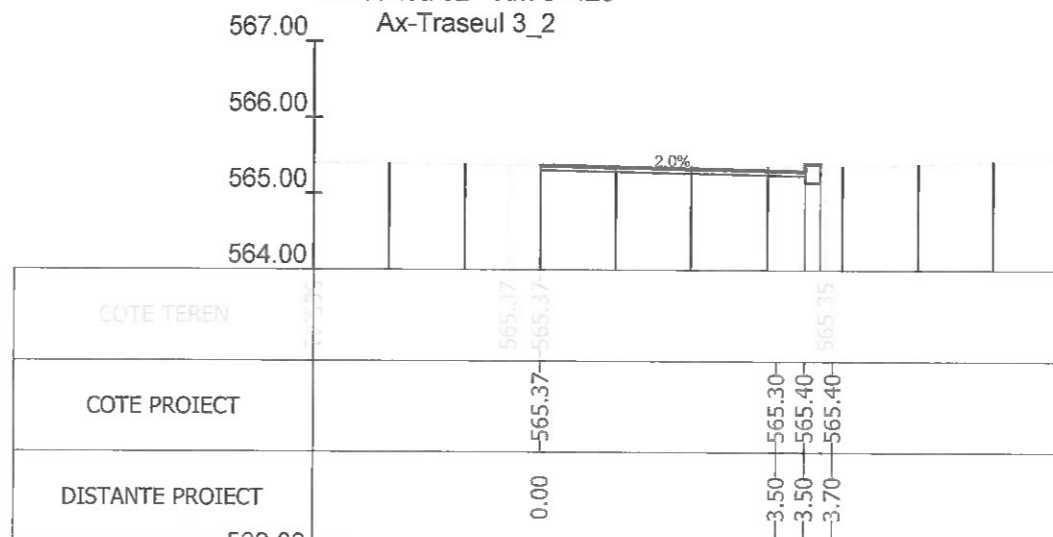

Sectiunea 33 - Km 0+431.692
Ax-Traseul 3_2

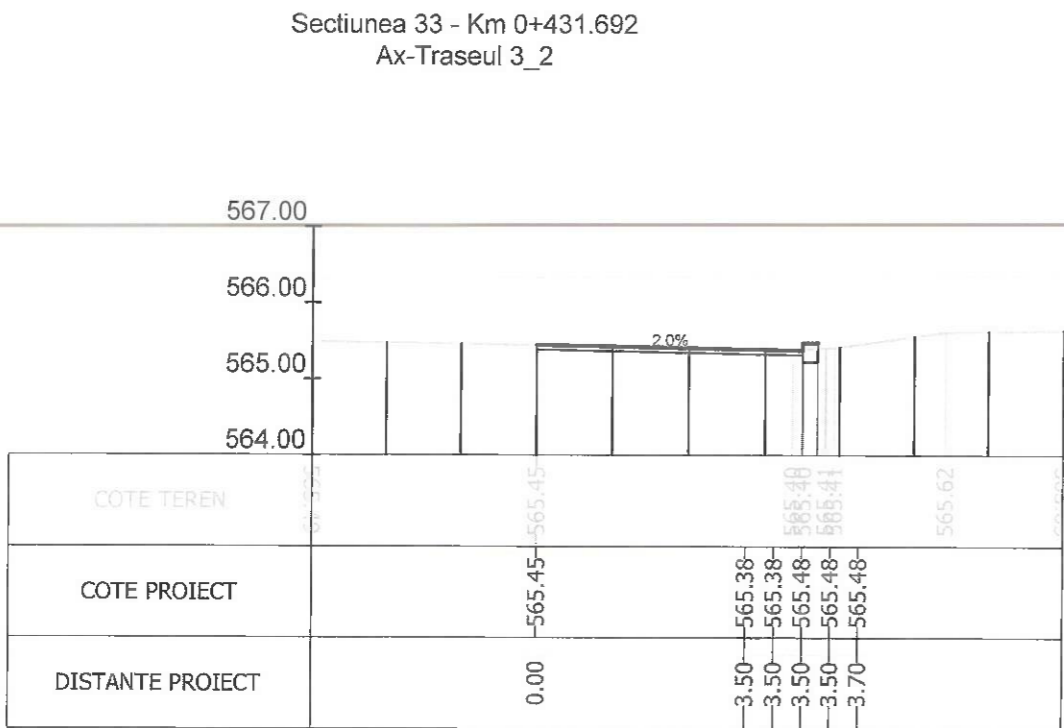

Sectiunea 34 - Km 0+450
Ax-Traseul 3_2

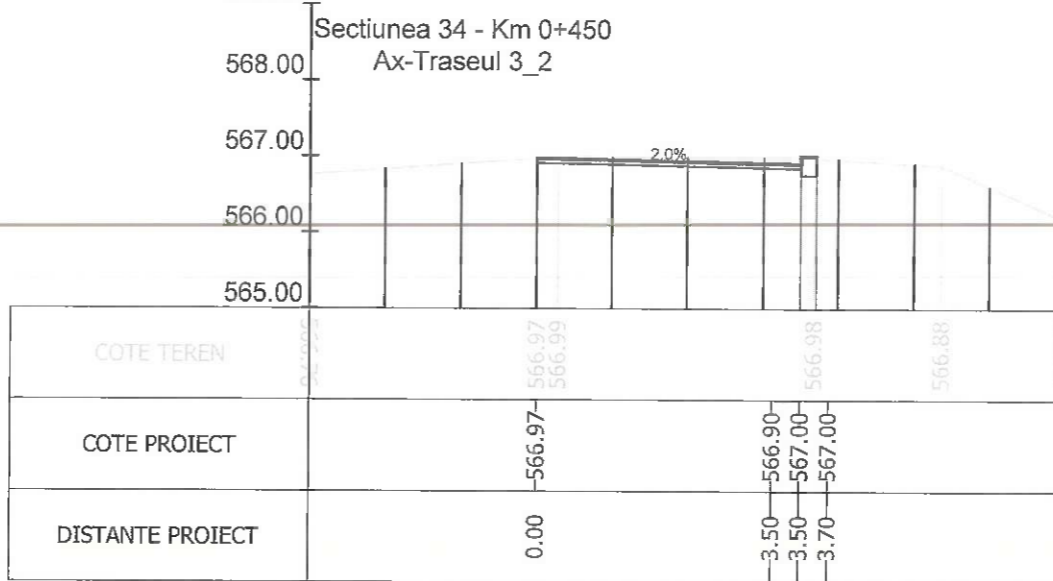

Sectiunea 35 - Km 0+460.392
Ax-Traseul 3_2

Sectiunea 36 - Km 0+475
Ax-Traseul 3_2



Index	A		Rev. 5
			Beneficiar:
Sef Proiect: Ing. A. Buta Proiectat: Ing. A. Buta Desenat: Ing. S. Patroi Verificat:			MUNICIPIUL BRASOV Bulevardul Eroilor 8, Brasov 500007
Scara: 1/100 Data: 07/2023			Nr. proiect: 73 / 2020 Faza P.T.
Titlu proiect: AMENAJARE BENZI DEDICATE TRANSPORTULUI PUBLIC IN MUNICIPIUL BRASOV SI TROTUARE ADIACENTE			Nr. plansa: PT-150
Titlu plansa: PROFILE TRANSVERSALE CURENTE			

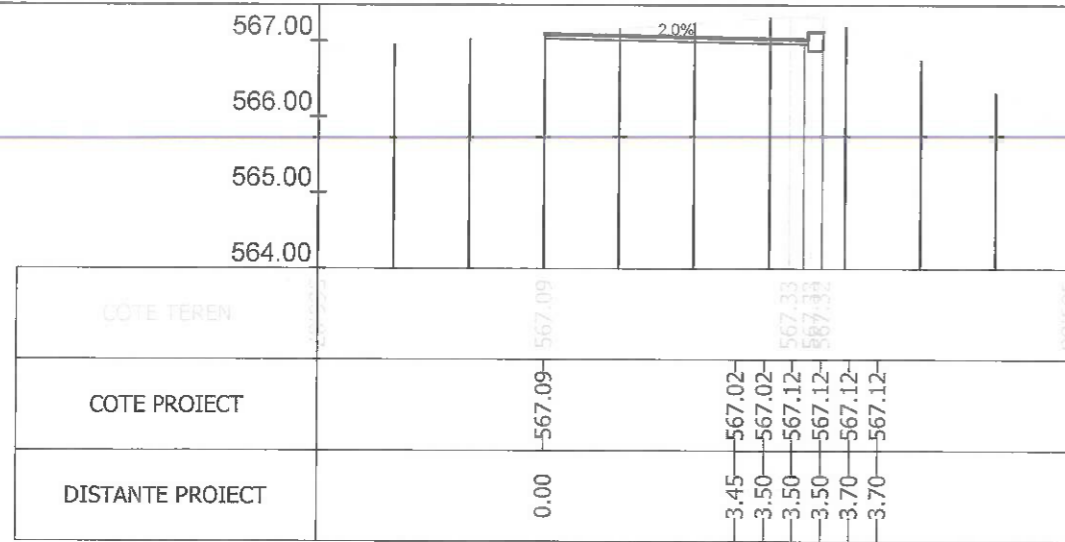

Sectiunea 37 - Km 0+478.413

Ax-Traseul 3_2

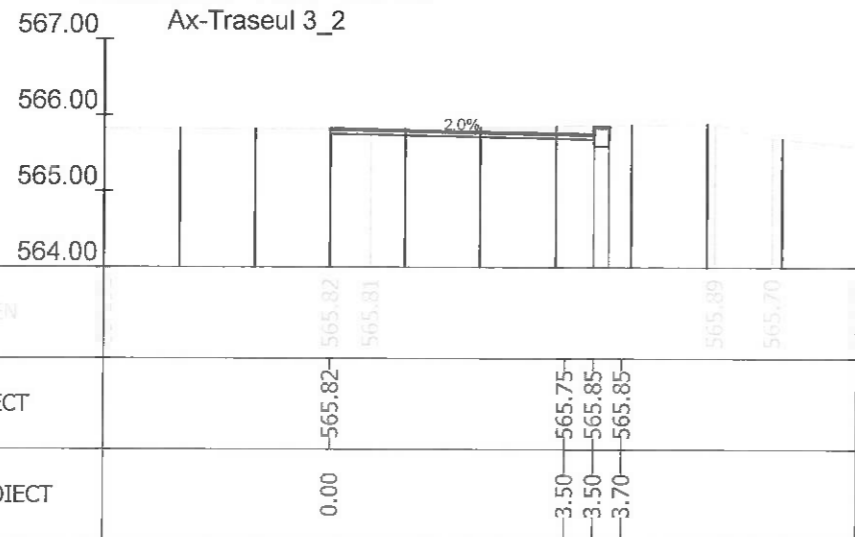

Sectiunea 39 - Km 0+500

Ax-Traseul 3_2

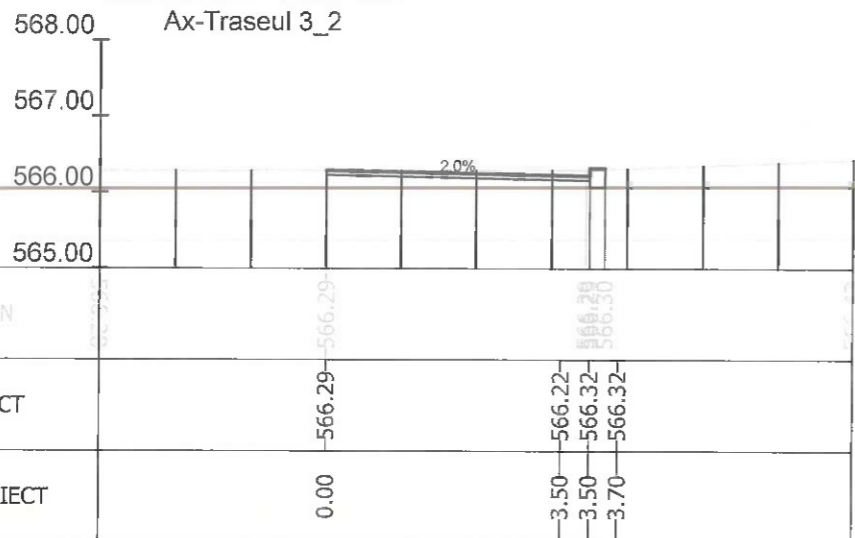

Sectiunea 41 - Km 0+525

Ax-Traseul 3_2

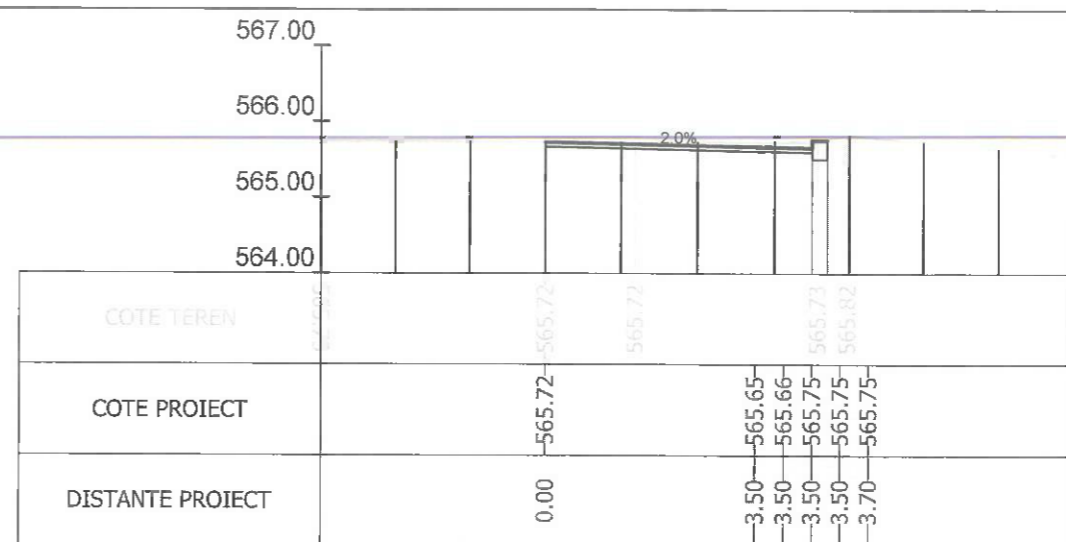

Sectiunea 38 - Km 0+494.578

Ax-Traseul 3_2

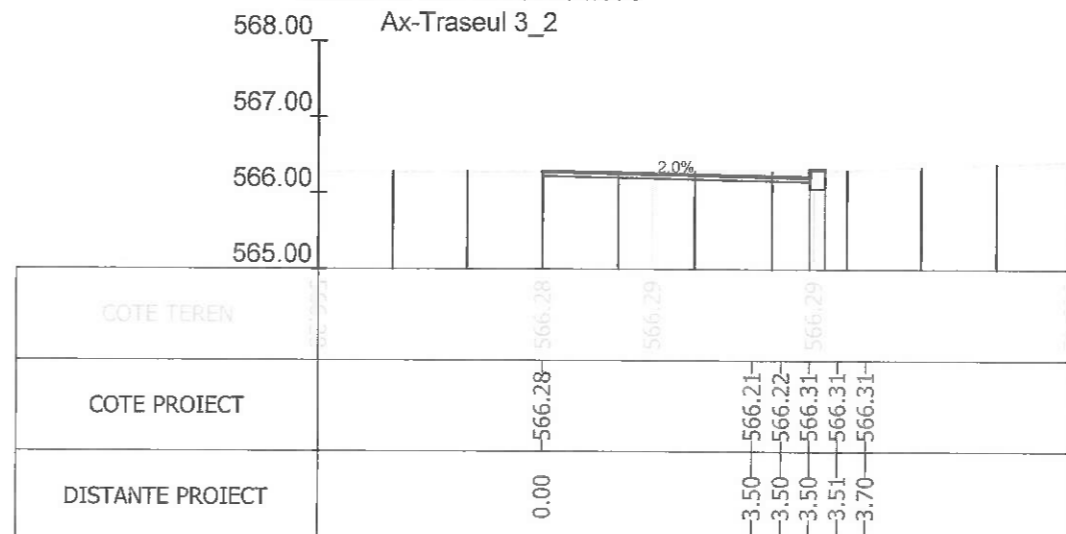

Sectiunea 40 - Km 0+524.505

Ax-Traseul 3_2

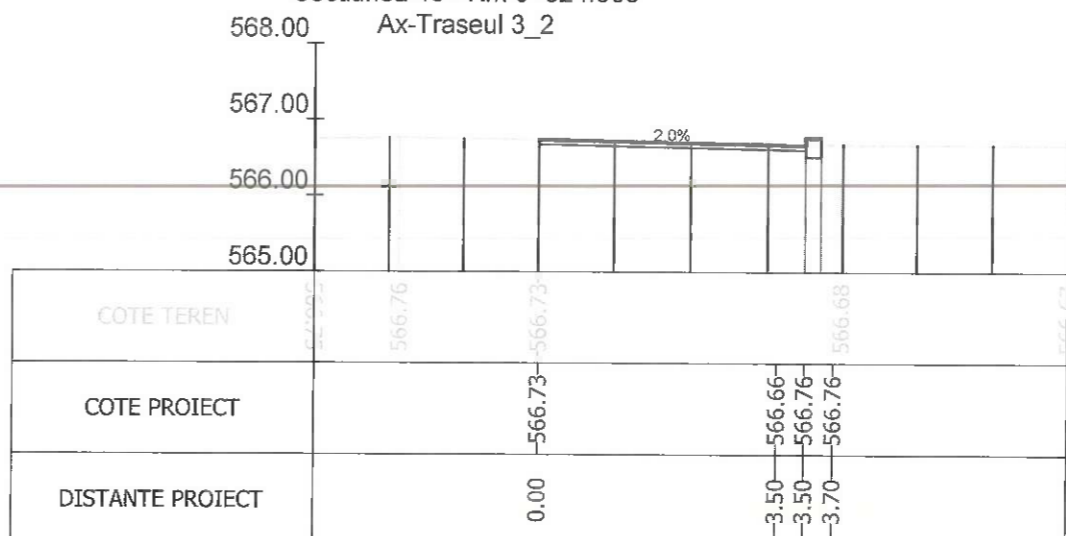

Sectiunea 42 - Km 0+550

Ax-Traseul 3_2

Index	A	Rev. 5
		Beneficiar: MUNICIPIUL BRASOV Bulevardul Eroilor 8, Brasov 500007
Sef Proiect	Ing. A. Buta	Nr. proiect: 73 / 2020
Proiectat	Ing. A. Buta	Faza: P.T.
Desenat	Ing. S. Patroi	Nr. plansa: PT-151
Verificat		
Scara: 1/100		Titlu proiect: AMENAJARE BENZI DEDICATE TRANSPORTULUI PUBLIC IN MUNICIPIUL BRASOV SI TROTUARE ADIACENTE
Data: 07/2023		Titlu plansa: PROFILE TRANSVERSALE CURENTE



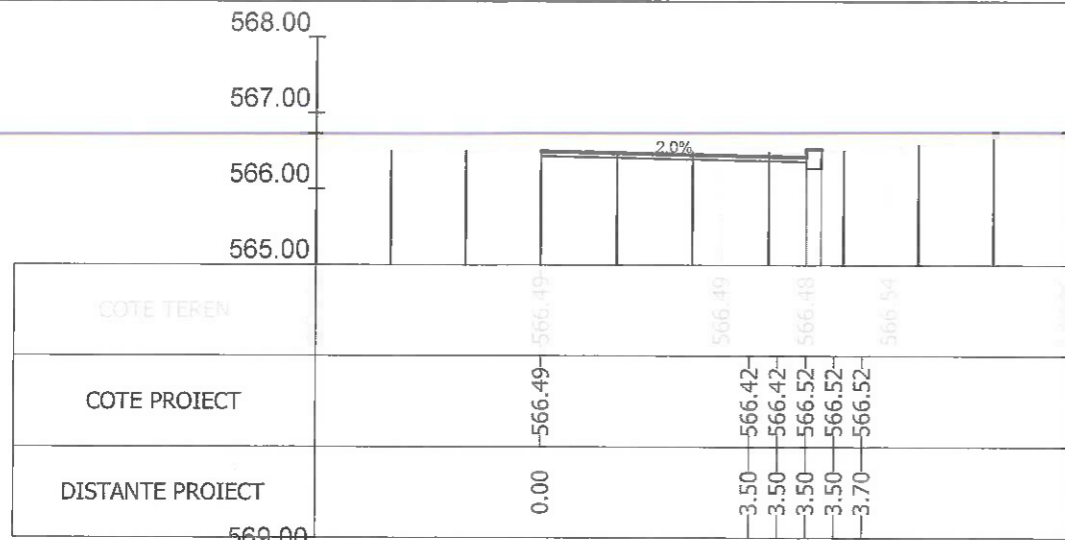

Sectiunea 43 - Km 0+565.515
Ax-Traseul 3_2

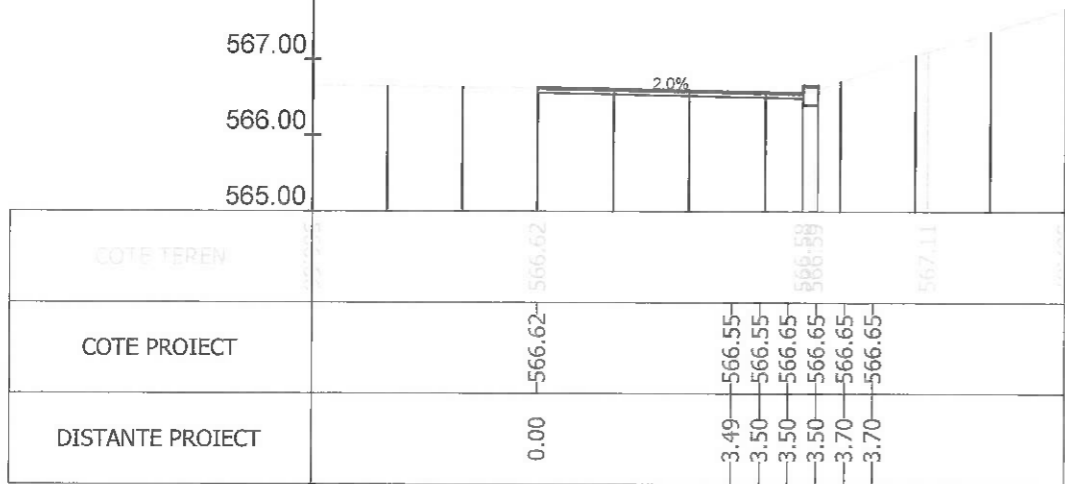

Sectiunea 45 - Km 0+575.217
Ax-Traseul 3_2

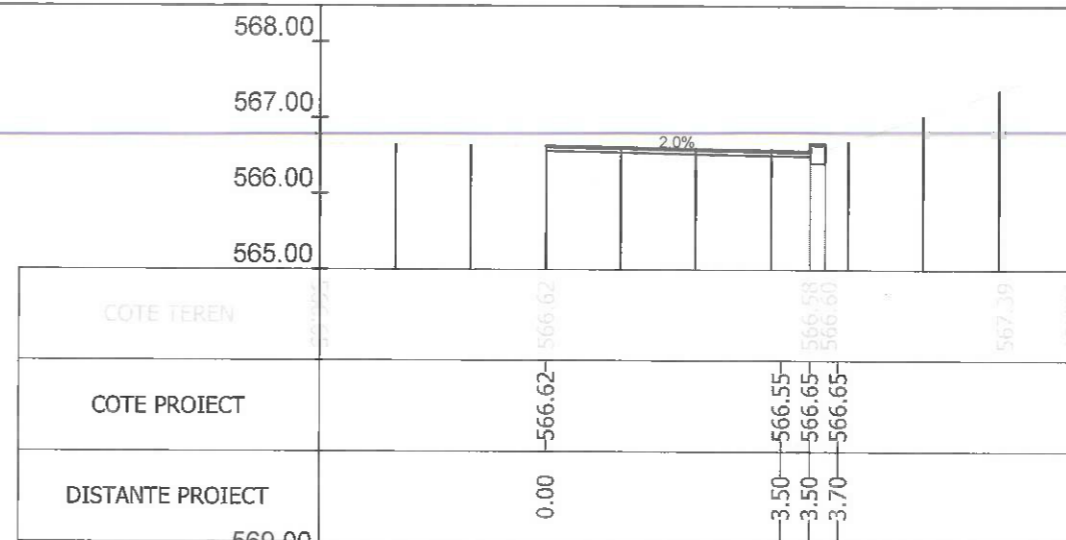

Sectiunea 44 - Km 0+575
Ax-Traseul 3_2

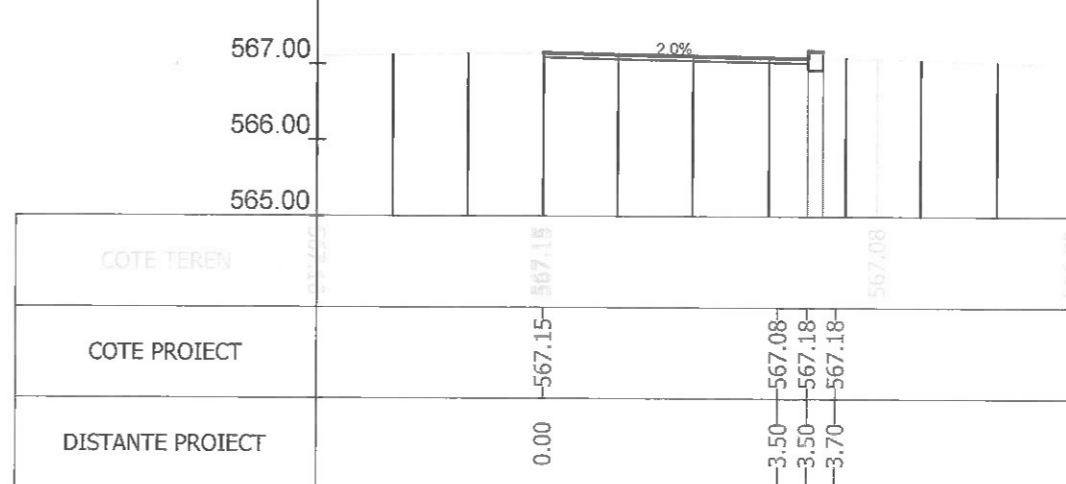

Sectiunea 46 - Km 0+600
Ax-Traseul 3_2



Index	Data	Observatii	Rev. 5
A			
		Beneficiar:	MUNICIPIUL BRASOV Bulevardul Eroilor 8, Brasov 500007
Sef Proiect: Ing. A. Buta Proiectat: Ing. A. Buta Desenat: Ing. S. Patroi Verificat:		Titlu proiect:	AMENAJARE BENZI DEDICATE TRANSPORTULUI PUBLIC IN MUNICIPIUL BRASOV SI TROTUARE ADIACENTE
Scara: 1/100 Data: 07/2023		Titlu plansa:	PROFILE TRANSVERSALE CURENTE
		Nr. proiect:	73 / 2020
		Faza:	P.T.
		Nr. plansa:	PT-152

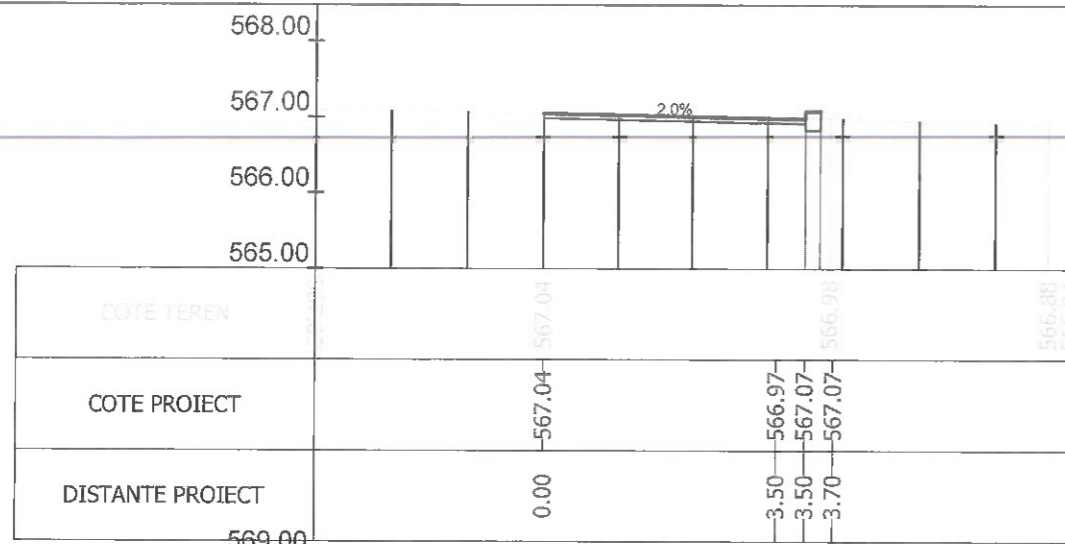

Sectiunea 47 - Km 0+603.332
Ax-Traseul 3_2

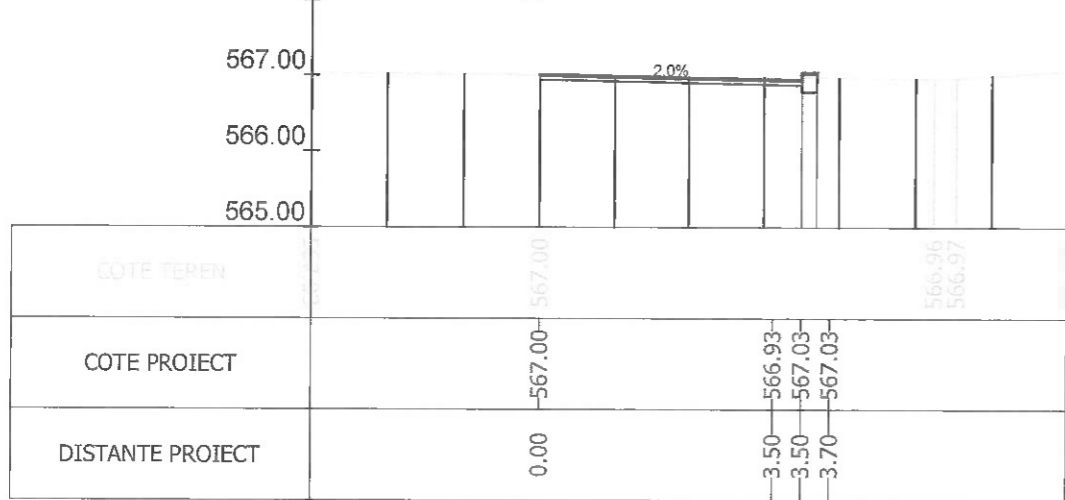

Sectiunea 49 - Km 0+625
Ax-Traseul 3_2

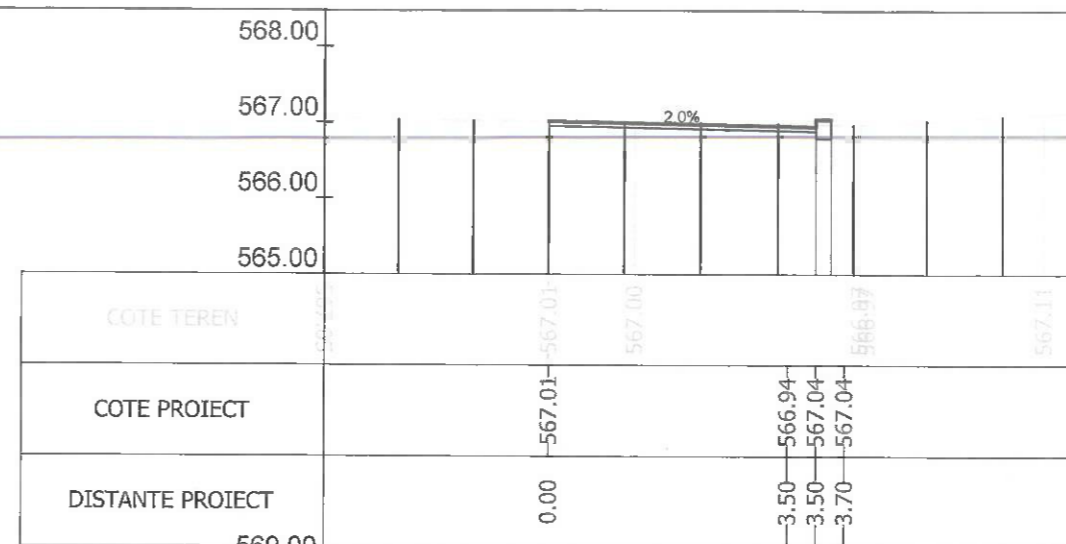

Sectiunea 48 - Km 0+618.168
Ax-Traseul 3_2

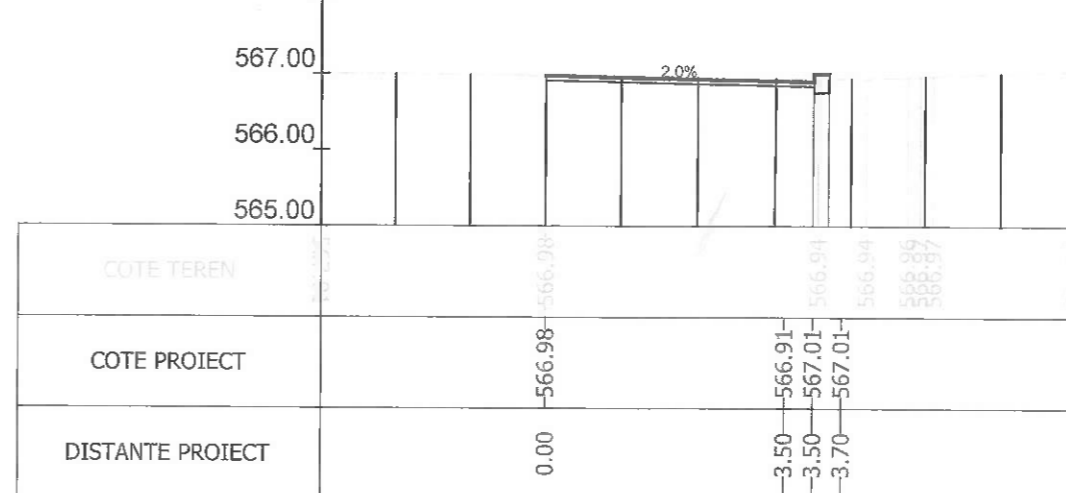

Sectiunea 50 - Km 0+633.003
Ax-Traseul 3_2



Index	Data	Observatii	Rev. 5
A			
		Beneficiar:	MUNICIPIUL BRASOV Bulevardul Eroilor 8, Brasov 500007
Sef Proiect: Ing. A. Buta Proiectat: Ing. A. Buta Desenat: Ing. S. Patroi Verificat:		Titlu proiect:	AMENAJARE BENZI DEDICATE TRANSPORTULUI PUBLIC IN MUNICIPIUL BRASOV SI TROTUARE ADIACENTE
Scara: 1/100 Data: 07/2023		Titlu plansa:	PROFILE TRANSVERSALE CURENTE
		Nr. proiect:	73 / 2020
		Faza:	P.T.
		Nr. plansa:	PT-153

DETALII MONTARE BORDURI

BORDURA CAROSABIL sc. 1:20

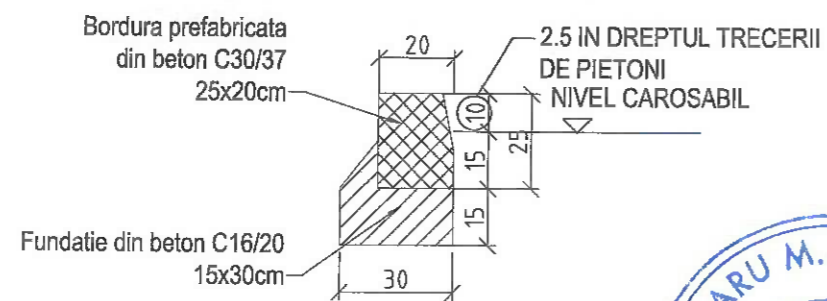

BORDURA TROTUAR sc. 1:20

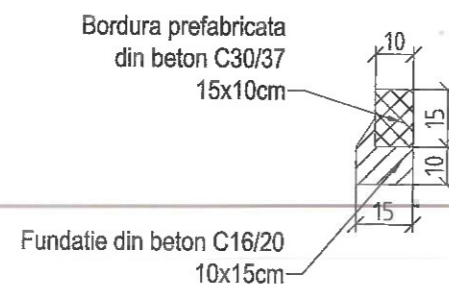

Index	Data	Observatii	Rev. 5
A			

		Beneficiar: MUNICIPIUL BRASOV Bulevardul Eroilor 8, Brasov 500007		Nr. proiect 73 / 2020
Sef Proiect Ing. A. Buta		Titlu proiect: AMENAJARE BENZI DEDICATE TRANSPORTULUI PUBLIC IN MUNICIPIUL BRASOV SI TROTUARE ADIACENTE		Faza P.T.
Proiectat Ing. A. Buta		Titlu plansa: DETALII MONTARE BORDURI		Nr. plansa D-01
Desenat Ing. S. Patroi		Scara 1/20		
Verificat		Data 07/2023		